

General Catalogue 2023 / 2024



Editorial

Panasonic – leading the way in Heating and Cooling. With 65 years of experience, selling to more than 120 countries around the world, Panasonic is one of the leaders in the heating and cooling sector.

Bringing nature's balance indoors.

nanoe™ X, technology with the benefits of hydroxyl radicals that have the capacity to inhibit pollutants, viruses, and bacteria and deodorise.



PRO Club. The professional website for Panasonic customers.

PRO Club provides useful software and tools that help design offices, installers and other professionals working in heating and cooling market.

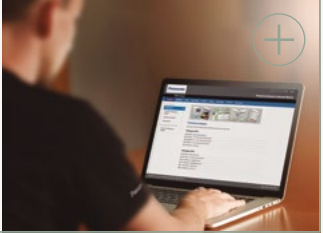

Aquarea

Aquarea is a ground breaking low energy system for heating and domestic hot water production: delivering outstanding performance, even at extreme outdoor temperatures.

New Aquarea L Generation, with natural refrigerant.

Aligning with our vision of a carbon-free society and our GREEN IMPACT plan, Aquarea L Generation is engineered with industry leading R290 natural refrigerant.



New Aquarea design; harmony between nature and home.

The indoor has been designed to blend into your interior space effortlessly. Anthracite grey outdoor unit, an architecturally sympathetic design, seamlessly integrating into any setting.



Domestic

Panasonic has developed a range of domestic products designed for you and your clients.

New Etherea: a very welcome addition to your home.

The smart, new Etherea comes with the new nanoe™ X (Generator Mark 3) and built-in Wi-Fi which enables advanced smart control and voice assistant, now with an easier and quicker set-up.



New wall-mounted TZ super-compact.

The perfect air conditioner for the smallest spaces in your home, now comes with nanoe™ X technology, to improve protection 24/7. The built-in Wi-Fi enables now an easier set-up.



Commercial air to air - PACi

The commercial range is continuously being improved to offer the optimal solutions. High performance, silent operation and a wide range of indoor units and connectivity available.

PACi NX Series.

This series for absolute ease of refurbishment. Having 3 wired power and communications makes the replacement old systems with 3 wiring connections simple and easy.



CONEX. Devices and apps.

CONEX provides comfort and control for varying user needs. Accessible, flexible and scalable with different controllers and apps. Perfectly meeting requirements of modern controls for end user, installer and service.

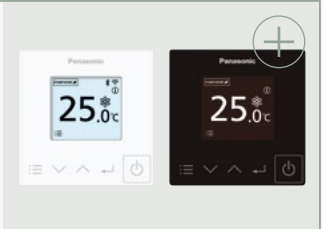

Commercial VRF Systems - ECOi and ECO G

Panasonic provides an extensive range of solutions for medium and large sized buildings, combining the best options to satisfy all needs and site restrictions.

Mini ECOi LZ2 Series R32.

Outstanding efficiency in a compact body and continuous operation even at extreme ambient temperatures.

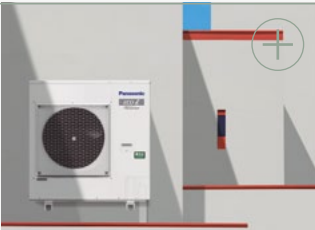

nanoe™ X.

nanoe™ X is a perfect solution to improve indoor air quality in your commercial environment. Taking the benefits of hydroxyl radicals, indoor environment can be a cleaner and more pleasant place to be, whether at work, hotels, shops and restaurants etc.



Ventilation

Panasonic ventilation solutions for maximum savings and easy integration.



Air handling unit connection kit for PACi, ECOi and ECO G.

Air handling unit (AHU) connection kit connects outdoor units to air handling systems. Combines air conditioning and fresh air in just one solution.



Energy recovery ventilation.

Panasonic energy recovery ventilations (ERV) help to improve your comfort and energy saving plan. Introducing new ERV range (ZY1G) which has extended line-up and comes with F7 grade filter as a standard.



Control and connectivity

From the individual remote controller for the residential single units up to the newest technology capable of controlling your building anywhere in the world.



Panasonic AC Smart Cloud.

Panasonic AC Smart Cloud provides building mapping, remote monitoring, error notification and schedule setting for site managers. Panasonic AC Service Cloud help maintenance companies to manage multiple sites with remote checking and advance failure prediction functions.

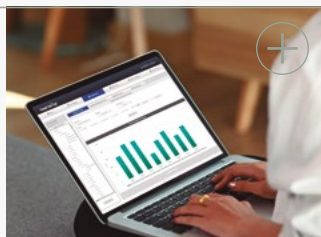

Panasonic AC Service Cloud.

Panasonic AC Service Cloud provides to maintenance company a unique tool to deliver advanced maintenance to increase response time, reduce sites visits and allocate better the resources.

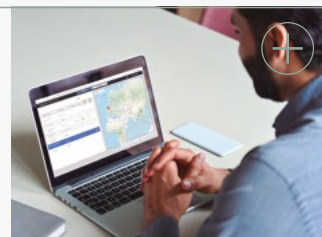

Cooling only and heat pumps chillers - ECOi-W

ECOi-W provides the optimal performance in any climatic condition. Meeting customer's needs with fully customisable solution at hotels, offices and industries.



ECOi-W R32 cooling only and heat pumps chillers.

Sustainable chiller solutions with R32 refrigerant to suit a variety of commercial and industrial applications.



New cascade control - Plug & Play solution.

All necessary components are included just to be ready for the use on site. A smart control for cascade systems up to 8 ECOi-W outdoor units, also integrated with ECOi-W Cloud.



Refrigeration

Panasonic CO₂ condensing units - CR Series with natural refrigerant. Natural refrigerant solution for showcases and cold rooms. Reliable quality - made in Japan.



Refrigeration.

CR Series is an ideal solution for supermarkets, convenience stores and gas stations. Let's choose the sustainable green solution by Panasonic.

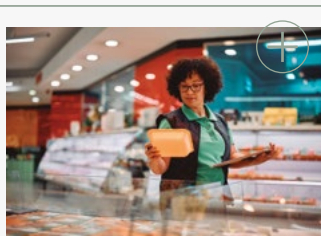

Reliable CO₂ technology by Panasonic.

CR Series are made in Japan with an excellent quality control established by skilled factory team. 2-stage rotary compressor by Panasonic delivers powerful performance more than 20 years and spit cycle technology enhances cooling effect.



Dimensions



Wiring diagrams



Quality Management System Certificate



ISO 9001: 2015
Panasonic Appliances Air-Conditioning
Malaysia. Sdn.Bhd.
Cert. No.: QMS 00413

GB/T 19001-2016/ISO 9001: 2015
Panasonic Appliances Air-Conditioning
(GuangZhou) Co., Ltd.
Registration Number: 01218Q30835R8L

Environmental Management System Certificate



ISO 14001: 2015
Panasonic Appliances Air-Conditioning
Malaysia Sdn.Bhd.
Cert. No.: EMS 00109

GB/T 24001-2016/ISO 14001: 2015
Panasonic Appliances Air-Conditioning
(GuangZhou) Co., Ltd.
Registration Number: 02118E10944R7M

Panasonic environmental vision 2050

To achieve “a better life” and “a sustainable global environment,” Panasonic will work towards creation and more efficient utilisation of energy which exceeds the amount of energy used, aiming for a society with clean energy and a more comfortable lifestyle.

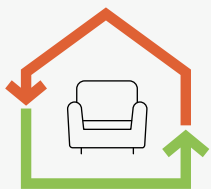

Energy used < Energy created

One initiative in the Panasonic environmental vision 2050 is offering products with greater energy efficiency. In 2018, we celebrated the 60th anniversary of our Heating & Cooling Solutions business. Our expertise gained over the years has helped us launch a range of products that contribute to a more carbon-free society.

Current status of energy used and energy created

Energy used by Panasonic business activities and products.



Clean energy created and / or made available by Panasonic products, etc.

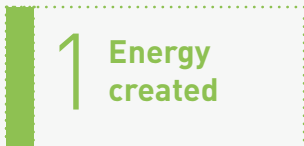

Working to realise environmental vision 2050

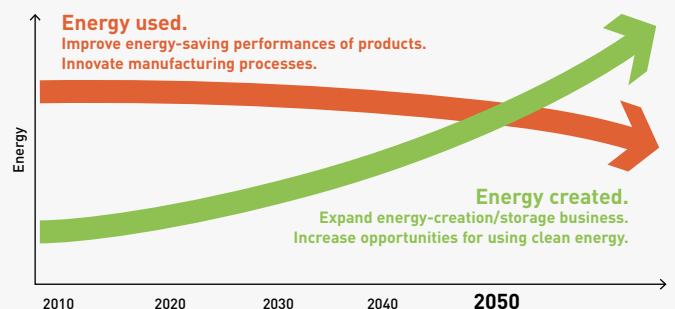

Projects and case studies

Panasonic, a partner with the knowledge and experience to achieve your objectives, both at country and international level by implementing them both on-time and on-budget. Solutions that reduce costs, whilst also being efficient, green, user-friendly, reliable and innovative.

As a global company, we have at our disposal the financial, logistical and technical resources to develop complex and wide-ranging solutions, both at country and international level by implementing them both on-time and on-budget.



Belfast Grand Opera House.
Public building.
Belfast, United Kingdom.
PACi, VRF and Control.



Varna Wave Building.
Residential building.
Varna, Bulgaria.
Aquarea and Aquarea Smart Cloud.



Passivhouse in Miño.
Residential passive house.
Miño, Spain.
Aquarea.



Flumen Plus.
Residential passive house building.
Zaragoza, Spain.
PACi.

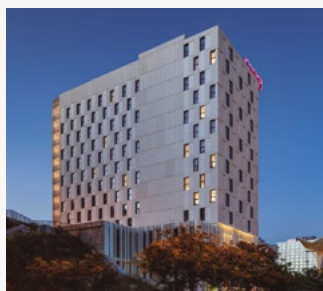

Hotel Moxy Oriente.
Hotel.
Lisboa, Portugal.
PACi, VRF and Control.



Gutenfels.
Hotel.
Kaub, Germany.
Aquarea and Aquarea Smart Cloud.



Maison Tirel Guerin.
Hotel- Restaurant.
Saint Méloir-des- Ondes, France.
Mini ECOi.



Crosslight House.
Residential building.
Mulazzano, Italy.
PACi and nanoe™ X.



Gurewicz Spa Resort.
Hotel- Restaurant - Spa.
Otwock, Poland.
PACi, VRF and Control.



Nobelhorst.
Residential building.
Almere, Nederland.
Aquarea.



Amandiers.
Sports complex.
Carrierre sur Seine, France.
ECOi-W.



Hungarian Cédrus Liget. A complex facility including apartments, offices and commercial units.
Szeged, Hungary.
ECOi-W, ECOi and ERV.



Stemcell Technologies.
Global biotechnology company.
Saint-Egrève, France.
Refrigeration.

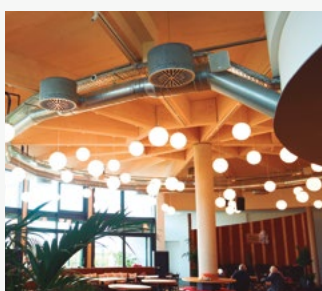

Weinbuch Butcher's Shop.
Shop - Restaurant.
Öpfingen. Germany.
VRF, Domestic and Refrigeration.



Pervalkos Jūra.
Residential.
Pervalka, Lithuania.
Aquarea.



Thon Hotel Harstad.
Hotel.
Harstad, Norway.
PACi, VRF and Refrigeration.

A desire to create things of value



"Recognising our responsibilities as industrialists, we will devote ourselves to the progress and development of society and the well-being of people through our business activities, thereby enhancing the quality of life throughout the world."
Panasonic Corporation's Basic Management Objective, formulated in 1929 by the company's founder, Konosuke Matsushita.



1958
First room air conditioner launched for domestic installation.

1975
Panasonic becomes one of the first Japanese air conditioner manufacturers in Europe.

1985
Introduces first GHP (gas heat pump) VRF air conditioner.

2008
World's first air conditioner equipped with nanoe™.

1971
Starts production of absorption chillers.

1982
Panasonic launches the first highly efficient air to water heat pump in Japan.

1989
Introduces world's first simultaneous 3-Pipe heating / cooling VRF System.

2010
New Aquarea. Panasonic introduces Aquarea, an innovative new, low-energy system in Europe.

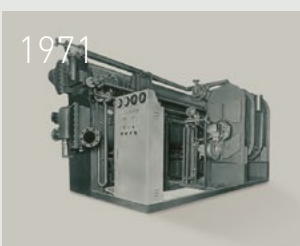

Vitalize the future with air

These are times of exceptional challenge.

If the world is to move forward confidently, it must overcome the serious threats of the new global pandemics and the degrading of the environment. It must find ways large and small to reduce the stresses that affect people's health and the stability of their communities.

At Panasonic, we're utilizing the power of air to create positive change.

Air that benefits body and mind.

Air that energizes the places where people gather to work and play.

Air that reduces our burden on the Earth.

With more than a century of research and expertise to guide us, we're using air to open a more hopeful and vital future for all.



2012
New Panasonic GHP units. The gas-driven VRF Systems are ideal for projects where power restrictions apply.

2016
New VRF Systems ECOi EX with extraordinary energy saving performance.

2019
Panasonic introduces a new Chiller Series which is named as ECOi-W.

2021
Mini VRF R32 up to 10 HP. Outstanding efficiency in a compact body.

2023
Aquarea Heat Pumps with natural refrigerant R290.

2015
CO₂ condensing units in Europe. The ideal solution for supermarkets, shops and gas stations.

2018
The first Hybrid System with VRF and GHP in Europe. — Opening heat pump production line in Czech Republic, Europe.

2020
nanoe™ X, technology with the benefits of hydroxyl radicals. Improving protection 24/7. Built-in nanoe™ X technology expanded to commercial solutions.

2022
ECOi-W R32, the new range of sustainable chiller solutions to suit a variety of commercial and industrial applications.

Looking ahead



Bringing nature's balance indoors



nanoe™ X, technology with the benefits of hydroxyl radicals.

In today's health-conscious world, we care about taking exercise, we care about what we eat and what we touch, we also care about what we breathe – and technology exists to bring good outdoor air, indoors.



Abundant in nature, hydroxyl radicals (also known as OH radicals) have the capacity to inhibit pollutants, viruses, and bacteria to clean and deodorise. nanoe™ X technology can bring these incredible benefits indoors so that hard surfaces, soft furnishings, and the indoor environment can be a cleaner and more pleasant place to be, whether at home, work, or visiting hotels, shops and restaurants etc.

A naturally occurring process

Hydroxyl radicals are unstable molecules looking to react with other elements like hydrogen, capturing it. Thanks to this reaction, hydroxyl radicals have the potential to inhibit the growth of pollutants such as bacteria, viruses, moulds, and odours, breaking them down and neutralising the unpleasant effects. This naturally occurring process has major benefits to improve indoor environments.



Hydroxyl radicals in nature.

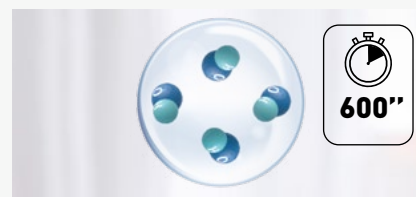

Hydroxyl radicals contained in water.

By creating hydroxyl radicals contained in water, nanoe™ X technology significantly boosts their effectiveness, increasing hydroxyl radicals lifetime from less than a second in nature, to more than 600 seconds – 10 minutes so that nanoe™ X can spread easily around the room.

Panasonic's nanoe™ X technology takes this a step further and brings nature's detergent – hydroxyl radicals – indoors to help create an ideal environment

Thanks to the nanoe™ X properties, several types of pollutants can be inhibited such as certain types of bacteria, viruses, mould, allergens, pollen and certain hazardous substances.

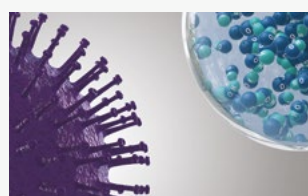

1 | nanoe™ X reliably reaches pollutants.



2 | Hydroxyl radicals denature pollutants' proteins.



3 | Pollutants activity is inhibited.

The well-being benefits of nature are well known – but do you know the power of hydroxyl radicals?

What is unique about nanoe™ X?

Hydroxyl radicals inhibit pollutants, certain types of viruses, and bacteria to clean and deodorise. Thanks to this advanced technology, even tightly woven fabrics can be treated using this solution, meaning that curtains, blinds, carpets and furniture can all benefit from this technology to inhibit hazardous substances – including on hard surfaces and, of course, the air that we breathe.



Effective on fabrics and surfaces.

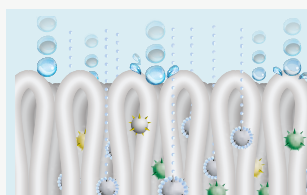

1 | At one billionth of a metre, nanoe™ X is much smaller than steam and can deeply penetrate cloth fabrics to deodorise.

Longer lifespan.



2 | Contained in tiny water particles, nanoe™ X has a long lifespan, which is about 600 seconds, to spread easily around the room.

Huge quantity.



3 | nanoe X Generator Mark 2 produces 9,6 trillion hydroxyl radicals per second. Greater amounts of hydroxyl radicals contained in nanoe™ X lead to higher performance on inhibition of pollutants.

Maintenance-free.

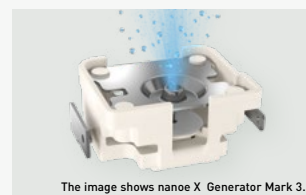

The image shows nanoe X Generator Mark 3.

4 | No service and maintenance required. nanoe™ X is a filter free solution that does not require maintenance, as its atomisation electrode is enveloped with water during its generation process and it is made with Titanium.

7 effects of nanoe™ X – Panasonic unique technology

Deodorises

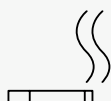

Odours

Capacity to inhibit 5 types of pollutants



Bacteria and viruses



Mould

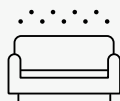

Allergens



Pollen



Hazardous substances



Skin and hair

* Refer to <https://aircon.panasonic.eu> for more details and validation data.

The latest nanoe™ X device uses a “multi-leader discharge” system that focuses the discharge to 4 needle-shaped electrodes, greatly expanding the hydroxyl radicals.

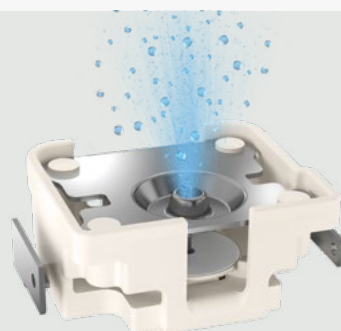

The image shows nanoe X Generator Mark 1.

How nanoe™ X is generated.

- 1 | Atomised electrode produces condensation
- 2 | Electrical discharge is applied to the water
- 3 | nanoe™ X particles are generated

nanoe™ X, internationally-validated technology in testing facilities.

The effectiveness of nanoe™ X technology has been tested by 3rd party laboratories in Germany, France, Denmark, Japan and China.

The nanoe™ X performance varies depending on the room size, environment and usage and it may take several hours to reach the full effect. nanoe™ X is not medical device, local regulations on building design and sanitary recommendations must be followed. Test results conducted under controlled laboratory conditions. Performance of nanoe™ X might differ in real life environment.

Panasonic heat pump with nanoe™ X technology verified against SARS-CoV-2

Virus SARS-CoV-2: 91,4% inhibited. Test conducted by TEXCELL (France), using a gauze saturated with SARS-CoV-2 virus solution exposed to Panasonic heat pump with nanoe™ X in a space of 6,7 m³ over 8 hours. Test report: 1140-01 C3. Performance of nanoe™ X might differ in real life environment.

	Tested contents	Generator	Result	Capacity	Time	Testing organisation	Report No.	
Airborne	Virus	Influenza (H1N1)	Mark 2	98,3% inhibited	30 m ³	1,5 h	China Electronic Product Reliability and Environmental Testing Research Institute	J2003WT8888-00889
		Bacteriophage ΦX174	Mark 1	99,7% inhibited	Approx. 25 m ³	6 h	Kitasato Research Center for Environmental Science	24_0300_1
	Bacteria	Staphylococcus aureus	Mark 1	99,9% inhibited	Approx. 25 m ³	4 h	Kitasato Research Center for Environmental Science	2016_0279
Adhering	Virus	SARS-CoV-2	Mark 1	91,4% inhibited	6,7 m ³	8 h	Texcell (France)	1140-01 C3
		SARS-CoV-2	Mark 1	99,9% inhibited	45 L	2 h	Texcell (France)	1140-01 A1
		Bacteriophage ΦX174	Mark 1	99,8% inhibited	Approx. 25 m ³	8 h	Japan Food Research Laboratories	13001265005-01
		Xenotropic murine leukemia virus	Mark 1	99,999% inhibited	45 L	6 h	Charles River Biopharmaceutical Services GmbH	—
		Coxsackie virus (CA16)	Mark 2	99,9% inhibited	30 m ³	4 h	China Electronic Product Reliability and Environmental Testing Research Institute	J2002WT8888-00439
	Bacteria	Staphylococcus aureus	Mark 1	99,9% inhibited	20 m ³	8 h	Danish Technological Institute	868988
	Pollen	Cedar	Mark 2	99% inhibited	23 m ³	12 h	Panasonic Product Analysis Center	L19YA009
		Ambrosia pollen	Mark 1	99,4% inhibited	20 m ³	8 h	Danish Technological Institute 868988	868988
	Odours	Cigarette smoke odour	Mark 1	Odour intensity reduced by 2,4 levels	Approx. 23 m ³	0,2 h	Panasonic Product Analysis Center	4AA33-160615-N04

First nanoe™ device was developed by Panasonic in 2003

Introducing nanoe X Generator Mark 3, the latest of the continuously evolving nanoe™ X technology, it has the largest amount of hydroxyl radical in the history of nanoe™ which generates 48 trillion hydroxyl radical per second, 100 times the hydroxyl radical contained in traditional nanoe™. The increased number of hydroxyl radical, which are the key to nanoe™ effectiveness, means you can expect an even higher level of performance (effective against bacteria, viruses, mould, PM2.5, allergens and odors).

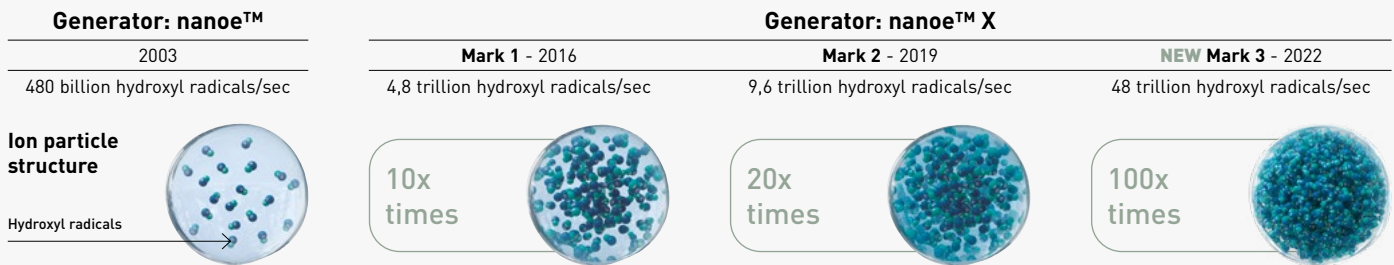

Effectiveness in large space with Generator Mark 3

Inhibits virus.

An air conditioner equipped with nanoe X Generator Mark 3 inhibits activity of adhered virus (Bacteriophage) by 98,81% in 4 hours ¹⁾.

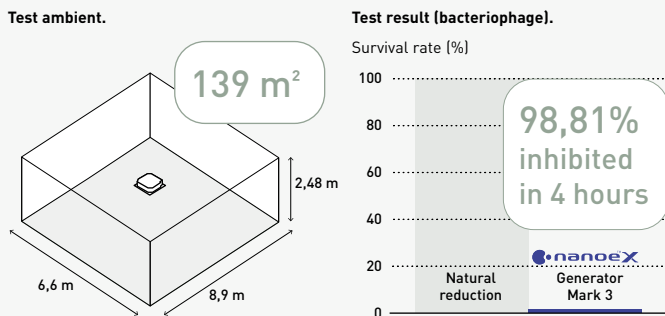

Inhibits pollen.

The result of nanoe X Generator Mark 3.

Inhibits pollen in 1/4 the time of nanoe X Generator Mark 2 ²⁾.

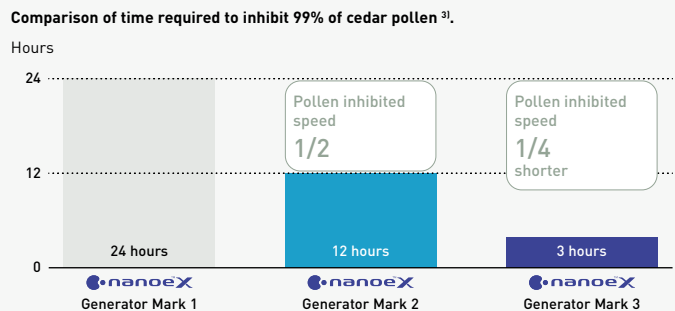

1) Testing organisation: SGS Inc / Test subject: Adhered Bacteriophage / Test volume: Approx. 139 m³ large space (6,6 x 8,9 x 2,48 m). Test result: Inhibited 98,81% in 4 hours. Test report no.: SHES210901902583.
 2) Effect after 3 hours in a test space of approx. 24 m³. The figures are not the results of testing in an actual operating space. 3) nanoe X Generator Mark 1: [Testing organisation] Panasonic Product Analysis Center [Test method] ELISA method of measuring allergens adhering to fabric in a test room (approx. 24 m³) [Method of inhibition] Release of nanoe™ [Target] Adhered allergen (cedar pollen) [Test Result] Inhibition of 99% or more in 24 hours (AAA33-151001-F01). nanoe X Generator Mark 2: [Testing organisation] Panasonic Product Analysis Center, [Test method] ELISA method of measuring allergens adhering to fabric in a test room (approx. 24 m³) [Method of inhibition] Release of nanoe™ [Target] Adhered allergen (cedar pollen) [Test Result] Inhibition of 99% or more in 12 hours confirmed (L19YA009). nanoe X Generator Mark 3: [Testing organisation] Panasonic Product Analysis Center [Test method] ELISA method of measuring allergens adhering to fabric in a test room (approx. 24 m³) [Method of inhibition] Release of nanoe™ [Target] Adhered allergen (cedar pollen) [Test Result] Inhibition of 99% or more in 3 hours (H21YA017-1).

Where is nanoe™ X technology used?

Since 2003, nanoe™ has become a part of people's lives in Japan and other regions.

Such technology can be found in diverse applications for cleaning air and surfaces, inside trains, elevators, cars, home appliances and personal beauty ... as well as in air conditioning.

Panasonic Heating & Cooling Solutions is incorporating nanoe™ technology in a wide range of equipment for residential applications as well as for commercial spaces and, it is a solution that does not require filters or maintenance and can work independently from heating or cooling.

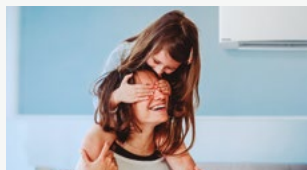

Home



Shop



Gym



Hotel



Office



Clinic

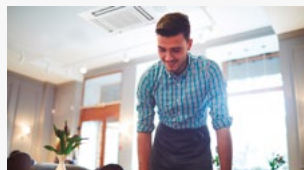

Restaurant



Hospital

It has been adopted in people's homes as well as in public facilities where improved air quality is desired, such as offices, hospitals, healthcare centres and hotels etc.

nanoe™ X: improving protection 24/7



Panasonic Heating & Cooling Solutions is incorporating nanoe™ technology in a wide range of equipment

Home.

Built-in nanoe X Generator Mark 3.



Wall-mounted Etherea.
CS-XZ**ZKEW-H.
4 capacities: 2,0 - 4,2 kW.
CS-XZ**ZKEW.
4 capacities: 2,0 - 5,0 kW.
CS-(M)Z**ZKE(W).
7 capacities: 1,6 - 7,1 kW.

Built-in nanoe X Generator Mark 2.



Aquaarea EcoFlex ducted unit.
S-71WF3E.

Built-in nanoe X Generator Mark 1.



Wall-mounted TZ super-compact.
CS-(M)TZ**ZKE(W).
8 capacities: 1,6 - 7,1 kW.



Floor console.
CS-Z**UFEAW.
4 capacities: 2,0 - 5,0 kW.

Built-in nanoe™.



Wall-mounted VZ Heatcharge.
CS-VZ**SKE.
2 capacities: 2,5 - 3,5 kW.

Commercial.

PACi NX. Built-in nanoe X Generator Mark 1.



4 way 90x90 cassette - PU3.
S-****PU3E.
7 capacities: 3,6 - 14,0 kW.

PACi NX. Built-in nanoe X Generator Mark 2.

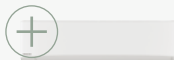

Wall-mounted - PK3.
S-****PK3E.
5 capacities: 3,6 - 10,0 kW.



4 way 60x60 cassette - PY3.
S-***PY3E.
4 capacities: 2,5 - 6,0 kW.



Ceiling - PT3.
S-****PT3E.
7 capacities: 3,6 - 14,0 kW.



Adaptive ducted unit - PF3.
S-****PF3E.
7 capacities: 3,6 - 14,0 kW.

VRF. Built-in nanoe X Generator Mark 3.



U2 type 4 way 90x90 cassette.
S-***MU2E5BN (Mark 3).
S-***MU2E5B (Mark 2).
11 capacities: 2,2 - 16,0 kW.



Y3 type 4 way 60x60 cassette.
S-**MY3E.
6 capacities: 1,5 - 5,6 kW.



F3 type adaptive duct.
S-***MF3E5BN / AN (Mark 3).
S-***MF3E5B / A (Mark 2).
12 capacities: 1,5 - 16,0 kW.

VRF. Built-in nanoe X Generator Mark 1.



G1 type floor console.
S-**MG1E5N.
5 capacities: 2,2 - 5,6 kW.

Ventilation. Built-in nanoe X Generator Mark 1.



Ceiling mounted air-e.
FV-15CSD1G.
1 capacity.

nanoe™ X: improving protection 24/7

100% Panasonic, the DNA of Japanese craftsmanship

Applying advanced technologies that truly make life better, we live by an unparalleled commitment to product quality.

Panasonic is building on the Japanese tradition of uncompromising quality control worldwide, developing and manufacturing fine products and delivering them to customers everywhere.



At Panasonic, we believe that the best air conditioner is one that works quietly and effectively in the background whilst minimising its impact on the environment.

People who use our products can look forward to long years of high-quality performance without the need for constant service. As part of our rigorous design and development process, Panasonic air conditioners undergo a variety of stringent tests to ensure their effectiveness and long-term reliability. Tests for durability, waterproofing, shock resistance, and noise are conducted on component parts or on the finished products themselves.

As a result of all of these time consuming efforts, Panasonic air conditioners meet industrial standards and regulations in every country where they are sold.

International Standard Quality

To uphold the company's reputation around the world, Panasonic strives continuously to offer quality with minimized environmental impact.



Reliable parts that meet or exceed industrial standards.

In every country where they are sold, Panasonic air conditioners comply with all required industrial standards and regulations. In addition, Panasonic conducts stringent testing to ensure the reliability of parts and materials. The strength of the resin material used in a propeller fan is confirmed by a tension test.



Compliance with RoHS / REACH substance restrictions.

Panasonic products and used materials strictly comply with chemical substance restrictions as defined by RoHS or REACH. During the development and production of parts, stringent inspections are conducted on over 100 materials to ensure that no hazardous substances are included.



Sophisticated production process.

Panasonic's air conditioner production lines employ state-of-the-art factory automation technologies to ensure products are manufactured with high attention to quality to meet expectations of reliability and trustworthiness.

Durability

At Panasonic we know the importance of a long service life with minimal maintenance. That's why we subject our air conditioners to a wide range of stringent durability tests.



Long-term durability test.

To ensure durability and stable operation for many years, we conduct a long-term continuous operation test under conditions that are much more severe than actual operating conditions.



Compressor reliability test.

After the continuous operation test, we remove the compressor from a selected outdoor unit, disassemble it, and examine the internal mechanisms and parts for potential failure. This helps ensure reliable long-term performance under harsh conditions.

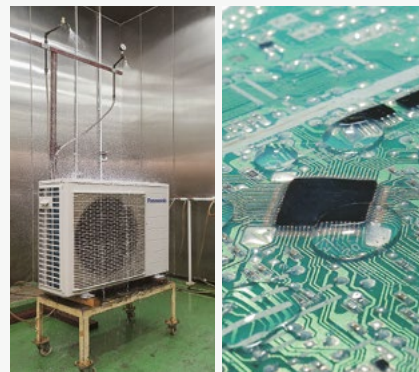

Waterproofing test.

The unit - which is subject to rain and wind - complies with IPX4 waterproof specifications. Contact sections on printed circuit boards are resin-potted to prevent adverse effects caused by exposure to water (an unlikely occurrence).

A globally trusted air conditioning brand

Panasonic – leading the way in Heating and Cooling.

With more than 50 years of experience, selling to more than 120 countries around the world, Panasonic is one of the leaders in the heating and cooling sector.

With a diverse network of production and R&D facilities, Panasonic delivers innovative products incorporating cutting-edge technologies that set the standard for air conditioners worldwide.



From, for and by Europe.

In 2018 Panasonic initiated the production of air to water heat pumps in its factory in Pilsen, Czech Republic. Keeping an excellent combination of highly skilled human resources and production automation the big demand growth foreseen in Europe can be met with outstanding quality standards.



Factory in Pilsen, Czech Republic.

More than 40 years of experienced organization in Europe.

At Panasonic, we know that the best is always yet to come. This is why our air conditioning and heat pump solutions are constantly upgraded. Panasonic is committed to offering our customers innovative products in the heating and cooling market across Europe, and has the ambition to not only meet but also exceed their requirements. Our Technology and Design teams anticipate the needs of tomorrow. We look to produce smaller, quieter, efficient solutions - with better technological features - that can reduce energy consumption while providing suitable temperature conditions for the user.

Panasonic R&D Center Germany GmbH.

The European Research and Development Center of Panasonic focusing on technology development for intelligent and environmentally friendly future products, such as audio video, communication and energy solutions.



Panasonic R&D Center Germany GmbH.

43 Training Center in 22 countries in Europe

The Panasonic PRO Academy.

Heating and Cooling business is changing rapidly, new technologies, new regulations, new solutions that require continuous update for professionals. Panasonic takes its responsibility to its distributors, specifiers and installers seriously and has developed a comprehensive training programme with 43 Training Center in 22 countries in Europe.



- Factory
- Training Center
- Sales

PRO Club. The professional website of Panasonic

Panasonic has an impressive range of support services for designers, specifiers, engineers and distributors working in the heating and cooling markets.

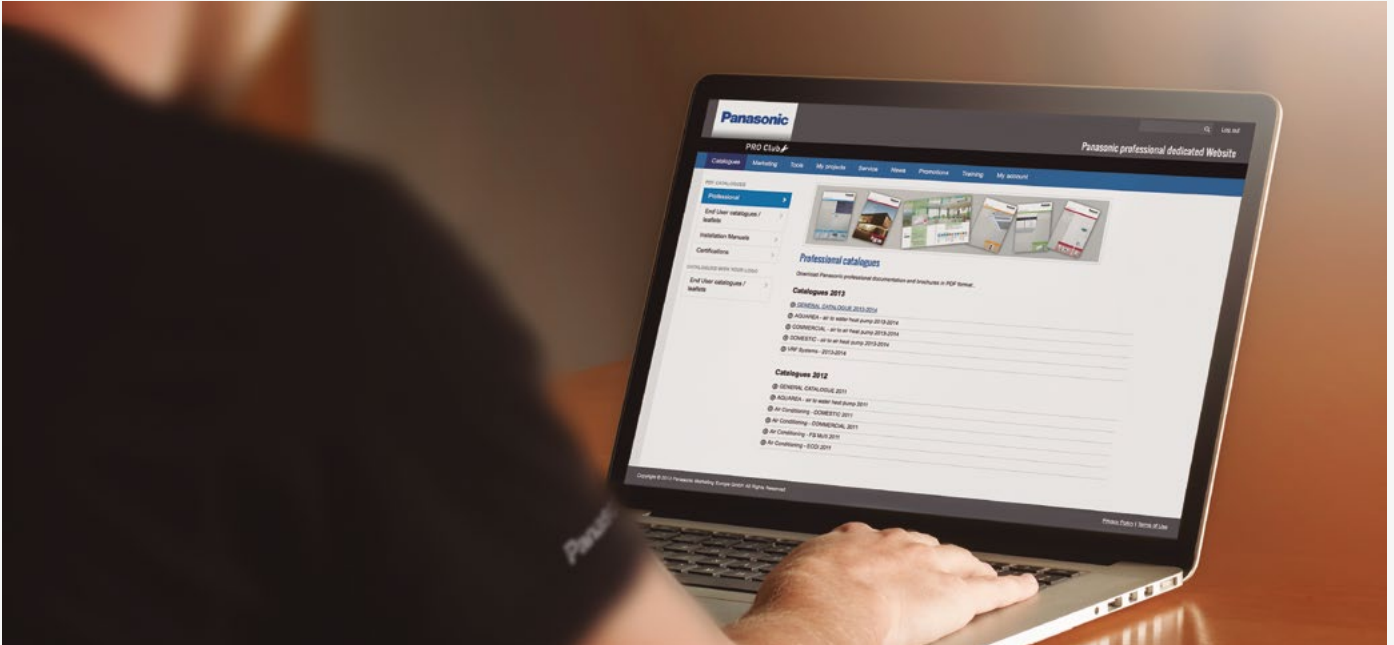

Panasonic PRO Club (www.panasonicproclub.com) is the online tool which makes your life easier! You just have to register and a lot of functionalities are freely available to you, where ever you are, from your computer or smartphone!

- Print catalogues with your logo and contact details
- Access to the extensive library of professional design, selection and calculation tools (Aquarea Designer, VRF software, chiller selector, etc.)
- Get documents of conformity and all other documents you may need
- Download all the service manuals, end user manuals and installation manuals
- Download energy labels in PDF format using the energy label generators
- Download Revit and CAD files and specification texts
- Know what to do with error codes (error code search by error code or unit ref.)
- PRO Academy: register for training
- Download product images in high resolutions, advertisements, deco guidelines
- Get to know special offers and promotions
- Find out about the latest news first

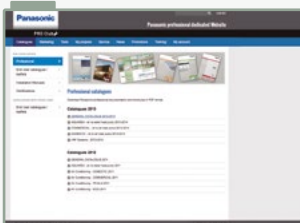

Easy download Panasonic service documentation and brochures

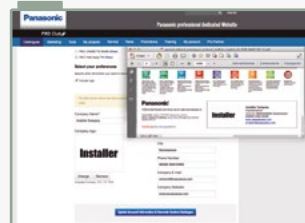

Customise leaflets with your logo and contact details. Save and print the PDF



Energy label generator. Download Energy labels of any device in PDF format

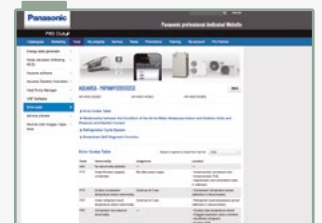

Error Code on your smartphone and your PC: Search by error code or model reference. Online version + downloadable version for offline use

Panasonic PRO Club is fully compatible with tablet computer and smartphone.

Visit www.panasonicproclub.com or connect simply with your smartphone to the PRO Club using this QR.

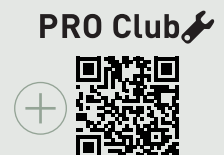

Panasonic provides bespoke software and tools helping system designers, installers and dealers to very quickly select, design and size systems or create wiring or hydraulic diagrams at the push of a button.

Aquarea Designer - online tool

With Panasonic's online tool, projects can be developed simply and easily. The newly developed tool is optimised to help HVAC professionals easily identify the most appropriate Aquarea air to water heat pump for a particular application.

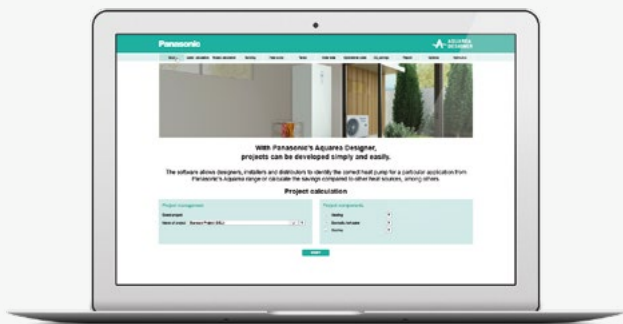

Domestic AirCon Quick Selector

This user-friendly online tool for our domestic range allows to choose the best split or multi-split system for each project needs and get the specifications of that particular application.

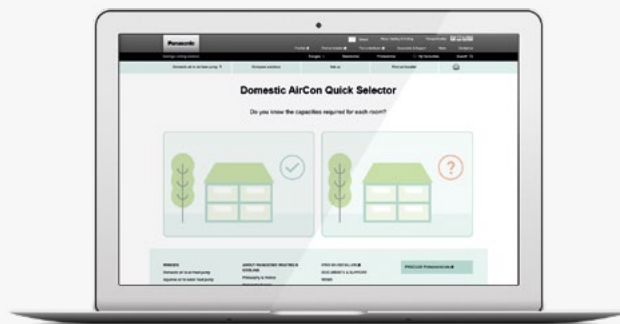

New Panasonic DX PRO Designer

The Panasonic DX PRO Designer will be rebuilt with an improved user experience. The new software runs in the cloud and is always up to date with the latest products. An intuitive interface supports the most complicated designs, allows online sharing and project collaboration with multilingual support.

* Available from Spring 2023.



Open BIM

Design, analysis and BIM modeling of Panasonic VRF and Air to Water heat pump systems. Generates documents, 3D model, schematics and drawings. This application is integrated into the Open BIM workflow via the BIMserver.center platform.

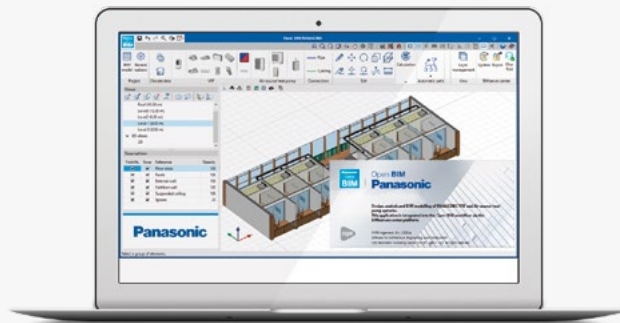

Chiller configurator

This online software solution offers a complete tool to allow the user to accurately calculate the performance at specified conditions, select and configure our range of commercial chillers, heat pumps and fan coils. It also provides a comprehensive report to share with customers and clients alike.



Refrigeration designer

This simple design tool supports engineers, installers, and technicians to make a quick calculation for commercial refrigeration systems.

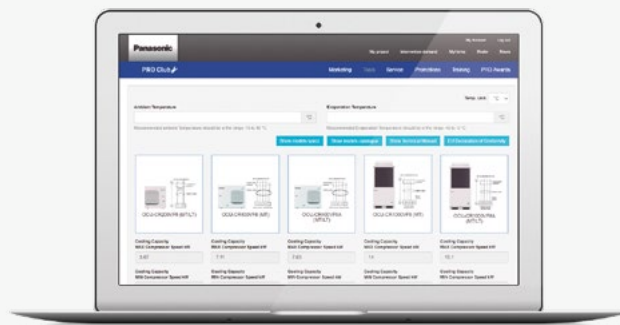

AQUAREA



Welcome to Aquarea air to water heat pumps

From 3 kW to 16 kW, Panasonic's Aquarea air to water heat pumps range is one of the widest on the market, offering solutions for most properties, whatever their size and heating and cooling demands. Suitable for new build and refurbishment projects, the solutions are cost-effective with minimised environmental impact.

Highlighted features	→ 20
Introducing the Panasonic Aquarea – air source heat pump	→ 22
Aquarea Heat Pump line-up	→ 24
New Aquarea L Generation	→ 26
New Aquarea K Generation	→ 28
Aquarea EcoFleX	→ 30
Aquarea All in One	→ 34
Aquarea High Performance	→ 36
Aquarea T-CAP	→ 38
Aquarea commercial	→ 40
Aquarea Smart and Service Cloud	→ 42
Control and connectivity	→ 44
Nearly Zero Energy Buildings (nZEB)	→ 46
Aquarea + PV Panels	→ 47
Panasonic PRO Club	→ 48
Aquarea Designer - online tool	→ 49
Aquarea Heat Pumps range	→ 50

Aquarea Hydrosplit

All in One L Generation · R290	→ 52
All in One L Generation 2 zones · R290	→ 53
All in One L Generation with Electrical Anode · R290	→ 54
Bi-bloc L Generation · R290	→ 55

Aquarea EcoFleX

Aquarea EcoFleX · R32	→ 56
-----------------------	------

Aquarea High Performance

All in One K Generation · R32	→ 57
All in One K Generation 2 zones · R32	→ 58
All in One K Generation with Electrical Anode · R32	→ 59
Bi-bloc K Generation - SDC · R32	→ 64
All in One J Generation 1 or 2 zones · R32	→ 60
All in One H Generation · R410A	→ 61

All in One Compact J Generation · R32	→ 62
All in One Compact H Generation · R410A	→ 63
Bi-bloc J Generation · R32	→ 65
Bi-bloc H Generation · R410A	→ 66
Mono-bloc J Generation · R32	→ 67
Mono-bloc H Generation · R410A	→ 68

Aquarea T-CAP

All in One K Generation · R32	→ 69
All in One K Generation with Electrical Anode · R32	→ 70
All in One K Generation · R32	→ 74
All in One H Generation · R410A	→ 71
All in One H Generation · R410A	→ 73
All in One Compact H Generation · R410A	→ 73
Bi-bloc H Generation · R410A	→ 75
Bi-bloc H Generation - SQC · R410A	→ 76
Mono-bloc J Generation · R32	→ 77

Aquarea HT

Bi-bloc F Generation · R407C	→ 78
Mono-bloc G Generation · R407C	→ 79

Fan coils highlighted features	→ 80
Smart fan coils	→ 81
Fan coils - ducted	→ 82
Fan coils - wall-mounted	→ 84
Wired controllers for AC and EC fan coils	→ 85
Sanitary tanks	→ 86
Heat recovery ventilation unit	→ 88
Counter flow ventilation	→ 90
DHW Stand Alone	→ 92
Accessories and control	→ 94
Heating and cooling capacity tables	→ 98
Examples of installations	→ 109

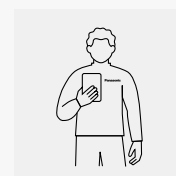
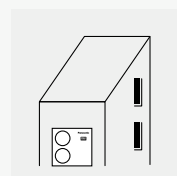
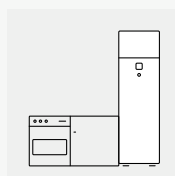
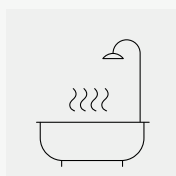
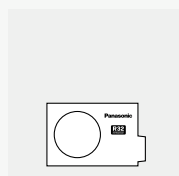

Highlighted features

Panasonic's Aquarea range of heat pumps deliver major energy savings thanks to its incredible efficiency even at -20 °C. The Panasonic Aquarea Heat Pumps are designed and produced by Panasonic and not by other companies.



The Aquarea Heat Pump is a system that generates the perfect temperature and produces hot water, in an easy, cheap and environmentally conscious way, by transferring heat instead of generating it. It is among the Technologies listed on the International Energy Agency (IEA) Blue Map, whose goal is to reduce CO₂ emissions to half the levels emitted in 2005, by the year 2050. Aquarea is part of a new generation of heating solutions that use a renewable, free energy source (the air) to heat or cool the home and to produce hot water.

Energy saving



Natural refrigerant R290 with GWP 3.

The new construction ensures a reduced noise level and increased safety for the use of R290.



Refrigerant R32.

Our heat pumps containing R32 refrigerant show a drastic reduction in the value of Global Warming Potential (GWP).



Better efficiency and value for medium temperature applications.

ErP 55°C

Energy efficiency class up to A++ in a scale from A+++ to D.



ErP 35°C

Better efficiency and Value for low temperature applications.

Energy efficiency class up to A+++ in a scale from A+++ to D.



DHW

Better efficiency and Value for domestic hot water.

Energy efficiency class up to A+ in a scale from A+ to F.



Inverter Plus.

Panasonic Inverter Plus compressors are designed to achieve outstanding level of performance.



AUTO SPEED

A class water pump.

Aquarea are built-in with A class energy efficiency water pump. High efficiency circulating the water in the heating installation.



ErP 2018.

Compliant following COMMISSION REGULATION (EU) No2016/2281.



EC motor green ventilation.

Range of fan coils with improved efficiency and optional EC fan motors.

High performance and indoor air quality



HIGH PERFORMANCE

Aquarea High Performance for low consumption houses.

From 3 to 16 kW. For a house with low temperature radiators or under-floor heating, our high performance Aquarea HP is a good solution. * COP of 5,33 for K and J Generation 3 kW.



T-CAP

Aquarea T-CAP for extremely low temperatures.

From 9 to 16 kW. If the most important aspect is to maintain nominal heating capacities even at temperatures as low as -7 °C or -20 °C, select the Aquarea T-CAP.



HIGH TEMPERATURE

Aquarea HT ideal for retrofit.

From 9 to 12 kW. For a house with traditional high-temperature radiators, the Aquarea HT solution is the most appropriate, can work in output water temperatures of 65 °C even at outdoor temperatures as low as -20 °C.



DHW

DHW.

With Aquarea you can also heat your domestic hot water at a very low cost with the optional hot water cylinder.



HEATING MODE

Down to -20 °C in heating mode.

The heat pumps work in heating mode with an outdoor temperature is as low as -20 °C.



WATER FILTER WITH MAGNET

Water filter with magnet.

Easy access and fast clip technology for J Generation onwards. Water filter only for H Generation.



FLOW TEMPERATURE

75 °C output water.

Reaches water outlet temperature up to 75 °C for L Generation.



FLOW TEMPERATURE

65 °C output water.

Reaches water outlet temperature up to 65 °C.



FLOW SENSOR

Water flow sensor.

Included on H Generation onwards.



5 YEARS COMPRESSOR WARRANTY

5 Years compressor warranty.

We guarantee the outdoor unit compressors in the entire range for five years.

High connectivity



BOILER CONNECTION

Renovation.

Our Aquarea Heat Pumps can be connected to an existing or new boiler for optimum comfort even at very low outdoor temperatures.



SOLAR KIT

Solar kit.

For even greater efficiency, our Aquarea Heat Pumps can be connected to photovoltaic solar panels with an optional kit.



ADVANCED CONTROL

Advanced control.

Remote controller with full dotted 3,5" wide back light screen. Menu with 17 available languages easy to use for installer and user. Included on H and J Generations.



INTERNET CONTROL

Internet control.

A next generation system providing user-friendly remote control of air conditioning or heat pump units from everywhere, using a simple Android™ or iOS smartphone, tablet or PC via the internet.



BMS CONNECTIVITY

BMS connectivity.

The communication port can be integrated into the indoor unit and provides easy connection to, and control of, your Panasonic heat pump to your home or Building Management System.



SG READY



Aquarea H and J Generations heat pumps in combination with the optional PCB CZ-NSP4 hold the SG Ready Label (Smart Grid Ready Label), given by Bundesverband Wärmepumpe (German Heat Pump Association). This Label shows the real capacity of Aquarea to be connected in an intelligent grid control. MCS Certificate number: MCS HP0086*. Keymark: Check all our certified heat pumps on: www.heatpumpkeymark.com. Passive House Institute: Certified models can be checked in <https://database.passivehouse.com>.

* Not all products certified. As the certification process is on-going and the list of certified products constantly changing, please check for latest details on the official websites.

Warning on quality of water and groundwater use: This product is designed to comply with the European Water Quality Directive 98/83/EC amended by 2015/1787/EU. The lifespan of the product is not guaranteed in the case of the use of groundwater, such as spring water or well water, the use of tap water when salt or other impurities are contained, nor in areas of acidic water quality. Maintenance and warranty costs related to these cases are the customer's responsibility.

Introducing the Panasonic Aquarea – air source heat pump

At the forefront of energy innovation, Aquarea is resolutely positioned as a “green” heating and air conditioning solution.



Introducing the Panasonic Aquarea – air source heat pump.

In European households, 79%* of energy consumption comes from heating and producing domestic hot water. By converting heat energy in the air into household warmth, highly efficient Aquarea technology reduces CO₂ emissions and environmental impact, compared to conventional boilers and electric heaters. Compared to an electric heater, the Aquarea Heat Pumps offer up to five times the output in kilowatts per every input in kilowatts.

* ec.europa.eu/eurostat

Comparison: 1 kW input versus output in kW.

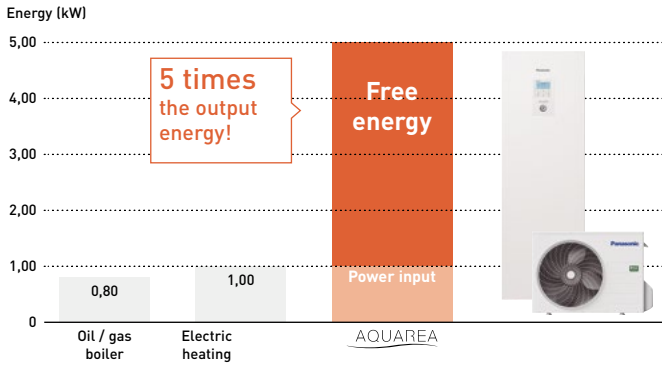

* 35 °C flow temperature.



Why Panasonic Aquarea air source heat pumps?

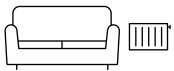

Optimum solutions for premium comfort.

Panasonic Aquarea Heat Pumps warm your home effectively and efficiently, to optimise the comfort.

- Precise control the indoor temperature thanks to reliable Panasonic Inverter Compressors
- Aquarea can cool space in summer and brings hot water all year round
- Night mode to reduce the noise when it's needed
- Aquarea T-CAP heat pumps can work in outdoor temperatures as low as -28 °C (for All in One and Bi-bloc)
- Energy savings, comfort and convenient control from any location thanks to Aquarea Smart Cloud
- Aquarea Service Cloud enables remote maintenance of the system



Energy saving means money savings.

Panasonic Aquarea Heat Pumps are a smart choice for saving in heating, all leading to large savings in electricity bills.

- Savings of up to 80% on heating expenses, compared to electrical heaters
- Up to A+++ in heating, within the range of A+++ to D, and A+ in domestic hot water, in the range of A+ to F
- Energy consumption can be further reduced by connecting photovoltaic panels to the system
- In combination with a ventilation solution, the indoor air becomes cleaner and the heating requirements of the building are reduced



Adapts to your needs.

Panasonic Aquarea Heat Pumps produce heating, cooling and domestic hot water with a single system.

- From 3 kW to 16 kW, there is always an option for lower initial investment and lower operational cost
- Aquarea can be connected to floor heating, radiators or fan coil units
- In refurbishment projects, Aquarea can be integrated in existing heating systems
- Providing water outlet temperatures of up to 75 °C down to -10 °C¹⁾
- Large piping length of up to 50 m between indoor and outdoor
- Aquarea T-CAP heat pumps guarantee the capacity without backup heating down to -20 °C²⁾

1) Aquarea L Generation. 2) At 35 °C flow temperature.



Contributing to a decarbonised society.

The heat pump is considered a 'green' choice as the heat energy is taken from the environment, making it a sustainable option.

- It maintains a comfortable indoor temperature while significantly reducing environmental burden
- All Aquarea Heat Pumps can also be connected to a solar thermal or PV system in order to increase efficiency and minimise environmental impact
- Aquarea L Generation heat pumps are engineered with natural refrigerant R290 with GWP 3

Aquarea Heat Pump line-up



EcoFlex System.

The system, consisting of separate indoor and outdoor units, connects to the heating and/or hot water system and an air ducted unit with nanoe™ X technology. The indoor unit includes a stainless steel tank (185 L).

All in One System.

The system, consisting of separate indoor and outdoor units, connects to the heating and/or hot water system. The indoor unit includes a stainless steel tank (185 L).

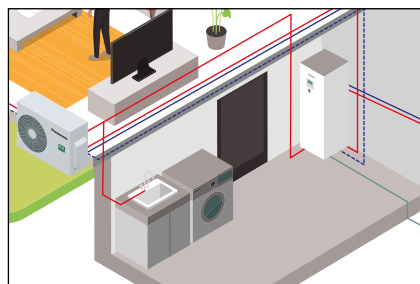

Bi-bloc System.



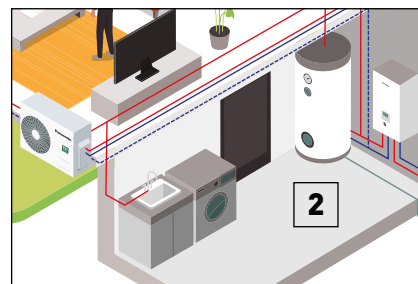

The system, consisting of separate indoor and outdoor units, connects to the heating and/or hot water system (tank not included).

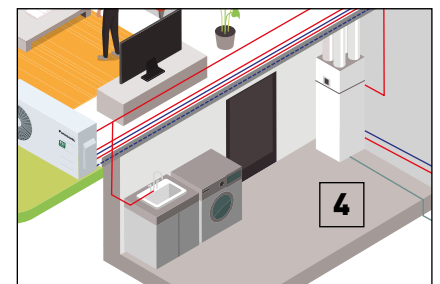

Mono-bloc System.

This only has an outdoor unit. The installation doesn't require a refrigerated connection and is only connected to the heating and/or hot water (tank not included).



<div data-bbox="103 1904 151 1948" data-label="Text"> <p>1</p> </div> 	<div data-bbox="454 1904 502 1948" data-label="Text"> <p>2</p> </div> 	<div data-bbox="813 1904 861 1948" data-label="Text"> <p>3</p> </div> 	<div data-bbox="1165 1904 1212 1948" data-label="Text"> <p>4</p> </div> 
<p>Control through smartphone, tablet or computer (optional).</p>	<p>Super high efficiency cylinder (optional).</p>	<p>Fan coils for heating and cooling (optional).</p>	<p>Heat recovery Ventilation + DHW Tank (optional).</p>

Panasonic Aquarea offers you solutions, helping to make the home more efficient and the installation cheaper and easier.

Aquarea EcoFleX

For new installations, specially those with limited spaces.

Aquarea EcoFleX is a groundbreaking heat pump that connects an air ducted unit with nanoe™ X technology providing heat recovery hot water, space heating, space cooling and cleaner air. Outstanding efficiency and energy savings with low CO₂ emissions.

Aquarea High Performance

For new installations and low consumption homes.

Outstanding efficiency and energy savings with minimised CO₂ emissions and minimum space. Improved performance with COPs up to 5,33 for K and J Generation 3 kW.

Now also available with natural refrigerant R290.

Aquarea T-CAP

For extremely low temperatures, refurbishment and innovation.











Ideal to ensure that the heating capacity is maintained even at very low temperatures. This line-up is able to maintain the heat pump output capacity until -20 °C¹⁾ outdoor temperature without the help of an electrical booster heater.

1) At 35 °C flow temperature.

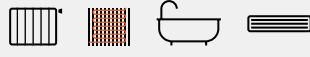
Aquarea HT

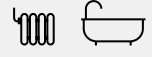
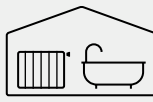
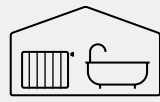
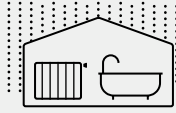
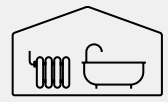
For a house with old high-temperature radiators.

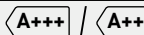
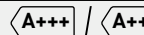
Ideal for retrofit: green energy source works with existing radiators. Aquarea HT Solution is the most appropriate, providing output water temperatures of 65 °C even at outdoor temperatures as low as -15 °C.

Aquarea EcoFleX	Aquarea High Performance		Aquarea T-CAP		Aquarea HT
 Heating - Cooling - DHW	 Heating - Cooling - DHW		 Heating - Cooling - DHW		 Heating - DHW
Connectable to					
 Radiators - Underfloor heating - DHW - Air conditioning	 Radiators - Fan coil - Underfloor heating - DHW		 Radiators - Fan coil - Underfloor heating - DHW		 Traditional high-temperature radiators - DHW
Application					
 New buildings	 New buildings and retrofit		 Extreme cold ambient and retrofit		 Retrofit for old radiators
Energy efficiency (Heating 35 °C / 55 °C¹⁾)					
 A++ / A++	 A+++ / A++		 A+++ / A++		 A++ / A++
Control and connectivity					
Smart Grid Contact ²⁾ Wi-Fi included	Smart Grid Contact ²⁾ Wireless LAN Ready (included in L generation)		Smart Grid Contact ²⁾ Wireless LAN Ready		—

	Aquarea EcoFleX	Aquarea High Performance				Aquarea T-CAP			Aquarea HT
	J	L	K	J	H	K	J	H	F/G
Minimum outdoor temperature	-15 °C	-25 °C	-25 °C	-20 °C	-20 °C	-28 °C	-20 °C ³⁾	-28 °C	-20 °C
Maximum supply temperature for heating	55 °C	75 °C ⁴⁾	60 °C	60 °C	55 °C ⁵⁾	65 °C ⁶⁾	65 °C ⁶⁾	60 °C ⁵⁾	65 °C
Refrigerant	R32	R290	R32	R32	R410A	R32	R32	R410A	R407C
Type	Split + Duct	Hydrosplit	Split	Split or Mono-bloc	Split or Mono-bloc	Split	Mono-bloc	Split	Split or Mono-bloc
Single phase capacities	8 kW	5, 7, 9 kW	3, 5, 7, 9 kW	3, 5, 7, 9 kW	12, 16 kW	9, 12 kW	9, 12 kW	9, 12 kW	9, 12 kW
Three phase capacities	—	—	—	—	9, 12, 16 kW	9, 12 kW	9, 12, 16 kW	9, 12, 16 kW	9, 12 kW

All data in this chart is applicable in most of models in each line up, check product specs to confirm. 1) Scale from A+++ to D. 2) H and J Generations with CZ-NS4P. K and L Generations with CZ-NS5P. 3) 9, 12 and 16 kW. 4) DHW maximum temperature with heater. 5) In case of outdoor temperature over -10 °C. 6) It is possible to set temperature by 65 °C on remote controller. Normally, outlet water temperature is 60 °C or lower. In case of ΔT setting with remote controller is 15 °C and the outdoor ambient temperature is 5 to 20 °C, outlet water temperature 65 °C is possible.

New Aquarea L Generation

A revolution in design, efficiency, connectivity and sustainability. Aquarea L Generation is engineered with industry leading R290 natural refrigerant. It is the perfect solution for renovations, where a high water outlet temperature is required or homes looking for avant-garde heat pump with natural refrigerant.



Natural refrigerant GWP3. Save CO₂.

A next generation environment friendly heat pump that uses a low GWP refrigerant as a product that represents the Panasonic environmental concept of GREEN IMPACT.



Natural refrigerant

Employ natural refrigerant R290 with GWP 3.

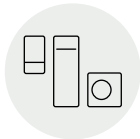

Improved clean design

Refined outdoor design to be blended to the environment.



Remote control and maintenance

Aquarea Smart Cloud. Aquarea Service Cloud.

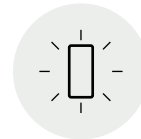

High tank insulation performance

Tank boasts high heat retention thanks to U-Vacua™¹⁾.



High energy efficiency for retrofit projects

A++ energy class at 55 °C water outlet temperature.

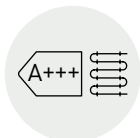

High energy efficiency for new buildings

Top class ErP for heating at 35 °C water outlet temperature²⁾.



High energy efficiency for domestic hot water

DHW COP up to 3,6²⁾.

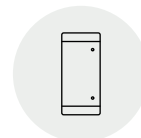

Further energy savings

Domestic hot water up to 65 °C without heater for tank sterilization.



Further flexibility.

- Hydraulic connection between Indoor and outdoor
- Less frequent maintenance with pre-installed magnet filter
- Operation without backup heating at -25 °C³⁾
- Water outlet temperature maximum 75 °C at -10 °C outside temperature
- Can supply 55 °C hot water even at -25 °C outside temperature³⁾
- Bluefin treatment protection on outdoor heat exchanger for harsh ambient conditions

1) U-Vacua™ is a vacuum insulation panel (VIP) technology. 2) Scale from A+++ to D. Might not apply to all the models. 3) Tentative feature.

The outdoor unit is designed to harmonize with architecture and the environment

Panasonic's unique low noise architecture.

The compressor, which is a major source of noise, is equipped with a double-bottomed structure to provide a safe, quiet structure that does not disturb neighbors in crowded residential areas.

Aquarea L Generation safety optimisation.

- 1 | Non-flammable control box
- 2 | Power box cable ground with sealed connections
- 3 | Air refrigerant separator

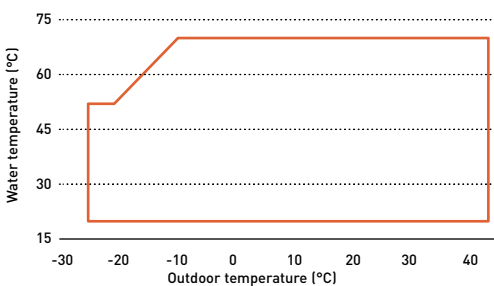
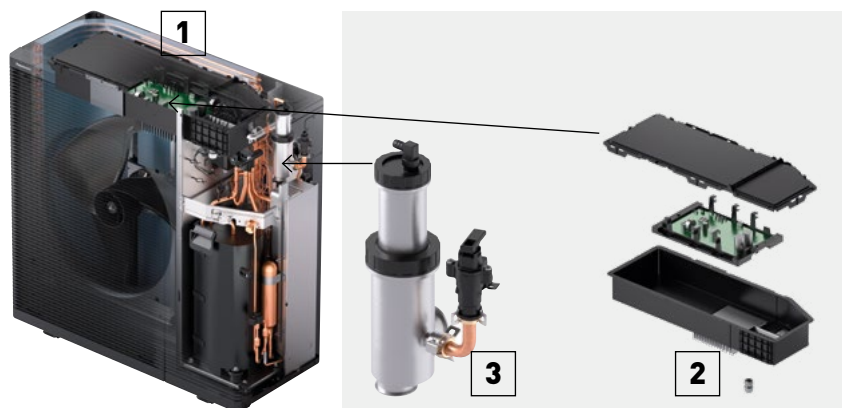

High performance under extreme conditions

Aquarea L Generation compressor operates without backup heating down to -25 °C ambient temperatures*, providing water outlet temperatures of up to 75 °C down to -10 °C. Even at -25 °C outside temperature, Aquarea L Generation heat pumps can supply hot water at 55 °C*.

* Tentative feature.

New Aquarea K Generation

A revolution in design, efficiency, connectivity and sustainability. Aquarea K Generation is a ground breaking low-energy system for heating, cooling and domestic hot water production that delivers outstanding performance. This model is ideal for new installations and well-insulated homes.



Harmony between technology and home.

In our daily lives, technology is attuned to you and the environment around you, without overstating the device or interface. Just as the air is always around you even if you're not aware of it, Panasonic's technology continues to be in tune with your environment and your life.



Wide range

Wide range to suit all homes: High Performance and T-CAP.

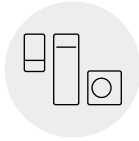

Improved clean design

Refined outdoor design to be blended to the environment.



Optional remote control and maintenance

Aquarea Smart Cloud.
Aquarea Service Cloud.

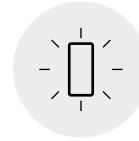

High tank insulation performance

Tank boasts high heat retention thanks to U-Vacua™¹⁾.

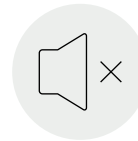

Further noise reduction

Panasonic's unique low noise architecture.



High energy efficiency for heating

High energy class for low and medium temperature applications.

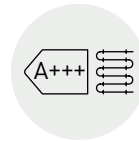

High energy efficiency for heating

High energy class for low and medium temperature applications.



High energy efficiency for domestic hot water

DHW COP up to 3,5²⁾.



Further flexibility.

- Less frequent maintenance with pre-installed magnet filter
- Easy access to hydraulic parts
- Operation without backup heating at -25 °C³⁾
- Can supply 60 °C hot water even at -10 °C outside temperature
- Bluefin treatment protection on outdoor heat exchanger for harsh ambient conditions

1) U-Vacua™ is a vacuum insulation panel (VIP) technology. 2) Scale from A+++ to D. Might not apply to all the models. 3) Tentative feature.

All in One unit and Bi-bloc indoor unit are designed to blend into your interior space effortlessly

Like indoor equipment, the outdoor unit is designed to harmonize with architecture and the environment while quietly supporting the precious time spent with the warm family.

The optional WLAN adapter CZ-TAW1B, can be simply connected through our new front panel, offering flexible and intuitive connectivity.

The outdoor unit is designed to harmonize with architecture and the environment

The outdoor units, with an anthracite grey colour which will dress the entire range, have been completely redesigned with an innovative design that will find its place in all spaces.

Panasonic's unique low noise architecture.

The compressor, which is a major source of noise, is equipped with a double-bottomed structure to provide a safe, quiet structure that does not disturb neighbours in crowded residential areas.



-8 dB(A) in quiet mode

Aquarea EcoFlex

2-in-1 - Sustainable and efficient comfort all year long.

Aquarea EcoFlex is a groundbreaking heat pump that connects an air ducted unit with nanoe™ X technology providing heat recovery hot water, space heating, space cooling and cleaner air. Outstanding efficiency and energy savings with low CO₂ emissions.

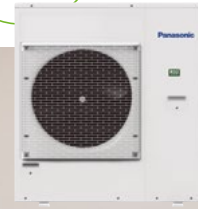

1 Multi solution

- Trendy air to water + DX value added solution, featuring bi-heating and heat recovery function.
- Bi-heating: Simultaneous air heating and DHW or heating
 - Heat recovery: Re-use wasted heat from the outdoor unit for DHW production
 - Non-stop heating: Air heating runs continuously even in defrost operation

2 Compact design

Aquarea EcoFlex offers outstanding design and efficiency, ideal for installations with limited spaces such as apartments or housing complexes. The compact outdoor unit can supply both air conditioning and hot water at the same time. The Tank fits beautifully in any kitchen, small laundry space, or any other desired area. No need for gas supply.

3 Smart convenience

Energy savings, comfort and control from anywhere. Aquarea EcoFlex is equipped standard with Wi-Fi to enable smart control and energy consumption monitoring, using Aquarea Smart Cloud.

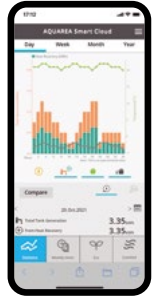

4 nanoe™ X technology to improve protection 24/7

This advanced technology utilises hydroxyl radicals (also known as OH radicals), which inhibit the growth of certain pollutants such as allergens, bacteria, viruses, moulds, odours, and certain hazardous substances. This naturally occurring process has major benefits indoors and improves the protection inside a room 24/7.

The nanoe™ X performance varies depending on the room size, environment and usage and it may take several hours to reach the full effect (see page 10 for more detail). nanoe™ X is not medical device, local regulations on building design and sanitary recommendations must be followed.



Unique technology that drives the system

Heat recovery.

Cooling (air to air) + DHW (air to water).

Heat exchange that took place in outdoor unit now is carried out in the water heater.

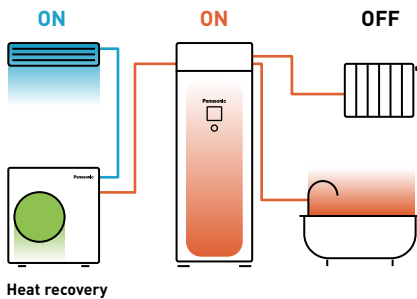

Bi-heating.

Heating (air to air) + Heating (air to water) or DHW.

Heat from the compressor is supplied for heating and DHW simultaneously.

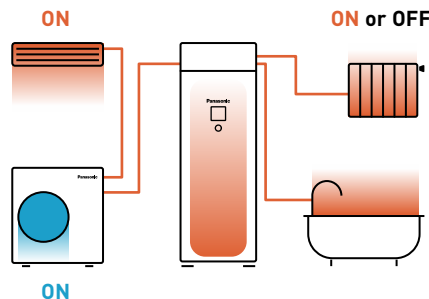

Non-stop heating.

Heating (air to air) continuous operation.

Use heat from tank to defrost and heat simultaneously.

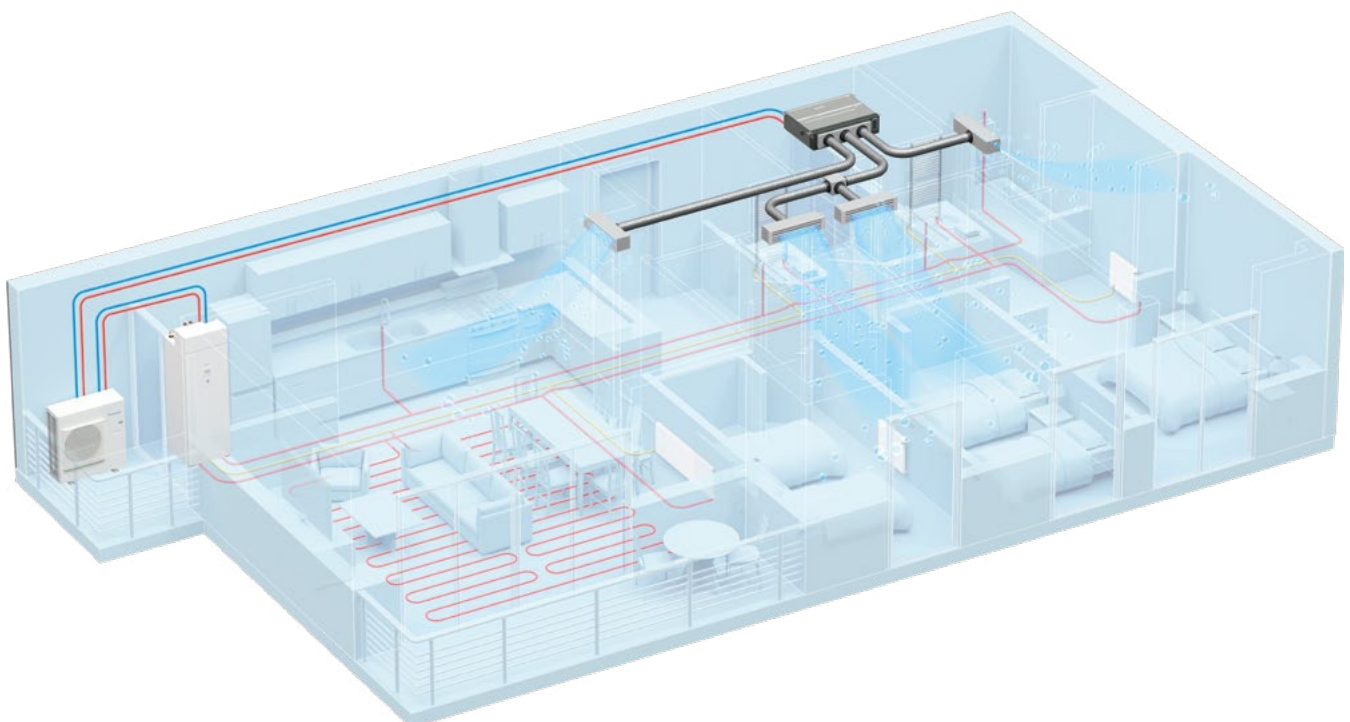
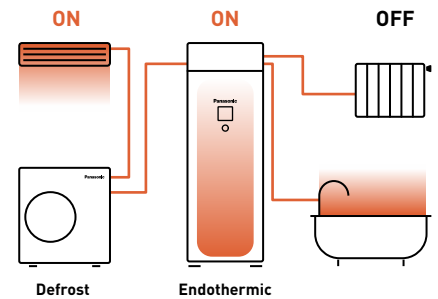

Aquarea EcoFlex.

Air to water

Tank unit + heat exchanger box to produce domestic hot water and space heating using radiators or floor heating.

Fits beautifully in any kitchen, small laundry space, or any other desired area

Kitchen.



Laundry space.



The same depth as a regular refrigerator/washing machine.

Deep: 600 mm
Wide: 598 mm

Deep: 600 mm
Wide: 600 mm

Deep: 600 mm
Wide: 600 mm

Compact, yet easy to maintain



- Heat exchanger box structure to mitigate R32 refrigerant restrictions, flexible installation.**
Water heat exchanger is designed above the top plate to comply with installation area regulation for products using large amounts of R32 refrigerant.



- Maintained serviceability.**
 - Easy maintenance concept
 - Access to hydraulic parts thanks to door opening mechanism
 - No buffer tank required, reducing space, cost and installation time

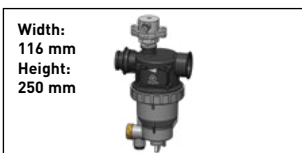

- Improved water filter for less maintenance.**
Superior dust removal capacity of the water filter. Less frequent filter cleaning means more convenience.



- Slim indoor unit with big tank capacity.**
Built-in 185 L water tank in a slim W 598 x D 600 mm indoor unit housing.

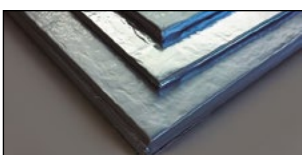

- U-Vacua insulation technology.**
Panasonic U-Vacua™ is a high performance vacuum insulation panel with very low thermal conductivity, that performs about 19 times better than standard urethane foam.

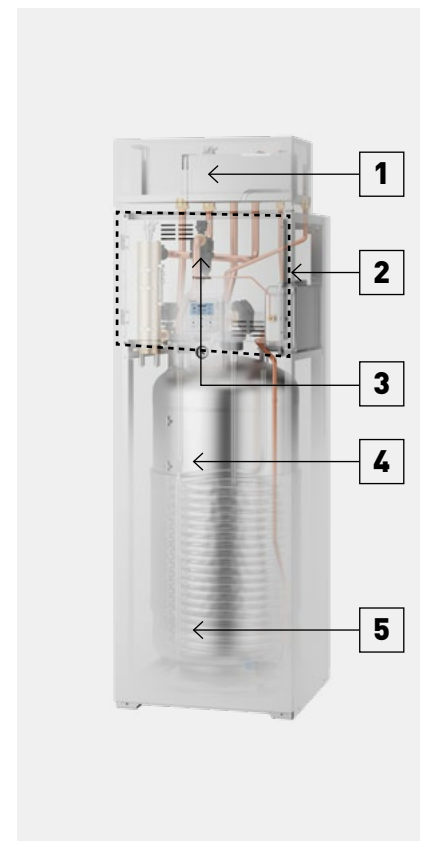

Aquarea EcoFleX. Air heating or cooling and cleaner air



Aquarea EcoFleX ducted unit has been designed to provide better comfort and flexibility.

[+ SEE PRODUCT SPECIFICATIONS](#)

1 Superior air quality

Standard equipped with nanoe™ X, a unique technology that cleans indoor air.

2 Ideal for living spaces

- Static pressure level: 10 - 150 Pa
- Compact body: Only 250 mm high
- Smart control ready via CONEX
- Rated up to SEER / SCOP class A+/A
- Low noise operation (34 dB(A)) using an improved fan casing
- DC fan motor, built-in drain pump

Panasonic's nanoe™ X technology takes this a step further and brings nature's detergent – hydroxyl radicals – indoors to help create an ideal environment



Thanks to the nanoe™ X properties, several types of pollutants can be inhibited such as certain types of bacteria, viruses, mould, allergens, pollen and certain hazardous substances.

Deodorises

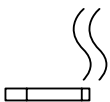

Odours

Capacity to inhibit 5 types of pollutants

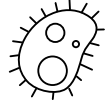

Bacteria and viruses



Mould



Allergens



Pollen



Hazardous substances



Skin and hair

Moisturises

The nanoe™ X performance varies depending on the room size, environment and usage and it may take several hours to reach the full effect. nanoe™ X is not medical device, local regulations on building design and sanitary recommendations must be followed.

[+ REFER TO PAGE 10 FOR MORE DETAILS AND VALIDATION DATA](#)

nanoe™ X: improving protection 24/7



Acts to clean your air, so that the indoor environment can be a cleaner and more pleasant place to be all day long. nanoe™ X works together with heating or cooling function when you are at home and can work independently when you are away. Give the air conditioning the strength to increase the protection at home with nanoe™ X technology and convenient control via the Panasonic Comfort Cloud App.



Cleans the air when you are away.

Leave the nanoe™ mode ON to inhibit certain pollutants and deodorise before you return home.

Improves your environment when you are at home.

Enjoy a cleaner, comfortable space with loved ones.

Selectable inlet air position

Inlet air position may be adjusted by means of a removable panel, to allow rear or bottom entry, depending on the duct installation.

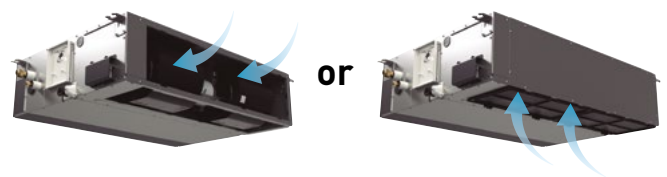

Compact body

- Only 250 mm high
- Light units from 25 to 39 kg

Conventional model	33 kg	290 mm
Ducted unit	30 kg	250 mm

Ducted unit



Aquarea All in One

The Aquarea All in One unit is the ultimate space-saving solution. Its 599 x 602 mm footprint, standard size of other big appliances, reduces the space required for the installation.



Aquarea All in One: the best Panasonic technology for your home.

High quality components inside:

- Maintenance free Inox stainless 185 l tank
- Variable speed water pump (class A)
- Less frequent maintenance with pre-installed improved magnet filter
- Expansion vessel
- Vortex flow sensor
- Back up heater
- Safety valve
- Air purge valves
- 3 way valve inside

The ultimate space-saving solution.

- 599 x 602 mm footprint reduces required installation space
- Low height leaves space for a ventilation unit
- No buffer tank required, reducing space, cost and installation time

Aquarea All in One Compact: Made compact but maintenance is still easy



Great serviceability.

- Easy maintenance concept is retained
- Easy access to hydraulic part thanks to door opening mechanism
- No buffer tank required, reducing space, cost and installation time
- All sensors can be checked from the remote controller (new)
- Water pressure sensor (new)

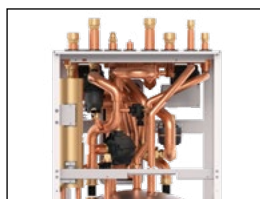

Slimmer, yet same tank capacity.

Piping layout at the top in order to maintain large 185 L tank capacity.



Improved water filter for less maintenance.

Dust removal capacity of the water filter has been increased 5 times. Less frequent filter cleaning means more convenience.

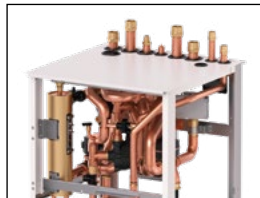

Robust body for top ventilation unit.

Strengthening the body and top surface with a frame enables installation of a top ventilation unit. For safety, it's secured with bolts to prevent it falling.



U-Vacua™; Vacuum insulation panel. Significant energy savings with world-leading insulation performance.

Because they leverage VIP technology, U-Vacua™ panels offer 19 times the insulation performance of polystyrene foam. Since the system retains heat longer, it needs to heat up fewer times each day, resulting in energy savings.

U-Vacua™ VIPs consist of a unique fiberglass core encased in a laminate film made up of several layers that include nylon, aluminium, and a protective layer. Interior pressure is reduced to a vacuum of 1-20 Pa, thereby minimising thermal conductivity.

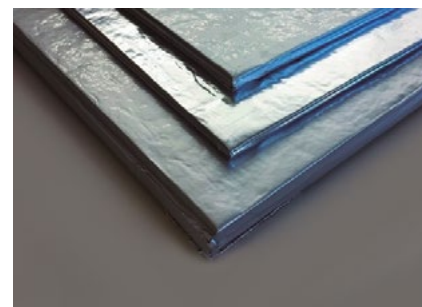

Aquarea All in One with 2 zone control: The optimal solution for an installation with 2 heating zones.

- 2 heating circuits, with 2 different water temperatures
- 2 water pumps and 2 water filters
- Floor heating water control with mixing valve

Aquarea All in One with Electrical Anode:

The All in One with built-in impressed current anode is the ideal solution for installations in locations with harsh water conditions.

Aquarea High Performance

For new installations and low consumption homes. Outstanding efficiency and energy savings with minimised CO₂ emissions and minimum space.



High Performance helps you to meet strict building requirements and reduce building costs.

The heating and production of domestic hot water have a very important impact on the energy consumption of a house. Efficient Panasonic heat pumps can help to significantly reduce the energy consumption of the house.

Key points of the line-up

- Improved performance with COPs up to 5,33 for K and J Generations 3 kW
- Reduced energy consumption through our circulating pump with energy efficiency class "A"
- Remote controller functions added: Auto mode, holiday mode, power consumption display

Panasonic has designed the Aquarea All in One, Bi-bloc and Mono-bloc heat pumps for homes which have high performance requirements. Whatever the weather, Aquarea can work even at -20 °C! The Aquarea is easy to install on new or existing installations, in all types of properties.

High Performance Heat Pumps are highly efficient (KIT-ADC03JE5 for example)

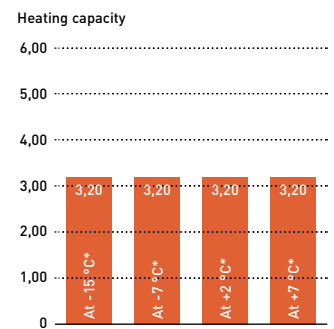
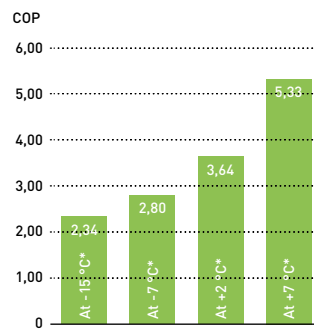

* Heating water at 35 °C.

Standard circulating pumps vs our circulating pump with energy efficiency class "A"

Comparison of energy consumption of circulation pumps. Circulating pump with energy efficiency class "A" with Dynamic flow control for 5 kW Mono-bloc.

* Based on German market: Assuming Standard pump may vary depending on consumption and energy cost.

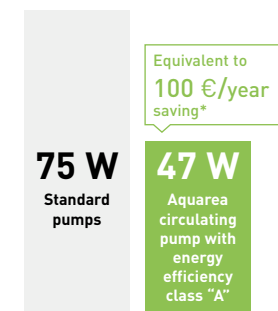

Panasonic created a night mode to reduce the noise when it's needed

Special attention has been given to noise levels.

- 1) Sound pressure measured at 1 m from the outdoor unit and at 1,5 m height.
- 2) At standard condition working at heating capacity at +7 °C (heating water at 35 °C) for two fans outdoor units. For one fan outdoor units, night mode reduction is 3 dB(A).

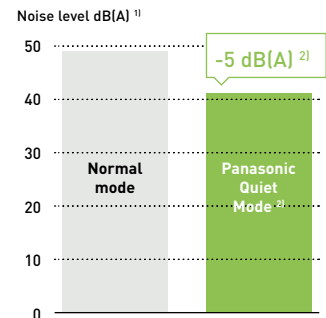

High Performance J Generation keeps 60 °C water outlet temperature even at very low temperatures

Aquarea High performance J Generation is able to keep 60 °C water outlet temperature in outdoor temperatures down to -10 °C, keeping high comfort in the room even at low temperatures. With other heat pumps, water temperature dramatically drops at low outdoor temperatures, making the heat pump to work out of the design conditions and creating discomfort inside the room.

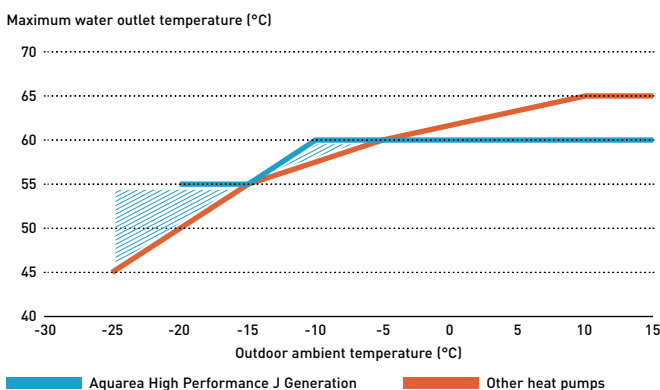

Aquarea T-CAP

For retrofit and new builds, Aquarea T-CAP is the ideal solution for those installations where the output capacity is demanding. The entire Aquarea T-CAP line-up is excellent for replacing gas or oil boilers and for connecting to new underfloor heating, radiators or fan coil units. Aquarea T-CAP can maintain the heat pump output capacity until $-20\text{ }^{\circ}\text{C}$ ¹⁾ outdoor temperature without the help of an electrical booster heater, offering high heating capacity even at low ambient temperatures.

¹⁾ At $35\text{ }^{\circ}\text{C}$ flow temperature.



Aquarea T-CAP Mono-bloc J Generation R32.

R32 Refrigerant: A 'small' change that changes everything.

With Mono-bloc, the refrigerant circuit is sealed inside the outdoor unit, so there is no need to worry about the amount of refrigerant per room.

65 °C¹⁾ water temperature possible.

By optimising the system and the refrigerant cycle, the unit can work under higher pressure and realise a water temperature of 65°C.

1) In case of ΔT setting with remote controller is 15 °C and outdoor ambient temperature is 5 to 20 °C, 65 °C hot water temperature is possible. Even with the T-CAP series, capacity will drop when water temperature reaches 65 °C.



How Aquarea T-CAP maintains performance even at -20 °C outdoors

A patent has been obtained for technology that can maintain heating capacity even in low outdoor temperatures through optimal control that comes from incorporating dual-piped heat exchanger into the refrigeration cycle.

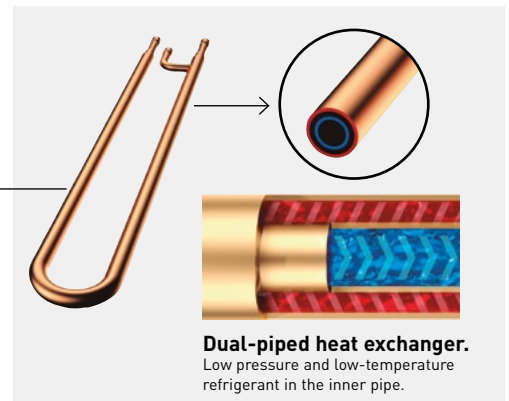

Higher efficiency compared to other heating systems

Panasonic heat pumps have a maximum COP of 5,08 at +7 °C which makes them much more efficient than others heating systems.

T-CAP is also able to provide extremely high efficiencies, whatever the outside or the water temperature.

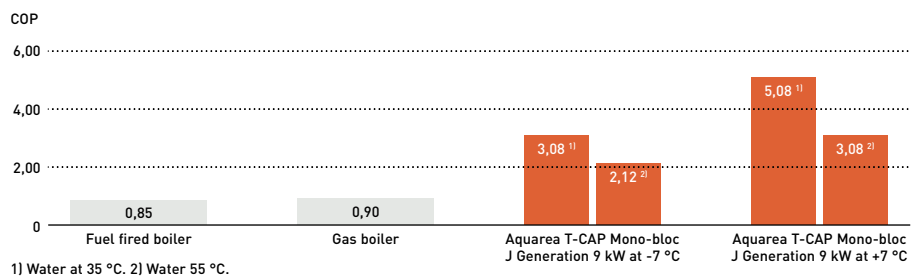

No need to oversize to reach required capacity at low temperatures

With Aquarea T-CAP technology, Panasonic heat pumps can work in outdoor temperatures as low as -20 °C and maintain capacity without backup heating at -20 °C¹⁾. With other heat pumps, a larger capacity is required to achieve the same level of comfort at low temperatures.

1) 35 °C flow temperature.

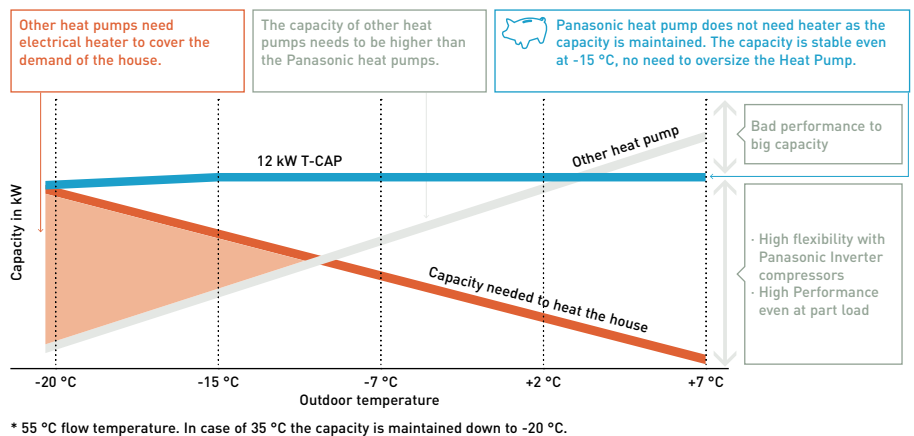

Aquarea Super Quiet T-CAP Bi-bloc

The special outdoor chassis notably reduces operation sound by up to 15 dB.^{1) 2)}

1) When comparing WH-UQ12HE8 at quiet mode level 3 operation with WH-UX12HE8 at full load operation. 2) Heating capacity may drop.

Aquarea commercial

Solutions for best savings. Efficient Panasonic heat pumps can help to significantly reduce the energy consumption of your business.

Restaurant with Aquarea.

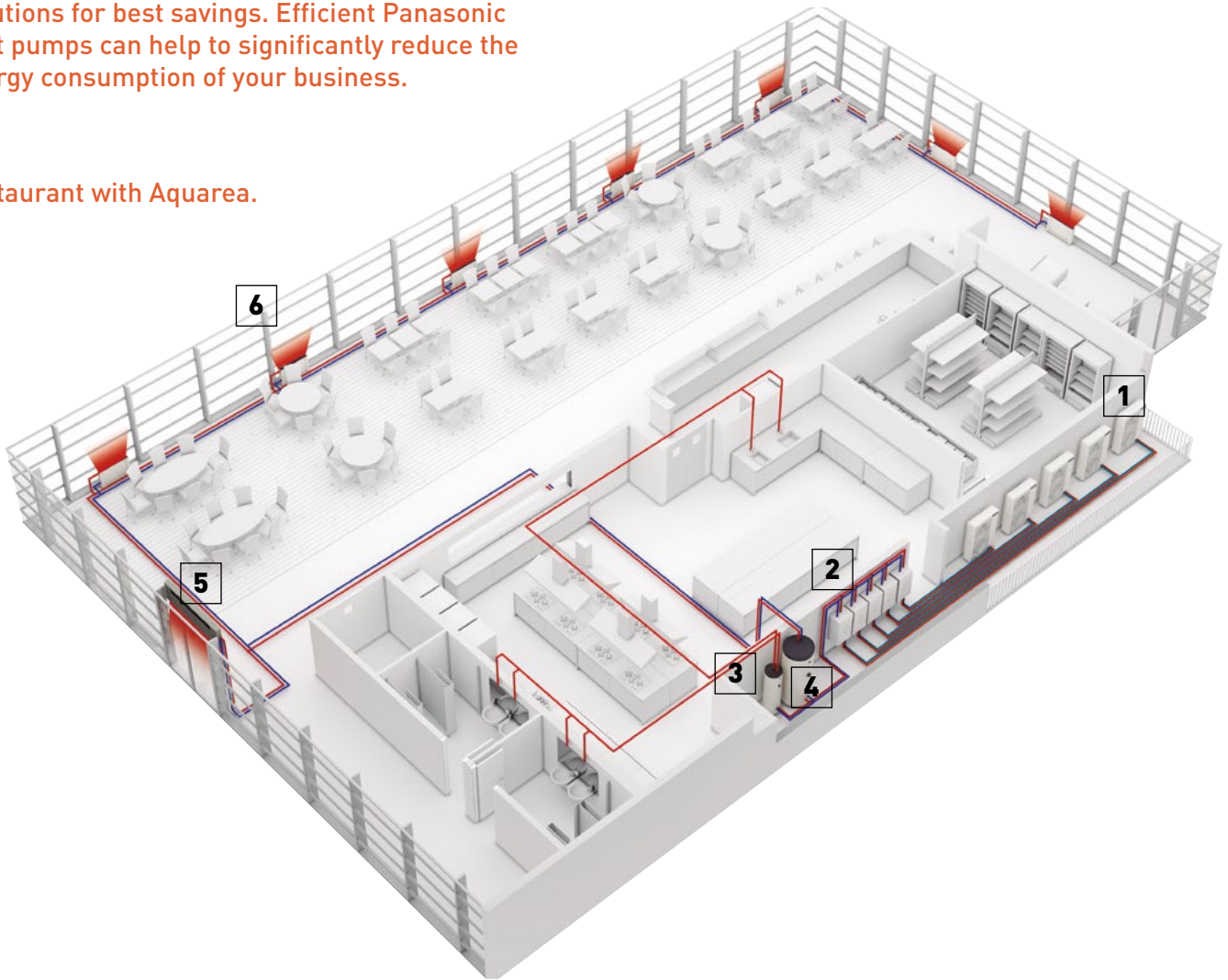

Aquarea T-CAP.
16 kW heat pumps on cascade mode. T-CAP line-up is an ideal replacement for old gas/oil boilers.

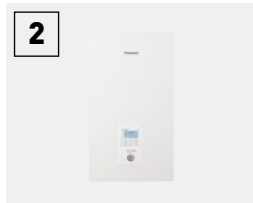

High efficiency Aquarea T-CAP hydromodule.
Indoor unit of Aquarea Bi-bloc systems. When a Mono-bloc system is used, the hydromodule is integrated in the outdoor unit.



Super high efficiency Tanks.
Combining Panasonic Aquarea with a high efficiency tank ensures the desired volume of hot water, at the correct temperature while reduced energy costs.

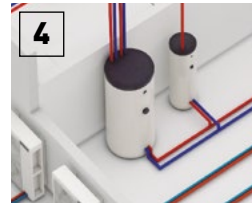

Buffer Tank.
Panasonic Aquarea can be combined with the hydraulic elements of the new or existing water system.



Air Curtain with water Coil.
Water coil air curtains can be used in the hydraulic system to have efficient performance of the water system.

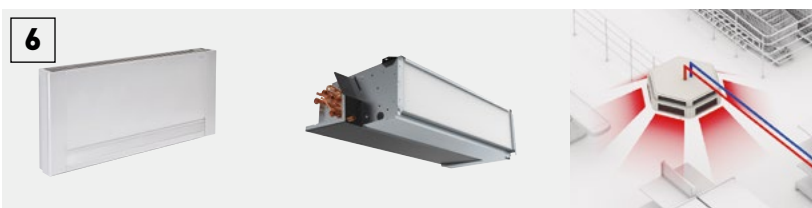

Fan coils for heating and cooling.
Aquarea Heat Pumps can be easily connected to the existing water system: 2 way and 4 way fan coils, floor heating, DHW tanks...



Cascade manager.
The cascade manager enables the control of up to 10 Aquarea Heat Pumps (balancing the working hours and making the operation more efficient) and up to 2 buffer tanks.

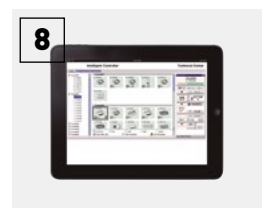

BMS integration.
The cascade system can be easily integrated in a Modbus project thanks to the cascade manager.

Panasonic Aquarea Heat Pumps offer space saving, energy-efficient heating and can be easily adapted for installation in flats, houses and commercial premises. Businesses producing heating, cooling and big quantities of hot water at 65 °C, such as restaurants or supermarkets, installing an Aquarea Heat Pump system can also use this wasted heat to improve energy efficiency further. Heat pump technology is scalable, meaning that it can be installed in buildings of varying sizes, offering both small and large-scale heating solutions. The technology is also environmentally friendly when compared to traditional

heating systems alternatives based on fossil fuel energy and in addition it is more energy efficient.

Key points:

- Efficient hot water production
- Fast return of investment
- Easy control
- Easy integration in the existing water system: fan coils, floor heating, domestic hot water tanks, etc
- Very good part load management
- High efficiency

Supermarket with Aquarea.

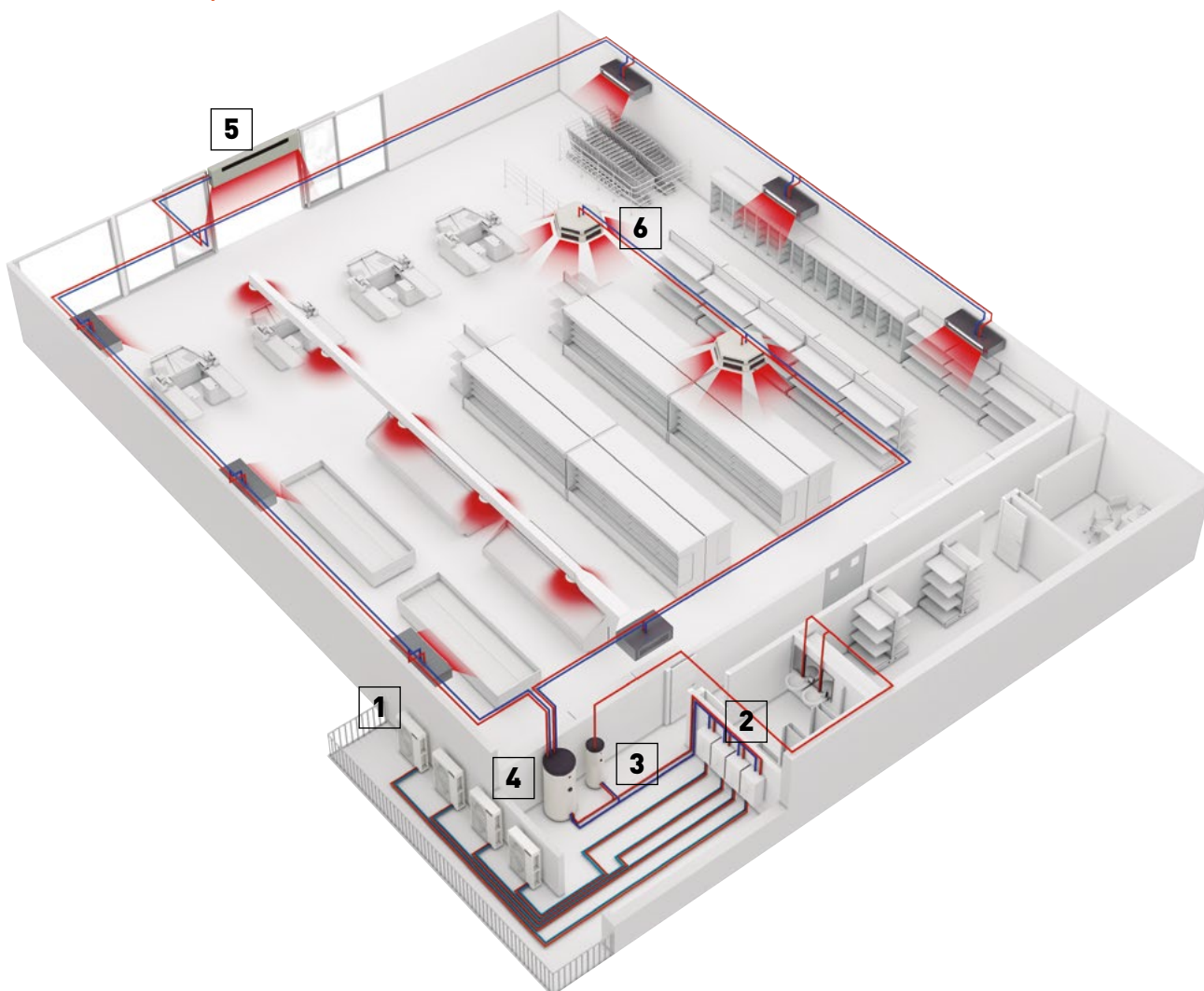

Burger & Lobster restaurant. Bath, UK.

Panasonic's air to water Aquarea system has been installed in the latest glamorous Burger & Lobster restaurant in Bath. The Octagon Chapel, a large listed building in the city centre, was converted to accommodate the restaurant, and Panasonic's Aquarea system provided an extensive, energy efficient and unobtrusive heating and cooling solution.



Carluccio's restaurant. UK.

One of UK's leading Italian restaurant, Carluccio's, wanted to install a system which would provide the desired volume of hot water, at the correct temperature while at the same time reduced energy costs. FWP installed a 12 kW Aquarea T-CAP mono bloc unit which would allow for the free air from the kitchen roof space to be transferred through condensing unit providing hot water at the optimum temperature.

Aquarea Smart Cloud for the users

The most advanced heating control for today and for the future. Aquarea can be connected to the Cloud with the accessory CZ-TAW1B, enabling both user control and remote maintenance by service partners.

WATCH DEMO



* User interface image may change without notification.

Easy and powerful energy management

The Aquarea Smart Cloud is much more than a simple thermostat for switching a heating device ON or OFF. It is a powerful and intuitive service for remotely controlling the full range of heating and hot water functions, including monitoring energy consumption.

How does it work?

After connecting an Aquarea J or H generation to the cloud by wireless LAN or by wired LAN, the user accesses the Cloud portal to remotely operate all functions of his units. He can also permit service partners to access customised functions for remote maintenance and monitoring.

Requirements

1. Aquarea J or H Generation
2. In-house internet connection with router wireless LAN or wired LAN
3. Get a Panasonic ID in <https://aquarea-smart.panasonic.com/>

Functions:

- Visualization and Control
- Scheduling
- Energy Statistics
- Malfunction notification



More possibilities with IFTTT.

IF This Then That: IFTTT service enables user to automatically trigger actions for Aquarea system based on other apps, web services or devices.

Connect your Aquarea to your voice assistant, get an e-mail if your Aquarea gets an error or automatically turn on your Aquarea on Heat Mode when outdoor temperature drops below specified level.

Advantages

Energy savings, comfort and control from anywhere. Increased efficiency and resources management, operating costs savings and owner satisfaction. The Aquarea Smart Cloud services are focused on enabling full remote maintenance of the Aquarea system. This allows maintenance specialists to engage in predictive maintenance and system fine-tuning, as well as fixing malfunctions when they occur.

Aquarea compatibility	H and J Generations
Connection point	CN-CNT Aquarea port
Home router connection	Wireless or Wired LAN
Temperature sensor	Can use remote controller sensor
Tablet or PC browser compatibility*	Yes
Operation from remote — ON / OFF — Temperature setting Mode selection — DHW setting — Error codes — Scheduling	Yes
Heating areas	Up to 2 zones
Power consumption estimation — Operation log history	Yes — Yes

* Check browsers and version compatibility.

Get the most out of your Aquarea Heat Pump.

Aquarea+ offers end user useful information to operate a Panasonic Aquarea Heat Pump to provide heating, cooling and hot water in the most efficient and cost effective way.



AQUAREA+

Aquarea Service Cloud for installers or maintenance companies

WATCH DEMO



The Aquarea Service Cloud allows installers to take care of their customers' heating systems remotely. It saves time and money and shortens the response time, thus increasing the customers' satisfaction.



The real remote maintenance made simple

Advanced functions for remote maintenance with professional screens:

- Global view at a glance
- Error log history
- Full unit information
- Statistics always available
- Most settings available

Home page.

Status of connected users at a glance. 2 view options: map view or list view.

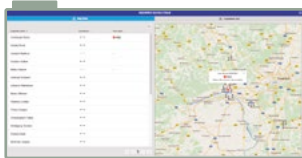

Status tab.

Current status of unit with a maximum 28 parameters.



Statistics tab.

Customisable statistics of a maximum of 71 parameters. Available anytime with the information of the last 7 days.

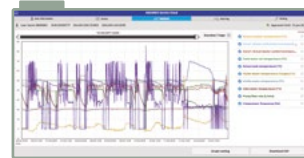

Settings tab.

Most of the user and installer settings can be done remotely.



Activation of the Aquarea Service Cloud

Requirements.

Hardware and connection	End user registration	Installer / maintenance registration
J or H Generation Aquarea connected to CZ-TAW1B	Get Panasonic ID	Get Service ID
In-house internet connection with Wireless LAN or Wired LAN	Aquarea Smart Cloud	Aquarea Service Cloud

Connecting the unit to the Aquarea Service Cloud.

The process can be initiated by the end user or by the installer. The end user can select and change the installer's level of control anytime (4 levels).

Installer registration: <https://aquarea-service.panasonic.com/>

End user registration: <https://aquarea-smart.panasonic.com/>

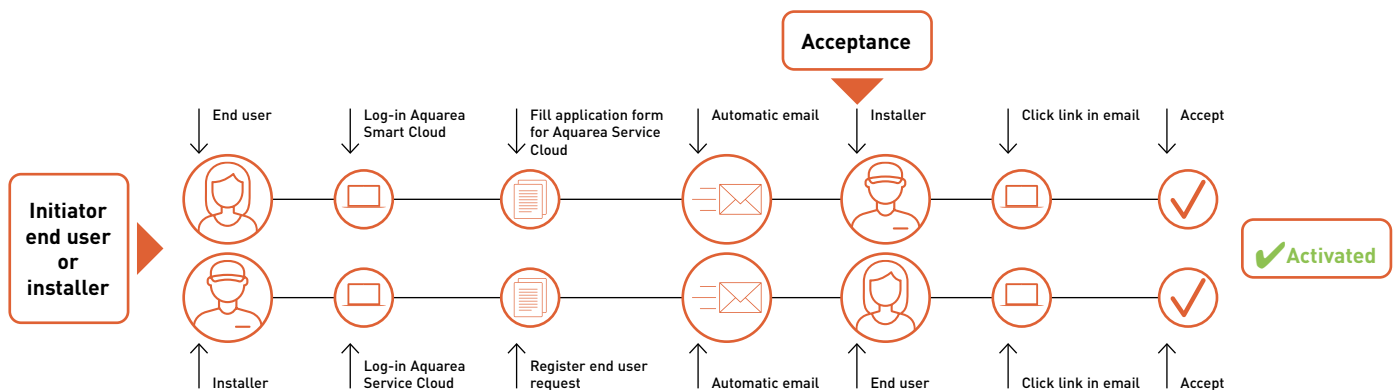

Control and connectivity

Home connectivity and Home Managements Systems integration is becoming more and more popular. These integrations helps to control all house devices from centralised platform and helps to optimise the operation and running costs. Panasonic interfaces are made to work with both KNX and Modbus, the most populars protocols. Also for non integrated control, Panasonic developed a simple connection to Wireless LAN, with this end user can control remotely its own heat pump from wherever.



Control by BMS

Modbus: PAW-AW-MBS-H (Intesis) and PAW-AZAW-MBS-1 (Airzone).
KNX: PAW-AW-KNX-H (Intesis) and PAW-AZAW-KNX-1 (Airzone).

Great flexibility for integration into your KNX / Modbus projects allows fully bi-directional monitoring and control of all the functioning parameters.

- Quick installation
- External power not required
- Direct connection to the unit via CN-CNT connector
- Bidirectional control
- Unit can be controller simultaneously by remote controller and the gateway
- Compatible with H, J, K and L Generations

* For specific functionality list of each gateway, please check the user's manual.



External meter gateway

PAW-A2W-EXTMETER

- Energy consumption and production from external Modbus RTU meters
- Real values visualized via Aquarea remote controller and Aquarea Smart Cloud
- Compatible with Aquarea K and L Generations



Possibility to mix internal calculation and external meters

Configuration	Electricity meter (HP)	Heat meter (heating and cooling)	Heat meter (DHW)
Only external meters	External	External	External
Only external consumption meter	External	Internal calculation	Internal calculation
Only external production meters (2 meters)	Internal calculation	External	External
Only external production meter (single meter for total production)	Internal calculation	External	Internal calculation

Functions:

- Configuration via App (iOS and Android) using Bluetooth®
- Easy to setup thanks to templates for some meters manufacturers
- Configuration can be done before and just send it on commissioning

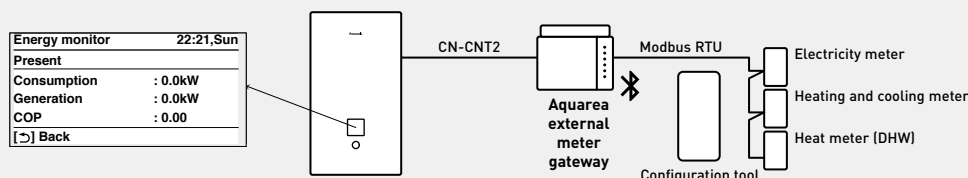

Advanced remote controller

Aquarea remote controller is designed in harmony with the whole system, with optimised user interface and improved features.

The remote controller can be removed from the indoor unit and installed in the living room.

K and L Generations remote controller.

Dual controller system: A dual controller system for independent control of two zones within the home (requires additional remote controller CZ-RTW1).



	K and L Generations				H and J Generations	
	Main controller		Sub controller		Main controller	
Quick menu	✓		✓		✓	
User menu	✓		✓		✓	
Installer / custom menu	✓		—		✓	
Maintenance menu	✓		—		✓	
Error reset	✓		✓		✓	
Internal thermostat	Zone 1	Zone 2	Zone 1	Zone 2	Zone 1	Zone 2
	✓	✓	✓	✓	✓	✓

Installer functions:

System setup, operation setup (including heating / cooling modes, ΔT setup), dry concrete mode and cost-effective bivalent mode*, among others.

* Only for K and L.

End user functions:

Mode selection (including auto, powerful and quiet modes), weekly timer and energy monitoring, among others.

PCB for additional functions

CZ-NS4P: Optional PCB for Aquarea H and J Generations.

CZ-NS5P: Optional PCB for Aquarea K and L Generations.

The optional PCB enables additional control functions for Aquarea heat pumps.

Functions available through the connection of the Optional PCB to the Main PCB:

- 2-zone control, with 2 mixing valves, 2 pumps and 2 room thermostats or sensors
- Control of swimming pool
- Buffer tank temperature sensor (available in the main controller for K and L Generations)
- Solar thermal control
- External error signal output
- 0-10 V signal for heat pump demand control
- SG ready²⁾
- Stop compressor by external compressor switch
- Switch heating and cooling by external heat-cool switch

1) Aquarea H and J Generations heat pumps in combination with the optional PCB CZ-NSP4 hold the SG Ready Label (Smart Grid Ready Label), given by Bundesverband Wärmepumpe (German Heat Pump Association). This Label shows the real capacity of Aquarea to be connected in an intelligent grid control.

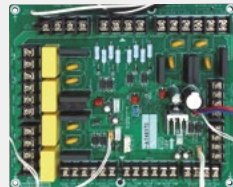

Cascade manager

PAW-A2W-CMH-2

- Cascade up to 10 heat pumps, getting up to 160 kW
- Manages the heat demand based on a PID logic, balancing working hours
- Integration of photovoltaics (PV optimised algorithm)
- Can control 3 way valves for cooling (2 buffer tanks)
- Heating / cooling 0-10 V demand signal – controls target outlet temperature
- DHW control
- Energy meters compatibility
 - Meters communication with Modbus RTU
 - Pre-configuration of 4 market popular meters
- BMS integration. LAN-Port settings with fixed IP and DHCP
- Optimised De-icing function
- Large, easy-to-use touch screen display, providing intuitive control
- All components in one case
- Compatible with Aquarea Heat Pumps H Generation onwards*

* Requires 1 PAW-AW-MBS-H per each Aquarea.



How Panasonic contributes to Nearly Zero Energy Buildings (nZEB)

Our expertise gained over the years has helped to launch a range of products that contribute to a more carbon-free society.

Panasonic is committed to develop products with greater energy efficiency.

Highly efficient Panasonic solutions can help to significantly reduce the energy consumption of the house, at the same time a high level of comfort and good indoor air quality are kept.

- Aquarea High performance heat pump for heating, cooling and domestic hot water production
- Aquarea Smart Cloud, for energy monitoring
- Heat recovery ventilation system
- PV panels to produce renewable energy on-site



Aquarea Heat Pumps and the ventilation unit with heat recovery certified as Passive House Component

Aquarea High Performance All in One Compact and Bi-bloc J Generation heat pumps¹⁾ and the ventilation unit with heat recovery PAW-A2W-VENTA have been certified by the Passive House Institute (PHI) as Passive House Component. This certification ensures highly energy efficient components according to international criteria for respective thermal performance, comfort and indoor air quality.

¹⁾ 3, 5 and 7 kW models.

Certified models can be checked under the certification section of <https://database.passivehouse.com>.

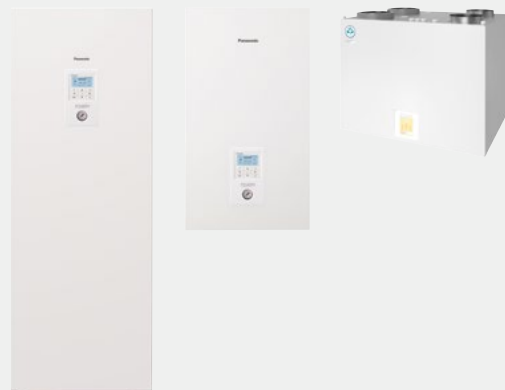
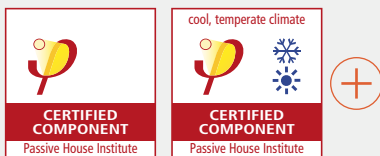

H3 Grande Passive House, Poland.

When looking for a energy-efficient heating solution, Polish construction company Procyon selected a 5 kW Panasonic Aquarea High Performance heat pump for its passive house project, H3 Grande. Procyon found this solution reduced annual heating expenses by almost half compared to an oil-based system, or by 10% in comparison to natural gas.

H3 Grande is a 175 m² detached house certified by the Passive House Institute (PHI) in Darmstadt. It is designed to minimise energy losses while incorporating an attractive, yet simple aesthetic. The building's shape, interior design and pitched roof contribute to the energy balance of the house, while large south-facing windows and wall insulation provide passive thermal comfort by retaining heat. The building has very low heating demand of approximately 15 W/m² and is designed to minimise energy.

Aquarea + PV panels

Aquarea Heat Pumps are designed with the future in mind. They can synchronise with PV panels with simple CZ-NS4P or CZ-NS5P PCB. Thanks to this feature, demand of heating, cooling and domestic hot water production is adapted to the PV panel production.

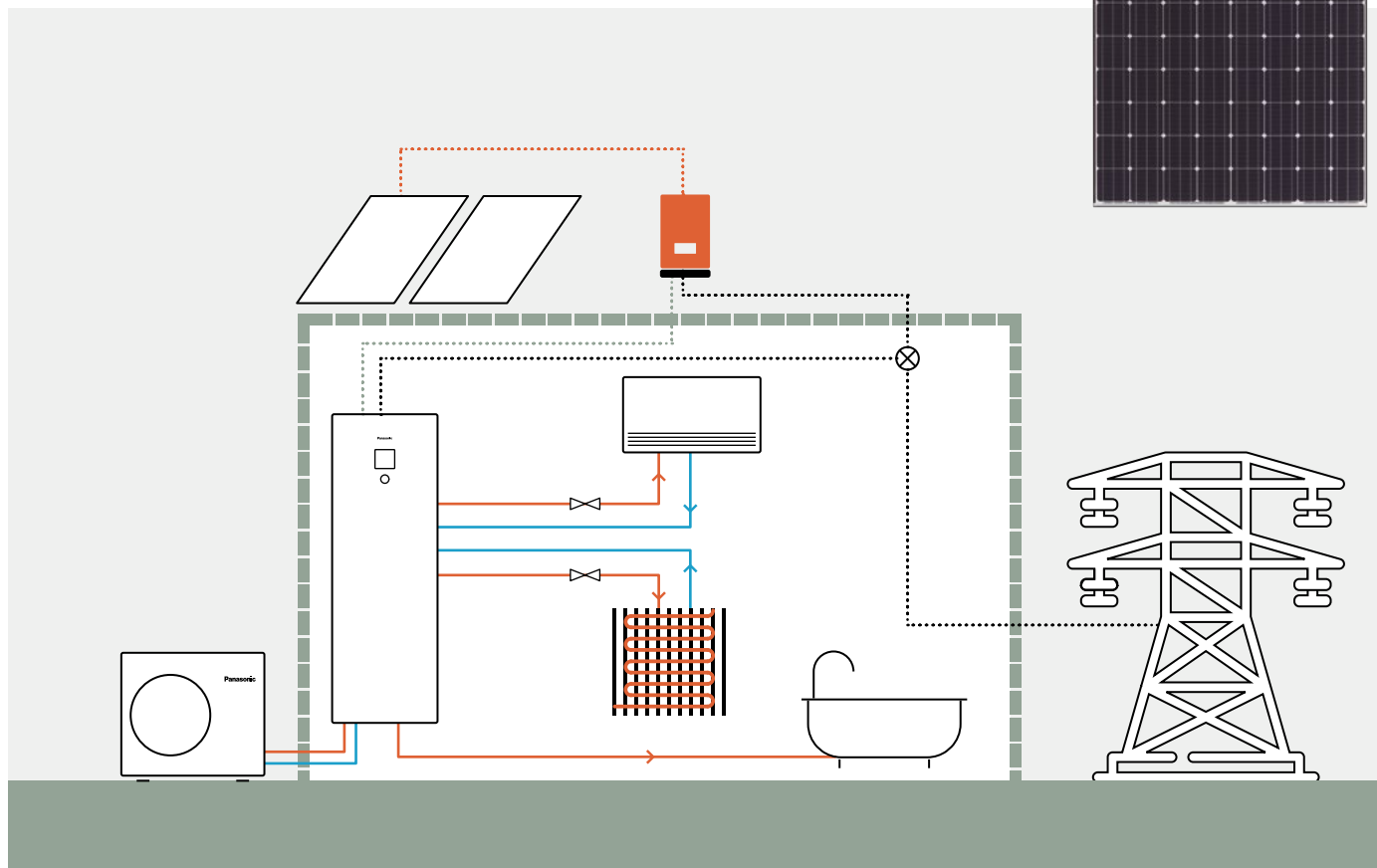

A part of converting Aquarea in Smart Grid ready, the additional PCB allows 0-10 V control, for an advanced energy management.



Turning a family home into an energy-neutral home with Panasonic air to water.

Sinne Technyk, installer, opts for Aquarea T-CAP heat pump combined with HIT KURO photovoltaic panels for a house in Oudemirdum in Friesland, the Netherlands. With this combination, the household enjoys energy-neutral and free heating, as well as domestic hot water, and benefit for a more comfortable indoor climate. The house had an annual gas consumption of 1800 to 2200 cubic meters per year. "The aim was to realize an energy-neutral home and reduce the usage of gas to zero," explains Leo van der Molen of Sinne Technyk. "That makes a heat pump an interesting option." With the comfort of the customers and neighbours in mind, a silent Aquarea T-CAP heat pump was chosen, powered by solar panels. A total of 24 Panasonic HIT KURO solar panels of 325 Wp each were installed. "The products of Panasonic are high end but offer a higher quality than other solutions. The price-quality ratio is, therefore, considerably better," says Van der Molen.

Panasonic PRO Club makes your life easier. All Aquarea Designer - online tool can be found there

Panasonic has an impressive range of support services for designers, specifiers, engineers and distributors working in air to water heat pump projects.



Energy Label

Fridges, dishwashers, washing machines, ovens – it all started with white goods in the 1990s. Today, other energy-consuming appliances also carry the European energy efficiency label, such as televisions and lighting. From 2013, the regulations applied to air conditioners and heat pumps but since September 2015, it has also been applicable to room heaters, water heaters and storage water heaters.

Minimum energy efficiency requirements are also specified for manufacturers of system and combi boilers, water heaters and DHW cylinders.

The purpose of Energy Labels are to assist consumers in their purchasing decisions, as well as ecodesign requirements on products which help reduce private energy demand and help to reduce global warming.

Panasonic helps you to calculate the system label.

From 26th September 2015, installers can be assured that all products manufactured after this date will be sold with the required energy efficiency labels which will aid installers with their paperwork. While it is the manufacturer's responsibility to issue their products with the required labels, the installers will need to calculate and issue an energy efficiency label for the entire heating system. Whether installing a new heating system or installing new boilers, controls or renewables into an existing system, it is, and will continue to be, the installer's responsibility to calculate and issue energy efficiency labels. Calculators which assist installers with this process are available on www.panasonicproclub.com.

Information on the energy efficiency label.

The rating system for heat pumps classifies them into seven efficiency categories. From 26th September 2019, the best energy efficiency category is A+++ and the least energy efficient is D. The energy efficiency label for system boilers shows its efficiency category on a scale from A+++ to D, and from A+ to F for hot water cylinders.

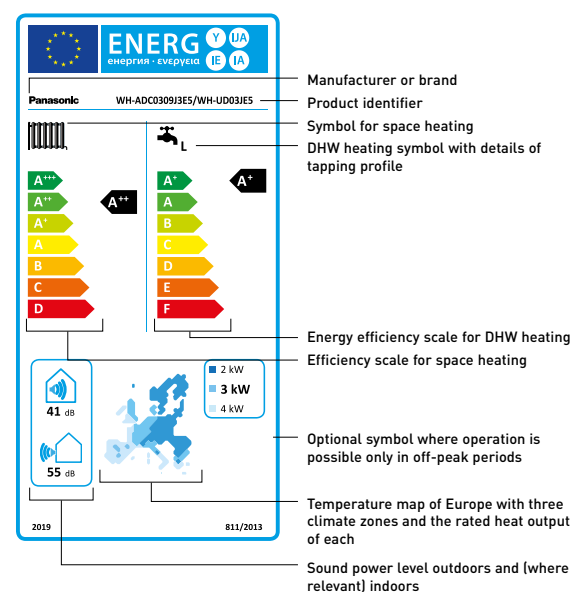

Panasonic helps you to calculate the system label www.panasonicproclub.com or connect simply with your smartphone to the PRO Club using this QR.

PRO Club  



Aquarea Designer - online tool

With Panasonic's online tool, projects can be developed simply and easily. The newly developed tool is optimised to help HVAC professionals easily identify the most appropriate Aquarea air to water heat pump for a particular application.



Aquarea Designer

This program allows HVAC designers, installers and distributors to identify the correct heat pump for a particular application from Panasonic's Aquarea range, calculate the savings compared to other heat sources and very quickly calculate CO₂ emissions.

Using Panasonic's Aquarea Designer, projects can be developed simply and easily, by either using the Quick Design or Expert Design options. Each allows the user to build up the project data in a simple step-by-step process and choose to output reports (project data input includes: either Quick or Large formats) as HTML files or as print-outs. To create these useful reports, project data is input, including:

- Heated area
- Heating requirement
- Heating flow and return temperatures
- Climate data (from a simple drop-down menu) including outdoor temperature
- Type of hot water tank, storage capacity and hot water target temperature



Hydraulic scheme generator

This tool allows costumers to select the scheme between more than 110 different type according to their installation requirements in a simple way. It possible to download hydraulic and electric part in pdf and in cad file. Moreover it is available a list, one for each scheme type, with the Panasonic codes and third party codes that the costumers need to realize the installation in a proper way.

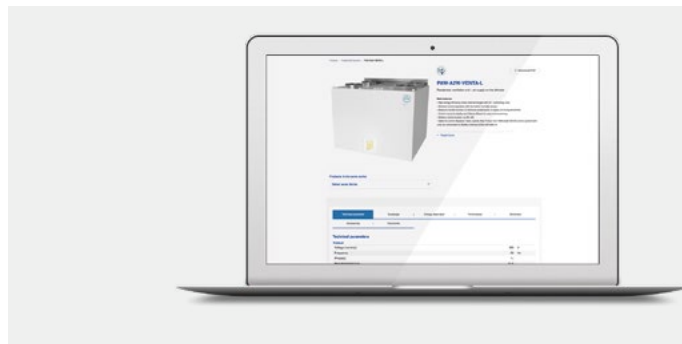
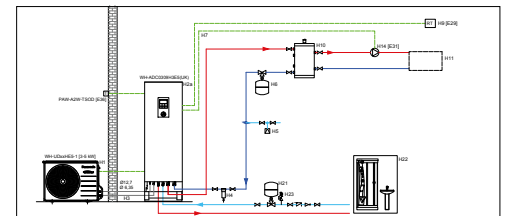

Residential ventilation selection tool.

The tool contains all the information the HVAC professionals need for their residential ventilation projects (specifications, technical manuals, etc.) as well as a calculator of the performance curves.

Heating demand calculator

This software can quickly and easily determine the heating requirements for the rooms in a project. The Heating demand calculator will help determine approximately how much power is needed to heat each room individually. The result in kilowatts will help you choose the space heater best suited to your needs.

CAD images and spec texts

In order to add value in the design of projects, Panasonic has a wide library of 2D CAD, BIM objects (Building Information Modeling) and Spec texts to be used in Revit.

All the support tools are available in Panasonic PRO Club (www.panasonicproclub.com).

Among many others, these are the main tools for the design of Aquarea projects.

Try the new Panasonic Augmented Reality projector.



Helping you to find the Aquarea Heat Pump for your home in just a few clicks!



Aquarea Heat Pumps range

	3 kW	5 kW	7 kW	
Aquarea High Performance	Hydraulic split All in One 1ph P. 52, 53, 54	 NEW WH-ADC0509L3E5 ¹⁾ WH-ADC0509L3E5B WH-ADC0509L3E5AN ¹⁾ WH-WDG05LE5	 NEW WH-ADC0509L3E5 ¹⁾ WH-ADC0509L3E5B WH-ADC0509L3E5AN ¹⁾ WH-WDG07LE5	
	Hydraulic split Bi-bloc 1ph P. 55	 NEW WH-SDC0509L3E5 ¹⁾ WH-WDG05LE5	 NEW WH-SDC0509L3E5 ¹⁾ WH-WDG07LE5	
	All in One 1ph/3ph P. 57, 58, 59, 60, 61, 62, 63	 NEW WH-ADC0309K3E5 ¹⁾ WH-ADC0309K3E5B WH-ADC0309K3E5AN ¹⁾ WH-UDZ03KE5 WH-ADC0309J3E5 WH-ADC0309J3E5B WH-ADC0309J3E5C WH-UD03JE5	 NEW WH-ADC0309K3E5 ¹⁾ WH-ADC0309K3E5B WH-ADC0309K3E5AN ¹⁾ WH-UDZ05KE5 WH-ADC0309J3E5 WH-ADC0309J3E5B WH-ADC0309J3E5C WH-UD05JE5	 NEW WH-ADC0309K3E5 ¹⁾ WH-ADC0309K3E5B WH-ADC0309K3E5AN ¹⁾ WH-UDZ07KE5 WH-ADC0309J3E5 WH-ADC0309J3E5B WH-ADC0309J3E5C WH-UD07JE5
	Bi-bloc 1ph/3ph P. 64, 65, 66	 NEW WH-SDC0309K3E5 ¹⁾²⁾ WH-UDZ03KE5 ²⁾ WH-SDC0305J3E5 WH-UD03JE5	 NEW WH-SDC0309K3E5 ¹⁾²⁾ WH-UDZ05KE5 ²⁾ WH-SDC0305J3E5 WH-UD05JE5	 NEW WH-SDC0309K3E5 ¹⁾²⁾ WH-UDZ07KE5 ²⁾ WH-SDC0709J3E5 WH-UD07JE5
	Mono-bloc 1ph P. 67, 68	 WH-MDC05J3E5	 WH-MDC07J3E5	
Aquarea T-CAP	All in One 1ph/3ph P. 69, 70, 71, 72, 73	 NEW WH-ADC0912K6E5 WH-ADC0912K6E5AN WH-UXZ09KE5 WH-ADC0912K9E8 ²⁾ WH-ADC0912K9E8AN ²⁾ WH-UXZ09KE8 ²⁾ WH-ADC1216H6E5 WH-ADC1216H6E5C WH-UX09HE5 WH-ADC0916H9E8 WH-UX09HE8 WH-UQ09HE8	 NEW WH-ADC0912K6E5 WH-ADC0912K6E5AN WH-UXZ12KE5 WH-ADC0912K9E8 ²⁾ WH-ADC0912K9E8AN ²⁾ WH-UXZ12KE8 ²⁾ WH-ADC1216H6E5 WH-ADC1216H6E5C WH-UX12HE5 WH-ADC0916H9E8 WH-UX12HE8 WH-UQ12HE8	 WH-ADC0916H9E8 WH-UX16HE8 WH-ADC0916H9E8 WH-UQ16HE8
	Bi-bloc 1ph/3ph P. 74, 75, 76	 NEW WH-SXC09K3E5 ¹⁾²⁾ WH-UXZ09KE5 ²⁾ WH-SXC09K3E8 ²⁾³⁾ WH-UXZ09KE8 ²⁾ WH-SXC09H3E5 WH-UX09HE5 WH-SXC09H3E8 WH-UX09HE8 WH-SQC09H3E8 WH-UQ09HE8	 NEW WH-SXC12K6E5 ²⁾ WH-UXZ12KE5 ²⁾ WH-SXC12K9E8 ²⁾ WH-UXZ12KE8 ²⁾ WH-SXC12H6E5 WH-UX12HE5 WH-SXC12H9E8 WH-UX12HE8 WH-SQC12H9E8 WH-UQ12HE8	 WH-SXC16H9E8 WH-UX16HE8 WH-SQC16H9E8 WH-UQ16HE8
	Mono-bloc 1ph/3ph P. 77	 WH-MXC09J3E5 WH-MXC09J3E8	 WH-MXC12J6E5 WH-MXC12J9E8	 WH-MXC16J9E8

 Check all our certified heat pumps on: www.heatpumpkeymark.com

9 kW

12 kW

16 kW

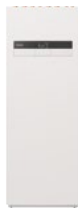

NEW
WH-ADC0509L3E5 ¹⁾
WH-ADC0509L3E5B
WH-ADC0509L3E5AN ¹⁾
WH-WDG09LE5



NEW
WH-SDC0509L3E5 ¹⁾
WH-WDG09LE5



NEW
WH-ADC0309K3E5 ¹⁾
WH-ADC0309K3E5B
WH-ADC0309K3E5AN ¹⁾
WH-UDZ09KE5

WH-ADC0309J3E5
WH-ADC0309J3E5B
WH-ADC0309J3E5C
WH-UD09JE5-1
WH-ADC0916H9E8
WH-UD09HE8



WH-ADC1216H6E5
WH-ADC1216H6E5C
WH-UD12HE5
WH-ADC0916H9E8
WH-UD12HE8



WH-ADC1216H6E5
WH-ADC1216H6E5C
WH-UD16HE5
WH-ADC0916H9E8
WH-UD16HE8



NEW
WH-SDC0309K3E5 ^{1) 2)}
WH-UDZ09KE5 ²⁾

WH-SDC0709J3E5
WH-UD09JE5-1



WH-SDC12H6E5
WH-UD12HE5
WH-SDC12H9E8
WH-UD12HE8



WH-SDC16H6E5
WH-UD16HE5
WH-SDC16H9E8
WH-UD16HE8



WH-MDC09J3E5

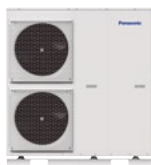

WH-MDC12H6E5

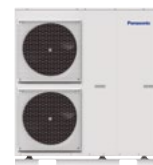

WH-MDC16H6E5

9 kW

12 kW

Aquarea EcoFlex

Aquarea EcoFlex
1ph

P. 56



8 kW

WH-ADF0309J3E5CM
S-71WF3E
CU-2WZ71YBE5

Bi-bloc
1ph/3ph

P. 78



WH-SHF09F3E5
WH-UH09FE5
WH-SHF09F3E8
WH-UH09FE8



WH-SHF12F6E5
WH-UH12FE5
WH-SHF12F9E8
WH-UH12FE8

Aquarea HT

Mono-bloc
1ph

P. 79



WH-MHF09G3E5

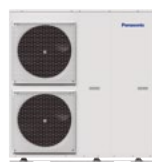

WH-MHF12G6E5

Models with R290 refrigerant. Models with R32 refrigerant.

1) Also available with 6 kW back-up heater. 2) Available Autumn 23. 3) Also available with 9 kW back-up heater.
WH-__E5 1ph // WH-__E8 3ph.

NEW Aquarea High Performance Hydraulic Split All in One L Generation Single phase. Heating and Cooling - R290

Natural refrigerant R290 with GWP 3.

Energy efficiency: A+++ in heating at 35 °C and A+ in DHW / DHW up to 65 °C without heater / Stainless steel DHW tank with U-Vacua™ insulation panel / DHW COP up to 3,60.

Flexibility: Hydraulic connection between indoor and outdoor / Built-in magnetic water filter.

Comfort: Operation without backup heating at -25 °C / 75 °C water outlet temperature maximum at -10 °C outside temperature / 55 °C hot water even at -25 °C outside temperature.

Control: Optimised user interface and improved features (2 zone control, bivalent control).

Connectivity: Wi-Fi adapter included.



		Single phase (power to indoor)					
Kit 3 kW electric heater		KIT-ADC05L3E5	KIT-ADC07L3E5	KIT-ADC09L3E5			
Kit 6 kW electric heater		KIT-ADC05L6E5	KIT-ADC07L6E5	KIT-ADC09L6E5			
Heating capacity / COP (A +7 °C, W 35 °C)	kW / COP	5,00/5,05	7,00/4,93	9,00/4,55			
Heating capacity / COP (A +7 °C, W 55 °C)	kW / COP	5,00/3,07	7,00/2,98	8,90/3,03			
Heating capacity / COP (A +2 °C, W 35 °C)	kW / COP	5,00/3,52	6,85/3,43	7,00/3,41			
Heating capacity / COP (A +2 °C, W 55 °C)	kW / COP	5,00/2,34	6,25/2,34	7,00/2,41			
Heating capacity / COP (A -7 °C, W 35 °C)	kW / COP	5,00/3,01	5,80/3,01	7,00/2,80			
Heating capacity / COP (A -7 °C, W 55 °C)	kW / COP	5,00/2,12	5,80/2,12	7,00/2,13			
Cooling capacity / EER (A 35 °C, W 7 °C)	kW / EER	5,00/3,23	7,00/3,03	8,20/2,82			
Cooling capacity / EER (A 35 °C, W 18 °C)	kW / EER	5,00/5,00	7,00/4,73	9,00/4,19			
Heating average climate (W 35 °C / W 55 °C)	Seasonal energy efficiency	SCOP (η _s %)	5,06/3,63(200/142)	4,96/3,62(195/142)	4,84/3,67(190/144)		
	Energy class ¹⁾		A+++ to D	A+++ / A++	A+++ / A++		
Heating warm climate (W 35 °C / W 55 °C)	Seasonal energy efficiency	SCOP (η _s %)	6,00/4,27(237/168)	6,31/4,52(249/178)	6,44/4,50(255/177)		
	Energy class ¹⁾		A+++ to D	A+++ / A+++	A+++ / A+++		
Heating cold climate (W 35 °C / W 55 °C)	Seasonal energy efficiency	SCOP (η _s %)	4,25/3,28(167/128)	4,25/3,29(167/129)	4,31/3,33(170/130)		
	Energy class ¹⁾		A+++ to D	A++ / A++	A++ / A++		
Indoor unit 3 kW electric heater		WH-ADC0509L3E5	WH-ADC0509L3E5	WH-ADC0509L3E5			
Indoor unit 6 kW electric heater		WH-ADC0509L6E5	WH-ADC0509L6E5	WH-ADC0509L6E5			
Sound pressure	Heat / Cool	dB(A)	28/28	28/28	28/28		
Dimension	H x W x D	mm	1642 x 599 x 602	1642 x 599 x 602	1642 x 599 x 602		
Net weight 3 kW / 6 kW		kg	93/94	93/94	93/94		
Water pipe connector	Room	Inch	1/4	1/4	1/4		
	Shower	Inch	3/4	3/4	3/4		
A class pump	Number of speeds		Variable Speed	Variable Speed	Variable Speed		
	Input power (Min/Max)	W	30/145	30/145	30/145		
Heating water flow (ΔT=5 K, 35 °C)		L/min	14,3	20,1	25,8		
Water volume		L	185	185	185		
Maximum DHW temperature		°C	65	65	65		
Material inside tank			Stainless steel	Stainless steel	Stainless steel		
Tapping profile according EN16147			L	L	L		
DHW tank ERP efficiency average / warm / cold ²⁾		A+ to F	A+ / A+ / A	A+ / A+ / A	A+ / A+ / A		
DHW tank ERP average climate η / COP _{DHW}	η _{wh} % / COP _{DHW}		146/3,60	146/3,60	146/3,60		
DHW tank ERP warm climate η / COP _{DHW}	η _{wh} % / COP _{DHW}		160/4,00	160/4,00	160/4,00		
DHW tank ERP cold climate η / COP _{DHW}	η _{wh} % / COP _{DHW}		112/2,80	112/2,80	112/2,80		
Outdoor unit		WH-WDG05LE5	WH-WDG07LE5	WH-WDG09LE5			
Sound power ³⁾	Heat	dB(A)	52	53	54		
Dimension / Net weight	H x W x D	mm / kg	996 x 980 x 430/98	996 x 980 x 430/98	996 x 980 x 430/97		
Refrigerant (R290) / CO ₂ Eq.		kg / T	0,96/0,003	0,96/0,003	1,00/0,003		
Water pipe connector (indoor / outdoor units)		Inch	1/1	1/1	1/1		
Pipe length range standard / maximum		m	5/30	5/30	5/30		
Elevation difference (in / out)		m	10	10	10		
Operating range - outdoor ambient	Heat	°C	-25 ~ +35	-25 ~ +35	-25 ~ +35		
	Cool	°C	+10 ~ +43	+10 ~ +43	+10 ~ +43		
Water outlet	Heat / Cool	°C	20 ~ 75/5 ~ 20	20 ~ 75/5 ~ 20	20 ~ 75/5 ~ 20		
Electrical information		3 kW heater	6 kW heater	3 kW heater	6 kW heater	3 kW heater	6 kW heater
Electric backup heater	kW	3,00	6,00	3,00	6,00	3,00	6,00
Recommended RCD, supply 1 / 2	A	25/16	25/30	25/16	25/30	25/16	25/30
Recommended minimum cable size, supply 1 / 2 ⁴⁾	mm ²	3x2,5/3x1,5	3x2,5/3x4,0	3x2,5/3x1,5	3x2,5/3x4,0	3x2,5/3x1,5	3x2,5/3x4,0

1) Scale from A+++ to D. 2) Scale from A+ to F. 3) The sound power level is measured with accordance to EN12102 under conditions of the EN14825 (part load). 4) Check local regulations. * EER and COP calculation is based in accordance to EN14511. ** This product is designed to comply with the European Water Quality Directive 98/83/EC amended by 2015/1787/EU. The lifespan of the product is not guaranteed in the case of the use of groundwater, such as spring water or well water, the use of tap water when salt or other impurities are contained, nor in areas of acidic water quality. Maintenance and warranty costs related to these cases are the customer's responsibility.

Accessories	
CZ-RTW1	Additional remote controller for K and L Generations
CZ-NS5P	Additional functions PCB
PAW-A2W-RTWIRED	Room thermostat

Accessories	
PAW-A2W-RTWIRED	Wireless LCD room thermostat
PAW-A2W-AFVLU	1 anti-freeze valve. It is required to order 2 valves per system



INTERNET CONTROL: Wi-Fi adapter included.

NEW Aquarea High Performance Hydraulic Split All in One L Generation Single phase. Heating and Cooling 2 zones · R290

Natural refrigerant R290 with GWP 3.

Energy efficiency: A+++ in heating at 35 °C and A+ in DHW / DHW up to 65 °C without heater / Stainless steel DHW tank with U-Vacua™ insulation panel / DHW COP up to 3,60.

Flexibility: Hydraulic connection between indoor and outdoor / Built-in magnetic water filter / 2 zone control.

Comfort: Operation without backup heating at -25 °C / 75 °C water outlet temperature maximum at -10 °C outside temperature / 55 °C hot water even at -25 °C outside temperature.

Control: Optimised user interface and improved features (2 zone control, bivalent control).

Connectivity: Wi-Fi adapter included.



		Single phase (power to indoor)			
Kit		KIT-ADC05L3E5B	KIT-ADC07L3E5B	KIT-ADC09L3E5B	
Heating capacity / COP (A +7 °C, W 35 °C)	kW / COP	5,00/5,05	7,00/4,93	9,00/4,55	
Heating capacity / COP (A +7 °C, W 55 °C)	kW / COP	5,00/3,07	7,00/2,98	8,90/3,03	
Heating capacity / COP (A +2 °C, W 35 °C)	kW / COP	5,00/3,52	6,85/3,43	7,00/3,41	
Heating capacity / COP (A +2 °C, W 55 °C)	kW / COP	5,00/2,34	6,25/2,34	7,00/2,41	
Heating capacity / COP (A -7 °C, W 35 °C)	kW / COP	5,00/3,01	5,80/3,01	7,00/2,80	
Heating capacity / COP (A -7 °C, W 55 °C)	kW / COP	5,00/2,12	5,80/2,12	7,00/2,13	
Cooling capacity / EER (A 35 °C, W 7 °C)	kW / EER	5,00/3,23	7,00/3,03	8,20/2,82	
Cooling capacity / EER (A 35 °C, W 18 °C)	kW / EER	5,00/5,00	7,00/4,73	9,00/4,19	
Heating average climate (W 35 °C / W 55 °C)	Seasonal energy efficiency	SCOP (η _s %)	5,06/3,63(200/142)	4,96/3,62(195/142)	4,84/3,67(190/144)
	Energy class ¹⁾		A+++ / A++	A+++ / A++	A+++ / A++
Heating warm climate (W 35 °C / W 55 °C)	Seasonal energy efficiency	SCOP (η _s %)	6,00/4,27(237/168)	6,31/4,52(249/178)	6,44/4,50(255/177)
	Energy class ¹⁾		A+++ / A+++	A+++ / A+++	A+++ / A+++
Heating cold climate (W 35 °C / W 55 °C)	Seasonal energy efficiency	SCOP (η _s %)	4,25/3,28(167/128)	4,25/3,29(167/129)	4,31/3,33(170/130)
	Energy class ¹⁾		A++ / A++	A++ / A++	A++ / A++
Indoor unit		WH-ADC0509L3E5B	WH-ADC0509L3E5B	WH-ADC0509L3E5B	
Sound pressure	Heat / Cool	dB(A)	28/28	28/28	
Dimension	H x W x D	mm	1642 x 599 x 602	1642 x 599 x 602	
Net weight		kg	101	101	
Water pipe connector	Room	Inch	1 1/4	1 1/4	
	Shower	Inch	3/4	3/4	
A class pump	Number of speeds		Variable Speed	Variable Speed	
	Input power (Min/Max)	W	30/145	30/145	
Heating water flow (ΔT=5 K, 35 °C)		L/min	14,3	20,1	
Water volume		L	185	185	
Maximum DHW temperature		°C	65	65	
Material inside tank			Stainless steel	Stainless steel	
Tapping profile according EN16147			L	L	
DHW tank ERP efficiency average / warm / cold ²⁾	A+ to F	A+ / A+ / A	A+ / A+ / A	A+ / A+ / A	
DHW tank ERP average climate η / COPdHW	η _{wh} % / COPdHW	146/3,60	146/3,60	146/3,60	
DHW tank ERP warm climate η / COPdHW	η _{wh} % / COPdHW	160/4,00	160/4,00	160/4,00	
DHW tank ERP cold climate η / COPdHW	η _{wh} % / COPdHW	112/2,80	112/2,80	112/2,80	
Outdoor unit		WH-WDG05LE5	WH-WDG07LE5	WH-WDG09LE5	
Sound power ³⁾	Heat	dB(A)	52	53	
Dimension / Net weight	H x W x D	mm / kg	996 x 980 x 430 / 98	996 x 980 x 430 / 98	
Refrigerant (R290) / CO ₂ Eq.		kg / T	0,96/0,003	0,96/0,003	
Water pipe connector (indoor / outdoor units)		Inch	1/1	1/1	
Pipe length range standard / maximum		m	5/30	5/30	
Elevation difference (in / out)		m	10	10	
Operating range - outdoor ambient	Heat	°C	-25 ~ +35	-25 ~ +35	
	Cool	°C	+10 ~ +43	+10 ~ +43	
Water outlet	Heat / Cool	°C	20 ~ 75/5 ~ 20	20 ~ 75/5 ~ 20	
Electrical information		WH-ADC0509L3E5B	WH-ADC0509L3E5B	WH-ADC0509L3E5B	
Electric backup heater		kW	3,00	3,00	
Recommended RCD, supply 1 / 2		A	25/16	25/16	
Recommended minimum cable size, supply 1 / 2 ⁴⁾		mm ²	3x2,5/3x1,5	3x2,5/3x1,5	

1) Scale from A+++ to D. 2) Scale from A+ to F. 3) The sound power level is measured with accordance to EN12102 under conditions of the EN14825 (part load). 4) Check local regulations. * EER and COP calculation is based in accordance to EN14511. ** This product is designed to comply with the European Water Quality Directive 98/83/EC amended by 2015/1787/EU. The lifespan of the product is not guaranteed in the case of the use of groundwater, such as spring water or well water, the use of tap water when salt or other impurities are contained, nor in areas of acidic water quality. Maintenance and warranty costs related to these cases are the customer's responsibility.

Accessories	
CZ-RTW1	Additional remote controller for K and L Generations
CZ-NS5P	Additional functions PCB
PAW-A2W-RTWIRED	Room thermostat

Accessories	
PAW-A2W-RTWIREDLESS	Wireless LCD room thermostat
PAW-A2W-AFVLV	1 anti-freeze valve. It is required to order 2 valves per system



INTERNET CONTROL: Wi-Fi adapter included.

NEW Aquarea High Performance Hydraulic Split All in One L Generation Single phase. Heating and Cooling with Electrical Anode · R290

Natural refrigerant R290 with GWP 3.

Energy efficiency: A+++ in heating at 35 °C and A+ in DHW / DHW up to 65 °C without heater / Stainless steel DHW tank with U-Vacua™ insulation panel / DHW COP up to 3,60.

Flexibility: Hydraulic connection between indoor and outdoor / Built-in magnetic water filter / Installation in harsh water conditions.

Comfort: Operation without backup heating at -25 °C / 75 °C water outlet temperature maximum at -10 °C outside temperature / 55 °C hot water even at -25 °C outside temperature.

Control: Optimised user interface and improved features [2 zone control, bivalent control].

Connectivity: Wi-Fi adapter included.



			Single phase (power to indoor)			
Kit 3 kW electric heater			KIT-ADC05L3E5AN	KIT-ADC07L3E5AN	KIT-ADC09L3E5AN	
Kit 6 kW electric heater			KIT-ADC05L6E5AN	KIT-ADC07L6E5AN	KIT-ADC09L6E5AN	
Heating capacity / COP (A +7 °C, W 35 °C)	kW / COP		5,00/5,05	7,00/4,93	9,00/4,55	
Heating capacity / COP (A +7 °C, W 55 °C)	kW / COP		5,00/3,07	7,00/2,98	8,90/3,03	
Heating capacity / COP (A +2 °C, W 35 °C)	kW / COP		5,00/3,52	6,85/3,43	7,00/3,41	
Heating capacity / COP (A +2 °C, W 55 °C)	kW / COP		5,00/2,34	6,25/2,34	7,00/2,41	
Heating capacity / COP (A -7 °C, W 35 °C)	kW / COP		5,00/3,01	5,80/3,01	7,00/2,80	
Heating capacity / COP (A -7 °C, W 55 °C)	kW / COP		5,00/2,12	5,80/2,12	7,00/2,13	
Cooling capacity / EER (A 35 °C, W 7 °C)	kW / EER		5,00/3,23	7,00/3,03	8,20/2,82	
Cooling capacity / EER (A 35 °C, W 18 °C)	kW / EER		5,00/5,00	7,00/4,73	9,00/4,19	
Heating average climate (W 35 °C / W 55 °C)	Seasonal energy efficiency	SCOP (η _s %)	5,06/3,63[200/142]	4,96/3,62[195/142]	4,84/3,67[190/144]	
	Energy class ¹⁾		A+++ / A++	A+++ / A++	A+++ / A++	
Heating warm climate (W 35 °C / W 55 °C)	Seasonal energy efficiency	SCOP (η _s %)	6,00/4,27[237/168]	6,31/4,52[249/178]	6,44/4,50[255/177]	
	Energy class ¹⁾		A+++ / A+++	A+++ / A+++	A+++ / A+++	
Heating cold climate (W 35 °C / W 55 °C)	Seasonal energy efficiency	SCOP (η _s %)	4,25/3,28[167/128]	4,25/3,29[167/129]	4,31/3,33[170/130]	
	Energy class ¹⁾		A++ / A++	A++ / A++	A++ / A++	
Indoor unit 3 kW electric heater			WH-ADC0509L3E5AN	WH-ADC0509L3E5AN	WH-ADC0509L3E5AN	
Indoor unit 6 kW electric heater			WH-ADC0509L6E5AN	WH-ADC0509L6E5AN	WH-ADC0509L6E5AN	
Sound pressure	Heat / Cool	dB(A)	28/28	28/28	28/28	
Dimension	H x W x D	mm	1642 x 599 x 602	1642 x 599 x 602	1642 x 599 x 602	
Net weight 3 kW / 6 kW		kg	93/94	93/94	93/94	
Water pipe connector	Room	Inch	1/4	1/4	1/4	
	Shower	Inch	3/4	3/4	3/4	
A class pump	Number of speeds		Variable Speed	Variable Speed	Variable Speed	
	Input power (Min/Max)	W	30/145	30/145	30/145	
Heating water flow (ΔT=5 K, 35 °C)		L/min	14,3	20,1	25,8	
Water volume		L	185	185	185	
Maximum DHW temperature		°C	65	65	65	
Material inside tank			Stainless steel	Stainless steel	Stainless steel	
Tapping profile according EN16147			L	L	L	
DHW tank ERP efficiency average / warm / cold ²⁾		A+ to F	A+ / A+ / A	A+ / A+ / A	A+ / A+ / A	
DHW tank ERP average climate η / COP _{DHW}	η _{wh} % / COP _{DHW}		146/3,60	146/3,60	146/3,60	
DHW tank ERP warm climate η / COP _{DHW}	η _{wh} % / COP _{DHW}		160/4,00	160/4,00	160/4,00	
DHW tank ERP cold climate η / COP _{DHW}	η _{wh} % / COP _{DHW}		112/2,80	112/2,80	112/2,80	
Outdoor unit			WH-WDG05LE5	WH-WDG07LE5	WH-WDG09LE5	
Sound power ³⁾	Heat	dB(A)	52	53	54	
Dimension / Net weight	H x W x D	mm / kg	996 x 980 x 430/98	996 x 980 x 430/98	996 x 980 x 430/97	
Refrigerant (R290) / CO ₂ Eq.		kg / T	0,96/0,003	0,96/0,003	1,00/0,003	
Water pipe connector (indoor / outdoor units)		Inch	1/1	1/1	1/1	
Pipe length range standard / maximum		m	5/30	5/30	5/30	
Elevation difference (in / out)		m	10	10	10	
Operating range - outdoor ambient	Heat	°C	-25 ~ +35	-25 ~ +35	-25 ~ +35	
	Cool	°C	+10 ~ +43	+10 ~ +43	+10 ~ +43	
Water outlet	Heat / Cool	°C	20 ~ 75/5 ~ 20	20 ~ 75/5 ~ 20	20 ~ 75/5 ~ 20	
Electrical information			3 kW heater	6 kW heater	3 kW heater	6 kW heater
Electric backup heater	kW		3,00	6,00	3,00	6,00
Recommended RCD, supply 1 / 2	A		25/16	25/30	25/16	25/30
Recommended minimum cable size, supply 1 / 2 ⁴⁾	mm ²		3x2,5/3x1,5	3x2,5/3x4,0	3x2,5/3x1,5	3x2,5/3x4,0

1) Scale from A+++ to D. 2) Scale from A+ to F. 3) The sound power level is measured with accordance to EN12102 under conditions of the EN14825 (part load). 4) Check local regulations. * EER and COP calculation is based in accordance to EN14511. ** This product is designed to comply with the European Water Quality Directive 98/83/EC amended by 2015/1787/EU. The lifespan of the product is not guaranteed in the case of the use of groundwater, such as spring water or well water, the use of tap water when salt or other impurities are contained, nor in areas of acidic water quality. Maintenance and warranty costs related to these cases are the customer's responsibility.

Accessories	
CZ-RTW1	Additional remote controller for K and L Generations
CZ-NS5P	Additional functions PCB
PAW-A2W-RTWIRED	Room thermostat

Accessories	
PAW-A2W-RTWIREDLESS	Wireless LCD room thermostat
PAW-A2W-AFVLY	1 anti-freeze valve. It is required to order 2 valves per system



INTERNET CONTROL: Wi-Fi adapter included.

NEW Aquarea High Performance Hydraulic Split Bi-bloc L Generation Single phase. Heating and Cooling · R290

Natural refrigerant R290 with GWP 3.

Energy efficiency: A+++ in heating at 35 °C / Built-in flow meter.

Flexibility: Hydraulic connection between indoor and outdoor / Built-in magnetic water filter / Installation possible in sites with harsh water quality.

Comfort: Operation without backup heating at -25 °C / 75 °C water outlet temperature maximum at -10 °C outside temperature / 55 °C hot water even at -25 °C outside temperature.

Control: Optimised user interface and improved features [2 zone control, bivalent control].

Connectivity: Wi-Fi adapter included.



Tentative data

		Single phase (power to indoor)				
		KIT-WC05L3E5	KIT-WC07L3E5	KIT-WC09L3E5		
		KIT-WC05L6E5	KIT-WC07L6E5	KIT-WC09L6E5		
Heating capacity / COP (A +7 °C, W 35 °C)	kW / COP	5,00 / 5,05	7,00 / 4,93	9,00 / 4,55		
Heating capacity / COP (A +7 °C, W 55 °C)	kW / COP	5,00 / 3,07	7,00 / 2,98	8,90 / 3,03		
Heating capacity / COP (A +2 °C, W 35 °C)	kW / COP	5,00 / 3,52	6,85 / 3,43	7,00 / 3,41		
Heating capacity / COP (A +2 °C, W 55 °C)	kW / COP	5,00 / 2,34	6,25 / 2,34	7,00 / 2,41		
Heating capacity / COP (A -7 °C, W 35 °C)	kW / COP	5,00 / 3,01	5,80 / 3,01	7,00 / 2,80		
Heating capacity / COP (A -7 °C, W 55 °C)	kW / COP	5,00 / 2,12	5,80 / 2,12	7,00 / 2,13		
Cooling capacity / EER (A 35 °C, W 7 °C)	kW / EER	5,00 / 3,23	7,00 / 3,03	8,20 / 2,82		
Cooling capacity / EER (A 35 °C, W 18 °C)	kW / EER	5,00 / 5,00	7,00 / 4,73	9,00 / 4,19		
Heating average climate (W 35 °C / W 55 °C)	Seasonal energy efficiency	SCOP (η _s %)	5,06 / 3,63 [200 / 142]	4,96 / 3,62 [195 / 142]	4,84 / 3,67 [190 / 144]	
	Energy class ¹⁾		A+++ / A++	A+++ / A++	A+++ / A++	
Heating warm climate (W 35 °C / W 55 °C)	Seasonal energy efficiency	SCOP (η _s %)	6,00 / 4,27 [237 / 168]	6,31 / 4,52 [249 / 178]	6,44 / 4,50 [255 / 177]	
	Energy class ¹⁾		A+++ / A+++	A+++ / A+++	A+++ / A+++	
Heating cold climate (W 35 °C / W 55 °C)	Seasonal energy efficiency	SCOP (η _s %)	4,25 / 3,28 [167 / 128]	4,25 / 3,29 [167 / 129]	4,31 / 3,33 [170 / 130]	
	Energy class ¹⁾		A++ / A++	A++ / A++	A++ / A++	
Indoor unit 3 kW electric heater		WH-SDC0509L3E5	WH-SDC0509L3E5	WH-SDC0509L3E5		
Indoor unit 6 kW electric heater		WH-SDC0509L6E5	WH-SDC0509L6E5	WH-SDC0509L6E5		
Sound pressure	Heat / Cool	dB(A)	28 / 28	30 / 30	30 / 31	
Dimension	H x W x D	mm	892 x 500 x 348	892 x 500 x 348	892 x 500 x 348	
Net weight		kg	—	—	—	
Water pipe connector	Room	Inch	R 1¼	R 1¼	R 1¼	
	Number of speeds		Variable Speed	Variable Speed	Variable Speed	
A class pump	Input power [Min / Max]	W	30 / 145	30 / 145	30 / 145	
	Heating water flow (ΔT=5 K, 35 °C)	L/min	—	—	—	
Outdoor unit		WH-WDG05LE5	WH-WDG07LE5	WH-WDG09LE5		
Sound power ²⁾	Heat	dB(A)	52	53	54	
Dimension	H x W x D	mm	996 x 980 x 430	996 x 980 x 430	996 x 980 x 430	
Net weight		kg	98	98	97	
Refrigerant (R290) / CO ₂ Eq.		kg / T	0,96 / 0,003	0,96 / 0,003	1,00 / 0,003	
Water pipe connector (indoor / outdoor units)		Inch	1 / 1	1 / 1	1 / 1	
Pipe length range standard / maximum		m	5 / 30	5 / 30	5 / 30	
Elevation difference (in / out)		m	10	10	10	
Operating range - outdoor ambient	Heat	°C	-25 ~ +35	-25 ~ +35	-25 ~ +35	
	Cool	°C	+10 ~ +43	+10 ~ +43	+10 ~ +43	
Water outlet	Heat / Cool	°C	20 ~ 75 / 5 ~ 20	20 ~ 75 / 5 ~ 20	20 ~ 75 / 5 ~ 20	
Electrical information			3 kW heater	6 kW heater	3 kW heater	6 kW heater
Electric backup heater		kW	3,00	6,00	3,00	6,00
Recommended fuse		A	25 / 16	25 / 30	25 / 16	25 / 30
Recommended minimum cable size, supply 1 / 2 ³⁾		mm ²	3x2,5 / 3x1,5	3x2,5 / 3x4,0	3x2,5 / 3x1,5	3x2,5 / 3x4,0

1) Scale from A+++ to D. 2) The sound power level is measured with accordance to EN12102 under conditions of the EN14825 (part load). 3) Check local regulations. * EER and COP calculation is based in accordance to EN14511. ** This product is designed to comply with the European Water Quality Directive 98/83/EC amended by 2015/1787/EU. The lifespan of the product is not guaranteed in the case of the use of groundwater, such as spring water or well water, the use of tap water when salt or other impurities are contained, nor in areas of acidic water quality. Maintenance and warranty costs related to these cases are the customer's responsibility. *** Tentative data.

Accessories	
CZ-RTW1	Additional remote controller for K and L Generations
PAW-TD20C1E5-1	Tank 200 L - Stainless steel
PAW-TD30C1E5-1	Tank 300 L - Stainless steel
PAW-TA20C1E5STD	Tank 200 L - Enamelled
PAW-TA30C1E5STD	Tank 300 L - Enamelled
PAW-3WYVLV-HW	3 way valve for DHW tanks
CZ-NV2	3 way valve kit for inside of hydrokit for K and L Generations

Accessories	
PAW-BTANK50L-2	Buffer tank 50 L
CZ-NS5P	Additional functions PCB
PAW-A2W-RTWIRED	Room thermostat
PAW-A2W-RTWIREDLESS	Wireless LCD room thermostat
PAW-A2W-AFVLV	1 anti-freeze valve. It is required to order 2 valves per system



INTERNET CONTROL: Wi-Fi adapter included.

Aquarea EcoFlex. Single phase. Heating and Cooling · R32

Energy efficiency: Heat recovery function, to re-use wasted heat of outdoor unit for DHW production.

Flexibility: Small foot print outdoor unit, tank unit with a standard size of appliances.

Comfort: Non-stop heating operation / nanoe™ X technology to improve protection 24/7 (nanoe X Generator Mark 2).

Connectivity: Wi-Fi adapter included via Aquarea Smart Cloud or Panasonic Comfort Cloud App.



				WH-ADF0309J3E5CM
Heating capacity / COP (A +7 °C, W 35 °C)		kW / COP	8,00 / 4,21	
Heating capacity / COP (A +7 °C, W 55 °C)		kW / COP	8,00 / 2,81	
Heating capacity / COP (A +2 °C, W 35 °C)		kW / COP	6,70 / 3,25	
Heating capacity / COP (A +2 °C, W 55 °C)		kW / COP	6,00 / 2,08	
Heating capacity / COP (A -7 °C, W 35 °C)		kW / COP	5,60 / 2,84	
Heating capacity / COP (A -7 °C, W 55 °C)		kW / COP	5,30 / 1,91	
Cooling capacity / EER (A 35 °C, W 7 °C)		kW / EER	—	
Cooling capacity / EER (A 35 °C, W 18 °C)		kW / EER	—	
Heating average climate (W 35 °C / W 55 °C)		Seasonal energy efficiency SCOP (η _s %)	4,00 / 3,20 (157 / 125)	
		Energy class ¹⁾	A+++ to D	
Heating warm climate (W 35 °C / W 55 °C)		Seasonal energy efficiency SCOP (η _s %)	5,69 / 3,69 (224 / 145)	
		Energy class ¹⁾	A+++ to D	
Heating cold climate (W 35 °C / W 55 °C)		Seasonal energy efficiency SCOP (η _s %)	3,61 / 2,80 (141 / 109)	
		Energy class ¹⁾	A+ / A+	
Air to water	Sound pressure	Heat / Cool	dB(A)	
	Dimension / Net weight	H x W x D	mm / kg	
	Electric backup heater		kW	
	Water volume		L	
	Maximum DHW temperature		°C	
	Heating water flow (ΔT=5 K, 35 °C)		L/min	
	Tapping profile according EN16147		L	
	DHW tank ERP efficiency average / warm / cold ²⁾		A+ to F	
	DHW tank ERP average climate η / COP _{dhw}		η _{wh} % / COP _{dhw}	
	DHW tank ERP warm climate η / COP _{dhw}		η _{wh} % / COP _{dhw}	
	DHW tank ERP cold climate η / COP _{dhw}		η _{wh} % / COP _{dhw}	
	Heat recovery capacity (DHW 55 °C)		kW	
	Heat recovery input power (DHW 55 °C)		kW	
	Heat recovery COP (DHW 55 °C)		°C	
	Water outlet		°C	
				S-71WF3E
Cooling capacity		Nominal	kW	
EER ³⁾		Nominal	W/W	
SEER ⁴⁾			5,60 A+	
P _{design} (cooling)			kW	
Heating capacity		Nominal	kW	
COP ³⁾		Nominal	W/W	
SCOP ⁴⁾			3,90 A	
P _{design} at -10 °C			kW	
External static pressure ⁵⁾			Pa	
Air flow			m ³ /min	
Sound pressure ⁶⁾		Cool / Heat (Hi)	dB(A)	
Sound power ⁷⁾		Cool / Heat (Hi)	dB(A)	
Dimension / Net weight		H x W x D	mm / kg	
nanoe X Generator			Mark 2	
				CU-2WZ71YBE5
Sound pressure		Cool / Heat (air to air)	dB(A)	
Sound power ⁷⁾		Cool / Heat (air to air)	dB(A)	
Sound pressure		Heat (air to water)	dB(A)	
Sound power ⁸⁾		Heat (air to water)	dB(A)	
Dimension / Net weight		H x W x D	mm / kg	
Refrigerant (R32) / CO ₂ Eq.			kg / T	
Piping diameter		Liquid / Gas	Inch (mm)	
Pipe length range / Elevation difference (in / out)			m / m	
Pre-charged pipe length / Additional gas amount			m / g/m	
Operating range - outdoor ambient		Heat (air to air)	°C	
		Cool (air to air)	°C	
		Heat (air to water)	°C	
		Heat recovery (floor / DHW)	°C	

1) Scale from A+++ to D. 2) Scale from A+ to F. 3) EER and COP calculation is based in accordance to EN14511. 4) SEER and SCOP is calculated based on values of EU/626/2011. 5) Medium external static pressure setting from factory. 6) The sound pressure of the units shows the value measured of the position 1,5 m below the unit. The sound pressure is measured in accordance with Eurovent 6/C/006-97 specification. 7) Sound power is measured in accordance with EN14511 and EN12102-1:2017 at +7 °C. 8) Sound power in accordance to 811/2013, 813/2013 and EN12102-1:2017 at +7 °C.

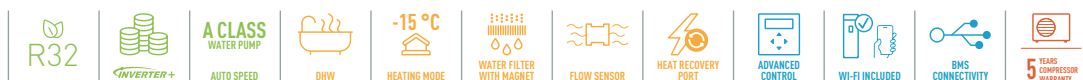

INTERNET CONTROL: Wi-Fi adapter included

NEW Aquarea High Performance All in One K Generation Single phase. Heating and Cooling - R32

Energy efficiency: COP up to 5,33 / A+++ in heating at 35 °C and A+ in DHW / "A" water pump with variable speed / Stainless steel DHW tank with U-Vacua™ insulation panel / DHW COP up to 3,50.

Flexibility: 598 x 600 footprint / Easy access to hydraulic parts / Built-in magnetic water filter.

Comfort: Operation without backup heating at -25 °C / 60 °C hot water even at -10 °C outside temperature.

Control: Optimised user interface and improved features (2 zone control, bivalent control).

Connectivity: Optional Aquarea Smart and Service Cloud and integration into BMS projects.



		Single phase (power to indoor)				
		KIT-ADC03K3E5	KIT-ADC05K3E5	KIT-ADC07K3E5	KIT-ADC09K3E5	
		KIT-ADC03K6E5	KIT-ADC05K6E5	KIT-ADC07K6E5	KIT-ADC09K6E5	
Heating capacity / COP (A +7 °C, W 35 °C)	kW / COP	3,20/5,33	5,00/5,10	7,00/4,86	9,00/4,55	
Heating capacity / COP (A +7 °C, W 55 °C)	kW / COP	3,20/2,81	5,00/3,03	7,00/2,92	8,90/2,93	
Heating capacity / COP (A +2 °C, W 35 °C)	kW / COP	3,20/3,64	5,00/3,57	6,85/3,43	7,00/3,40	
Heating capacity / COP (A +2 °C, W 55 °C)	kW / COP	3,20/2,19	5,00/2,29	6,25/2,23	6,30/2,18	
Heating capacity / COP (A -7 °C, W 35 °C)	kW / COP	3,30/2,80	5,00/2,79	5,75/2,95	6,25/2,84	
Heating capacity / COP (A -7 °C, W 55 °C)	kW / COP	3,20/1,79	5,00/1,89	5,35/1,98	5,90/1,93	
Cooling capacity / EER (A 35 °C, W 7 °C)	kW / EER	3,20/3,52	5,00/3,05	6,70/3,03	8,20/2,72	
Cooling capacity / EER (A 35 °C, W 18 °C)	kW / EER	3,20/4,71	5,00/4,90	6,70/4,72	9,00/4,18	
Heating average climate (W 35 °C / W 55 °C)	Seasonal energy efficiency	SCOP (η _s %)	5,07/3,47 (200/136)	5,12/3,63 (202/142)	4,90/3,62 (193/142)	4,44/3,41 (175/133)
	Energy class ¹⁾		A+++ to D	A+++ / A++	A+++ / A++	A+++ / A++
Heating warm climate (W 35 °C / W 55 °C)	Seasonal energy efficiency	SCOP (η _s %)	6,20/4,20 (245/165)	6,00/4,20 (237/165)	5,75/4,07 (227/160)	5,75/4,07 (227/160)
	Energy class ¹⁾		A+++ to D	A+++ / A+++	A+++ / A+++	A+++ / A+++
Heating cold climate (W 35 °C / W 55 °C)	Seasonal energy efficiency	SCOP (η _s %)	4,00/2,83 (157/110)	4,08/2,95 (160/115)	4,18/2,98 (164/116)	4,18/2,98 (164/116)
	Energy class ¹⁾		A+++ to D	A++ / A+	A++ / A+	A++ / A+
Indoor unit 3 kW electric heater		WH-ADC0309K3E5	WH-ADC0309K3E5	WH-ADC0309K3E5	WH-ADC0309K3E5	
Indoor unit 6 kW electric heater		WH-ADC0309K6E5	WH-ADC0309K6E5	WH-ADC0309K6E5	WH-ADC0309K6E5	
Sound pressure	Heat / Cool	dB(A)	28/28	28/28	28/28	
Dimension	HxWxD	mm	1642x599x602	1642x599x602	1642x599x602	
Net weight 3 kW / 6 kW		kg	100/101	100/101	100/101	
Water pipe connector		Inch	R 1¼	R 1¼	R 1¼	
A class pump	Number of speeds		Variable Speed	Variable Speed	Variable Speed	
	Input power (Min/Max)	W	30/120	30/120	30/120	
Heating water flow (ΔT=5 K. 35 °C)		L/min	9,2	14,3	20,1	
Water volume		L	185	185	185	
Maximum DHW temperature		°C	65	65	65	
Material inside tank			Stainless steel	Stainless steel	Stainless steel	
Tapping profile according EN16147			L	L	L	
DHW tank ERP efficiency average / warm / cold ²⁾			A+ / A++ / A	A+ / A++ / A	A+ / A++ / A	
DHW tank ERP average climate η / COPdHW		η _{wh} % / COPdHW	128/3,20	140/3,50	140/3,50	
DHW tank ERP warm climate η / COPdHW		η _{wh} % / COPdHW	154/3,86	160/4,00	160/4,00	
DHW tank ERP cold climate η / COPdHW		η _{wh} % / COPdHW	99/2,48	112/2,80	112/2,80	
Outdoor unit		WH-UDZ03KE5	WH-UDZ05KE5	WH-UDZ07KE5	WH-UDZ09KE5	
Sound power ³⁾	Heat	dB(A)	55	55	56	
Dimension / Net weight	HxWxD	mm / kg	622x824x298/37	795x875x320/55	795x875x320/55	
Refrigerant (R32) / CO ₂ Eq.		kg / T	0,9/0,608	1,3/0,878	1,3/0,878	
Piping diameter	Liquid / Gas	Inch (mm)	1/4 (6,35) / 1/2 (12,70)	1/4 (6,35) / 5/8 (15,88)	1/4 (6,35) / 5/8 (15,88)	
Pipe length range / Elevation difference (in / out)		m / m	3 - 25/20	3 - 40 (3 - 50) ⁴⁾ / 30	3 - 40 (3 - 50) ⁴⁾ / 30	
Pre-charged pipe length / Additional gas amount		m / g/m	10/20	10/25	10/25	
Operating range - outdoor ambient	Heat	°C	-20 ~ +35	-25 ~ +35	-25 ~ +35	
	Cool	°C	+10 ~ +43	+10 ~ +43	+10 ~ +43	
Water outlet	Heat / Cool	°C	20 ~ 60/5 - 20	20 ~ 60/5 - 20	20 ~ 60/5 - 20	

Electrical information		3 kW heater	6 kW heater	3 kW heater	6 kW heater	3 kW heater	6 kW heater	3 kW heater	6 kW heater
Electric backup heater	kW	3,00	6,00	3,00	6,00	3,00	6,00	3,00	6,00
Recommended fuse	A	16/16	16/30	16/16	16/30	25/16	25/30	25/16	25/30
Recommended minimum cable size, supply 1 / 2 ⁵⁾	mm ²	3x1,5/3x1,5	3x1,5/3x4,0	3x1,5/3x1,5	3x1,5/3x4,0	3x2,5/3x1,5	3x2,5/3x4,0	3x2,5/3x1,5	3x2,5/3x4,0

1) Scale from A+++ to D. 2) Scale from A+ to F. 3) Sound power in accordance to 811/2013, 813/2013 and EN12102-1:2017 at +7 °C. 4) Operation range down to -25 °C in heating with 3 - 40 m pipe length range, operation range down to -15 °C in heating with 3 - 50 m pipe length range. 5) Check local regulations. * EER and COP calculation is based in accordance to EN14511. ** This product is designed to comply with the European Water Quality Directive 98/83/EC amended by 2015/1787/EU. The lifespan of the product is not guaranteed in the case of the use of groundwater, such as spring water or well water, the use of tap water when salt or other impurities are contained, nor in areas of acidic water quality. Maintenance and warranty costs related to these cases are the customer's responsibility.

Accessories	
CZ-RTW1	Additional remote controller for K and L Generations
CZ-TAW1B	Aquarea Smart Cloud for remote control and maintenance through wireless or wired LAN
CZ-TAW1-CBL	10 m extension cable for CZ-TAW1B

Accessories	
CZ-NS5P	Additional functions PCB
PAW-A2W-RTWIRED	Room thermostat
PAW-A2W-RTWIREDLESS	Wireless LCD room thermostat



INTERNET CONTROL: Optional.

NEW Aquarea High Performance All in One K Generation Single phase. Heating and Cooling 2 zones - R32

Energy efficiency: COP up to 5,33 / A+++ in heating at 35 °C and A+ in DHW / "A" water pump with variable speed / Stainless steel DHW tank with U-Vacua™ insulation panel / DHW COP up to 3,50.

Flexibility: 598 x 600 footprint / Easy access to hydraulic parts / Built-in magnetic water filter / 2 zone control.

Comfort: Operation without backup heating at -25 °C / 60 °C hot water even at -10 °C outside temperature.

Control: Optimised user interface and improved features [2 zone control, bivalent control].

Connectivity: Optional Aquarea Smart and Service Cloud and integration into BMS projects.



				Single phase [power to indoor]			
Kit			KIT-ADC03K3E5B	KIT-ADC05K3E5B	KIT-ADC07K3E5B	KIT-ADC09K3E5B	
Heating capacity / COP [A +7 °C, W 35 °C]	kW / COP		3,20/5,33	5,00/5,10	7,00/4,86	9,00/4,55	
Heating capacity / COP [A +7 °C, W 55 °C]	kW / COP		3,20/2,81	5,00/3,03	7,00/2,92	8,90/2,93	
Heating capacity / COP [A +2 °C, W 35 °C]	kW / COP		3,20/3,64	5,00/3,57	6,85/3,43	7,00/3,40	
Heating capacity / COP [A +2 °C, W 55 °C]	kW / COP		3,20/2,19	5,00/2,29	6,25/2,23	6,30/2,18	
Heating capacity / COP [A -7 °C, W 35 °C]	kW / COP		3,30/2,80	5,00/2,79	5,75/2,95	6,25/2,84	
Heating capacity / COP [A -7 °C, W 55 °C]	kW / COP		3,20/1,79	5,00/1,89	5,35/1,98	5,90/1,93	
Cooling capacity / EER [A 35 °C, W 7 °C]	kW / EER		3,20/3,52	5,00/3,05	6,70/3,03	8,20/2,72	
Cooling capacity / EER [A 35 °C, W 18 °C]	kW / EER		3,20/4,71	5,00/4,90	6,70/4,72	9,00/4,18	
Heating average climate (W 35 °C / W 55 °C)	Seasonal energy efficiency	SCOP ($\eta_{s, \text{H}}$ %)	5,07/3,47 [200/136]	5,12/3,63 [202/142]	4,90/3,62 [193/142]	4,44/3,41 [175/133]	
	Energy class ¹⁾		A+++ / A++	A+++ / A++	A+++ / A++	A+++ / A++	
Heating warm climate (W 35 °C / W 55 °C)	Seasonal energy efficiency	SCOP ($\eta_{s, \text{W}}$ %)	6,20/4,20 [245/165]	6,00/4,20 [237/165]	5,75/4,07 [227/160]	5,75/4,07 [227/160]	
	Energy class ¹⁾		A+++ / A+++	A+++ / A+++	A+++ / A+++	A+++ / A+++	
Heating cold climate (W 35 °C / W 55 °C)	Seasonal energy efficiency	SCOP ($\eta_{s, \text{C}}$ %)	4,00/2,83 [157/110]	4,08/2,95 [160/115]	4,18/2,98 [164/116]	4,18/2,98 [164/116]	
	Energy class ¹⁾		A+++ to D	A++ / A+	A++ / A+	A++ / A+	
Indoor unit			WH-ADC0309K3E5B	WH-ADC0309K3E5B	WH-ADC0309K3E5B	WH-ADC0309K3E5B	
Sound pressure	Heat / Cool	dB(A)	28/28	28/28	28/28	28/28	
Dimension	H x W x D	mm	1642 x 599 x 602	1642 x 599 x 602	1642 x 599 x 602	1642 x 599 x 602	
Net weight		kg	109	109	109	109	
Water pipe connector		Inch	R 1 1/4	R 1 1/4	R 1 1/4	R 1 1/4	
A class pump	Number of speeds		Variable Speed	Variable Speed	Variable Speed	Variable Speed	
	Input power (Min/Max)	W	30/120	30/120	30/120	30/120	
Heating water flow ($\Delta T=5$ K, 35 °C)		L/min	9,2	14,3	20,1	25,8	
Water volume		L	185	185	185	185	
Maximum DHW temperature		°C	65	65	65	65	
Material inside tank			Stainless steel	Stainless steel	Stainless steel	Stainless steel	
Tapping profile according EN16147			L	L	L	L	
DHW tank ERP efficiency average / warm / cold ²⁾		A+ to F	A+ / A++ / A	A+ / A++ / A	A+ / A++ / A	A+ / A++ / A	
DHW tank ERP average climate η / COPdHW	$\eta_{\text{wh}} \%$ / COPdHW		128/3,20	140/3,50	140/3,50	140/3,50	
DHW tank ERP warm climate η / COPdHW	$\eta_{\text{wh}} \%$ / COPdHW		154/3,86	160/4,00	160/4,00	160/4,00	
DHW tank ERP cold climate η / COPdHW	$\eta_{\text{wh}} \%$ / COPdHW		99/2,48	112/2,80	112/2,80	112/2,80	
Outdoor unit			WH-UDZ03KE5	WH-UDZ05KE5	WH-UDZ07KE5	WH-UDZ09KE5	
Sound power ³⁾	Heat	dB(A)	55	55	56	56	
Dimension / Net weight	H x W x D	mm / kg	622 x 824 x 298/37	795 x 875 x 320/55	795 x 875 x 320/55	795 x 875 x 320/55	
Refrigerant (R32) / CO ₂ Eq.		kg / T	0,9/0,608	1,3/0,878	1,3/0,878	1,3/0,878	
Piping diameter	Liquid / Gas	Inch (mm)	1/4 (6,35) / 1/2 (12,70)	1/4 (6,35) / 5/8 (15,88)	1/4 (6,35) / 5/8 (15,88)	1/4 (6,35) / 5/8 (15,88)	
Pipe length range / Elevation difference [in / out]		m / m	3-25/20	3-40 [3-50] ⁴⁾ / 30	3-40 [3-50] ⁴⁾ / 30	3-40 [3-50] ⁴⁾ / 30	
Pre-charged pipe length / Additional gas amount		m / g/m	10/20	10/25	10/25	10/25	
Operating range - outdoor ambient	Heat	°C	-20 ~ +35	-25 ~ +35	-25 ~ +35	-25 ~ +35	
	Cool	°C	+10 ~ +43	+10 ~ +43	+10 ~ +43	+10 ~ +43	
Water outlet	Heat / Cool	°C	20-60/5-20	20-60/5-20	20-60/5-20	20-60/5-20	
Electrical information			WH-ADC0309K3E5B	WH-ADC0309K3E5B	WH-ADC0309K3E5B	WH-ADC0309K3E5B	
Electric backup heater		kW	3,00	3,00	3,00	3,00	
Recommended fuse		A	16/16	16/16	25/16	25/16	
Recommended minimum cable size, supply 1 / 2 ⁵⁾		mm ²	3 x 1,5 / 3 x 1,5	3 x 1,5 / 3 x 1,5	3 x 2,5 / 3 x 1,5	3 x 2,5 / 3 x 1,5	

1) Scale from A+++ to D. 2) Scale from A+ to F. 3) Sound power in accordance to 811/2013, 813/2013 and EN12102-1:2017 at +7 °C. 4) Operation range down to -25 °C in heating with 3-40 m pipe length range, operation range down to -15 °C in heating with 3-50 m pipe length range. 5) Check local regulations. * EER and COP calculation is based in accordance to EN14511. ** This product is designed to comply with the European Water Quality Directive 98/83/EC amended by 2015/1787/EU. The lifespan of the product is not guaranteed in the case of the use of groundwater, such as spring water or well water, the use of tap water when salt or other impurities are contained, nor in areas of acidic water quality. Maintenance and warranty costs related to these cases are the customer's responsibility.

Accessories	
CZ-RTW1	Additional remote controller for K and L Generations
CZ-TAW1B	Aquarea Smart Cloud for remote control and maintenance through wireless or wired LAN
CZ-TAW1-CBL	10 m extension cable for CZ-TAW1B

Accessories	
CZ-NS5P	Additional functions PCB
PAW-A2W-RTWIRED	Room thermostat
PAW-A2W-RTWIRELESS	Wireless LCD room thermostat



INTERNET CONTROL: Optional.

NEW Aquarea High Performance All in One K Generation Single phase. Heating and Cooling with Electrical Anode - R32

Energy efficiency: COP up to 5,33 / A+++ in heating at 35 °C and A+ in DHW / "A" water pump with variable speed / Stainless steel DHW tank with U-Vacua™ insulation panel / DHW COP up to 3,50.

Flexibility: 598 x 600 footprint / Built-in magnetic water filter / Installation possible in sites with harsh water quality.

Comfort: Operation without backup heating at -25 °C / 60 °C hot water even at -10 °C outside temperature.

Control: Optimised user interface and improved features (2 zone control, bivalent control).

Connectivity: Optional Aquarea Smart and Service Cloud and integration into BMS projects.



		Single phase (power to indoor)				
Kit 3 kW electric heater		KIT-ADC03K3E5AN	KIT-ADC05K3E5AN	KIT-ADC07K3E5AN	KIT-ADC09K3E5AN	
Kit 6 kW electric heater		KIT-ADC03K6E5AN	KIT-ADC05K6E5AN	KIT-ADC07K6E5AN	KIT-ADC09K6E5AN	
Heating capacity / COP (A +7 °C, W 35 °C)	kW / COP	3,20/5,33	5,00/5,10	7,00/4,86	9,00/4,55	
Heating capacity / COP (A +7 °C, W 55 °C)	kW / COP	3,20/2,81	5,00/3,03	7,00/2,92	8,90/2,93	
Heating capacity / COP (A +2 °C, W 35 °C)	kW / COP	3,20/3,64	5,00/3,57	6,85/3,43	7,00/3,40	
Heating capacity / COP (A +2 °C, W 55 °C)	kW / COP	3,20/2,19	5,00/2,29	6,25/2,23	6,30/2,18	
Heating capacity / COP (A -7 °C, W 35 °C)	kW / COP	3,30/2,80	5,00/2,79	5,75/2,95	6,25/2,84	
Heating capacity / COP (A -7 °C, W 55 °C)	kW / COP	3,20/1,79	5,00/1,89	5,35/1,98	5,90/1,93	
Cooling capacity / EER (A 35 °C, W 7 °C)	kW / EER	3,20/3,52	5,00/3,05	6,70/3,03	8,20/2,72	
Cooling capacity / EER (A 35 °C, W 18 °C)	kW / EER	3,20/4,71	5,00/4,90	6,70/4,72	9,00/4,18	
Heating average climate (W 35 °C / W 55 °C)	Seasonal energy efficiency	SCOP (η _s %)	5,07/3,47 (200/136)	5,12/3,63 (202/142)	4,90/3,62 (193/142)	4,44/3,41 (175/133)
	Energy class ¹⁾		A+++ to D	A+++ / A++	A+++ / A++	A+++ / A++
Heating warm climate (W 35 °C / W 55 °C)	Seasonal energy efficiency	SCOP (η _s %)	6,20/4,20 (245/165)	6,00/4,20 (237/165)	5,75/4,07 (227/160)	5,75/4,07 (227/160)
	Energy class ¹⁾		A+++ to D	A+++ / A+++	A+++ / A+++	A+++ / A+++
Heating cold climate (W 35 °C / W 55 °C)	Seasonal energy efficiency	SCOP (η _s %)	4,00/2,83 (157/110)	4,08/2,95 (160/115)	4,18/2,98 (164/116)	4,18/2,98 (164/116)
	Energy class ¹⁾		A+++ to D	A++ / A+	A++ / A+	A++ / A+
Indoor unit 3 kW electric heater		WH-ADC0309K3E5AN	WH-ADC0309K3E5AN	WH-ADC0309K3E5AN	WH-ADC0309K3E5AN	
Indoor unit 6 kW electric heater		WH-ADC0309K6E5AN	WH-ADC0309K6E5AN	WH-ADC0309K6E5AN	WH-ADC0309K6E5AN	
Sound pressure	Heat / Cool	dB(A)	28/28	28/28	28/28	28/28
Dimension	HxWxD	mm	1642x599x602	1642x599x602	1642x599x602	1642x599x602
Net weight		kg	100/101	100/101	100/101	100/101
Water pipe connector		Inch	R 1¼	R 1¼	R 1¼	R 1¼
A class pump	Number of speeds		Variable Speed	Variable Speed	Variable Speed	Variable Speed
	Input power (Min/Max)	W	30/120	30/120	30/120	30/120
Heating water flow (ΔT=5 K. 35 °C)		L/min	9,2	14,3	20,1	25,8
Water volume		L	185	185	185	185
Maximum DHW temperature		°C	65	65	65	65
Material inside tank			Stainless steel	Stainless steel	Stainless steel	Stainless steel
Tapping profile according EN16147			L	L	L	L
DHW tank ERP efficiency average / warm / cold ²⁾			A+ / A++ / A	A+ / A++ / A	A+ / A++ / A	A+ / A++ / A
DHW tank ERP average climate η / COPdHW		η _{wh} % / COPdHW	128/3,20	140/3,50	140/3,50	140/3,50
DHW tank ERP warm climate η / COPdHW		η _{wh} % / COPdHW	154/3,86	160/4,00	160/4,00	160/4,00
DHW tank ERP cold climate η / COPdHW		η _{wh} % / COPdHW	99/2,48	112/2,80	112/2,80	112/2,80
Outdoor unit		WH-UDZ03KE5	WH-UDZ05KE5	WH-UDZ07KE5	WH-UDZ09KE5	
Sound power ³⁾	Heat	dB(A)	55	55	56	56
Dimension / Net weight	HxWxD	mm / kg	622x824x298/37	795x875x320/55	795x875x320/55	795x875x320/55
Refrigerant (R32) / CO ₂ Eq.		kg / T	0,9/0,608	1,3/0,878	1,3/0,878	1,3/0,878
Piping diameter	Liquid / Gas	Inch (mm)	1/4 (6,35) / 1/2 (12,70)	1/4 (6,35) / 5/8 (15,88)	1/4 (6,35) / 5/8 (15,88)	1/4 (6,35) / 5/8 (15,88)
Pipe length range / Elevation difference (in / out)		m / m	3 - 25/20	3 - 40 (3 - 50) ⁴⁾ / 30	3 - 40 (3 - 50) ⁴⁾ / 30	3 - 40 (3 - 50) ⁴⁾ / 30
Pre-charged pipe length / Additional gas amount		m / g/m	10/20	10/25	10/25	10/25
Operating range - outdoor ambient	Heat	°C	-20 ~ +35	-25 ~ +35	-25 ~ +35	-25 ~ +35
	Cool	°C	+10 ~ +43	+10 ~ +43	+10 ~ +43	+10 ~ +43
Water outlet	Heat / Cool	°C	20 ~ 60/5 ~ 20	20 ~ 60/5 ~ 20	20 ~ 60/5 ~ 20	20 ~ 60/5 ~ 20

Electrical information		3 kW heater	6 kW heater	3 kW heater	6 kW heater	3 kW heater	6 kW heater	3 kW heater	6 kW heater
Electric backup heater	kW	3,00	6,00	3,00	6,00	3,00	6,00	3,00	6,00
Recommended fuse	A	16/16	16/30	16/16	16/30	25/16	25/30	25/16	25/30
Recommended minimum cable size, supply 1 / 2 ⁵⁾	mm ²	3x1,5/3x1,5	3x1,5/3x4,0	3x1,5/3x1,5	3x1,5/3x4,0	3x2,5/3x1,5	3x2,5/3x4,0	3x2,5/3x1,5	3x2,5/3x4,0

1) Scale from A+++ to D. 2) Scale from A+ to F. 3) Sound power in accordance to 811/2013, 813/2013 and EN12102-1:2017 at +7 °C. 4) Operation range down to -25 °C in heating with 3 - 40 m pipe length range, operation range down to -15 °C in heating with 3 - 50 m pipe length range. 5) Check local regulations. * EER and COP calculation is based in accordance to EN14511. ** This product is designed to comply with the European Water Quality Directive 98/83/EC amended by 2015/1787/EU. The lifespan of the product is not guaranteed in the case of the use of groundwater, such as spring water or well water, the use of tap water when salt or other impurities are contained, nor in areas of acidic water quality. Maintenance and warranty costs related to these cases are the customer's responsibility.

Accessories	
CZ-RTW1	Additional remote controller for K and L Generations
CZ-TAW1B	Aquarea Smart Cloud for remote control and maintenance through wireless or wired LAN
CZ-TAW1-CBL	10 m extension cable for CZ-TAW1B

Accessories	
CZ-NS5P	Additional functions PCB
PAW-A2W-RTWIRED	Room thermostat
PAW-A2W-RTWIRELESS	Wireless LCD room thermostat



INTERNET CONTROL: Optional.

Aquarea High Performance All in One J Generation Single phase. Heating and Cooling 1 or 2 zones · R32

Energy efficiency: COP up to 5,33 / A+++ in heating at 35 °C and A+ in DHW / "A" water pump with variable speed / Stainless steel DHW tank with U-Vacua™ insulation panel / Built-in flow meter.

Flexibility: Long piping lengths / Built-in magnetic water filter.

Comfort: Heating curve down to -20 °C / 60 °C water outlet temperature.

Control: Additional functions with optional PCB (2 zone control, bivalent control, Smart Grid contact and more).

Connectivity: Optional Aquarea Smart and Service Cloud and integration into BMS projects.



011-1W0207
011-1W0208
011-1W0209



			Single phase (power to indoor)			
Kit 1 zone (for 2 zone add B at the end)			KIT-ADC03JE5	KIT-ADC05JE5	KIT-ADC07JE5	KIT-ADC09JE5-1
Heating capacity / COP (A +7 °C, W 35 °C)		kW / COP	3,20/5,33	5,00/5,00	7,00/4,76	9,00/4,48
Heating capacity / COP (A +7 °C, W 55 °C)		kW / COP	3,20/2,81	5,00/2,72	7,00/2,82	8,95/2,78
Heating capacity / COP (A +2 °C, W 35 °C)		kW / COP	3,20/3,64	4,20/3,18	6,85/3,41	7,00/3,40
Heating capacity / COP (A +2 °C, W 55 °C)		kW / COP	3,20/2,19	4,10/1,99	6,20/2,21	6,30/2,16
Heating capacity / COP (A -7 °C, W 35 °C)		kW / COP	3,30/2,80	4,20/2,59	5,60/2,87	6,12/2,78
Heating capacity / COP (A -7 °C, W 55 °C)		kW / COP	3,20/1,79	3,55/1,71	5,25/1,94	5,90/1,93
Cooling capacity / EER (A 35 °C, W 7 °C)		kW / EER	3,20/3,52	4,50/3,00	6,70/3,03	8,20/2,72
Cooling capacity / EER (A 35 °C, W 18 °C)		kW / EER	3,20/4,71	4,80/4,29	6,70/4,72	9,00/4,18
Heating average climate (W 35 °C / W 55 °C)	Seasonal energy efficiency	SCOP (η _s %)	5,07/3,47(200/136)	5,07/3,47(200/136)	4,90/3,32(193/130)	4,90/3,32(193/130)
	Energy class ¹⁾		A+++ / A++	A+++ / A++	A+++ / A++	A+++ / A++
Heating warm climate (W 35 °C / W 55 °C)	Seasonal energy efficiency	SCOP (η _s %)	6,20/4,20(245/165)	6,20/4,20(245/165)	5,75/4,07(227/160)	5,75/4,07(227/160)
	Energy class ¹⁾		A+++ / A+++	A+++ / A+++	A+++ / A+++	A+++ / A+++
Heating cold climate (W 35 °C / W 55 °C)	Seasonal energy efficiency	SCOP (η _s %)	4,00/2,83(157/110)	4,00/2,83(157/110)	4,18/2,98(164/116)	4,18/2,98(164/116)
	Energy class ¹⁾		A++ / A+	A++ / A+	A++ / A+	A++ / A+
Indoor unit 1 zone hydrokit			WH-ADC0309J3E5	WH-ADC0309J3E5	WH-ADC0309J3E5	WH-ADC0309J3E5
Indoor unit 2 zones built-in hydrokit			WH-ADC0309J3E5B	WH-ADC0309J3E5B	WH-ADC0309J3E5B	WH-ADC0309J3E5B
Sound pressure	Heat / Cool	dB(A)	28/28	28/28	28/28	28/28
Dimension	H x W x D	mm	1800x598x717	1800x598x717	1800x598x717	1800x598x717
Net weight 1 zone / 2 zones		kg	122/130	122/130	122/130	122/130
Water pipe connector		Inch	R 1½	R 1½	R 1½	R 1½
A class pump	Number of speeds		Variable Speed	Variable Speed	Variable Speed	Variable Speed
	Input power (Min/Max)	W	30/120	30/120	30/120	30/120
Heating water flow (ΔT=5 K, 35 °C)		L/min	9,20	14,30	20,10	25,80
Electric backup heater		kW	3,00	3,00	3,00	3,00
Recommended fuse		A	16/16	16/16	25/16	25/16
Recommended minimum cable size, supply 1 / 2 ²⁾		mm ²	3x1,5/3x1,5	3x1,5/3x1,5	3x2,5/3x1,5	3x2,5/3x1,5
Water volume		L	185	185	185	185
Maximum DHW temperature		°C	65	65	65	65
Material inside tank			Stainless steel	Stainless steel	Stainless steel	Stainless steel
Tapping profile according EN16147			L	L	L	L
DHW tank ERP efficiency average / warm / cold ³⁾		A+ to F	A+ / A+ / A	A+ / A+ / A	A+ / A+ / A	A+ / A+ / A
DHW tank ERP average climate η / COP _{DHW}		η _{wh} % / COP _{DHW}	132/3,30	132/3,30	120/3,00	120/3,00
DHW tank ERP warm climate η / COP _{DHW}		η _{wh} % / COP _{DHW}	155/3,88	155/3,88	140/3,50	140/3,50
DHW tank ERP cold climate η / COP _{DHW}		η _{wh} % / COP _{DHW}	99/2,48	99/2,48	99/2,47	99/2,47
Outdoor unit			WH-UD03JE5	WH-UD05JE5	WH-UD07JE5	WH-UD09JE5-1
Sound power ⁴⁾	Heat	dB(A)	55	55	59	59
Dimension / Net weight	H x W x D	mm / kg	622x824x298/37	622x824x298/37	795x875x320/61	795x875x320/61
Refrigerant (R32) / CO ₂ Eq.		kg / T	0,9/0,608	0,9/0,608	1,27/0,857	1,27/0,857
Piping diameter	Liquid / Gas	Inch (mm)	1/4(6,35)/1/2(12,70)	1/4(6,35)/1/2(12,70)	1/4(6,35)/5/8(15,88)	1/4(6,35)/5/8(15,88)
Pipe length range / Elevation difference (in / out)		m / m	3~25/20	3~25/20	3~50/30	3~50/30
Pre-charged pipe length / Additional gas amount		m / g/m	10/20	10/20	10/25	10/25
Operating range - outdoor ambient	Heat	°C	-20~+35	-20~+35	-20~+35	-20~+35
	Cool	°C	+10~+43	+10~+43	+10~+43	+10~+43
Water outlet	Heat / Cool	°C	20~60/5~20	20~60/5~20	20~60/5~20	20~60/5~20

1) Scale from A+++ to D. 2) Check local regulations. 3) Scale from A+ to F. 4) Sound power in accordance to 811/2013, 813/2013 and EN12102-1:2017 at +7 °C. * EER and COP calculation is based in accordance to EN14511. ** This product is designed to comply with the European Water Quality Directive 98/83/EC amended by 2015/1787/EU. The lifespan of the product is not guaranteed in the case of the use of groundwater, such as spring water or well water, the use of tap water when salt or other impurities are contained, nor in areas of acidic water quality. Maintenance and warranty costs related to these cases are the customer's responsibility.

Accessories	
PAW-ADC-PREKIT-1	Piping pre installation kit for J Generation
CZ-TAW1B	Aquarea Smart Cloud for remote control and maintenance through wireless or wired LAN
CZ-TAW1-CBL	10 m extension cable for CZ-TAW1B

Accessories	
CZ-NS4P	Additional functions PCB
PAW-A2W-RTWIRED	Room thermostat
PAW-A2W-RTWIRELESS	Wireless LCD room thermostat



INTERNET CONTROL: Optional.

Aquarea High Performance All in One H Generation Single phase / Three phase. Heating and Cooling - R410A

Energy efficiency: A+++ in heating at 35 °C and A+ in DHW / "A" water pump with variable speed / Stainless steel DHW tank with U-Vacua™ insulation panel / Built-in flow meter.

Flexibility: Optional magnet for the water filter.

Comfort: Operating range down to -20 °C.

Control: Additional functions with optional PCB (2 zone control, bivalent control, Smart Grid contact and more).

Connectivity: Optional Aquarea Smart and Service Cloud and integration into BMS projects.



Kit	Single phase (power to indoor)		Three phase (power to indoor)				
	KIT-ADC12HE5	KIT-ADC16HE5	KIT-ADC09HE8	KIT-ADC12HE8	KIT-ADC16HE8		
Heating capacity / COP (A +7 °C, W 35 °C)	kW / COP	12,00/4,74	16,00/4,28	9,00/4,84	12,00/4,74	16,00/4,28	
Heating capacity / COP (A +7 °C, W 55 °C)	kW / COP	12,00/2,93	14,50/2,72	9,00/2,94	12,00/2,93	14,50/2,72	
Heating capacity / COP (A +2 °C, W 35 °C)	kW / COP	11,40/3,44	13,00/3,28	9,00/3,59	11,40/3,44	13,00/3,28	
Heating capacity / COP (A +2 °C, W 55 °C)	kW / COP	9,10/2,23	9,80/2,21	8,80/2,23	9,10/2,23	9,80/2,21	
Heating capacity / COP (A -7 °C, W 35 °C)	kW / COP	10,00/2,73	11,40/2,57	9,00/2,85	10,00/2,73	11,40/2,57	
Heating capacity / COP (A -7 °C, W 55 °C)	kW / COP	8,20/1,95	9,00/1,85	7,90/2,05	8,20/1,95	9,00/1,85	
Cooling capacity / EER (A 35 °C, W 7 °C)	kW / EER	10,00/2,81	12,20/2,56	7,00/3,17	10,00/2,85	12,20/2,56	
Cooling capacity / EER (A 35 °C, W 18 °C)	kW / EER	10,00/4,17	12,20/4,12	7,00/4,67	10,00/4,26	12,20/4,12	
Heating average climate (W 35 °C / W 55 °C)	Seasonal energy efficiency	SCOP (η _s %)	4,82/3,42(190/134)	4,82/3,33(190/130)	4,81/3,41(190/133)	4,82/3,42(190/134)	4,82/3,33(190/130)
	Energy class ¹⁾	A+++ to D	A+++/A++	A+++/A++	A+++/A++	A+++/A++	A+++/A++
Heating warm climate (W 35 °C / W 55 °C)	Seasonal energy efficiency	SCOP (η _s %)	6,21/4,05(245/159)	6,21/4,30(245/169)	6,21/4,05(245/159)	6,21/4,05(245/159)	6,20/4,30(245/169)
	Energy class ¹⁾	A+++ to D	A+++/A+++	A+++/A+++	A+++/A+++	A+++/A+++	A+++/A+++
Heating cold climate (W 35 °C / W 55 °C)	Seasonal energy efficiency	SCOP (η _s %)	4,29/3,10(168/121)	4,28/3,10(168/121)	4,28/3,10(168/121)	4,29/3,10(168/121)	4,28/3,10(168/121)
	Energy class ¹⁾	A+++ to D	A++/A+	A++/A+	A++/A+	A++/A+	A++/A+
Indoor unit			WH-ADC1216H6E5	WH-ADC1216H6E5	WH-ADC0916H9E8	WH-ADC0916H9E8	WH-ADC0916H9E8
Sound pressure	Heat / Cool	dB(A)	33/33	33/33	33/33	33/33	33/33
Dimension	HxWxD	mm	1800x598x717	1800x598x717	1800x598x717	1800x598x717	1800x598x717
Net weight		kg	124	124	126	126	126
Water pipe connector		Inch	R 1½	R 1½	R 1½	R 1½	R 1½
A class pump	Number of speeds		Variable Speed	Variable Speed	Variable Speed	Variable Speed	Variable Speed
	Input power (Min/Max)	W	36/152	36/152	36/152	36/152	36/152
Heating water flow (ΔT=5 K. 35 °C)		L/min	34,4	45,9	25,8	34,4	45,9
Electric backup heater		kW	6,00	6,00	9,00	9,00	9,00
Recommended fuse		A	30/30	30/30	16/16	16/16	16/16
Recommended minimum cable size, supply 1 / 2 ²⁾		mm ²	3x4,0/3x4,0	3x4,0/3x4,0	5x1,5/5x1,5	5x1,5/5x1,5	5x1,5/5x1,5
Water volume		L	185	185	185	185	185
Maximum DHW temperature		°C	65	65	65	65	65
Material inside tank			Stainless steel	Stainless steel	Stainless steel	Stainless steel	Stainless steel
Tapping profile according EN16147			L	L	L	L	L
DHW tank ERP efficiency average / warm / cold ³⁾		A+ to F	A/A/A	A/A/B	A/A/A	A/A/A	A/A/B
DHW tank ERP average climate η / COPdHW		η _{wh} %/COPdHW	95/2,37	91/2,28	95/2,37	95/2,37	91/2,27
DHW tank ERP warm climate η / COPdHW		η _{wh} %/COPdHW	110/2,75	107/2,67	110/2,75	110/2,75	107/2,67
DHW tank ERP cold climate η / COPdHW		η _{wh} %/COPdHW	75/1,87	72/1,80	75/1,87	75/1,87	72/1,80
Outdoor unit			WH-UD12HE5	WH-UD16HE5	WH-UD09HE8	WH-UD12HE8	WH-UD16HE8
Sound power ⁴⁾	Heat	dB(A)	65	65	65	65	65
Dimension / Net weight	HxWxD	mm / kg	1340x900x320/101	1340x900x320/101	1340x900x320/107	1340x900x320/107	1340x900x320/107
Refrigerant (R410A) / CO ₂ Eq.		kg / T	2,55/5,324	2,55/5,324	2,55/5,324	2,55/5,324	2,55/5,324
Piping diameter	Liquid / Gas	Inch (mm)	3/8(9,52)/5/8(15,88)	3/8(9,52)/5/8(15,88)	3/8(9,52)/5/8(15,88)	3/8(9,52)/5/8(15,88)	3/8(9,52)/5/8(15,88)
Pipe length range / Elevation difference (in / out)		m / m	3-50/30	3-50/30	3-30/20	3-30/20	3-30/20
Pre-charged pipe length / Additional gas amount		m / g/m	10/50	10/50	10/50	10/50	10/50
Operating range - outdoor ambient	Heat	°C	-20~+35	-20~+35	-20~+35	-20~+35	-20~+35
	Cool	°C	+16~+43	+16~+43	+16~+43	+16~+43	+16~+43
Water outlet	Heat / Cool	°C	20-55/5-20	20-55/5-20	20-55/5-20	20-55/5-20	20-55/5-20

1) Scale from A+++ to D. 2) Check local regulations. 3) Scale from A+ to F. 4) Sound power in accordance to 811/2013, 813/2013 and EN12102-1:2017 at +7 °C. * EER and COP calculation is based in accordance to EN14511. ** This product is designed to comply with the European Water Quality Directive 98/83/EC amended by 2015/1787/EU. The lifespan of the product is not guaranteed in the case of the use of groundwater, such as spring water or well water, the use of tap water when salt or other impurities are contained, nor in areas of acidic water quality. Maintenance and warranty costs related to these cases are the customer's responsibility.

Accessories	
PAW-ADC-PREKIT-1	Piping pre installation kit for J Generation
CZ-TAW1B	Aquarea Smart Cloud for remote control and maintenance through wireless or wired LAN
CZ-TAW1-CBL	10 m extension cable for CZ-TAW1B

Accessories	
CZ-NS4P	Additional functions PCB
PAW-A2W-RTWIRED	Room thermostat
PAW-A2W-RTWIRELESS	Wireless LCD room thermostat



INTERNET CONTROL: Optional.

Aquarea High Performance All in One Compact J Generation Single phase. Heating and Cooling - R32

Energy efficiency: COP up to 5,33 / A+++ in heating at 35 °C and A+ in DHW / "A" water pump with variable speed / Stainless steel DHW tank with U-Vacua™ insulation panel / Built-in flow meter.

Flexibility: 598 x 600 footprint / Long piping lengths / Built-in magnetic water filter.

Comfort: Heating curve down to -20 °C / 60 °C water outlet temperature.

Control: Additional functions with optional PCB (2 zone control, bivalent control, Smart Grid contact and more).

Connectivity: Optional Aquarea Smart and Service Cloud and integration into BMS projects.

011-1W0207
011-1W0208
011-1W0209



3, 5 and
7 kW
models.

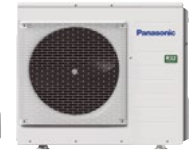

		Single phase [power to indoor]				
Kit		KIT-ADC03JE5C	KIT-ADC05JE5C	KIT-ADC07JE5C	KIT-ADC09JE5C-1	
Heating capacity / COP (A +7 °C, W 35 °C)	kW / COP	3,20/5,33	5,00/5,00	7,00/4,76	9,00/4,48	
Heating capacity / COP (A +7 °C, W 55 °C)	kW / COP	3,20/2,81	5,00/2,72	7,00/2,82	8,95/2,78	
Heating capacity / COP (A +2 °C, W 35 °C)	kW / COP	3,20/3,64	4,20/3,18	6,85/3,41	7,00/3,40	
Heating capacity / COP (A +2 °C, W 55 °C)	kW / COP	3,20/2,19	4,10/1,99	6,20/2,21	6,30/2,16	
Heating capacity / COP (A -7 °C, W 35 °C)	kW / COP	3,30/2,80	4,20/2,59	5,60/2,87	6,12/2,78	
Heating capacity / COP (A -7 °C, W 55 °C)	kW / COP	3,20/1,79	3,55/1,71	5,25/1,94	5,90/1,93	
Cooling capacity / EER (A 35 °C, W 7 °C)	kW / EER	3,20/3,52	4,50/3,00	6,70/3,03	8,20/2,72	
Cooling capacity / EER (A 35 °C, W 18 °C)	kW / EER	3,20/4,71	4,80/4,29	6,70/4,72	9,00/4,18	
Heating average climate (W 35 °C / W 55 °C)	Seasonal energy efficiency	SCOP (η _s %)	5,07/3,47(200/136)	5,07/3,47(200/136)	4,90/3,32(193/130)	4,90/3,32(193/130)
	Energy class ¹⁾		A+++ / A++	A+++ / A++	A+++ / A++	A+++ / A++
Heating warm climate (W 35 °C / W 55 °C)	Seasonal energy efficiency	SCOP (η _s %)	6,20/4,20(245/165)	6,20/4,20(245/165)	5,75/4,07(227/160)	5,75/4,07(227/160)
	Energy class ¹⁾		A+++ / A+++	A+++ / A+++	A+++ / A+++	A+++ / A+++
Heating cold climate (W 35 °C / W 55 °C)	Seasonal energy efficiency	SCOP (η _s %)	4,00/2,83(157/110)	4,00/2,83(157/110)	4,18/2,98(164/116)	4,18/2,98(164/116)
	Energy class ¹⁾		A++ / A+	A++ / A+	A++ / A+	A++ / A+
Indoor unit		WH-ADC0309J3E5C	WH-ADC0309J3E5C	WH-ADC0309J3E5C	WH-ADC0309J3E5C	
Sound pressure	Heat / Cool	dB(A)	28/28	28/28	28/28	
Dimension	H x W x D	mm	1642 x 599 x 602	1642 x 599 x 602	1642 x 599 x 602	
Net weight		kg	101	101	101	
Water pipe connector		Inch	R 1½	R 1½	R 1½	
A class pump	Number of speeds		Variable Speed	Variable Speed	Variable Speed	
	Input power (Min/Max)	W	30/120	30/120	30/120	
Heating water flow (ΔT=5 K, 35 °C)		L/min	9,20	14,30	20,10	
Electric backup heater		kW	3,00	3,00	3,00	
Recommended fuse		A	16/16	16/16	25/16	
Recommended minimum cable size, supply 1 / 2 ²⁾		mm ²	3 x 1,5 / 3 x 1,5	3 x 1,5 / 3 x 1,5	3 x 2,5 / 3 x 1,5	
Water volume		L	185	185	185	
Maximum DHW temperature		°C	65	65	65	
Material inside tank			Stainless steel	Stainless steel	Stainless steel	
Tapping profile according EN16147			L	L	L	
DHW tank ERP efficiency average / warm / cold ³⁾		A+ to F	A+ / A+ / A	A+ / A+ / A	A+ / A+ / A	
DHW tank ERP average climate η / COPdHW		η _{wh} % / COPdHW	128/3,20	128/3,20	116/2,90	
DHW tank ERP warm climate η / COPdHW		η _{wh} % / COPdHW	154/3,86	154/3,86	134/3,35	
DHW tank ERP cold climate η / COPdHW		η _{wh} % / COPdHW	99/2,48	99/2,48	98/2,45	
Outdoor unit		WH-UD03JE5	WH-UD05JE5	WH-UD07JE5	WH-UD09JE5-1	
Sound power ⁴⁾	Heat	dB(A)	55	55	59	
Dimension / Net weight	H x W x D	mm / kg	622 x 824 x 298 / 37	622 x 824 x 298 / 37	795 x 875 x 320 / 61	
Refrigerant (R32) / CO ₂ Eq.		kg / T	0,9/0,608	0,9/0,608	1,27/0,857	
Piping diameter	Liquid / Gas	Inch (mm)	1/4(6,35)/1/2(12,70)	1/4(6,35)/1/2(12,70)	1/4(6,35)/5/8(15,88)	
Pipe length range / Elevation difference (in / out)		m / m	3~25/20	3~25/20	3~50/30	
Pre-charged pipe length / Additional gas amount		m / g/m	10/20	10/20	10/25	
Operating range - outdoor ambient	Heat	°C	-20~+35	-20~+35	-20~+35	
	Cool	°C	+10~+43	+10~+43	+10~+43	
Water outlet	Heat / Cool	°C	20~60/5~20	20~60/5~20	20~60/5~20	

1) Scale from A+++ to D. 2) Check local regulations. 3) Scale from A+ to F. 4) Sound power in accordance to 811/2013, 813/2013 and EN12102-1:2017 at +7 °C. * EER and COP calculation is based in accordance to EN14511. ** This product is designed to comply with the European Water Quality Directive 98/83/EC amended by 2015/1787/EU. The lifespan of the product is not guaranteed in the case of the use of groundwater, such as spring water or well water, the use of tap water when salt or other impurities are contained, nor in areas of acidic water quality. Maintenance and warranty costs related to these cases are the customer's responsibility.

Accessories	
CZ-TAW1B	Aquarea Smart Cloud for remote control and maintenance through wireless or wired LAN
CZ-TAW1-CBL	10 m extension cable for CZ-TAW1B

Accessories	
CZ-NS4P	Additional functions PCB
PAW-A2W-RTWIRED	Room thermostat
PAW-A2W-RTWIRELESS	Wireless LCD room thermostat



INTERNET CONTROL: Optional.

Aquarea High Performance All in One Compact H Generation Single phase. Heating and Cooling · R410A

Energy efficiency: A+++ in heating at 35 °C and A in DHW / "A" water pump with variable speed / Stainless steel DHW tank with U-Vacua™ insulation panel / Built-in flow meter.

Flexibility: 598 x 600 footprint / Built-in magnetic water filter.

Comfort: Operating range down to -20 °C.

Control: Additional functions with optional PCB (2 zone control, bivalent control, Smart Grid contact and more).

Connectivity: Optional Aquarea Smart and Service Cloud and integration into BMS projects.



Single phase (power to indoor)

Kit		KIT-ADC12HE5C		KIT-ADC16HE5C	
Heating capacity / COP (A +7 °C, W 35 °C)	kW / COP	12,00/4,74	16,00/4,28		
Heating capacity / COP (A +7 °C, W 55 °C)	kW / COP	12,00/2,93	14,50/2,72		
Heating capacity / COP (A +2 °C, W 35 °C)	kW / COP	11,40/3,44	13,00/3,28		
Heating capacity / COP (A +2 °C, W 55 °C)	kW / COP	9,10/2,20	9,80/2,17		
Heating capacity / COP (A -7 °C, W 35 °C)	kW / COP	10,00/2,73	11,40/2,57		
Heating capacity / COP (A -7 °C, W 55 °C)	kW / COP	8,20/1,92	9,00/1,82		
Cooling capacity / EER (A 35 °C, W 7 °C)	kW / EER	10,00/2,81	12,20/2,56		
Cooling capacity / EER (A 35 °C, W 18 °C)	kW / EER	10,00/4,17	12,20/4,12		
Heating average climate (W 35 °C / W 55 °C)	Seasonal energy efficiency	SCOP (η _s %)	4,82/3,42(190/134)	4,82/3,33(190/130)	
	Energy class ¹⁾	A+++ to D	A+++/A++	A+++/A++	
Heating warm climate (W 35 °C / W 55 °C)	Seasonal energy efficiency	SCOP (η _s %)	6,21/4,05(245/159)	6,20/4,30(245/169)	
	Energy class ¹⁾	A+++ to D	A+++/A+++	A+++/A+++	
Heating cold climate (W 35 °C / W 55 °C)	Seasonal energy efficiency	SCOP (η _s %)	4,29/3,10(168/121)	4,28/3,10(168/121)	
	Energy class ¹⁾	A+++ to D	A++/A+	A++/A+	
Indoor unit		WH-ADC1216H6E5C		WH-ADC1216H6E5C	
Sound pressure	Heat / Cool	dB(A)	33/33	33/33	
Dimension	HxWxD	mm	1642x599x602	1642x599x602	
Net weight		kg	101	101	
Water pipe connector		Inch	R 1½	R 1½	
A class pump	Number of speeds		Variable Speed	Variable Speed	
	Input power (Min/Max)	W	—/—	—/—	
Heating water flow (ΔT=5 K, 35 °C)		L/min	34,40	45,90	
Electric backup heater		kW	6,00	6,00	
Recommended fuse		A	—/—	—/—	
Recommended minimum cable size, supply 1 / 2 ²⁾		mm ²	—/—	—/—	
Water volume		L	185	185	
Maximum DHW temperature		°C	65	65	
Material inside tank			Stainless steel	Stainless steel	
Tapping profile according EN16147			—	—	
DHW tank ERP efficiency average / warm / cold ³⁾		A+ to F	—/—/—	—/—/—	
DHW tank ERP average climate η / COPdHW		η _{wh} %/COPdHW	92/2,30	88/2,20	
DHW tank ERP warm climate η / COPdHW		η _{wh} %/COPdHW	107/2,67	104/2,59	
DHW tank ERP cold climate η / COPdHW		η _{wh} %/COPdHW	72/1,81	70/1,74	
Outdoor unit		WH-UD12HE5		WH-UD16HE5	
Sound power ⁴⁾	Heat	dB(A)	65	65	
Dimension / Net weight	HxWxD	mm / kg	1340x900x320/101	1340x900x320/101	
Refrigerant (R410A) / CO ₂ Eq.		kg / T	2,55/5,324	2,55/5,324	
Piping diameter	Liquid / Gas	Inch (mm)	3/8(9,52)/5/8(15,88)	3/8(9,52)/5/8(15,88)	
Pipe length range / Elevation difference (in / out)		m / m	3-50/30	3-50/30	
Pre-charged pipe length / Additional gas amount		m / g/m	10/50	10/50	
Operating range - outdoor ambient	Heat	°C	-20 ~ +35	-20 ~ +35	
	Cool	°C	+16 ~ +43	+16 ~ +43	
Water outlet	Heat / Cool	°C	20-55/5-20	20-55/5-20	

1) Scale from A+++ to D. 2) Check local regulations. 3) Scale from A+ to F. 4) Sound power in accordance to 811/2013, 813/2013 and EN12102-1:2017 at +7 °C. * EER and COP calculation is based in accordance to EN14511. ** This product is designed to comply with the European Water Quality Directive 98/83/EC amended by 2015/1787/EU. The lifespan of the product is not guaranteed in the case of the use of groundwater, such as spring water or well water, the use of tap water when salt or other impurities are contained, nor in areas of acidic water quality. Maintenance and warranty costs related to these cases are the customer's responsibility.

Accessories	
CZ-TAW1B	Aquarea Smart Cloud for remote control and maintenance through wireless or wired LAN
CZ-TAW1-CBL	10 m extension cable for CZ-TAW1B

Accessories	
CZ-NS4P	Additional functions PCB
PAW-A2W-RTWIRED	Room thermostat
PAW-A2W-RTWIRELESS	Wireless LCD room thermostat



INTERNET CONTROL: Optional.

NEW Aquarea High Performance Bi-bloc K Generation Single phase. Heating and Cooling - SDC · R32

Energy efficiency: COP up to 5,33 / A+++ in heating at 35 °C / "A" water pump with variable speed / Built-in flow meter.

Flexibility: Long piping lengths / Built-in magnetic water filter.

Comfort: Operation without backup heating at -25 °C / 60 °C hot water even at -10 °C outside temperature.

Control: Optimised user interface and improved features [2 zone control, bivalent control].

Connectivity: Optional Aquarea Smart and Service Cloud and integration into BMS projects.



Tentative data

		Single phase [power to indoor]						
Kit 3 kW electric heater		KIT-WC03K3E5	KIT-WC05K3E5	KIT-WC07K3E5	KIT-WC09K3E5			
Kit 6 kW electric heater		KIT-WC03K6E5	KIT-WC05K6E5	KIT-WC07K6E5	KIT-WC09K6E5			
Heating capacity / COP (A +7 °C, W 35 °C)	kW / COP	3,20/5,33	5,00/5,10	7,00/4,86	9,00/4,55			
Heating capacity / COP (A +7 °C, W 55 °C)	kW / COP	3,20/2,81	5,00/3,03	7,00/2,92	8,90/2,93			
Heating capacity / COP (A +2 °C, W 35 °C)	kW / COP	3,20/3,64	5,00/3,57	6,85/3,43	7,00/3,40			
Heating capacity / COP (A +2 °C, W 55 °C)	kW / COP	3,20/2,19	5,00/2,29	6,25/2,23	6,30/2,18			
Heating capacity / COP (A -7 °C, W 35 °C)	kW / COP	3,30/2,80	5,00/2,79	5,75/2,95	6,25/2,84			
Heating capacity / COP (A -7 °C, W 55 °C)	kW / COP	3,20/1,79	5,00/1,89	5,35/1,98	5,90/1,93			
Cooling capacity / EER (A 35 °C, W 7 °C)	kW / EER	3,20/3,52	5,00/3,05	6,70/3,03	8,20/2,72			
Cooling capacity / EER (A 35 °C, W 18 °C)	kW / EER	3,20/4,71	5,00/4,90	6,70/4,72	9,00/4,18			
Heating average climate (W 35 °C / W 55 °C)	Seasonal energy efficiency	SCOP (η _s %)	5,07/3,47 (200/136)	5,12/3,63 (202/142)	4,90/3,62 (193/142)	4,44/3,41 (175/133)		
	Energy class ¹⁾		A+++ / A++	A+++ / A++	A+++ / A++	A+++ / A++		
Heating warm climate (W 35 °C / W 55 °C)	Seasonal energy efficiency	SCOP (η _s %)	6,20/4,20 (245/165)	6,00/4,20 (237/165)	5,75/4,07 (227/160)	5,75/4,07 (227/160)		
	Energy class ¹⁾		A+++ / A+++	A+++ / A+++	A+++ / A+++	A+++ / A+++		
Heating cold climate (W 35 °C / W 55 °C)	Seasonal energy efficiency	SCOP (η _s %)	4,00/2,83 (157/110)	4,08/2,95 (160/115)	4,18/2,98 (164/116)	4,18/2,98 (164/116)		
	Energy class ¹⁾		A++ / A+	A++ / A+	A++ / A+	A++ / A+		
Indoor unit 3 kW electric heater		WH-SDC0309K3E5	WH-SDC0309K3E5	WH-SDC0309K3E5	WH-SDC0309K3E5			
Indoor unit 6 kW electric heater		WH-SDC0309K6E5	WH-SDC0309K6E5	WH-SDC0309K6E5	WH-SDC0309K6E5			
Sound pressure	Heat / Cool	dB(A)	28/28	28/28	30/30	30/31		
Dimension	H x W x D	mm	892 x 500 x 348	892 x 500 x 348	892 x 500 x 348	892 x 500 x 348		
Net weight		kg	—	—	—	—		
Water pipe connector		Inch	R 1 1/4	R 1 1/4	R 1 1/4	R 1 1/4		
A class pump	Number of speeds		Variable Speed	Variable Speed	Variable Speed	Variable Speed		
	Input power (Min/Max)	W	30/120	30/120	30/120	30/120		
Heating water flow (ΔT=5 K, 35 °C)		L/min	9,2	14,3	20,1	25,8		
Outdoor unit		WH-UDZ03KE5	WH-UDZ05KE5	WH-UDZ07KE5	WH-UDZ09KE5			
Sound power ²⁾	Heat	dB(A)	55	55	56	56		
Dimension	H x W x D	mm	622 x 824 x 298	795 x 875 x 320	795 x 875 x 320	795 x 875 x 320		
Net weight		kg	37	55	55	55		
Refrigerant (R32) / CO ₂ Eq.		kg / T	0,9/0,608	1,3/0,878	1,3/0,878	1,3/0,878		
Piping diameter	Liquid / Gas	Inch (mm)	1/4 (6,35) / 1/2 (12,70)	1/4 (6,35) / 5/8 (15,88)	1/4 (6,35) / 5/8 (15,88)	1/4 (6,35) / 5/8 (15,88)		
Pipe length range		m	3 ~ 25	3 ~ 40 [3 ~ 50] ³⁾	3 ~ 40 [3 ~ 50] ³⁾	3 ~ 40 [3 ~ 50] ³⁾		
Elevation difference (in / out)		m	20	30	30	30		
Pre-charged pipe length		m	10	10	10	10		
Additional gas amount		g/m	20	25	25	25		
Operating range - outdoor ambient	Heat	°C	-20 ~ +35	-25 ~ +35	-25 ~ +35	-25 ~ +35		
	Cool	°C	+10 ~ +43	+10 ~ +43	+10 ~ +43	+10 ~ +43		
Water outlet	Heat / Cool	°C	20 ~ 60 / 5 ~ 20	20 ~ 60 / 5 ~ 20	20 ~ 60 / 5 ~ 20	20 ~ 60 / 5 ~ 20		
Electrical information			3 kW heater	6 kW heater	3 kW heater	6 kW heater	3 kW heater	6 kW heater
Electric backup heater		kW	3,00	6,00	3,00	6,00	3,00	6,00
Recommended fuse		A	16/16	16/30	16/16	16/30	25/16	25/30
Recommended minimum cable size, supply 1 / 2 ⁴⁾		mm ²	3x1,5/3x1,5	3x1,5/3x4,0	3x1,5/3x1,5	3x1,5/3x4,0	3x2,5/3x1,5	3x2,5/3x4,0

1) Scale from A+++ to D. 2) Sound power in accordance to 811/2013, 813/2013 and EN12102-1:2017 at +7 °C. 3) Operation range down to -25 °C in heating with 3-40 m pipe length range, operation range down to -15 °C in heating with 3-50 m pipe length range. 4) Check local regulations. * EER and COP calculation is based in accordance to EN14511. ** This product is designed to comply with the European Water Quality Directive 98/83/EC amended by 2015/1787/EU. The lifespan of the product is not guaranteed in the case of the use of groundwater, such as spring water or well water, the use of tap water when salt or other impurities are contained, nor in areas of acidic water quality. Maintenance and warranty costs related to these cases are the customer's responsibility. *** Available Autumn 23.

Accessories	
CZ-RTW1	Additional remote controller for K and L Generations
PAW-TD20C1E5-1	Tank 200 L - Stainless steel
PAW-TD30C1E5-1	Tank 300 L - Stainless steel
PAW-TA20C1E5STD	Tank 200 L - Enamelled
PAW-TA30C1E5STD	Tank 300 L - Enamelled
PAW-3WVYLV-HW	3 way valve for DHW tanks
CZ-NV2	3 way valve kit for inside of hydrokit for K and L Generations

Accessories	
PAW-BTANK50L-2	Buffer tank 50 L
CZ-TAW1B	Aquarea Smart Cloud for remote control and maintenance through wireless or wired LAN
CZ-TAW1-CBL	10 m extension cable for CZ-TAW1B
CZ-NS5P	Additional functions PCB
PAW-A2W-RTWIRED	Room thermostat
PAW-A2W-RTWIREDLESS	Wireless LCD room thermostat



INTERNET CONTROL: Optional.

Aquarea High Performance Bi-bloc J Generation Single phase. Heating and Cooling - SDC · R32

Energy efficiency: COP up to 5,33 / A+++ in heating at 35 °C / "A" water pump with variable speed / Built-in flow meter.

Flexibility: Long piping lengths / Built-in magnetic water filter.

Comfort: Operating range and heating curve down to -20 °C / 60 °C water outlet temperature.

Control: Additional functions with optional PCB (2 zone control, bivalent control, Smart Grid contact and more).

Connectivity: Optional Aquarea Smart and Service Cloud and integration into BMS projects.



011-1W0207
011-1W0208
011-1W0209



3, 5 and
7 kW
models.



ErP 55 °C
Scale from
A+++ to D



ErP 35 °C
Scale from
A+++ to D



Kit		Single phase (power to indoor)				
		KIT-WC03J3E5	KIT-WC05J3E5	KIT-WC07J3E5	KIT-WC09J3E5	
Heating capacity / COP (A +7 °C, W 35 °C)	kW / COP	3,20/5,33	5,00/5,00	7,00/4,76	9,00/4,48	
Heating capacity / COP (A +7 °C, W 55 °C)	kW / COP	3,20/2,81	5,00/2,72	7,00/2,82	8,95/2,78	
Heating capacity / COP (A +2 °C, W 35 °C)	kW / COP	3,20/3,64	4,20/3,18	6,85/3,41	7,00/3,40	
Heating capacity / COP (A +2 °C, W 55 °C)	kW / COP	3,20/2,19	4,10/1,99	6,20/2,21	6,30/2,16	
Heating capacity / COP (A -7 °C, W 35 °C)	kW / COP	3,30/2,80	4,20/2,59	5,60/2,87	6,12/2,78	
Heating capacity / COP (A -7 °C, W 55 °C)	kW / COP	3,20/1,79	3,55/1,71	5,25/1,94	5,90/1,93	
Cooling capacity / EER (A 35 °C, W 7 °C)	kW / EER	3,20/3,52	4,50/3,00	6,70/3,03	8,20/2,72	
Cooling capacity / EER (A 35 °C, W 18 °C)	kW / EER	3,20/4,71	4,80/4,29	6,70/4,72	9,00/4,18	
Heating average climate (W 35 °C / W 55 °C)	Seasonal energy efficiency	SCOP (η _s %)	5,07/3,47(200/136)	5,07/3,47(200/136)	4,90/3,32(193/130)	4,90/3,32(193/130)
	Energy class	A+++ to D	A+++/A++	A+++/A++	A+++/A++	A+++/A++
Heating warm climate (W 35 °C / W 55 °C)	Seasonal energy efficiency	SCOP (η _s %)	6,20/4,20(245/165)	6,20/4,20(245/165)	5,75/4,07(227/160)	5,75/4,07(227/160)
	Energy class	A+++ to D	A+++/A+++	A+++/A+++	A+++/A+++	A+++/A+++
Heating cold climate (W 35 °C / W 55 °C)	Seasonal energy efficiency	SCOP (η _s %)	4,00/2,83(157/110)	4,00/2,83(157/110)	4,18/2,98(164/116)	4,18/2,98(164/116)
	Energy class	A+++ to D	A++/A+	A++/A+	A++/A+	A++/A+
Indoor unit		WH-SDC0305J3E5	WH-SDC0305J3E5	WH-SDC0709J3E5	WH-SDC0709J3E5	
Sound pressure	Heat / Cool	dB(A)	28/28	28/28	30/30	30/31
Dimension	H x W x D	mm	892 x 500 x 340	892 x 500 x 340	892 x 500 x 340	892 x 500 x 340
Net weight		kg	42	42	42	42
Water pipe connector		Inch	R 1½	R 1½	R 1½	R 1½
A class pump	Number of speeds		Variable Speed	Variable Speed	Variable Speed	Variable Speed
	Input power (Min/Max)	W	30/100	33/106	34/114	40/120
Heating water flow (ΔT=5 K, 35 °C)		L/min	9,2	14,3	20,1	25,8
Electric backup heater		kW	3,00	3,00	3,00	3,00
Recommended fuse		A	15/30	15/30	15/30	15/30
Recommended minimum cable size, supply 1 / 2 ¹⁾		mm ²	3 x 1,5/3 x 1,5	3 x 1,5/3 x 1,5	3 x 2,5/3 x 1,5	3 x 2,5/3 x 1,5
Outdoor unit		WH-UD03JE5	WH-UD05JE5	WH-UD07JE5	WH-UD09JE5-1	
Sound power ²⁾	Heat	dB(A)	55	55	59	59
Dimension	H x W x D	mm	622 x 824 x 298	622 x 824 x 298	795 x 875 x 320	795 x 875 x 320
Net weight		kg	37	37	61	61
Refrigerant (R32) / CO ₂ Eq.		kg / T	0,9/0,608	0,9/0,608	1,27/0,857	1,27/0,857
Piping diameter	Liquid / Gas	Inch (mm)	1/4(6,35)/1/2(12,70)	1/4(6,35)/1/2(12,70)	1/4(6,35)/5/8(15,88)	1/4(6,35)/5/8(15,88)
Pipe length range		m	3-25	3-25	3-50	3-50
Elevation difference (in / out)		m	20	20	30	30
Pre-charged pipe length		m	10	10	10	10
Additional gas amount		g/m	20	20	25	25
Operating range - outdoor ambient	Heat	°C	-20 ~ +35	-20 ~ +35	-20 ~ +35	-20 ~ +35
	Cool	°C	+10 ~ +43	+10 ~ +43	+10 ~ +43	+10 ~ +43
Water outlet	Heat / Cool	°C	20 ~ 60/5 ~ 20	20 ~ 60/5 ~ 20	20 ~ 60/5 ~ 20	20 ~ 60/5 ~ 20

1) Check local regulations. 2) Sound power in accordance to 811/2013, 813/2013 and EN12102-1:2017 at +7 °C. * EER and COP calculation is based in accordance to EN14511.

Accessories	
PAW-TD20C1E5-1	Tank 200 L - Stainless steel
PAW-TD30C1E5-1	Tank 300 L - Stainless steel
PAW-TA20C1E5STD	Tank 200 L - Enamelled
PAW-TA30C1E5STD	Tank 300 L - Enamelled
PAW-3WYVLV-HW	3 way valve for DHW tanks
CZ-NV1	3 way valve kit for inside of hydrokit for H and J Generations

Accessories	
PAW-BTANK50L-2	Buffer tank 50 L
CZ-TAW1B	Aquarea Smart Cloud for remote control and maintenance through wireless or wired LAN
CZ-TAW1-CBL	10 m extension cable for CZ-TAW1B
CZ-NS4P	Additional functions PCB
PAW-A2W-RTWIRED	Room thermostat
PAW-A2W-RTWIRELESS	Wireless LCD room thermostat



INTERNET CONTROL: Optional.

Aquarea High Performance Bi-bloc H Generation Single phase / Three phase. Heating and Cooling - SDC · R410A

Energy efficiency: A+++ in heating at 35 °C / "A" water pump with variable speed / Built-in flow meter.

Flexibility: Optional magnet for the water filter.

Comfort: Operating range down to -20 °C.

Control: Additional functions with optional PCB (2 zone control, bivalent control, Smart Grid contact and more).

Connectivity: Optional Aquarea Smart and Service Cloud and integration into BMS projects.



011-1W0515

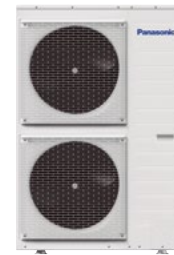

Kit	Single phase			Three phase (power to indoor)			
	KIT-WC12H6E5	KIT-WC16H6E5	KIT-WC09H3E8	KIT-WC12H9E8	KIT-WC16H9E8		
Heating capacity / COP (A +7 °C, W 35 °C)	kW / COP	12,00/4,74	16,00/4,28	9,00/4,84	12,00/4,74	16,00/4,28	
Heating capacity / COP (A +7 °C, W 55 °C)	kW / COP	12,00/2,88	14,50/2,68	9,00/2,94	12,00/2,88	14,50/2,68	
Heating capacity / COP (A +2 °C, W 35 °C)	kW / COP	11,40/3,44	13,00/3,28	9,00/3,59	11,40/3,44	13,00/3,28	
Heating capacity / COP (A +2 °C, W 55 °C)	kW / COP	9,10/2,20	9,80/2,17	8,80/2,23	9,10/2,20	9,80/2,17	
Heating capacity / COP (A -7 °C, W 35 °C)	kW / COP	10,00/2,73	11,40/2,57	9,00/2,85	10,00/2,73	11,40/2,57	
Heating capacity / COP (A -7 °C, W 55 °C)	kW / COP	8,20/1,92	9,00/1,82	7,90/2,05	8,20/1,92	9,00/1,82	
Cooling capacity / EER (A 35 °C, W 7 °C)	kW / EER	10,00/2,81	12,20/2,56	7,00/3,14	10,00/3,91	12,20/2,56	
Cooling capacity / EER (A 35 °C, W 18 °C)	kW / EER	10,00/4,17	12,20/4,12	7,00/4,61	10,00/4,17	12,20/4,12	
Heating average climate (W 35 °C / W 55 °C)	Seasonal energy efficiency	SCOP (η _s , %)	4,82/3,42(190/134)	4,82/3,33(190/130)	4,81/3,41(190/133)	4,82/3,42(190/134)	4,82/3,33(190/130)
	Energy class		A+++ / A++	A+++ / A++	A+++ / A++	A+++ / A++	A+++ / A++
Heating warm climate (W 35 °C / W 55 °C)	Seasonal energy efficiency	SCOP (η _s , %)	6,21/4,05(245/159)	6,21/4,30(245/169)	6,21/4,05(245/159)	6,21/4,05(245/159)	6,20/4,30(245/169)
	Energy class		A+++ / A+++	A+++ / A+++	A+++ / A+++	A+++ / A+++	A+++ / A+++
Heating cold climate (W 35 °C / W 55 °C)	Seasonal energy efficiency	SCOP (η _s , %)	4,29/3,10(168/121)	4,28/3,10(168/121)	4,28/3,10(168/121)	4,29/3,10(168/121)	4,28/3,10(168/121)
	Energy class		A++ / A+	A++ / A+	A++ / A+	A++ / A+	A++ / A+
Indoor unit			WH-SDC12H6E5	WH-SDC16H6E5	WH-SDC09H3E8	WH-SDC12H9E8	WH-SDC16H9E8
Sound pressure	Heat / Cool	dB(A)	33/33	33/33	33/33	33/33	33/33
Dimension	HxWxD	mm	892x500x340	892x500x340	892x500x340	892x500x340	892x500x340
Net weight		kg	43	44	43	44	45
Water pipe connector		Inch	R 1½	R 1½	R 1½	R 1½	R 1½
A class pump	Number of speeds		Variable Speed	Variable Speed	Variable Speed	Variable Speed	Variable Speed
	Input power (Min/Max)	W	34/110	30/105	32/102	34/110	30/105
Heating water flow (ΔT=5 K, 35 °C)		L/min	34,4	45,9	25,8	34,4	45,9
Electric backup heater		kW	6,00	6,00	3,00	9,00	9,00
Recommended fuse		A	30/30	30/30	15/30	15/30	15/30
Recommended minimum cable size, supply 1 / 2 ¹⁾		mm ²	3x4,0or6,0/3x4,0	3x4,0or6,0/3x4,0	5x1,5/5x1,5	5x1,5/5x1,5	5x1,5/5x1,5
Outdoor unit			WH-UD12HE5	WH-UD16HE5	WH-UD09HE8	WH-UD12HE8	WH-UD16HE8
Sound power ²⁾	Heat	dB(A)	65	65	65	65	65
Dimension	HxWxD	mm	1340x900x320	1340x900x320	1340x900x320	1340x900x320	1340x900x320
Net weight		kg	101	101	107	107	107
Refrigerant (R410A) / CO ₂ Eq.		kg / T	2,55/5,324	2,55/5,324	2,55/5,324	2,55/5,324	2,55/5,324
Piping diameter	Liquid / Gas	Inch (mm)	3/8(9,52)/5/8(15,88)	3/8(9,52)/5/8(15,88)	3/8(9,52)/5/8(15,88)	3/8(9,52)/5/8(15,88)	3/8(9,52)/5/8(15,88)
Pipe length range		m	3-50	3-50	3-30	3-30	3-30
Elevation difference (in / out)		m	30	30	20	20	20
Pre-charged pipe length		m	10	10	10	10	10
Additional gas amount		g/m	50	50	50	50	50
Operating range - outdoor ambient	Heat	°C	-20 ~ +35	-20 ~ +35	-20 ~ +35	-20 ~ +35	-20 ~ +35
	Cool	°C	+16 ~ +43	+16 ~ +43	+16 ~ +43	+16 ~ +43	+16 ~ +43
Water outlet	Heat / Cool	°C	20-55/5-20	20-55/5-20	20-55/5-20	20-55/5-20	20-55/5-20

1) Check local regulations. 2) Sound power in accordance to 811/2013, 813/2013 and EN12102-1:2017 at +7 °C. * EER and COP calculation is based in accordance to EN14511.

Accessories

PAW-TD20C1E5-1	Tank 200 L - Stainless steel
PAW-TD30C1E5-1	Tank 300 L - Stainless steel
PAW-TA20C1E5STD	Tank 200 L - Enamelled
PAW-TA30C1E5STD	Tank 300 L - Enamelled
PAW-3WYVLV-HW	3 way valve for DHW tanks
CZ-NV1	3 way valve kit for inside of hydrokit for H and J Generations
PAW-BTANK50L-2	Buffer tank 50 L

Accessories

CZ-TAW1B	Aquarea Smart Cloud for remote control and maintenance through wireless or wired LAN
CZ-TAW1-CBL	10 m extension cable for CZ-TAW1B
CZ-NS4P	Additional functions PCB
PAW-A2W-MGTFILTER	Magnet for the water filter
PAW-A2W-RTWIRED	Room thermostat
PAW-A2W-RTWIRELESS	Wireless LCD room thermostat



INTERNET CONTROL: Optional.

Aquarea High Performance Mono-bloc J Generation Single phase. Heating and Cooling - MDC · R32

011-1W0398
011-1W0399
011-1W0400



Energy efficiency: A+++ in heating at 35 °C / "A" water pump with variable speed / Built-in flow meter.

Flexibility: Built-in magnetic water filter / Built-in 6L expansion vessel.

Comfort: Operating range and heating curve down to -20 °C / 60 °C water outlet temperature / Cooling mode down to +10 °C.

Control: Additional functions with optional PCB (2 zone control, bivalent control, Smart Grid contact and more).

Connectivity: Optional Aquarea Smart and Service Cloud and integration into BMS projects.



Outdoor unit		Single phase			
		WH-MDC05J3E5	WH-MDC07J3E5	WH-MDC09J3E5	
Heating capacity / COP (A +7 °C, W 35 °C)	kW / COP	5,00/5,08	7,00/4,76	9,00/4,48	
Heating capacity / COP (A +7 °C, W 55 °C)	kW / COP	5,00/3,01	7,00/2,82	8,95/2,78	
Heating capacity / COP (A +2 °C, W 35 °C)	kW / COP	5,00/3,57	7,00/3,40	7,45/3,13	
Heating capacity / COP (A +2 °C, W 55 °C)	kW / COP	5,00/2,27	6,30/2,16	7,00/2,12	
Heating capacity / COP (A -7 °C, W 35 °C)	kW / COP	5,00/2,78	6,80/2,81	7,50/2,63	
Heating capacity / COP (A -7 °C, W 55 °C)	kW / COP	5,00/1,85	6,30/1,86	7,00/1,80	
Cooling capacity / EER (A 35 °C, W 7 °C)	kW / EER	5,00/3,31	7,00/3,06	9,00/2,71	
Cooling capacity / EER (A 35 °C, W 18 °C)	kW / EER	5,00/5,05	7,00/4,73	9,00/4,25	
Heating average climate (W 35 °C / W 55 °C)	Seasonal energy efficiency	SCOP (η _s %)	5,12/3,63(202/142)	4,90/3,32(193/130)	4,90/3,32(193/130)
	Energy class	A+++ to D	A+++/A++	A+++/A++	A+++/A++
Heating warm climate (W 35 °C / W 55 °C)	Seasonal energy efficiency	SCOP (η _s %)	6,00/4,20(237/165)	5,75/4,07(227/160)	5,75/4,07(227/160)
	Energy class	A+++ to D	A+++/A+++	A+++/A+++	A+++/A+++
Heating cold climate (W 35 °C / W 55 °C)	Seasonal energy efficiency	SCOP (η _s %)	4,08/2,95(160/115)	4,18/2,98(164/116)	4,18/2,98(164/116)
	Energy class	A+++ to D	A++/A+	A++/A+	A++/A+
Sound power ¹⁾	Heat	dB(A)	59	59	59
Dimension	HxWxD	mm	865 x 1283 x 320	865 x 1283 x 320	865 x 1283 x 320
Net weight		kg	99	104	104
Refrigerant (R32) / CO ₂ Eq. ²⁾		kg / T	1,3/0,878	1,3/0,878	1,3/0,878
Water pipe connector		Inch	R 1½	R 1½	R 1½
Pump	Number of speeds		Variable Speed	Variable Speed	Variable Speed
	Input power (Min/Max)	W	34/96	36/100	39/108
Heating water flow (ΔT=5 K, 35 °C)		L/min	14,3	20,1	25,8
Electric backup heater		kW	3,00	3,00	3,00
Input power	Heat	kW	0,985	1,47	2,01
	Cool	kW	1,51	2,29	3,32
Running and starting current	Heat	A	4,7	7,0	9,3
	Cool	A	7,0	10,5	14,7
Current 1		A	12	17	17
Current 2		A	13	13	13
Recommended fuse		A	30/15	30/15	30/16
Recommended minimum cable size, supply 1 / 2 ³⁾		mm ²	3x 1,5/3x 1,5	3x 2,5/3x 1,5	3x 2,5/3x 1,5
Operating range - outdoor ambient	Heat	°C	-20 ~ 35	-20 ~ 35	-20 ~ 35
	Cool	°C	+10 ~ +43	+10 ~ +43	+10 ~ +43
Water outlet	Heat	°C	20 ~ 60	20 ~ 60	20 ~ 60
	Cool	°C	5 ~ 20	5 ~ 20	5 ~ 20

1) Sound power in accordance to 811/2013, 813/2013 and EN12102-1:2017 at +7 °C. 2) WH-MDC models are hermetically sealed. 3) Check local regulations. * EER and COP calculation is based in accordance to EN14511.

Accessories	
PAW-TD20C1E5-1	Tank 200 L - Stainless steel
PAW-TD30C1E5-1	Tank 300 L - Stainless steel
PAW-TA20C1E5STD	Tank 200 L - Enamelled
PAW-TA30C1E5STD	Tank 300 L - Enamelled
PAW-TD20B8E3-2	Combo Tank 185 L + 80 L - Enamelled
PAW-TD23B6E5	Combo Tank 230 L + 60 L - Stainless Steel
PAW-3WYVLV-HW	3 way valve for DHW tanks
PAW-BTANK50L-2	Buffer tank 50 L

Accessories	
CZ-TAW1B	Aquarea Smart Cloud for remote control and maintenance through wireless or wired LAN
CZ-TAW1-CBL	10 m extension cable for CZ-TAW1B
PAW-A2W-AFVLV	1 anti-freeze valve. It is required to order 2 valves per system
PAW-A2W-RTWIRED	Room thermostat
PAW-A2W-RTWIRELESS	Wireless LCD room thermostat



INTERNET CONTROL: Optional.

Aquarea High Performance Mono-bloc H Generation Single phase. Heating and Cooling - MDC - R410A

Energy efficiency: A+++ in heating at 35 °C / "A" water pump with variable speed / Built-in flow meter.

Flexibility: Optional magnet for the water filter.

Comfort: Operating range and heating curve down to -20 °C / 55 °C water outlet temperature.

Control: Additional functions with optional PCB (2 zone control, bivalent control, Smart Grid contact and more).

Connectivity: Optional Aquarea Smart and Service Cloud and integration into BMS projects.

011-1W0509



ErP 55 °C
Scale from
A+++ to D



ErP 35 °C
Scale from
A+++ to D

Single phase

Outdoor unit			WH-MDC12H6E5	WH-MDC16H6E5
Heating capacity / COP (A +7 °C, W 35 °C)		kW / COP	12,00/4,74	16,00/4,28
Heating capacity / COP (A +7 °C, W 55 °C)		kW / COP	12,00/2,93	14,50/2,72
Heating capacity / COP (A +2 °C, W 35 °C)		kW / COP	11,40/3,44	13,00/3,28
Heating capacity / COP (A +2 °C, W 55 °C)		kW / COP	9,10/2,23	9,80/2,21
Heating capacity / COP (A -7 °C, W 35 °C)		kW / COP	10,00/2,73	11,40/2,57
Heating capacity / COP (A -7 °C, W 55 °C)		kW / COP	8,20/1,95	9,00/1,84
Cooling capacity / EER (A 35 °C, W 7 °C)		kW / EER	10,00/2,81	12,20/2,56
Cooling capacity / EER (A 35 °C, W 18 °C)		kW / EER	9,39/4,65	11,40/4,10
Heating average climate (W 35 °C / W 55 °C)	Seasonal energy efficiency	SCOP (η _s %)	4,82/3,42(190/134)	4,82/3,33(190/130)
	Energy class	A+++ to D	A+++/A++	A+++/A++
Heating warm climate (W 35 °C / W 55 °C)	Seasonal energy efficiency	SCOP (η _s %)	6,20/4,05(245/159)	6,20/4,30(245/169)
	Energy class	A+++ to D	A+++/A+++	A+++/A+++
Heating cold climate (W 35 °C / W 55 °C)	Seasonal energy efficiency	SCOP (η _s %)	4,28/3,10(168/121)	4,28/3,10(168/121)
	Energy class	A+++ to D	A++/A+	A++/A+
Sound power ¹⁾	Heat	dB(A)	65	65
Dimension	HxWxD	mm	1410x1283x320	1410x1283x320
Net weight		kg	140	140
Refrigerant (R410A) / CO ₂ Eq. ²⁾		kg / T	2,10/4,385	2,10/4,385
Water pipe connector		Inch	R 1½	R 1½
Pump	Number of speeds		Variable Speed	Variable Speed
	Input power (Min/Max)	W	34/110	38/120
Heating water flow (ΔT=5 K, 35 °C)		L/min	34,4	45,9
Electric backup heater		kW	6,00	6,00
Input power	Heat	kW	2,53	3,74
	Cool	kW	3,56	4,76
Running and starting current	Heat	A	11,7	16,9
	Cool	A	16,2	21,5
Current 1		A	24,0	26,0
Current 2		A	26,0	26,0
Recommended fuse		A	30/30	30/30
Recommended minimum cable size, supply 1 / 2 ³⁾		mm ²	3x4,0 or 6,0/3x4,0	3x4,0 or 6,0/3x4,0
Operating range - outdoor ambient	Heat	°C	-20 ~ +35	-20 ~ +35
	Cool	°C	+16 ~ +43	+16 ~ +43
Water outlet	Heat	°C	25 - 55	25 - 55
	Cool	°C	5 - 20	5 - 20

1) Sound power in accordance to 811/2013, 813/2013 and EN12102-1:2017 at +7 °C. 2) WH-MDC models are hermetically sealed. 3) Check local regulations. * EER and COP calculation is based in accordance to EN14511.

Accessories

PAW-TD20C1E5-1	Tank 200 L - Stainless steel
PAW-TD30C1E5-1	Tank 300 L - Stainless steel
PAW-TA20C1E5STD	Tank 200 L - Enamelled
PAW-TA30C1E5STD	Tank 300 L - Enamelled
PAW-TD20B8E3-2	Combo Tank 185 L + 80 L - Enamelled
PAW-TD23B6E5	Combo Tank 230 L + 60 L - Stainless Steel
PAW-3WYVLV-HW	3 way valve for DHW tanks
PAW-BTANK50L-2	Buffer tank 50 L

Accessories

CZ-TAW1B	Aquarea Smart Cloud for remote control and maintenance through wireless or wired LAN
CZ-TAW1-CBL	10 m extension cable for CZ-TAW1B
PAW-A2W-MGTFILTER	Magnet for the water filter
PAW-A2W-AFVLV	1 anti-freeze valve. It is required to order 2 valves per system
PAW-A2W-RTWIRED	Room thermostat
PAW-A2W-RTWIRELESS	Wireless LCD room thermostat



INTERNET CONTROL: Optional.

NEW Aquarea T-CAP All in One K Generation Single phase / Three phase. Heating and Cooling · R32

Energy efficiency: A+++ in heating at 35 °C and A+ in DHW / "A" water pump with variable speed / Stainless steel DHW tank with U-Vacua™ insulation panel / Built-in flow meter.

Flexibility: 598 x 600 footprint / Built-in magnetic water filter.

Comfort: Constant capacity down to -20 °C / Operating range down to -28 °C / 60 °C hot water even at -10 °C outside temperature.

Control: Optimised user interface and improved features (2 zone control, bivalent control).

Connectivity: Optional Aquarea Smart and Service Cloud and integration into BMS projects.



Kit	Single phase (power to indoor)		Three phase (power to indoor)			
	KIT-AXC09KE5	KIT-AXC12KE5	KIT-AXC09KE8	KIT-AXC12KE8		
Heating capacity / COP (A +7 °C, W 35 °C)	kW / COP	9,00/5,03	12,10/4,84	9,00/5,03	12,10/4,84	
Heating capacity / COP (A +7 °C, W 55 °C)	kW / COP	9,00/3,07	12,10/3,04	— / —	— / —	
Heating capacity / COP (A +2 °C, W 35 °C)	kW / COP	9,00/3,69	12,00/3,44	9,00/3,69	12,00/3,44	
Heating capacity / COP (A +2 °C, W 55 °C)	kW / COP	9,00/2,31	12,00/2,29	— / —	— / —	
Heating capacity / COP (A -7 °C, W 35 °C)	kW / COP	9,00/3,00	12,00/2,72	— / —	— / —	
Heating capacity / COP (A -7 °C, W 55 °C)	kW / COP	9,00/2,10	12,00/2,00	— / —	— / —	
Cooling capacity / EER (A 35 °C, W 7 °C)	kW / EER	8,80/3,11	10,70/2,68	8,80/3,11	10,70/2,68	
Cooling capacity / EER (A 35 °C, W 18 °C)	kW / EER	8,80/4,63	10,70/3,92	— / —	— / —	
Heating average climate (W 35 °C / W 55 °C)	Seasonal energy efficiency	SCOP (η _s %)	4,96/3,57(195/140)	4,96/3,57(195/140)	4,96/3,57(195/140)	4,96/3,57(195/140)
	Energy class ¹⁾	A+++ to D	A+++/A++	A+++/A++	A+++/A++	A+++/A++
Heating warm climate (W 35 °C / W 55 °C)	Seasonal energy efficiency	SCOP (η _s %)	6,47/4,34(256/171)	6,47/4,34(256/171)	6,47/4,34(256/171)	6,47/4,34(256/171)
	Energy class ¹⁾	A+++ to D	A+++/A+++	A+++/A+++	A+++/A+++	A+++/A+++
Heating cold climate (W 35 °C / W 55 °C)	Seasonal energy efficiency	SCOP (η _s %)	4,31/3,26(169/127)	4,31/3,26(169/127)	4,31/3,26(169/127)	4,31/3,26(169/127)
	Energy class ¹⁾	A+++ to D	A++/A++	A++/A++	A++/A++	A++/A++
Indoor unit			WH-ADC0912K6E5	WH-ADC0912K6E5	WH-ADC0912K9E8***	WH-ADC0912K9E8***
Sound pressure	Heat / Cool	dB(A)	33/33	33/33	33/33	33/33
Dimension	H x W x D	mm	1642 x 599 x 602	1642 x 599 x 602	1642 x 599 x 602	1642 x 599 x 602
Net weight		kg	101	101	—	—
Water pipe connector		Inch	R 1¼	R 1¼	R 1¼	R 1¼
A class pump	Number of speeds		Variable Speed	Variable Speed	Variable Speed	Variable Speed
	Input power (Min/Max)	W	— / 145	— / 145	— / 145	— / 145
Heating water flow (ΔT=5 K, 35 °C)		L/min	25,8	34,4	25,8	34,4
Water volume		L	185	185	185	185
Maximum DHW temperature		°C	65	65	65	65
Material inside tank			Stainless steel	Stainless steel	Stainless steel	Stainless steel
Tapping profile according EN16147			L	L	L	L
DHW tank ERP efficiency average / warm / cold ²⁾		A+ to F	A/A+/A	A/A+/A	A/A+/A	A/A+/A
DHW tank ERP average climate η / COPdHWH		η _{wh} % / COPdHWH	112/2,80	112/2,80	112/2,80	112/2,80
DHW tank ERP warm climate η / COPdHWH		η _{wh} % / COPdHWH	132/3,30	132/3,30	132/3,30	132/3,30
DHW tank ERP cold climate η / COPdHWH		η _{wh} % / COPdHWH	88/2,20	88/2,20	88/2,20	88/2,20
Outdoor unit			WH-UXZ09KE5	WH-UXZ12KE5	WH-UXZ09KE8	WH-UXZ12KE8
Sound power ³⁾	Heat	dB(A)	65	65	65	65
Dimension / Net weight	H x W x D	mm / kg	1340 x 900 x 320 / 88	1340 x 900 x 320 / 88	1340 x 900 x 320 / —	1340 x 900 x 320 / —
Refrigerant (R32) / CO ₂ Eq.		kg / T	1,60/1,08	1,60/1,08	1,60/1,08	1,60/1,08
Piping diameter	Liquid / Gas	Inch (mm)	1/4(6,35)/1/2(12,70)	1/4(6,35)/1/2(12,70)	1/4(6,35)/1/2(12,70)	1/4(6,35)/1/2(12,70)
Pipe length range / Elevation difference (in / out)		m / m	3~30/20	3~30/20	3~30/20	3~30/20
Pre-charged pipe length / Additional gas amount		m / g/m	10/30	10/30	10/30	10/30
Operating range - outdoor ambient	Heat	°C	-28 ~ +35	-28 ~ +35	-28 ~ +35	-28 ~ +35
	Cool	°C	+10 ~ +43	+10 ~ +43	+10 ~ +43	+10 ~ +43
Water outlet	Heat / Cool	°C	20~60/5~20	20~60/5~20	20~60/5~20	20~60/5~20
Electrical information			WH-ADC0912K6E5	WH-ADC0912K6E5	WH-ADC0912K9E8***	WH-ADC0912K9E8***
Electric backup heater		kW	6,00	6,00	9,00	9,00
Recommended fuse		A	30/30	30/30	— / —	— / —
Recommended minimum cable size, supply 1 / 2 ⁴⁾		mm ²	3 x 4,0/3 x 4,0	3 x 4,0/3 x 4,0	— / —	— / —

1) Scale from A+++ to D. 2) Scale from A+ to F. 3) Sound power in accordance to 811/2013, 813/2013 and EN12102-1:2017 at +7 °C. 4) Check local regulations. * EER and COP calculation is based in accordance to EN14511. ** This product is designed to comply with the European Water Quality Directive 98/83/EC amended by 2015/1787/EU. The lifespan of the product is not guaranteed in the case of the use of groundwater, such as spring water or well water, the use of tap water when salt or other impurities are contained, nor in areas of acidic water quality. Maintenance and warranty costs related to these cases are the customer's responsibility. *** Available Autumn 23. **** Tentative data.

Accessories	
CZ-RTW1	Additional remote controller for K and L Generations
CZ-TAW1B	Aquarea Smart Cloud for remote control and maintenance through wireless or wired LAN
CZ-TAW1-CBL	10 m extension cable for CZ-TAW1B

Accessories	
CZ-NS5P	Additional functions PCB
PAW-A2W-RTWIRED	Room thermostat
PAW-A2W-RTWIREDLESS	Wireless LCD room thermostat



INTERNET CONTROL: Optional.

NEW Aquarea T-CAP All in One K Generation Single phase / Three phase. Heating and Cooling with Electrical Anode · R32

Energy efficiency: A+++ in heating at 35 °C and A+ in DHW / "A" water pump with variable speed / Stainless steel DHW tank with U-Vacua™ insulation panel / Built-in flow meter.

Flexibility: 598 x 600 footprint / Built-in magnetic water filter.

Comfort: Constant capacity down to -20 °C / Operating range down to -28 °C / 60 °C hot water even at -10 °C outside temperature.

Control: Optimised user interface and improved features [2 zone control, bivalent control].

Connectivity: Optional Aquarea Smart and Service Cloud and integration into BMS projects.



Kit	Single phase (power to indoor)			Three phase (power to indoor)		
	KIT-AXC09KE5AN	KIT-AXC12KE5AN	KIT-AXC09KE8AN	KIT-AXC12KE8AN		
Heating capacity / COP (A +7 °C, W 35 °C)	kW / COP	9,00/5,03	12,10/4,84	9,00/5,03	12,10/4,84	
Heating capacity / COP (A +7 °C, W 55 °C)	kW / COP	9,00/3,07	12,10/3,04	—/—	—/—	
Heating capacity / COP (A +2 °C, W 35 °C)	kW / COP	9,00/3,69	12,00/3,44	9,00/3,69	12,00/3,44	
Heating capacity / COP (A +2 °C, W 55 °C)	kW / COP	9,00/2,31	12,00/2,29	—/—	—/—	
Heating capacity / COP (A -7 °C, W 35 °C)	kW / COP	9,00/3,00	12,00/2,72	—/—	—/—	
Heating capacity / COP (A -7 °C, W 55 °C)	kW / COP	9,00/2,10	12,00/2,00	—/—	—/—	
Cooling capacity / EER (A 35 °C, W 7 °C)	kW / EER	8,80/3,11	10,70/2,68	8,80/3,11	10,70/2,68	
Cooling capacity / EER (A 35 °C, W 18 °C)	kW / EER	8,80/4,63	10,70/3,92	—/—	—/—	
Heating average climate (W 35 °C / W 55 °C)	Seasonal energy efficiency	SCOP (η _s %)	4,96/3,57(195/140)	4,96/3,57(195/140)	4,96/3,57(195/140)	4,96/3,57(195/140)
	Energy class ¹⁾		A+++ / A++	A+++ / A++	A+++ / A++	A+++ / A++
Heating warm climate (W 35 °C / W 55 °C)	Seasonal energy efficiency	SCOP (η _s %)	6,47/4,34(256/171)	6,47/4,34(256/171)	6,47/4,34(256/171)	6,47/4,34(256/171)
	Energy class ¹⁾		A+++ / A+++	A+++ / A+++	A+++ / A+++	A+++ / A+++
Heating cold climate (W 35 °C / W 55 °C)	Seasonal energy efficiency	SCOP (η _s %)	4,31/3,26(169/127)	4,31/3,26(169/127)	4,31/3,26(169/127)	4,31/3,26(169/127)
	Energy class ¹⁾		A++ / A++	A++ / A++	A++ / A++	A++ / A++
Indoor unit			WH-ADC0912K9E8AN	WH-ADC0912K9E8AN	WH-ADC0912K9E8AN	WH-ADC0912K9E8AN
Sound pressure	Heat / Cool	dB(A)	33/33	33/33	33/33	33/33
Dimension	H x W x D	mm	1642 x 599 x 602	1642 x 599 x 602	1642 x 599 x 602	1642 x 599 x 602
Net weight		kg	101	101	101	101
Water pipe connector		Inch	R 1½	R 1½	R 1½	R 1½
A class pump	Number of speeds		Variable Speed	Variable Speed	Variable Speed	Variable Speed
	Input power (Min/Max)	W	—/145	—/145	—/145	—/145
Heating water flow (ΔT=5 K, 35 °C)		L/min	25,8	34,4	25,8	34,4
Water volume		L	185	185	185	185
Maximum DHW temperature		°C	65	65	65	65
Material inside tank			Stainless steel	Stainless steel	Stainless steel	Stainless steel
Tapping profile according EN16147			L	L	L	L
DHW tank ERP efficiency average / warm / cold ²⁾		A+ to F	A / A+ / A	A / A+ / A	A / A+ / A	A / A+ / A
DHW tank ERP average climate η / COP _{DHW}	η _{wh} % / COP _{DHW}		112/2,80	112/2,80	112/2,80	112/2,80
DHW tank ERP warm climate η / COP _{DHW}	η _{wh} % / COP _{DHW}		132/3,30	132/3,30	132/3,30	132/3,30
DHW tank ERP cold climate η / COP _{DHW}	η _{wh} % / COP _{DHW}		88/2,20	88/2,20	88/2,20	88/2,20
Outdoor unit			WH-UXZ09KE5	WH-UXZ12KE5	WH-UXZ09KE8	WH-UXZ12KE8
Sound power ³⁾	Heat	dB(A)	65	65	65	65
Dimension / Net weight	H x W x D	mm / kg	1340 x 900 x 320 / 88	1340 x 900 x 320 / 88	1340 x 900 x 320 / 88	1340 x 900 x 320 / 88
Refrigerant (R32) / CO ₂ Eq.		kg / T	1,60/1,08	1,60/1,08	1,60/1,08	1,60/1,08
Piping diameter	Liquid / Gas	Inch (mm)	1/4 (6,35) / 1/2 (12,70)	1/4 (6,35) / 1/2 (12,70)	1/4 (6,35) / 1/2 (12,70)	1/4 (6,35) / 1/2 (12,70)
Pipe length range / Elevation difference (in / out)		m / m	3~30/20	3~30/20	3~30/20	3~30/20
Pre-charged pipe length / Additional gas amount		m / g/m	10/30	10/30	10/30	10/30
Operating range - outdoor ambient	Heat	°C	-28~+35	-28~+35	-28~+35	-28~+35
	Cool	°C	+10~+43	+10~+43	+10~+43	+10~+43
Water outlet	Heat / Cool	°C	20~60/5~20	20~60/5~20	20~60/5~20	20~60/5~20
Electrical information			WH-ADC0912K9E8AN	WH-ADC0912K9E8AN	WH-ADC0912K9E8AN	WH-ADC0912K9E8AN
Electric backup heater		kW	6,00	6,00	9,00	9,00
Recommended fuse		A	30/30	30/30	—/—	—/—
Recommended minimum cable size, supply 1 / 2 ⁴⁾		mm ²	3 x 4,0 / 3 x 4,0	3 x 4,0 / 3 x 4,0	—/—	—/—

1) Scale from A+++ to D. 2) Scale from A+ to F. 3) Sound power in accordance to 811/2013, 813/2013 and EN12102-1:2017 at +7 °C. 4) Check local regulations. * EER and COP calculation is based in accordance to EN14511. ** This product is designed to comply with the European Water Quality Directive 98/83/EC amended by 2015/1787/EU. The lifespan of the product is not guaranteed in the case of the use of groundwater, such as spring water or well water, the use of tap water when salt or other impurities are contained, nor in areas of acidic water quality. Maintenance and warranty costs related to these cases are the customer's responsibility. *** Tentative data.

Accessories	
CZ-RTW1	Additional remote controller for K and L Generations
CZ-TAW1B	Aquarea Smart Cloud for remote control and maintenance through wireless or wired LAN
CZ-TAW1-CBL	10 m extension cable for CZ-TAW1B

Accessories	
CZ-NS5P	Additional functions PCB
PAW-A2W-RTWIRED	Room thermostat
PAW-A2W-RTWIREDLESS	Wireless LCD room thermostat



INTERNET CONTROL: Optional.

Aquarea T-CAP All in One H Generation Single phase / Three phase. Heating and Cooling · R410A

Energy efficiency: A+++ in heating at 35 °C and A+ in DHW / "A" water pump with variable speed / Stainless steel DHW tank with U-Vacua™ insulation panel / Built-in flow meter.

Flexibility: Optional magnet for the water filter.

Comfort: Constant capacity down to -20 °C / Operating range down to -28 °C / 60 °C water outlet temperature.

Control: Additional functions with optional PCB (2 zone control, bivalent control, Smart Grid contact and more).

Connectivity: Optional Aquarea Smart and Service Cloud and integration into BMS projects.



011-1W0510
011-1W0511



Kit	Single phase (power to indoor)		Three phase (power to indoor)				
		KIT-AXC09HE5	KIT-AXC12HE5	KIT-AXC09HE8	KIT-AXC12HE8	KIT-AXC16HE8	
Heating capacity / COP (A +7 °C, W 35 °C)	kW / COP	9,00/4,84	12,00/4,74	9,00/4,84	12,00/4,74	16,00/4,28	
Heating capacity / COP (A +7 °C, W 55 °C)	kW / COP	9,00/2,94	12,00/2,88	9,00/2,94	12,00/2,88	16,00/2,71	
Heating capacity / COP (A +2 °C, W 35 °C)	kW / COP	9,00/3,59	12,00/3,44	9,00/3,59	12,00/3,44	16,00/3,10	
Heating capacity / COP (A +2 °C, W 55 °C)	kW / COP	9,00/2,21	12,00/2,19	9,00/2,21	12,00/2,19	16,00/2,13	
Heating capacity / COP (A -7 °C, W 35 °C)	kW / COP	9,00/2,85	12,00/2,72	9,00/2,85	12,00/2,72	16,00/2,49	
Heating capacity / COP (A -7 °C, W 55 °C)	kW / COP	9,00/2,02	12,00/1,92	9,00/2,02	12,00/1,92	16,00/1,86	
Cooling capacity / EER (A 35 °C, W 7 °C)	kW / EER	7,00/3,17	10,00/2,81	7,00/3,17	10,00/2,81	12,20/2,57	
Cooling capacity / EER (A 35 °C, W 18 °C)	kW / EER	7,00/5,19	10,00/5,13	7,00/5,19	10,00/5,13	12,20/3,49	
Heating average climate (W 35 °C / W 55 °C)	Seasonal energy efficiency	SCOP (η _s %)	4,59/3,32(181/130)	4,32/3,32(170/130)	4,59/3,32(181/130)	4,32/3,32(170/130)	4,08/3,20(160/125)
	Energy class ¹⁾	A+++ to D	A+++/A++	A++/A++	A+++/A++	A++/A++	A++/A++
Heating warm climate (W 35 °C / W 55 °C)	Seasonal energy efficiency	SCOP (η _s %)	5,95/4,02(235/158)	5,86/4,02(231/158)	5,95/4,02(235/158)	5,86/4,02(231/158)	5,86/4,05(231/159)
	Energy class ¹⁾	A+++ to D	A+++/A+++	A+++/A+++	A+++/A+++	A+++/A+++	A+++/A+++
Heating cold climate (W 35 °C / W 55 °C)	Seasonal energy efficiency	SCOP (η _s %)	4,08/3,20(160/125)	4,08/3,20(160/125)	4,08/3,20(160/125)	4,08/3,20(160/125)	3,83/3,20(150/125)
	Energy class ¹⁾	A+++ to D	A++/A++	A++/A++	A++/A++	A++/A++	A++/A++
Indoor unit			WH-ADC1216H6E5	WH-ADC1216H6E5	WH-ADC0916H9E8	WH-ADC0916H9E8	WH-ADC0916H9E8
Sound pressure	Heat / Cool	dB(A)	33/33	33/33	33/33	33/33	33/33
Dimension	HxWxD	mm	1800x598x717	1800x598x717	1800x598x717	1800x598x717	1800x598x717
Net weight		kg	124	124	126	126	126
Water pipe connector		Inch	R 1½	R 1½	R 1½	R 1½	R 1½
A class pump	Number of speeds		Variable Speed	Variable Speed	Variable Speed	Variable Speed	Variable Speed
	Input power (Min/Max)	W	36/152	36/152	36/152	36/152	36/152
Heating water flow (ΔT=5 K. 35 °C)		L/min	25,8	34,4	25,8	34,4	45,9
Electric backup heater		kW	6,00	6,00	9,00	9,00	9,00
Recommended fuse		A	30/30	30/30	16/16	16/16	16/16
Recommended minimum cable size, supply 1 / 2 ²⁾		mm ²	3x4,0/3x4,0	3x4,0/3x4,0	5x1,5/5x1,5	5x1,5/5x1,5	5x1,5/5x1,5
Water volume		L	185	185	185	185	185
Maximum DHW temperature		°C	65	65	65	65	65
Material inside tank			Stainless steel	Stainless steel	Stainless steel	Stainless steel	Stainless steel
Tapping profile according EN16147			L	L	L	L	L
DHW tank ERP efficiency average / warm / cold ³⁾	A+ to F	A/A/A	A/A/A	A/A/A	A/A/A	A/A/A	A/A/B
DHW tank ERP average climate η / COPdHW	η _{wh} %/COPdHW	95/2,37	95/2,37	95/2,37	95/2,37	95/2,37	91/2,27
DHW tank ERP warm climate η / COPdHW	η _{wh} %/COPdHW	110/2,75	110/2,75	110/2,75	110/2,75	110/2,75	107/2,67
DHW tank ERP cold climate η / COPdHW	η _{wh} %/COPdHW	75/1,87	75/1,87	75/1,87	75/1,87	75/1,87	72/1,80
Outdoor unit			WH-UX09HE5	WH-UX12HE5	WH-UX09HE8	WH-UX12HE8	WH-UX16HE8
Sound power ⁴⁾	Heat	dB(A)	66	66	65	65	67
Dimension / Net weight	HxWxD	mm / kg	1340x900x320/101	1340x900x320/101	1340x900x320/108	1340x900x320/108	1340x900x320/118
Refrigerant (R410A) / CO ₂ Eq.	kg / T		2,85/5,951	2,85/5,951	2,85/5,951	2,85/5,951	2,90/6,055
Piping diameter	Liquid / Gas	Inch (mm)	3/8(9,52)/5/8(15,88)	3/8(9,52)/5/8(15,88)	3/8(9,52)/5/8(15,88)	3/8(9,52)/5/8(15,88)	3/8(9,52)/5/8(15,88)
Pipe length range / Elevation difference (in / out)	m / m		3-30/20	3-30/20	3-30/20	3-30/20	3-30/20
Pre-charged pipe length / Additional gas amount	m / g/m		10/50	10/50	10/50	10/50	10/50
Operating range - outdoor ambient	Heat	°C	-28 ~ +35	-28 ~ +35	-28 ~ +35	-28 ~ +35	-28 ~ +35
	Cool	°C	+16 ~ +43	+16 ~ +43	+16 ~ +43	+16 ~ +43	+16 ~ +43
Water outlet	Heat / Cool	°C	20-60/5-20	20-60/5-20	20-60/5-20	20-60/5-20	20-60/5-20

1) Scale from A+++ to D. 2) Check local regulations. 3) Scale from A+ to F. 4) Sound power in accordance to 811/2013, 813/2013 and EN12102-1:2017 at +7 °C. * EER and COP calculation is based in accordance to EN14511. ** This product is designed to comply with the European Water Quality Directive 98/83/EC amended by 2015/1787/EU. The lifespan of the product is not guaranteed in the case of the use of groundwater, such as spring water or well water, the use of tap water when salt or other impurities are contained, nor in areas of acidic water quality. Maintenance and warranty costs related to these cases are the customer's responsibility.

Accessories	
PAW-ADC-PREKIT-1	Piping pre installation kit for J Generation
CZ-TAW1B	Aquarea Smart Cloud for remote control and maintenance through wireless or wired LAN
CZ-TAW1-CBL	10 m extension cable for CZ-TAW1B

Accessories	
CZ-NS4P	Additional functions PCB
PAW-A2W-MGTFILTER	Magnet for the water filter
PAW-A2W-RTWIRED	Room thermostat
PAW-A2W-RTWIRELESS	Wireless LCD room thermostat



INTERNET CONTROL: Optional.

Aquarea T-CAP All in One H Generation Three phase. Super Quiet outdoor unit. Heating and Cooling · R410A

Energy efficiency: A+++ in heating at 35 °C and A+ in DHW / "A" water pump with variable speed / Stainless steel DHW tank with U-Vacua™ insulation panel / Built-in flow meter.

Flexibility: Optional magnet for the water filter.

Comfort: Low noise level / Constant capacity down to -20 °C / Operating range down to -28 °C / 60 °C water outlet temperature.

Control: Additional functions with optional PCB (2 zone control, bivalent control, Smart Grid contact and more).

Connectivity: Optional Aquarea Smart and Service Cloud and integration into BMS projects.



011-1W0510
011-1W0511

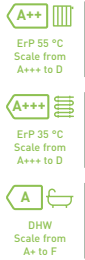

				Three phase (power to indoor)		
Kit			KIT-AQC09HE8	KIT-AQC12HE8	KIT-AQC16HE8	
Heating capacity / COP (A +7 °C, W 35 °C)		kW / COP	9,00/4,84	12,00/4,74	16,00/4,28	
Heating capacity / COP (A +7 °C, W 55 °C)		kW / COP	9,00/2,94	12,00/2,88	16,00/2,71	
Heating capacity / COP (A +2 °C, W 35 °C)		kW / COP	9,00/3,59	12,00/3,44	16,00/3,10	
Heating capacity / COP (A +2 °C, W 55 °C)		kW / COP	9,00/2,21	12,00/2,19	16,00/2,13	
Heating capacity / COP (A -7 °C, W 35 °C)		kW / COP	9,00/2,85	12,00/2,72	16,00/2,49	
Heating capacity / COP (A -7 °C, W 55 °C)		kW / COP	9,00/2,02	12,00/1,92	16,00/1,86	
Cooling capacity / EER (A 35 °C, W 7 °C)		kW / EER	7,00/3,17	10,00/2,81	12,20/2,57	
Cooling capacity / EER (A 35 °C, W 18 °C)		kW / EER	7,00/5,19	10,00/5,13	12,20/3,49	
Heating average climate (W 35 °C / W 55 °C)		Seasonal energy efficiency SCOP (η _s %)	4,59/3,32(181/130)	4,32/3,32(170/130)	4,08/3,20(160/125)	
		Energy class ¹⁾	A+++ to D	A++/A++	A++/A++	
Heating warm climate (W 35 °C / W 55 °C)		Seasonal energy efficiency SCOP (η _s %)	5,95/4,02(235/158)	5,86/4,02(231/158)	5,86/4,05(231/159)	
		Energy class ¹⁾	A+++ to D	A+++/A+++	A+++/A+++	
Heating cold climate (W 35 °C / W 55 °C)		Seasonal energy efficiency SCOP (η _s %)	4,08/3,20(160/125)	4,08/3,20(160/125)	3,83/3,20(150/125)	
		Energy class ¹⁾	A+++ to D	A++/A++	A++/A++	
Indoor unit			WH-ADC0916H9E8	WH-ADC0916H9E8	WH-ADC0916H9E8	
Sound pressure		Heat / Cool	33/33	33/33	33/33	
Dimension		HxWxD	1800x598x717	1800x598x717	1800x598x717	
Net weight		kg	126	126	126	
Water pipe connector		Inch	R 1½	R 1½	R 1½	
A class pump		Number of speeds	Variable Speed	Variable Speed	Variable Speed	
		Input power (Min/Max)	W	36/152	36/152	36/152
Heating water flow (ΔT=5 K, 35 °C)		L/min	25,8	34,4	45,9	
Electric backup heater		kW	9,00	9,00	9,00	
Recommended fuse		A	16/16	16/16	16/16	
Recommended minimum cable size, supply 1 / 2 ²⁾		mm ²	5x1,5/5x1,5	5x1,5/5x1,5	5x1,5/5x1,5	
Water volume		L	185	185	185	
Maximum DHW temperature		°C	65	65	65	
Material inside tank			Stainless steel	Stainless steel	Stainless steel	
Tapping profile according EN16147			L	L	L	
DHW tank ERP efficiency average / warm / cold ³⁾		A+ to F	A/A/A	A/A/A	A/A/B	
DHW tank ERP average climate η / COPdHW		η _{wh} %/COPdHW	95/2,37	95/2,37	91/2,27	
DHW tank ERP warm climate η / COPdHW		η _{wh} %/COPdHW	110/2,75	110/2,75	107/2,67	
DHW tank ERP cold climate η / COPdHW		η _{wh} %/COPdHW	75/1,87	75/1,87	72/1,80	
Outdoor unit			WH-UQ09HE8	WH-UQ12HE8	WH-UQ16HE8	
Sound power ⁴⁾		Heat	58	58	62	
Dimension / Net weight		HxWxD	1410x1283x320/151	1410x1283x320/151	1410x1283x320/161	
Refrigerant (R410A) / CO ₂ Eq.		kg / T	2,85/5,951	2,85/5,951	2,99/6,243	
Piping diameter		Liquid / Gas	3/8(9,52)/5/8(15,88)	3/8(9,52)/5/8(15,88)	3/8(9,52)/5/8(15,88)	
Pipe length range / Elevation difference (in / out)		m / m	3~30/20	3~30/20	3~30/20	
Pre-charged pipe length / Additional gas amount		m / g/m	10/50	10/50	10/50	
Operating range - outdoor ambient		Heat	-28~+35	-28~+35	-28~+35	
		Cool	+16~+43	+16~+43	+16~+43	
Water outlet		Heat / Cool	20~60/5~20	20~60/5~20	20~60/5~20	

1) Scale from A+++ to D. 2) Check local regulations. 3) Scale from A+ to F. 4) Sound power in accordance to 811/2013, 813/2013 and EN12102-1:2017 at +7 °C. * EER and COP calculation is based in accordance to EN14511. ** This product is designed to comply with the European Water Quality Directive 98/83/EC amended by 2015/1787/EU. The lifespan of the product is not guaranteed in the case of the use of groundwater, such as spring water or well water, the use of tap water when salt or other impurities are contained, nor in areas of acidic water quality. Maintenance and warranty costs related to these cases are the customer's responsibility.

Accessories	
PAW-ADC-PREKIT-1	Piping pre installation kit for J Generation
CZ-TAW1B	Aquarea Smart Cloud for remote control and maintenance through wireless or wired LAN
CZ-TAW1-CBL	10 m extension cable for CZ-TAW1B

Accessories	
CZ-NS4P	Additional functions PCB
PAW-A2W-MGTFILTER	Magnet for the water filter
PAW-A2W-RTWIRED	Room thermostat
PAW-A2W-RTWIRELESS	Wireless LCD room thermostat



INTERNET CONTROL: Optional.

Aquarea T-CAP All in One Compact H Generation Single phase. Heating and Cooling · R410A

Energy efficiency: A+++ in heating at 35 °C and A in DHW / "A" water pump with variable speed / Stainless steel DHW tank with U-Vacua™ insulation panel / Built-in flow meter.

Flexibility: 598 x 600 footprint / Built-in magnetic water filter.

Comfort: Constant capacity down to -20 °C / Operating range down to -28 °C / 60 °C water outlet temperature.

Control: Additional functions with optional PCB (2 zone control, bivalent control, Smart Grid contact and more).

Connectivity: Optional Aquarea Smart and Service Cloud and integration into BMS projects.



Single phase (power to indoor)

Kit		KIT-AXC09HE5C		KIT-AXC12HE5C	
Heating capacity / COP (A +7 °C, W 35 °C)	kW / COP	9,00/4,84	12,00/4,74		
Heating capacity / COP (A +7 °C, W 55 °C)	kW / COP	9,00/2,94	12,00/2,88		
Heating capacity / COP (A +2 °C, W 35 °C)	kW / COP	9,00/3,59	12,00/3,44		
Heating capacity / COP (A +2 °C, W 55 °C)	kW / COP	9,00/2,21	12,00/2,19		
Heating capacity / COP (A -7 °C, W 35 °C)	kW / COP	9,00/2,85	12,00/2,72		
Heating capacity / COP (A -7 °C, W 55 °C)	kW / COP	9,00/2,02	12,00/1,92		
Cooling capacity / EER (A 35 °C, W 7 °C)	kW / EER	7,00/3,17	10,00/2,81		
Cooling capacity / EER (A 35 °C, W 18 °C)	kW / EER	7,00/5,19	10,00/5,13		
Heating average climate (W 35 °C / W 55 °C)	Seasonal energy efficiency	SCOP (η _s %)	4,59/3,32(181/130)	4,32/3,32(170/130)	
	Energy class ¹⁾	A+++ to D	A+++ / A++	A++ / A++	
Heating warm climate (W 35 °C / W 55 °C)	Seasonal energy efficiency	SCOP (η _s %)	5,95/4,02(235/158)	5,86/4,02(231/158)	
	Energy class ¹⁾	A+++ to D	A+++ / A+++	A+++ / A+++	
Heating cold climate (W 35 °C / W 55 °C)	Seasonal energy efficiency	SCOP (η _s %)	4,08/3,20(160/125)	4,08/3,20(160/125)	
	Energy class ¹⁾	A+++ to D	A++ / A++	A++ / A++	
Indoor unit		WH-ADC1216H6E5C		WH-ADC1216H6E5C	
Sound pressure	Heat / Cool	dB(A)	33/33	33/33	
Dimension	H x W x D	mm	1642 x 599 x 602	1642 x 599 x 602	
Net weight		kg	101	101	
Water pipe connector		Inch	R 1½	R 1½	
A class pump	Number of speeds		Variable Speed	Variable Speed	
	Input power (Min/Max)	W	— / —	— / —	
Heating water flow (ΔT=5 K, 35 °C)		L/min	25,80	34,40	
Electric backup heater		kW	6,00	6,00	
Recommended fuse		A	— / —	— / —	
Recommended minimum cable size, supply 1 / 2 ²⁾		mm ²	— / —	— / —	
Water volume		L	185	185	
Maximum DHW temperature		°C	65	65	
Material inside tank			Stainless steel	Stainless steel	
Tapping profile according EN16147			—	—	
DHW tank ERP efficiency average / warm / cold ³⁾		A+ to F	— / — / —	— / — / —	
DHW tank ERP average climate η / COPdHW		η _{wh} % / COPdHW	92/2,30	92/2,30	
DHW tank ERP warm climate η / COPdHW		η _{wh} % / COPdHW	107/2,67	107/2,67	
DHW tank ERP cold climate η / COPdHW		η _{wh} % / COPdHW	72/1,81	72/1,81	
Outdoor unit		WH-UX09HE5		WH-UX12HE5	
Sound power ⁴⁾	Heat	dB(A)	66	66	
Dimension / Net weight	H x W x D	mm / kg	1340 x 900 x 320 / 101	1340 x 900 x 320 / 101	
Refrigerant (R410A) / CO ₂ Eq.		kg / T	2,85/5,951	2,85/5,951	
Piping diameter	Liquid / Gas	Inch (mm)	3/8(9,52)/5/8(15,88)	3/8(9,52)/5/8(15,88)	
Pipe length range / Elevation difference (in / out)		m / m	3 ~ 30 / 20	3 ~ 30 / 20	
Pre-charged pipe length / Additional gas amount		m / g/m	10 / 50	10 / 50	
Operating range - outdoor ambient	Heat	°C	-28 ~ +35	-28 ~ +35	
	Cool	°C	+16 ~ +43	+16 ~ +43	
Water outlet	Heat / Cool	°C	20 ~ 60 / 5 ~ 20	20 ~ 60 / 5 ~ 20	

1) Scale from A+++ to D. 2) Check local regulations. 3) Scale from A+ to F. 4) Sound power in accordance to 811/2013, 813/2013 and EN12102-1:2017 at +7 °C. * EER and COP calculation is based in accordance to EN14511. ** This product is designed to comply with the European Water Quality Directive 98/83/EC amended by 2015/1787/EU. The lifespan of the product is not guaranteed in the case of the use of groundwater, such as spring water or well water, the use of tap water when salt or other impurities are contained, nor in areas of acidic water quality. Maintenance and warranty costs related to these cases are the customer's responsibility.

Accessories

CZ-TAW1B	Aquarea Smart Cloud for remote control and maintenance through wireless or wired LAN
CZ-TAW1-CBL	10 m extension cable for CZ-TAW1B

Accessories

CZ-NS4P	Additional functions PCB
PAW-A2W-RTWIRED	Room thermostat
PAW-A2W-RTWIRELESS	Wireless LCD room thermostat



INTERNET CONTROL: Optional.

NEW Aquarea T-CAP Bi-bloc K Generation Single phase / Three phase. Heating and Cooling · R32

Energy efficiency: A+++ in heating at 35 °C and A+ in DHW / "A" water pump with variable speed / Built-in flow meter.

Flexibility: Built-in magnetic water filter.

Comfort: Constant capacity down to -20 °C / Operating range down to -28 °C / 60 °C hot water even at -10 °C outside temperature.

Control: Optimised user interface and improved features (2 zone control, bivalent control).

Connectivity: Optional Aquarea Smart and Service Cloud and integration into BMS projects.



Tentative data

		Single phase (power to indoor)		Three phase (power to indoor)		
Kit 3 kW electric heater		KIT-WXC09K3E5	—	KIT-WXC09K3E8		
Kit 6 kW electric heater		KIT-WXC09K6E5	KIT-WXC12K6E5	—		
Kit 9 kW electric heater		—	—	KIT-WXC09K9E8	KIT-WXC12K9E8	
Heating capacity / COP (A +7 °C, W 35 °C)	kW / COP	9,00/5,03	12,10/4,84	9,00/5,03	12,10/4,84	
Heating capacity / COP (A +7 °C, W 55 °C)	kW / COP	9,00/3,07	12,10/3,04	—/—	—/—	
Heating capacity / COP (A +2 °C, W 35 °C)	kW / COP	9,00/3,69	12,00/3,44	9,00/3,69	12,00/3,44	
Heating capacity / COP (A +2 °C, W 55 °C)	kW / COP	9,00/2,31	12,00/2,29	—/—	—/—	
Heating capacity / COP (A -7 °C, W 35 °C)	kW / COP	9,00/3,00	12,00/2,72	—/—	—/—	
Heating capacity / COP (A -7 °C, W 55 °C)	kW / COP	9,00/2,10	12,00/2,00	—/—	—/—	
Cooling capacity / EER (A 35 °C, W 7 °C)	kW / EER	8,80/3,11	10,70/2,68	8,80/3,11	10,70/2,68	
Cooling capacity / EER (A 35 °C, W 18 °C)	kW / EER	8,80/4,63	10,70/3,92	—/—	—/—	
Heating average climate (W 35 °C / W 55 °C)	Seasonal energy efficiency	SCOP (η _s , %)	4,96/3,57(195/140)	4,96/3,57(195/140)	4,96/3,57(195/140)	4,96/3,57(195/140)
	Energy class ¹⁾		A+++ to D	A+++/A++	A+++/A++	A+++/A++
Heating warm climate (W 35 °C / W 55 °C)	Seasonal energy efficiency	SCOP (η _s , %)	6,47/4,34(256/171)	6,47/4,34(256/171)	6,47/4,34(256/171)	6,47/4,34(256/171)
	Energy class ¹⁾		A+++ to D	A+++/A+++	A+++/A+++	A+++/A+++
Heating cold climate (W 35 °C / W 55 °C)	Seasonal energy efficiency	SCOP (η _s , %)	4,31/3,26(169/127)	4,31/3,26(169/127)	4,31/3,26(169/127)	4,31/3,26(169/127)
	Energy class ¹⁾		A+++ to D	A++/A++	A++/A++	A++/A++
Indoor unit 3 kW electric heater		WH-SXC09K3E5	—	WH-SXC09K3E8		
Indoor unit 6 kW electric heater		WH-SXC09K6E5	WH-SXC12K6E5	—		
Indoor unit 9 kW electric heater		—	—	WH-SXC09K9E8	WH-SXC12K9E8	
Sound pressure	Heat / Cool	dB(A)	33/33	33/33	33/33	
Dimension	H x W x D	mm	892 x 500 x 348	892 x 500 x 348	892 x 500 x 348	
Net weight		kg	—	—	—	
Water pipe connector		Inch	R 1¼	R 1¼	R 1¼	
A class pump	Number of speeds		Variable Speed	Variable Speed	Variable Speed	
	Input power (Min/Max)	W	—/145	—/145	—/145	
Heating water flow (ΔT=5 K, 35 °C)		L/min	25,8	34,4	25,8	
Outdoor unit		WH-UXZ09KE5	WH-UXZ12KE5	WH-UXZ09KE8	WH-UXZ12KE8	
Sound power ²⁾	Heat	dB(A)	65	65	65	
Dimension	H x W x D	mm	1340 x 900 x 320	1340 x 900 x 320	1340 x 900 x 320	
Net weight		kg	88	88	88	
Refrigerant (R32) / CO ₂ Eq.		kg / T	1,60/1,08	1,60/1,08	1,60/1,08	
Piping diameter	Liquid / Gas	Inch (mm)	1/4(6,35)/1/2(12,70)	1/4(6,35)/1/2(12,70)	1/4(6,35)/1/2(12,70)	
Pipe length range		m	3~30	3~30	3~30	
Elevation difference (in / out)		m	20	20	20	
Pre-charged pipe length		m	10	10	10	
Additional gas amount		g/m	30	30	30	
Operating range - outdoor ambient	Heat	°C	-28~+35	-28~+35	-28~+35	
	Cool	°C	+10~+43	+10~+43	+10~+43	
Water outlet	Heat / Cool	°C	20~60/5~20	20~60/5~20	20~60/5~20	
Electrical information			3 kW heater	6 kW heater	6 kW heater	
Electric backup heater		kW	3,00	6,00	6,00	
Recommended fuse		A	—/—	—/—	—/—	
Recommended minimum cable size, supply 1 / 2 ³⁾		mm ²	—/—	—/—	—/—	

1) Scale from A+++ to D. 2) Sound power in accordance to 811/2013, 813/2013 and EN12102-1:2017 at +7 °C. 3) Check local regulations. * EER and COP calculation is based in accordance to EN14511. ** This product is designed to comply with the European Water Quality Directive 98/83/EC amended by 2015/1787/EU. The lifespan of the product is not guaranteed in the case of the use of groundwater, such as spring water or well water, the use of tap water when salt or other impurities are contained, nor in areas of acidic water quality. Maintenance and warranty costs related to these cases are the customer's responsibility. *** Tentative data.

Accessories	
CZ-RTW1	Additional remote controller for K and L Generations
PAW-TD20C1E5-1	Tank 200 L - Stainless steel
PAW-TD30C1E5-1	Tank 300 L - Stainless steel
PAW-TA20C1E5STD	Tank 200 L - Enamelled
PAW-TA30C1E5STD	Tank 300 L - Enamelled
PAW-3WYVLV-HW	3 way valve for DHW tanks
CZ-NV2	3 way valve kit for inside of hydrokit for K and L Generations

Accessories	
PAW-BTANK50L-2	Buffer tank 50 L
CZ-TAW1B	Aquarea Smart Cloud for remote control and maintenance through wireless or wired LAN
CZ-TAW1-CBL	10 m extension cable for CZ-TAW1B
CZ-NS5P	Additional functions PCB
PAW-A2W-MGTFILTER	Magnet for the water filter
PAW-A2W-RTWIRED	Room thermostat
PAW-A2W-RTWIREDLESS	Wireless LCD room thermostat



INTERNET CONTROL: Optional.

Aquarea T-CAP Bi-bloc H Generation Single phase / Three phase. Heating and Cooling - SXC · R410A

Energy efficiency: A+++ in heating at 35 °C / "A" water pump with variable speed / Built-in flow meter.

Flexibility: Optional magnet for the water filter.

Comfort: Constant capacity down to -20 °C / Operating range down to -28 °C / 60 °C water outlet temperature.

Control: Additional functions with optional PCB (2 zone control, bivalent control, Smart Grid contact and more).

Connectivity: Optional Aquarea Smart and Service Cloud and integration into BMS projects.



011-1W0510
011-1W0511



Kit	Single phase (power to indoor)			Three phase (power to indoor)		
	KIT-WXC09H3E5	KIT-WXC12H6E5	KIT-WXC09H3E8	KIT-WXC12H9E8	KIT-WXC16H9E8	
Heating capacity / COP (A +7 °C, W 35 °C)	kW / COP 9,00/4,84	12,00/4,74	9,00/4,84	12,00/4,74	16,00/4,28	
Heating capacity / COP (A +7 °C, W 55 °C)	kW / COP 9,00/2,94	12,00/2,88	9,00/2,94	12,00/2,88	16,00/2,71	
Heating capacity / COP (A +2 °C, W 35 °C)	kW / COP 9,00/3,59	12,00/3,44	9,00/3,59	12,00/3,44	16,00/3,10	
Heating capacity / COP (A +2 °C, W 55 °C)	kW / COP 9,00/2,21	12,00/2,19	9,00/2,21	12,00/2,19	16,00/2,13	
Heating capacity / COP (A -7 °C, W 35 °C)	kW / COP 9,00/2,85	12,00/2,72	9,00/2,85	12,00/2,72	16,00/2,49	
Heating capacity / COP (A -7 °C, W 55 °C)	kW / COP 9,00/2,02	12,00/1,92	9,00/2,02	12,00/1,92	16,00/1,86	
Cooling capacity / EER (A 35 °C, W 7 °C)	kW / EER 7,00/3,17	10,00/2,81	7,00/3,17	10,00/2,81	12,20/2,57	
Cooling capacity / EER (A 35 °C, W 18 °C)	kW / EER 7,00/5,19	10,00/5,13	7,00/5,19	10,00/5,13	12,20/3,49	
Heating average climate (W 35 °C / W 55 °C)	Seasonal energy efficiency SCOP (η _s %)	4,59/3,32(181/130)	4,32/3,32(170/130)	4,59/3,32(181/130)	4,32/3,32(170/130)	4,08/3,20(160/125)
	Energy class	A+++ to D	A+++ / A++	A+++ / A++	A+++ / A++	A+++ / A++
Heating warm climate (W 35 °C / W 55 °C)	Seasonal energy efficiency SCOP (η _s %)	5,95/4,02(235/158)	5,86/4,02(231/158)	5,95/4,02(235/158)	5,86/4,02(231/158)	5,86/4,05(231/159)
	Energy class	A+++ to D	A+++ / A+++	A+++ / A+++	A+++ / A+++	A+++ / A+++
Heating cold climate (W 35 °C / W 55 °C)	Seasonal energy efficiency SCOP (η _s %)	4,08/3,20(160/125)	4,08/3,20(160/125)	4,08/3,20(160/125)	4,08/3,20(160/125)	3,83/3,20(150/125)
	Energy class	A+++ to D	A++ / A++	A++ / A++	A++ / A++	A++ / A++
Indoor unit		WH-SXC09H3E5	WH-SXC12H6E5	WH-SXC09H3E8	WH-SXC12H9E8	WH-SXC16H9E8
Sound pressure	Heat / Cool	dB(A) 33/33		33/33		33/33
Dimension	H x W x D	mm 892 x 500 x 340		892 x 500 x 340		892 x 500 x 340
Net weight		kg 43		43		45
Water pipe connector		Inch R 1½		R 1½		R 1½
A class pump	Number of speeds	Variable Speed		Variable Speed		Variable Speed
	Input power (Min/Max)	W 32/102		34/110		30/105
Heating water flow (ΔT=5 K, 35 °C)	L/min	25,8		34,4		45,9
Electric backup heater	kW	3,00		6,00		9,00
Recommended fuse	A	30/30		30/30		16/16
Recommended minimum cable size, supply 1 / 2 ¹⁾	mm ²	3 x 4,0 or 6,0 / 3 x 4,0		3 x 4,0 or 6,0 / 3 x 4,0		5 x 1,5 / 3 x 1,5
Outdoor unit		WH-UX09H5	WH-UX12H5	WH-UX09H8	WH-UX12H8	WH-UX16H8
Sound power ²⁾	Heat	dB(A) 66		66		65
Dimension	H x W x D	mm 1340 x 900 x 320		1340 x 900 x 320		1340 x 900 x 320
Net weight		kg 101		101		108
Refrigerant (R410A) / CO ₂ Eq.	kg / T	2,85/5,951		2,85/5,951		2,85/5,951
Piping diameter	Liquid / Gas	Inch (mm) 3/8(9,52)/5/8(15,88)		3/8(9,52)/5/8(15,88)		3/8(9,52)/5/8(15,88)
Pipe length range		m 3-30		3-30		3-30
Elevation difference (in / out)		m 20		20		20
Pre-charged pipe length		m 10		10		10
Additional gas amount		g/m 50		50		50
Operating range - outdoor ambient	Heat	°C -28 ~ +35		-28 ~ +35		-28 ~ +35
	Cool	°C +16 ~ +43		+16 ~ +43		+16 ~ +43
Water outlet	Heat / Cool	°C 20 ~ 60/5 ~ 20		20 ~ 60/5 ~ 20		20 ~ 60/5 ~ 20

1) Check local regulations. 2) Sound power in accordance to 811/2013, 813/2013 and EN12102-1:2017 at +7 °C. * EER and COP calculation is based in accordance to EN14511.

Accessories	
PAW-TD20C1E5-1	Tank 200 L - Stainless steel
PAW-TD30C1E5-1	Tank 300 L - Stainless steel
PAW-TA20C1E5STD	Tank 200 L - Enamelled
PAW-TA30C1E5STD	Tank 300 L - Enamelled
PAW-3WYVLV-HW	3 way valve for DHW tanks
CZ-NV1	3 way valve kit for inside of hydrokit for H and J Generations
PAW-BTANK50L-2	Buffer tank 50 L

Accessories	
CZ-TAW1B	Aquarea Smart Cloud for remote control and maintenance through wireless or wired LAN
CZ-TAW1-CBL	10 m extension cable for CZ-TAW1B
CZ-NS4P	Additional functions PCB
PAW-A2W-MGTFILTER	Magnet for the water filter
PAW-A2W-RTWIRED	Room thermostat
PAW-A2W-RTWIRELESS	Wireless LCD room thermostat



INTERNET CONTROL: Optional.

Aquarea T-CAP Bi-bloc H Generation Three phase. Super Quiet outdoor unit. Heating and Cooling - SQC - R410A

Energy efficiency: A+++ in heating at 35 °C / "A" water pump with variable speed / Built-in flow meter.

Flexibility: Optional magnet for the water filter.

Comfort: Low noise level / Constant capacity down to -20 °C / Operating range down to -28 °C / 60 °C water outlet temperature.

Control: Additional functions with optional PCB (2 zone control, bivalent control, Smart Grid contact and more).

Connectivity: Optional Aquarea Smart and Service Cloud and integration into BMS projects.



011-1W0510
011-1W0511

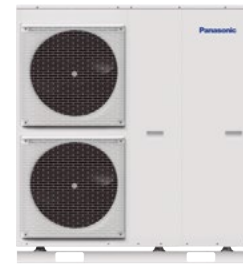

				Three phase (power to indoor)		
Kit			KIT-WQC09H3E8	KIT-WQC12H9E8	KIT-WQC16H9E8	
Heating capacity / COP (A +7 °C, W 35 °C)		kW / COP	9,00/4,84	12,00/4,74	16,00/4,28	
Heating capacity / COP (A +7 °C, W 55 °C)		kW / COP	9,00/2,94	12,00/2,88	16,00/2,71	
Heating capacity / COP (A +2 °C, W 35 °C)		kW / COP	9,00/3,59	12,00/3,44	16,00/3,10	
Heating capacity / COP (A +2 °C, W 55 °C)		kW / COP	9,00/2,21	12,00/2,19	16,00/2,13	
Heating capacity / COP (A -7 °C, W 35 °C)		kW / COP	9,00/2,85	12,00/2,72	16,00/2,49	
Heating capacity / COP (A -7 °C, W 55 °C)		kW / COP	9,00/2,02	12,00/1,92	16,00/1,86	
Cooling capacity / EER (A 35 °C, W 7 °C)		kW / EER	7,00/3,17	10,00/2,81	12,20/2,57	
Cooling capacity / EER (A 35 °C, W 18 °C)		kW / EER	7,00/5,19	10,00/5,13	12,20/3,49	
Heating average climate (W 35 °C / W 55 °C)		Seasonal energy efficiency SCOP (η _s %)	4,59/3,32(181/130)	4,32/3,32(170/130)	4,08/3,20(160/125)	
		Energy class	A+++ to D	A++/A++	A++/A++	
Heating warm climate (W 35 °C / W 55 °C)		Seasonal energy efficiency SCOP (η _s %)	5,95/4,02(235/158)	5,86/4,02(231/158)	5,86/4,05(231/159)	
		Energy class	A+++ to D	A+++/A+++	A+++/A+++	
Heating cold climate (W 35 °C / W 55 °C)		Seasonal energy efficiency SCOP (η _s %)	4,08/3,20(160/125)	4,08/3,20(160/125)	3,83/3,20(150/125)	
		Energy class	A+++ to D	A++/A++	A++/A++	
Indoor unit			WH-SQC09H3E8	WH-SQC12H9E8	WH-SQC16H9E8	
Sound pressure	Heat / Cool	dB(A)	33/33	33/33	33/33	
Dimension	HxWxD	mm	892x500x340	892x500x340	892x500x340	
Net weight		kg	43	44	45	
Water pipe connector		Inch	R 1½	R 1½	R 1½	
A class pump	Number of speeds		Variable Speed	Variable Speed	Variable Speed	
	Input power (Min/Max)	W	32/102	34/110	30/105	
Heating water flow (ΔT=5 K, 35 °C)		L/min	25,8	34,4	45,9	
Electric backup heater		kW	3,00	9,00	9,00	
Recommended fuse		A	15/30	15/30	15/30	
Recommended minimum cable size, supply 1 / 2 ¹⁾		mm ²	5x1,5/3x1,5	5x1,5/5x1,5	5x1,5/5x1,5	
Outdoor unit			WH-UQ09HE8	WH-UQ12HE8	WH-UQ16HE8	
Sound power ²⁾	Heat	dB(A)	58	58	62	
Dimension	HxWxD	mm	1410x1283x320	1410x1283x320	1410x1283x320	
Net weight		kg	151	151	161	
Refrigerant (R410A) / CO ₂ Eq.		kg / T	2,85/5,951	2,85/5,951	2,99/6,243	
Piping diameter	Liquid / Gas	Inch (mm)	3/8(9,52)/5/8(15,88)	3/8(9,52)/5/8(15,88)	3/8(9,52)/5/8(15,88)	
Pipe length range		m	3-30	3-30	3-30	
Elevation difference (in / out)		m	20	20	20	
Pre-charged pipe length		m	10	10	10	
Additional gas amount		g/m	50	50	50	
Operating range - outdoor ambient	Heat	°C	-28~+35	-28~+35	-28~+35	
	Cool	°C	+16~+43	+16~+43	+16~+43	
Water outlet	Heat / Cool	°C	20~60/5~20	20~60/5~20	20~60/5~20	

1) Check local regulations. 2) Sound power in accordance to 811/2013, 813/2013 and EN12102-1:2017 at +7 °C. * EER and COP calculation is based in accordance to EN14511.

Accessories	
PAW-TD20C1E5-1	Tank 200 L - Stainless steel
PAW-TD30C1E5-1	Tank 300 L - Stainless steel
PAW-TA20C1E5STD	Tank 200 L - Enamelled
PAW-TA30C1E5STD	Tank 300 L - Enamelled
PAW-3WVYLV-HW	3 way valve for DHW tanks
CZ-NV1	3 way valve kit for inside of hydrokit for H and J Generations
PAW-BTANK50L-2	Buffer tank 50 L

Accessories	
CZ-TAW1B	Aquarea Smart Cloud for remote control and maintenance through wireless or wired LAN
CZ-TAW1-CBL	10 m extension cable for CZ-TAW1B
CZ-NS4P	Additional functions PCB
PAW-A2W-MGTFILTER	Magnet for the water filter
PAW-A2W-RTWIRED	Room thermostat
PAW-A2W-RTWIRELESS	Wireless LCD room thermostat



INTERNET CONTROL: Optional.

Aquarea T-CAP Mono-bloc J Generation Single phase / Three phase. Heating and Cooling - MXC · R32

Energy efficiency: A+++ in heating at 35 °C / "A" water pump with variable speed / Built-in flow meter.

Flexibility: Built-in magnetic water filter.

Comfort: Constant capacity and operating range down to -20 °C / 65 °C water outlet temperature.

Control: Additional functions with optional PCB (2 zone control, bivalent control, Smart Grid contact and more).

Connectivity: Optional Aquarea Smart and Service Cloud and integration into BMS projects.

011-1W0463, 011-1W0464, 011-1W0562,
011-1W0563, 011-1W0564, 011-1W0565.
For 9 and 12 kW single and three phase.



Outdoor unit	Single phase			Three phase			
	WH-MXC09J3E5	WH-MXC12J6E5	WH-MXC09J3E8	WH-MXC12J9E8	WH-MXC16J9E8		
Heating capacity / COP (A +7 °C, W 35 °C)	kW / COP	9,00/5,08	12,00/4,80	9,00/5,08	12,00/4,80	16,00/4,52	
Heating capacity / COP (A +7 °C, W 55 °C)	kW / COP	9,00/3,08	12,00/3,05	9,00/3,08	12,00/3,05	16,00/2,86	
Heating capacity / COP (A +2 °C, W 35 °C)	kW / COP	9,00/3,81	12,00/3,53	9,00/3,81	12,00/3,53	16,00/3,10	
Heating capacity / COP (A +2 °C, W 55 °C)	kW / COP	9,00/2,54	12,00/2,42	9,00/2,54	12,00/2,42	16,00/2,07	
Heating capacity / COP (A -7 °C, W 35 °C)	kW / COP	9,00/3,08	12,00/2,82	9,00/3,08	12,00/2,82	16,00/2,39	
Heating capacity / COP (A -7 °C, W 55 °C)	kW / COP	9,00/2,12	12,00/2,00	9,00/2,12	12,00/2,00	16,00/1,71	
Cooling capacity / EER (A 35 °C, W 7 °C)	kW / EER	9,00/3,18	12,00/2,90	9,00/3,09	12,00/2,84	14,50/2,84	
Cooling capacity / EER (A 35 °C, W 18 °C)	kW / EER	9,00/4,62	12,00/3,95	9,00/4,46	12,00/3,79	16,00/3,75	
Heating average climate (W 35 °C / W 55 °C)	Seasonal energy efficiency	SCOP (η _s %)	4,96/3,57(195/140)	4,96/3,57(195/140)	4,96/3,57(195/140)	4,96/3,57(195/140)	4,46/3,31(176/129)
	Energy class	A+++ to D	A+++/A++	A+++/A++	A+++/A++	A+++/A++	A+++/A++
Heating warm climate (W 35 °C / W 55 °C)	Seasonal energy efficiency	SCOP (η _s %)	6,47/4,34(256/171)	6,47/4,34(256/171)	6,47/4,34(256/171)	6,47/4,34(256/171)	5,88/4,09(232/160)
	Energy class	A+++ to D	A+++/A+++	A+++/A+++	A+++/A+++	A+++/A+++	A+++/A+++
Heating cold climate (W 35 °C / W 55 °C)	Seasonal energy efficiency	SCOP (η _s %)	4,31/3,26(169/127)	4,31/3,26(169/127)	4,31/3,26(169/127)	4,31/3,26(169/127)	3,83/3,20(150/125)
	Energy class	A+++ to D	A++/A++	A++/A++	A++/A++	A++/A++	A++/A++
Sound power ¹⁾	Heat	dB(A)	65	65	65	65	66
Dimension	HxWxD	mm	1410x1283x320	1410x1283x320	1410x1283x320	1410x1283x320	1410x1283x320
Net weight		kg	140	140	140	140	150
Refrigerant (R32) / CO ₂ Eq. ²⁾		kg / T	1,60/1,080	1,60/1,080	1,60/1,080	1,60/1,080	1,80/1,215
Water pipe connector		Inch	R 1¼	R 1¼	R 1¼	R 1¼	R 1¼
Pump	Number of speeds		Variable Speed	Variable Speed	Variable Speed	Variable Speed	Variable Speed
	Input power (Min/Max)	W	32/173	34/173	32/173	34/173	38/173
Heating water flow (ΔT=5 K, 35 °C)		L/min	25,8	34,4	25,8	34,4	45,9
Electric backup heater		kW	3,00	6,00	3,00	9,00	9,00
Input power	Heat	kW	1,77	2,50	1,77	2,50	3,54
	Cool	kW	2,83	4,14	2,91	4,23	5,11
Running and starting current	Heat	A	8,3	11,6	2,6	3,7	5,3
	Cool	A	13,1	19,1	4,3	6,3	7,6
Current 1		A	29,0	29,0	14,7	11,8	16,4
Current 2		A	13,0	26,0	13,0	13,0	13,0
Recommended fuse, supply 1 / 2		A	30/30	30/30	20/16	20/20	20/20
Recommended minimum cable size, supply 1 / 2 ³⁾		mm ²	3x4,0 or 6,0/3x4,0	3x4,0 or 6,0/3x4,0	5x1,5/3x1,5	5x1,5/5x1,5	5x2,5/5x1,5
Operating range - outdoor ambient	Heat	°C	-20 ~ +35	-20 ~ +35	-20 ~ +35	-20 ~ +35	-20 ~ +35
	Cool	°C	10 ~ +43	10 ~ +43	10 ~ +43	10 ~ +43	10 ~ +43
Water outlet ⁴⁾	Heat	°C	20 ~ 65	20 ~ 65	20 ~ 65	20 ~ 65	20 ~ 65
	Cool	°C	5 ~ 20	5 ~ 20	5 ~ 20	5 ~ 20	5 ~ 20

1) Sound power in accordance to 811/2013, 813/2013 and EN12102-1:2017 at +7 °C. 2) WH-MXC models are hermetically sealed. 3) Check local regulations. 4) It is possible to set temperature by 65 °C on remote controller. Normally, outlet water temperature is 60 °C or lower. In case of ΔT setting with remote controller is 15 °C and the outdoor ambient temperature is 5 to 20 °C, outlet water temperature 65 °C is possible. * EER and COP calculation is based in accordance to EN14511.

Accessories

PAW-TD20C1E5-1	Tank 200 L - Stainless steel
PAW-TD30C1E5-1	Tank 300 L - Stainless steel
PAW-TA20C1E5STD	Tank 200 L - Enamelled
PAW-TA30C1E5STD	Tank 300 L - Enamelled
PAW-TD20B8E3-2	Combo Tank 185 L + 80 L - Enamelled
PAW-TD23B6E5	Combo Tank 230 L + 60 L - Stainless Steel
PAW-3WYVHV-HW	3 way valve for DHW tanks
PAW-BTANK50L-2	Buffer tank 50 L

Accessories

CZ-TAW1B	Aquarea Smart Cloud for remote control and maintenance through wireless or wired LAN
CZ-TAW1-CBL	10 m extension cable for CZ-TAW1B
PAW-A2W-AFVLV	1 anti-freeze valve. It is required to order 2 valves per system
PAW-A2W-RTWIRED	Room thermostat
PAW-A2W-RTWIRELESS	Wireless LCD room thermostat



INTERNET CONTROL: Optional.

Aquarea HT Bi-bloc F Generation Single phase / Three phase. Heating Only - SHF - R407C

Energy efficiency: "A" water pump with variable speed.

Comfort: Operating range down to -20 °C outdoor temperature / 65 °C water outlet temperature



Kit	Single phase (power to indoor)			Three phase (power to indoor)		
		KIT-WHF09F3E5	KIT-WHF12F6E5	KIT-WHF09F3E8	KIT-WHF12F9E8	
Heating capacity / COP (A +7 °C, W 35 °C)	kW / COP	9,00/4,64	12,00/4,46	9,00/4,64	12,00/4,46	
Heating capacity / COP (A +7 °C, W 65 °C)	kW / COP	9,00/2,48	12,00/2,41	9,00/2,48	12,00/2,41	
Heating capacity / COP (A +2 °C, W 35 °C)	kW / COP	9,00/3,45	12,00/3,26	9,00/3,45	12,00/3,26	
Heating capacity / COP (A +2 °C, W 65 °C)	kW / COP	9,00/2,06	10,30/2,01	9,00/2,06	10,30/2,01	
Heating capacity / COP (A -7 °C, W 35 °C)	kW / COP	9,00/2,74	12,00/2,52	9,00/2,74	12,00/2,52	
Heating capacity / COP (A -7 °C, W 65 °C)	kW / COP	9,00/1,79	9,60/1,77	9,00/1,79	9,60/1,77	
Heating average climate (W 35 °C / W 55 °C)	Seasonal energy efficiency	SCOP (η _s %)	3,90/3,20(153/125)	3,82/3,21(150/125)	3,90/3,20(153/125)	3,82/3,21(150/125)
	Energy class		A+++ to D	A++/A++	A++/A++	A++/A++
Heating warm climate (W 35 °C / W 55 °C)	Seasonal energy efficiency	SCOP (η _s %)	4,84/3,97(191/156)	4,77/3,97(188/156)	4,84/3,97(191/156)	4,77/3,97(188/156)
	Energy class		A+++ to D	A+++/A+++	A+++/A+++	A+++/A+++
Heating cold climate (W 35 °C / W 55 °C)	Seasonal energy efficiency	SCOP (η _s %)	3,50/2,97(137/116)	3,42/2,90(134/113)	3,50/2,97(137/116)	3,42/2,90(134/113)
	Energy class		A+++ to D	A+/A+	A+/A+	A+/A+
Indoor unit		WH-SHF09F3E5	WH-SHF12F6E5	WH-SHF09F3E8	WH-SHF12F9E8	
Sound pressure						
Dimension	H x W x D	mm	892 x 502 x 353	892 x 502 x 353	892 x 502 x 353	
Net weight		kg	46	47	47	
Water pipe connector		Inch	R 1½	R 1½	R 1½	
A class pump	Number of speeds		7	7	7	
	Input power (Min/Max)	W	38/100	40/106	38/100	40/106
Heating water flow (ΔT=5 K, 35 °C)		L/min	25,8	34,4	25,8	34,4
Electric backup heater		kW	3,00	6,00	3,00	9,00
Recommended fuse		A	30/30	30/30	30/16	30/16
Recommended minimum cable size, supply 1 / 2 ¹⁾		mm ²	3 x 4,0 or 6,0 / 3 x 4,0	3 x 4,0 or 6,0 / 3 x 4,0	5 x 1,5 / 3 x 1,5	5 x 1,5 / 5 x 1,5
Outdoor unit		WH-UH09FE5	WH-UH12FE5	WH-UH09FE8	WH-UH12FE8	
Sound power ²⁾						
Dimension	H x W x D	mm	1340 x 900 x 320	1340 x 900 x 320	1340 x 900 x 320	
Net weight		kg	104	104	110	110
Refrigerant (R407C) / CO ₂ Eq.		kg / T	2,90/5,145	2,90/5,145	2,90/5,145	2,90/5,145
Piping diameter	Liquid / Gas	Inch (mm)	3/8(9,52)/5/8(15,88)	3/8(9,52)/5/8(15,88)	3/8(9,52)/5/8(15,88)	3/8(9,52)/5/8(15,88)
Pipe length range		m	3-30	3-30	3-30	3-30
Elevation difference (in / out)		m	20	20	20	20
Pre-charged pipe length		m	10	10	10	10
Additional gas amount		g/m	70	70	70	70
Operating range	Outdoor ambient (Heat)	°C	-20 ~ +35	-20 ~ +35	-20 ~ +35	-20 ~ +35
Water outlet	Heat	°C	25 ~ 65	25 ~ 65	25 ~ 65	25 ~ 65

1) Check local regulations. 2) Sound power in accordance to 811/2013, 813/2013 and EN12102-1:2017 at +7 °C. * EER and COP calculation is based in accordance to EN14511.

Accessories	
PAW-TD20C1E5-1	Tank 200 L - Stainless steel
PAW-TD30C1E5-1	Tank 300 L - Stainless steel
PAW-TA20C1E5STD	Tank 200 L - Enamelled
PAW-TA30C1E5STD	Tank 300 L - Enamelled

Accessories	
PAW-3WYVLV-HW	3 way valve for DHW tanks
PAW-BTANK50L-2	Buffer tank 50 L
PAW-A2W-RTWIRED	Room thermostat
PAW-A2W-RTWIRELESS	Wireless LCD room thermostat



Aquarea HT Mono-bloc G Generation Single phase. Heating Only - MHF · R407C

Energy efficiency: "A" water pump with variable speed.

Comfort: Operating range down to -20 °C outdoor temperature / 65 °C water outlet temperature



Single phase

Outdoor unit			WH-MHF09G3E5	WH-MHF12G6E5
Heating capacity / COP (A +7 °C, W 35 °C)		kW / COP	9,00/4,64	12,00/4,46
Heating capacity / COP (A +7 °C, W 65 °C)		kW / COP	9,00/2,48	12,00/2,41
Heating capacity / COP (A +2 °C, W 35 °C)		kW / COP	9,00/3,45	12,00/3,26
Heating capacity / COP (A +2 °C, W 65 °C)		kW / COP	9,00/2,06	10,30/2,01
Heating capacity / COP (A -7 °C, W 35 °C)		kW / COP	9,00/2,74	12,00/2,52
Heating capacity / COP (A -7 °C, W 65 °C)		kW / COP	9,00/1,79	9,60/1,77
Heating average climate (W 35 °C / W 55 °C)	Seasonal energy efficiency	SCOP (η _s %)	3,90/3,20(153/125)	3,82/3,21(150/125)
	Energy class	A+++ to D	A++/A++	A++/A++
Heating warm climate (W 35 °C / W 55 °C)	Seasonal energy efficiency	SCOP (η _s %)	4,84/3,97(191/156)	4,77/3,97(188/156)
	Energy class	A+++ to D	A+++/A+++	A+++/A+++
Heating cold climate (W 35 °C / W 55 °C)	Seasonal energy efficiency	SCOP (η _s %)	3,50/2,97(137/116)	3,42/2,90(134/113)
	Energy class	A+++ to D	A+/A+	A+/A+
Sound power ¹⁾		dB(A)	—	—
Dimension	HxWxD	mm	1410x1283x320	1410x1283x320
Net weight		kg	151	151
Refrigerant (R407C) / CO ₂ Eq. ²⁾		kg / T	1,92/3,406	1,92/3,406
Water pipe connector		Inch	R1½	R1½
Pump	Number of speeds		7	7
	Input power (Min/Max)	W	—	—
Heating water flow (ΔT=5 K, 35 °C)		L/min	25,8	34,4
Electric backup heater		kW	3,00	6,00
Input power		kW	1,94	2,69
Running and starting current		A	9,3	12,8
Current 1		A	28,5	29,0
Current 2		A	13,0	26,0
Recommended fuse		A	30/30	30/30
Recommended minimum cable size, supply 1 / 2 ³⁾		mm ²	3x4,0 or 6,0/3x4,0	3x4,0 or 6,0/3x4,0
Operating range	Outdoor ambient (Heat)	°C	-20 ~ +35	-20 ~ +35
Water outlet	Heat	°C	25 ~ 65	25 ~ 65

1) Sound power in accordance to 811/2013, 813/2013 and EN12102-1:2017 at +7 °C. 2) WH-MHF models are hermetically sealed. 3) Check local regulations. * EER and COP calculation is based in accordance to EN14511.

Accessories

PAW-TD20C1E5-1	Tank 200 L - Stainless steel
PAW-TD30C1E5-1	Tank 300 L - Stainless steel
PAW-TA20C1E5STD	Tank 200 L - Enamelled
PAW-TA30C1E5STD	Tank 300 L - Enamelled
PAW-TD20B8E3-2	Combo Tank 185 L + 80 L - Enamelled
PAW-TD23B6E5	Combo Tank 230 L + 60 L - Stainless Steel

Accessories

PAW-3WYVLV-HW	3 way valve for DHW tanks
PAW-BTANK50L-2	Buffer tank 50 L
PAW-A2W-AFVLV	1 anti-freeze valve. It is required to order 2 valves per system
PAW-A2W-RTWIRED	Room thermostat
PAW-A2W-RTWIRELESS	Wireless LCD room thermostat



Fan coils highlighted features

+ MORE FAN COIL OPTIONS IN CHILLERS SECTION

Available in a wide range of designs, the fan coils are perfectly adapted to fit within almost any location.



1 Innovation for an optimum comfort

Range of fan coils for heating and cooling with capacities from 0,2 to 9,6 kW in cooling and from 0,2 to 13,6 kW in heating. Bring full year comfort with hydronic systems.

3 Quality and efficient coil

Constructed from staggered copper tubes, mechanically expanded into aluminium fins, providing maximum heat transfer efficiency, durability and hygiene.

2 Energy efficient and low noise fan

Dynamically balanced and specially designed fans, reinforced acoustic insulation and optimised fan speed staging for lower noise levels. Improved efficiency with optional EC fan motor.

4 Flexible installation

Various types of unit to fit your needs with flexible installation options. A choice of service side for hydraulic connections, piping configuration and horizontal or vertical installation for ducted units.

Offering a great range of capacities and performance, available in a wide range of designs, the fan coils are perfectly adapted to fit within almost any location. Whether the requirements are for cooling only, or for both heating and cooling, there is a fan coil to suit. With a variety of piping and fan configuration, the range is capable of meeting the most stringent of requirements. Line up available in AC and EC fans, it is possible to achieve both powerful performance, but with sustainability in mind.

Controllers with sophisticated designs, provide a user friendly interface while enabling an easy and low cost integration to building management systems.

Optional wired remote controller for AC fan, 2-pipe and 4-pipe application.



PAW-FC-RC1

Optional wired remote controller for AC fan 2-pipe application.



PAW-FC-903AC



PAW-FC-907AC

Optional wired remote controller for EC fan, 2-pipe and 4-pipe application.



PAW-FC-903EC



PAW-FC-907EC

Smart fan coils



Built-in advanced thermostat.

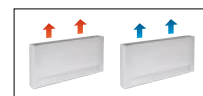

		PAW-AAIR-200-2	PAW-AAIR-700-2	PAW-AAIR-900-2	NEW PAW-AAIR-1100-2
Total cooling capacity	Lo/Med/Hi kW	0,3/0,5/0,6	0,6/0,9/1,5	0,8/1,6/2,1	0,9/1,8/2,5
Sensible capacity	Lo/Med/Hi kW	0,2/0,4/0,6	0,5/0,9/1,3	0,7/1,3/1,9	0,9/1,6/2,3
Water flow	Lo/Med/Hi kg/h	51,1/89,4/106,3	96,0/155,2/251,1	140,8/267,2/365,7	158,1/300,3/423,6
Water pressure drop	Lo/Med/Hi kPa	3,3/5,7/6,1	1,1/2,1/4,2	1,5/5,8/10,3	1,3/5,0/10,6
Inlet water temperature	°C	10	10	10	10
Outlet water temperature	°C	15	15	15	15
Inlet air temperature	°C	27	27	27	27
Outlet air temperature	Lo/Med/Hi °C	12,8/13,2/14,9	14,6/14,8/14,0	15,8/14,6/14,4	18,1/15,2/14,7
Relative humidity of inlet air	%	47	47	47	47
Total heating capacity	Lo/Med/Hi kW	0,2/0,4/0,5	0,4/0,8/1,2	0,6/1,2/1,6	0,8/1,4/2,1
Water flow	Lo/Med/Hi kg/h	38,4/70,5/92,8	72,7/139,2/201,6	114,0/204,2/284,5	138,3/243,2/356,7
Water pressure drop	Lo/Med/Hi kPa	1,0/2,3/3,0	0,5/1,5/3,1	1,0/3,3/6,6	1,1/3,1/7,3
Inlet water temperature	°C	35	35	35	35
Outlet water temperature	°C	30	30	30	30
Inlet air temperature	°C	19	19	19	19
Outlet air temperature	Lo/Med/Hi °C	33,5/33,3/30,9	30,1/31,4/31,8	30,1/31,1/31,2	26,6/29,5/30,5
Air flow	Lo/Med/Hi m ³ /min	0,9/1,9/2,7	2,6/4,2/5,3	4,1/6,1/7,7	6,2/7,6/9,6
Maximum input power	Lo/Med/Hi W	7,0/9,0/13,0	14,0/18,0/22,0	16,0/20,0/24,0	18,0/22,0/26,5
Sound pressure	Lo/Med/Hi dB(A)	24/33/39	25/34/40	25/34/42	26/35/43
Dimension (HxWxD)	mm	735x579x129	935x579x129	1135x579x129	1335x579x129
Net weight	kg	17	20	23	26
3 Ways valve included		Yes	Yes	Yes	Yes
Touch screen thermostat		Yes	Yes	Yes	Yes

* Smart fan coils is produced by Innova.

Accessories	
PAW-AAIR-LEGS-1	Kits of 2 legs to protect the water pipings

Accessories	
PAW-AAIR-RHCABLE	Motor connection cable for units with hydraulic connections on the right

Stylish floor-standing fan coils with advanced controller

The slimline of Smart fan coils delivers high efficiency climate control.

With a depth of just under 130 mm they are at the cutting edge of the market. Blending easily into the home, Smart fan coil's elegant design and product refinements are clear to see in every detail.

Exceptional ventilation efficiency means the motor uses considerably less energy (low wattage). The fan speed is continuously modulated by the temperature controller with proportional integral logic, with undoubted advantages for regulating the temperature and humidity in summer mode.

Technical focus

- 4 operation modes (auto, silent, night-time and maximum ventilation speed)
- Exclusive design
- Extremely compact (only 129 mm deep)
- Cooling and dehumidification functions possible (drain is needed)
- 3-way valve included (no overflow valve needed on the installation if more than 3 units installed)
- Touch screen thermostat

With standard cast radiators.

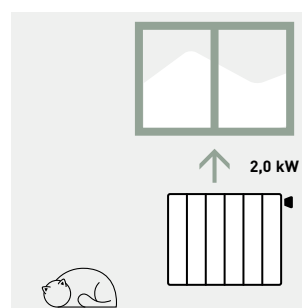

Water at 65 °C needed.

With Smart fan coil.

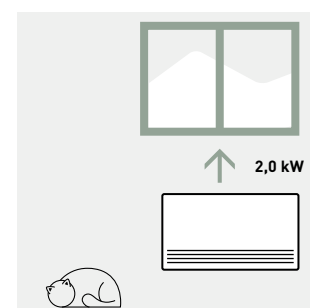

Water at 35 °C needed.

All temperature curves and capacity are available on www.panasonicproclub.com

PRO Club



Fan coils - ducted (AC)



Optional controller.
Advanced wired remote
controller.
PAW-FC-RC1



Optional controller.
Wired remote controller
with touch control.
PAW-FC-907AC



Optional controller.
Wired remote controller.
PAW-FC-903AC



Left connection (PAW-)			FC2A-D010L	FC2A-D020L	FC2A-D030L	FC2A-D040L	FC2A-D050L	FC2A-D060L	FC2A-D070L	FC2A-D080L
Right connection (PAW-)			FC2A-D010R	FC2A-D020R	FC2A-D030R	FC2A-D040R	FC2A-D050R	FC2A-D060R	FC2A-D070R	FC2A-D080R
Total cooling capacity ¹⁾	Lo/Med/Hi	kW	0,7/1,0/1,5	0,7/1,2/1,7	1,0/2,0/2,5	1,2/2,4/3,2	1,7/3,2/4,6	2,7/4,6/5,8	3,4/6,1/7,3	4,6/6,1/8,1
Sensible capacity ¹⁾	Lo/Med/Hi	kW	0,5/0,8/1,1	0,6/0,9/1,3	0,8/1,5/1,9	0,9/1,8/2,3	1,2/2,2/3,3	1,9/3,3/4,5	2,4/4,3/5,1	3,4/4,6/6,3
Water flow	Lo/Med/Hi	l/h	124/172/250	127/213/289	172/341/430	206/413/547	296/544/798	466/784/1003	587/1058/1252	798/1048/1400
Water pressure drop	Lo/Med/Hi	kPa	10,7/19,5/39,2	1,9/3,9/6,3	6,3/19,3/28,8	5,4/17,1/28,0	7,5/22,8/46,9	13,9/37,4/60,2	4,8/15,4/21,5	11,9/19,3/32,5
Heating capacity ²⁾	Lo/Med/Hi	kW	0,9/1,4/2,0	0,9/1,5/2,2	1,3/2,4/3,1	1,4/2,9/4,0	2,1/4,1/5,7	3,1/5,3/7,1	4,3/7,9/9,3	5,9/8,1/11,6
Sound levels										
Global sound power	Lo/Med/Hi	dB(A)	33/40/49	31/43/50	30/45/52	30/44/51	34/46/56	38/51/58	43/56/61	50/55/64
Global sound pressure ³⁾	Lo/Med/Hi	dB(A)	24/31/40	22/34/41	21/36/43	21/35/42	25/37/47	29/42/49	34/47/52	41/46/55
Fan										
Number			1	1	1	2	2	2	2	3
Air flow	Lo/Med/Hi	m ³ /h	111/190/283	105/179/265	138/274/390	173/357/499	253/486/716	350/640/933	480/893/1064	660/936/1397
External pressure	Max	Pa	55	55	65	85	85	115	125	70
Filter			G2	G2	G2	G2	G2	G2	G2	G2
Electrical data										
Power supply	Voltage	V	230	230	230	230	230	230	230	230
	Phase		Single phase	Single phase	Single phase	Single phase	Single phase	Single phase	Single phase	Single phase
	Frequency	Hz	50/60	50/60	50/60	50/60	50/60	50/60	50/60	50/60
Consumption	Lo/Med/Hi	W	13/24/36	10/18/29	16/37/45	15/37/56	28/55/72	37/75/105	53/100/147	90/112/188
Water connections										
Type			Female gas threaded	Female gas threaded	Female gas threaded	Female gas threaded	Female gas threaded	Female gas threaded	Female gas threaded	Female gas threaded
Water connections	Inch		1/2	1/2	1/2	1/2	1/2	1/2	3/4	3/4
Dimension and weight										
Dimension	HxWxD	mm	220x570x430	220x570x430	220x730x430	220x938x430	220x1122x430	220x1307x430	220x1121x530	220x1316x530
Weight		kg	13	13	15	20	22	26	27	38

1) According to Eurovent standard. Air: 27 °C DB / 19 °C WB. Water in / out: 7 °C / 12 °C. 2) Air: 20 °C. Water in / out: 50 °C / 45 °C. 3) The sound pressure levels are based on (INR) characteristics of a room having volume of 100 m³ with reverberation of 0,5 seconds.

Values indicated are for 0 Pa external static pressure, for additional pressure characteristics, please refer the selection software. * Fan coil units are produced by Systemair.

Accessories

PAW-FC-RC1	Advanced wired remote controller
PAW-FC-907AC	Wired remote controller with touch control
PAW-FC-903AC	Wired remote controller
PAW-FC-2WY-11/55-1	2 way valve + drain pan for models 010-060

Accessories

PAW-FC-2WY-65/90-1	2 way valve + drain pan for models 070-080
PAW-FC-3WY-11/55-1	3 way valve + drain pan for models 010-060
PAW-FC-3WY-65/90-1	3 way valve + drain pan for models 070-080

Technical focus

- Cooling capacity: 0,7 to 8,1 kW
- Heating capacity: 0,7 to 10,3 kW
- 5-speed AC fan motor(s)

Main features and accessories

- Left or right hand arrangements
- Ease of installation
- Very low acoustic levels
- 2 way or 3 way ON / OFF valves
- Auxiliary drain pan
- Air intake with removable grid
- G2 filter

Operating limits

Entering water temperature	From 5 to 90 °C
Indoor air temperature	From 5 to 32 °C



Fan coils - ducted (EC)



Optional controller.
Wired remote controller
with touch control.
PAW-FC-907EC



Optional controller.
Wired remote controller.
PAW-FC-903EC

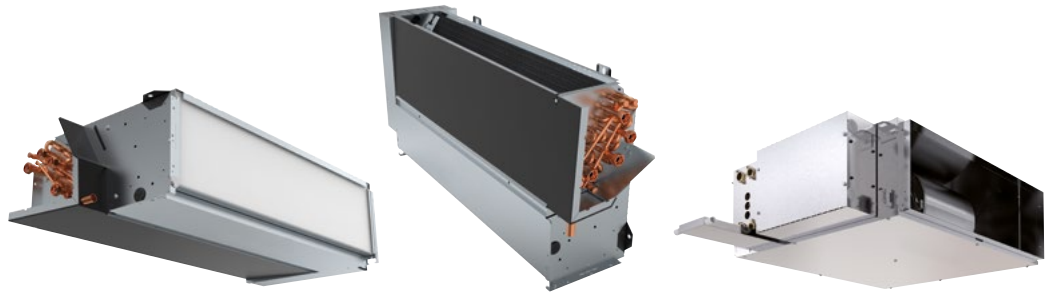

Left connection (PAW-)		FC2E-D010L	FC2E-D020L	FC2E-D030L	FC2E-D040L	FC2E-D050L	FC2E-D060L	FC2E-D070L	FC2E-D080L	FC2E-F040L	
Right connection (PAW-)		FC2E-D010R	FC2E-D020R	FC2E-D030R	FC2E-D040R	FC2E-D050R	FC2E-D060R	FC2E-D070R	FC2E-D080R	FC2E-F040R	
Total cooling capacity ¹⁾	Lo/Med/Hi	kW	0,6/1,2/2,1	0,6/1,4/2,4	0,9/2,1/3,1	1,3/2,9/4,2	1,3/4,0/5,0	2,0/4,5/5,2	2,7/5,9/6,9	5,1/6,5/8,8	3,6/6,6/9,2
Sensible capacity ¹⁾	Lo/Med/Hi	kW	0,5/1,1/1,9	0,5/1,1/1,9	0,6/1,6/2,4	1,0/2,1/3,0	1,1/3,0/3,7	1,4/3,5/4,0	2,0/4,3/5,2	3,7/4,8/6,6	2,9/6,1/9,1
Water flow	Lo/Med/Hi	l/h	107/210/356	110/237/406	148/354/532	230/506/722	231/685/743	341/767/800	463/1008/1098	879/1111/1254	627/1142/1575
Water pressure drop	Lo/Med/Hi	kPa	8,2/28,2/76,9	1,5/4,6/11,0	5,0/20,5/42,1	6,4/24,4/46,3	4,9/35,1/41,0	7,8/35,8/38,8	3,0/14,0/16,6	14,1/21,4/26,6	10,6/51,2/93,8
Heating capacity ²⁾	Lo/Med/Hi	kW	0,8/1,6/2,9	0,9/1,9/3,3	1,0/2,2/3,4	1,4/3,0/5,3	1,7/5,2/5,5	2,3/5,9/6,1	3,8/7,3/8,2	6,2/8,0/9,3	4,4/8,3/11,8
Sound levels											
Global sound power	Lo/Med/Hi	dB(A)	34/47/60	34/47/60	31/50/59	29/44/52	30/51/57	32/54/58	40/54/59	51/56/64	42/58/68 ³⁾
Global sound pressure ⁴⁾	Lo/Med/Hi	dB(A)	25/38/51	25/38/51	22/41/50	20/35/43	21/42/48	23/45/49	31/45/50	42/47/55	23/39/52
Fan											
Number			1	1	1	2	2	2	2	3	1
Air flow	Lo/Med/Hi	m ³ /h	108/228/417	98/234/413	145/380/585	170/412/678	203/645/816	245/737/912	350/850/1050	685/927/1398	592/1284/1935
External pressure	Max	Pa	75	75	75	105	70	105	115	70	190
Filter			G2	G2	G2	G2	G2	G2	G2	G2	G2
Electrical data											
Power supply	Voltage	V	230	230	230	230	230	230	230	230	230
	Phase		Single phase	Single phase	Single phase	Single phase	Single phase	Single phase	Single phase	Single phase	Single phase
	Frequency	Hz	50/60	50/60	50/60	50/60	50/60	50/60	50/60	50/60	50/60
Consumption	Lo/Med/Hi	W	5/11/41	5/13/41	4/16/42	2/13/43	4/24/46	2/30/54	11/44/77	23/42/108	11/62/197
Water connections											
Type			Female gas threaded	Female gas threaded	Female gas threaded	Female gas threaded	Female gas threaded	Female gas threaded	Female gas threaded	Female gas threaded	Female gas threaded
Water connections	Inch		1/2	1/2	1/2	1/2	1/2	1/2	3/4	3/4	3/4
Dimension and weight											
Dimension	H x W x D	mm	220x570x430	220x570x430	220x730x430	220x938x430	220x1122x430	220x1307x430	220x1121x530	220x1316x530	223x1233x653
Weight		kg	13	13	15	20	22	26	27	38	19

1) According to Eurovent standard. Air: 27 °C DB / 19 °C WB. Water in / out: 7 °C / 12 °C. 2) Air: 20 °C. Water in / out: 50 °C / 45 °C. 3) The sound power levels indicated are from return and radiated measurements. 4) The sound pressure levels are based on (NR) characteristics of a room having volume of 100 m³ with reverberation of 0,5 seconds.

Values indicated are for 0 Pa external static pressure, for additional pressure characteristics, please refer the selection software. * Fan coil units are produced by Systemair.

Accessories

PAW-FC-907EC	Wired remote controller with touch control
PAW-FC-903EC	Wired remote controller
PAW-FC-2WY-11/55-1	2 way valve + drain pan for models 010-060
PAW-FC-2WY-65/90-1	2 way valve + drain pan for models 070-080

Accessories

PAW-FC-2WY-F040	2 way valve + drain pan for model F040
PAW-FC-3WY-11/55-1	3 way valve + drain pan for models 010-060
PAW-FC-3WY-65/90-1	3 way valve + drain pan for models 070-080
PAW-FC-3WY-F040	3 way valve + drain pan for model F040

Technical focus

- Cooling capacity: 0,5 to 9,6 kW
- Heating capacity: 0,6 to 13,6 kW
- Low energy consumption EC fan(s)

Main features and accessories

- Left or right hand arrangements
- Can be installed both horizontally and vertically*
- Ease of installation
- Very low acoustic levels
- 2 way or 3 way ON / OFF valves
- Auxiliary drain pan
- Air intake with removable grid
- G2 filter

Operating limits

Entering water temperature	From 5 to 90 °C
Indoor air temperature	From 5 to 32 °C

* PAW-FC2E-F040 may only be installed horizontally.



Fan coils - wall-mounted (AC)



Optional controller.
Advanced wired remote
controller.
PAW-FC-RC1



Optional controller.
Wired remote controller
with touch control.
PAW-FC-907AC



Optional controller.
Wired remote controller.
PAW-FC-903AC



Infrared remote supplied
with IR versions.
IR Controller



2-pipe			PAW-FC2A-K007	PAW-FC2A-K009	PAW-FC2A-K018	PAW-FC2A-K022
			PAW-FC2A-K007IR	PAW-FC2A-K009IR	PAW-FC2A-K018IR	PAW-FC2A-K022IR
Total cooling capacity ¹⁾	Lo/Med/Hi	kW	1,0/1,3/1,7	1,6/1,7/2,4	2,8/3,0/3,5	2,9/3,1/3,9
Sensible capacity ¹⁾	Lo/Med/Hi	kW	0,7/1,0/1,2	1,2/1,3/1,9	2,1/2,3/2,7	2,3/2,5/3,1
Water flow	Lo/Med/Hi	l/h	172/231/287	270/291/418	483/508/609	502/535/669
Water pressure drop	Lo/Med/Hi	kPa	18,6/24,9/30,9	18,5/27,0/40,0	34,6/41,3/55,6	37,2/33,7/45,2
Heating capacity ²⁾	Lo/Med/Hi	kW	1,4/1,7/2,0	1,7/2,0/2,7	2,9/3,2/4,0	3,1/3,7/4,4
Sound levels						
Sound power	Lo/Med/Hi	dB(A)	45/49/51	47/52/57	49/53/59	56/59/63
Sound pressure ³⁾	Lo/Med/Hi	dB(A)	32/36/38	34/39/44	40/43/46	43/46/50
Fan						
Number			1	1	1	1
Air flow	Lo/Med/Hi	m ³ /h	282/321/360	367/413/551	532/592/680	617/709/850
Filter			G1	G1	G1	G1
Electrical data						
Power supply	Voltage	V	230	230	230	230
	Phase		Single phase	Single phase	Single phase	Single phase
	Frequency	Hz	50	50	50	50
Fuse rating		A	3	3	3	3
Consumption	Lo/Med/Hi	W	39/42/62	30/47/59	44/50/55	50/55/70
Water connections						
Type			Female gas threaded	Female gas threaded	Female gas threaded	Female gas threaded
Water connections	Inch		1/2	1/2	1/2	1/2
Dimension and weight						
Dimension	HxWxD	mm	275 x 180 x 845	275 x 180 x 845	298 x 200 x 940	298 x 200 x 940
Weight		kg	11	11	13	13

1) According to Eurovent standard. Air: 27 °C DB / 19 °C WB. Water in / out: 7 °C / 12 °C. 2) According to Eurovent standard. Air: 20 °C. Water in / out: 45 °C / 40 °C. 3) Sound pressure considering a local of 100 m³ a reverberation time of 0,5 seconds and a distance of 1 m.

Accessories

PAW-FC-RC1	Advanced wired remote controller
PAW-FC-907AC	Wired remote controller with touch control
PAW-FC-903AC	Wired remote controller

Accessories

PAW-FC2-2WY-K007	2 way valve
PAW-FC2-3WY-K007	3 way valve

Technical focus

- 4 sizes
- Cooling capacity: 1,0 to 3,9 kW
- Heating capacity: 1,4 to 4,1 kW
- Version: 2-pipes, AC fan

Main features and accessories

- 2 way or 3 way valve ON / OFF
- 3-speed AC fan motor
- Silent unit for optimum customer comfort
- Aesthetic design suitable for residential and hotel applications
- Compatible with IR controller (supplied with IR versions)
- Coil with hydrophilic fins to improve the condensate flow

* The electric movement of the flaps is available for the IR version.

Operating limits

Entering water temperature	From 5 to 60 °C
Indoor air temperature	From 6 to 40 °C



Wired controllers for AC and EC fan coils

Advanced wired remote controller (AC)

PAW-FC-RC1

This advanced controller provides a higher level of comfort in heating. The sensor can be used as a water flow sensor, stopping the fan when the water temperature is low, avoiding cold drafts in winter.

Features:

- For 2-pipe and 4-pipe, AC fan
- Change Over function (cold draft prevention)
- Room thermostat
- 3 outputs, 230 V relays for fan control
- 2 outputs, 230 V relays for heating / cooling control
- Connection to BMS - Modbus RTU slave
- 1 DI for presence detection (key card switch)
- 1 AI for sensor



Wired remote controller (AC/EC)

Stylish and sophisticated design with backlit LCD display, is suitable for installation within a wide variety of locations such as office, hotel and residential applications. By connecting the controller to the range of AC/EC fan coils, the user can take advantage of the improved performance, higher levels of efficiency and thus improved energy savings.

PAW-FC-907AC

Features:

- For 2-pipe, AC fan
- Back lit LCD screen with touch control
- 3 speed control relay, for fan
- Economizer

PAW-FC-907EC

Features:

- For 2-pipe and 4-pipe, EC fan
- Back lit LCD screen with touch control
- Adjustable range EC fan control
- Economizer
- Connection to BMS via Modbus
- 1 DI for presence detection (key card switch)



Wired remote controller (AC/EC)

Feature rich and perfectly adapted to control AC/EC fan coils, the PAW-FC-903AC/EC is the addition for any fan coil. With intuitive user interface provided by the push button control and large LCD display, it will fit seamlessly with almost any location.

PAW-FC-903AC

Features:

- For 2-pipe, AC fan
- Back lit LCD screen
- 3 speed control relay, for fan
- Economizer

PAW-FC-903EC

Features:

- For 2-pipe and 4-pipe, EC fan
- Back lit LCD screen
- Adjustable range EC fan control
- Economizer
- Connection to BMS via Modbus
- 1 DI for presence detection (key card switch)



Sanitary tanks

Combo tanks.

The best option to combine with Mono-bloc units. DHW tank with buffer tank. Designed for retrofit applications, the DHW tank with a buffer tank is particularly suitable for fast integration on an existing installation. Easy to install, nice looking, high efficiency for DHW production and for heating.

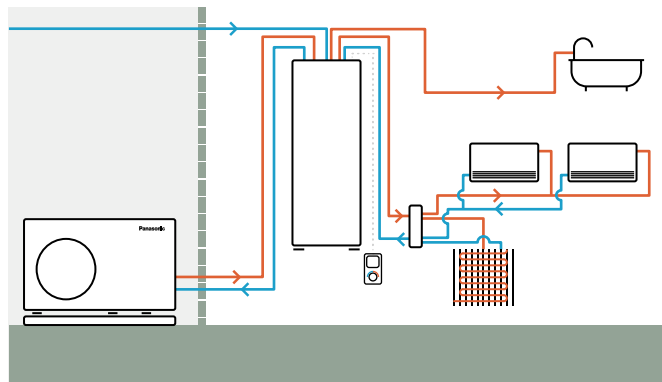

Reference	PAW-TD20B8E3-2		PAW-TD23B6E5	
Material	Enamelled		Stainless steel	
Dimension HxWxD	mm 1770x640x690		1750x600x646	
Weight (empty)	kg 150		111	
Water volume	L 185 + 80		230 + 60	
Power supply	V, Phase, Hz 230, 1, 50		230, 1, 50	
	Hot water tank	Buffer tank	Hot water tank	Buffer tank
Water volume	L 185	80	230	60
Max working pressure	MPa (bar) 0,8 (8)	0,6 (6)	1,0 (10)	0,3 (3,0)
Pressure test	MPa (bar) 1,2 (12)	0,9 (9)	1,5 (15)	0,39 (3,9)
Max working temp	°C 90	90	80	80
Connections	mm Ø22	Ø22	Ø22	Ø22, copper
Material	S 275 JR vitrified		EN 14521	EN 14521
Insulation	Material, t=mm	PUR, 50	PUR, 50	PUR, 50
Heating coil surface	m ²	2,1	—	—
Electrical heater	W	3000	—	—
Energy loss at 65 °C ¹⁾	kWh/24h	1,3	—	—
Energy efficiency class (from A+ to F) ²⁾	B	B	B	A
Standing loss	W	53	46	52
			29	

1) Tested pursuant to EN 12897:2006. 2) EU Regulation 812/2013. * Enamelled Combo tank is produced by Lapesa. Stainless steel Combo tank is produced by OSO.



Buffer tanks.

Reference	PAW-BTANK50L-2	PAW-BTANK100L	NEW PAW-BTANKG200L	NEW PAW-BTANKG260L
Water volume	L 48	100	194	252
Energy losses	W 35	55	60	83
Energy efficiency class (from A+ to F)	B	C	B	C
Material	Stainless Steel	Stainless Steel	Carbon Steel	Carbon Steel
Dimension (Height / Diameter)	mm 636 / 430	1175 / 430	983 / 620	1239 / 620
Net weight	kg 17	28	41	46

* Automatic air vent and drain cock are included. Built-in pocket sensor (sensor not included). ** 50 and 100 L Buffer Tanks are produced by OSO. 200 and 260 L Buffer Tanks are produced by Lapesa.



Enamelled tanks.

Type	Enamelled tank				Enamelled 2 coils tank (for bivalent solar + HP)	Square tank	
Reference	NEW PAW-TA15C1E5	PAW-TA20C1E5STD	PAW-TA30C1E5STD	PAW-TA40C1E5STD	PAW-TA30C2E5STD	PAW-TA20C1E5C	
Water volume	L	167	200	290	380	200	
Maximum water temperature	°C	90	95	95	95	95	
Dimension (Height / Diameter)	mm	1297/560	1340/610	1800/610	1835/670	1550x600x600	
Weight / filled with water	kg	88/255	90/280	120/389	191/572	134/327	
Electric heater	kW	—	3,00	3,00	3,00	—	
Power supply	V	—	230	230	230	—	
Material inside tank		Enamelled	Enamelled	Enamelled	Enamelled	Enamelled	
Exchange surface	m ²	1,8	1,8	2,6	3,8	3,5 / 1,2	
Energy loss at 65 °C ¹⁾	kWh/24h	1,08	1,37	1,61	1,76	1,37	
3 way valve accessory PAW-3WYVLV-HW, CZ-NV1 or CZ-NV2		Optional	Optional	Optional	Optional	Optional	Built-in 3 way valve
20 m temperature sensor cable included		Yes	Yes	Yes	Yes	Yes	Yes
Energy losses	W	45	57	67	73	73	57
Energy efficiency class (from A+ to F)		B	B	B	B	B	B
Warranty of the inner vessel		2 Years	2 Years	2 Years	2 Years	2 Years	2 Years
Maintenance required		Anode ²⁾	Anode ²⁾	Anode ²⁾	Anode ²⁾	Anode ²⁾	Anode ²⁾

1) Insulated tested under EN12897. 2) Refer to the service manual for further details. * PAW-TA15C1E5 is produced by Lapesa. All other Enamelled tanks and Square tank are produced by AEmail.



Stainless steel tanks.

Reference		PAW-TD20C1E5-1	PAW-TD30C1E5-1	PAW-TD30C1E5HI-1
Water volume	L	192	284	280
Maximum water temperature	°C	75	75	75
Dimension (Height / Diameter)	mm	1270/595	1750/595	1750/595
Weight / filled with water	kg	50/—	61/—	65/—
Electric heater	kW	1,5	1,5	1,5
Power supply	V	230	230	230
Material inside tank		Stainless steel	Stainless steel	Stainless steel
Exchange surface	m ²	1,8	1,8	2,35
Energy loss at 65 °C ¹⁾	kWh/24h	1,01	1,18	1,18
3 way valve accessory PAW-3WYVLV-HW, CZ-NV1 or CZ-NV2		Optional	Optional	Optional
20 m temperature sensor cable included		Yes	Yes	Yes
Energy losses	W	42	49	49
Energy efficiency class (from A+ to F)		A	A	A
Warranty		2 Years	2 Years	2 Years
Maintenance required		No	No	No

1) Insulated tested under EN12897. * Stainless steel tanks are produced by OSO.

Accessories for sanitary tanks

PAW-3WYVLV-HW	3 way valve for DHW tanks
CZ-NV1	3 way valve kit for inside of hydrokit for H and J Generations

Accessories for sanitary tanks

CZ-NV2	3 way valve kit for inside of hydrokit for K and L Generations
PAW-EANODE2	Impressed current anode for 200 L Stainless Steel tanks
PAW-EANODE3	Impressed current anode for 300 L Stainless Steel tanks

Heat recovery ventilation unit

The heat recovery ventilation unit is design not only to provide a good indoor air quality, but it is also designed to recover heat that would otherwise be lost throughout ventilation. These heat recovery ventilation systems are used to assist in the retention of heat.

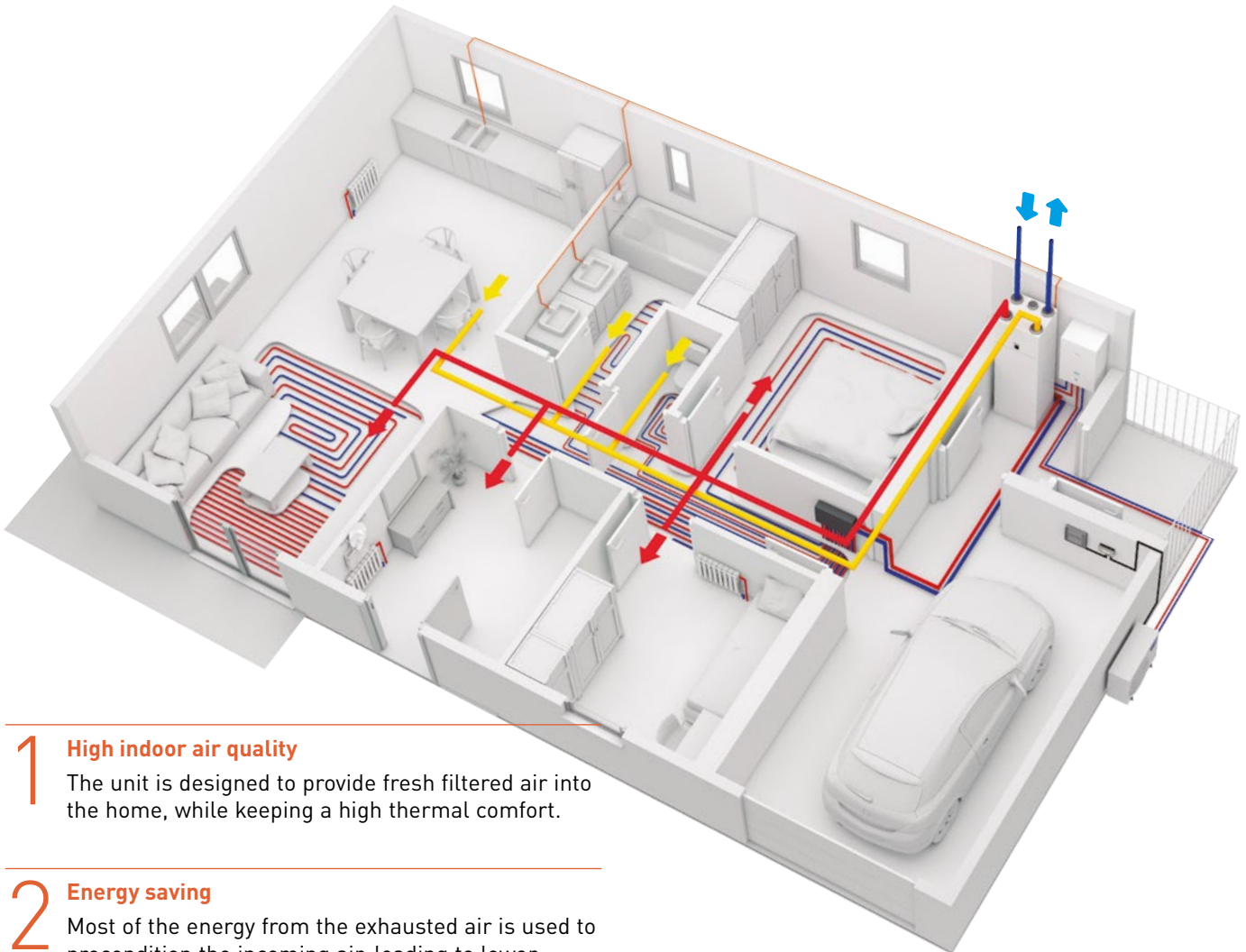

1 High indoor air quality
The unit is designed to provide fresh filtered air into the home, while keeping a high thermal comfort.

2 Energy saving
Most of the energy from the exhausted air is used to precondition the incoming air, leading to lower heating requirements in the building.

3 Space saving
The compact ventilation unit can be installed over the DHW square tank or the Aquarea All in One Compact indoor unit for an space-saving solution.

4 Better user interface
The Residential ventilation unit and the Aquarea Heat Pump can be controlled with one single user-friendly controller.

AQUAREA

Combine the Residential ventilation unit with Panasonic Aquarea for an space saving and highly efficient solution for heating, cooling, ventilation and DHW.



Heat Recovery Ventilation + Aquarea All in One Compact



Heat Recovery Ventilation + DHW Square Tank + Aquarea Mono-bloc



Heat Recovery Ventilation + DHW Square Tank + Aquarea Bi-bloc

* The unit can be mounted on a PAW-TA20C1E5C, on a WH-ADC0309J3E5C or installed on the wall (PAW-VEN-WBRK is needed).



Heat recovery ventilation unit		PAW-A2W-VENTA-R	PAW-A2W-VENTA-L
Nominal air flow rate	m ³ /h	204 @ 50 Pa	
Maximum air flow rate	m ³ /h	292 @ 100 Pa	
SPF		1,24 @ 204 m ³ /h	
Heat exchanger rotor drive type		Variable speed	
Exchanger type		Rotating	
Heat recovery efficiency		84%	
Power supply	V / Hz	230 / 50 / Single phase	
Power consumption	W	176	
Energy class, basic unit		A	
Energy class, unit with local control on demand		A	
Noise level	dB(A)	40	
Dimension (H x W x D)	mm	450 x 598 x 500	
Weight	kg	46	
Mounting position		Vertical	
Supply side		Right	Left
Duct connections	mm	DN125	
Filter class, supply air		F7/ePM1 60%	
Filter class, extract air		M5/ePM10 50%	
Minimum outdoor temperature	°C	-20	

* Heat recovery efficiency according to EN 13141-7. ** Heat recovery ventilation unit is produced by Systemair.

Accessories	
PAW-VEN-FLTKit	Supply and extract filters kit
PAW-VEN-ACCPCB	Optional PCB for additional functions
PAW-VEN-DPL	HRV touch control panel. White frame (cable must be ordered separately)
PAW-VEN-CBLEXT12	Cable with plug for electrical connection between unit and control panel, type CE and CD (12 m)
PAW-VEN-DIVPLG	Twin plugs for installation of several control panels type CD or CE for one unit

Accessories	
PAW-VEN-DPLBOX	HRV touch control panel wall-mounted kit
PAW-VEN-S-CO2RH-W	CO ₂ RH wall-mounted sensor
PAW-VEN-S-CO2-W	CO ₂ wall-mounted sensor
PAW-VEN-S-CO2-D	CO ₂ duct sensor
PAW-VEN-WBRK	Wall bracket kit for stand-alone installation on the wall
PAW-VEN-HTR06	Electrical duct heater 0,6 kW (includes relay)
PAW-VEN-HTR12	Electrical duct heater 1,2 kW (includes relay)

Main features of the residential ventilation unit

- Designed for areas up to approximately 140 m²
- High energy-efficiency rotary heat exchanger with EC - technology fans
- Moisture transfer function to minimize condensation in supply air during wintertime
- The built in humidity sensor in extract air can be used for demand control
- Control via touch display and Startup Wizard for easy commissioning
- Modbus communication via RS-485
- Option to control an Aquarea H Generation onwards heat pump from PAW-A2W-VENTA control panel (PAW-AW-MBS-H and PAW-VEN-ACCPCB required)

Control user-friendly interface

All settings and features accessible via a control panel, integrated into the front cover. The option for connecting one or more external control panels is available.

- Color touch screen with a user-friendly interface
- MANUAL and AUTO mode or choose preferred settings from the pre-configured user modes

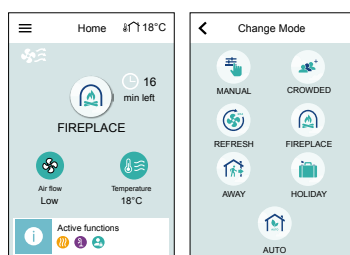

- If Aquarea H and J Generations heat pumps are connected with PAW-A2W-VENTA, the heat pump control options appear on the home screen in a separate tab

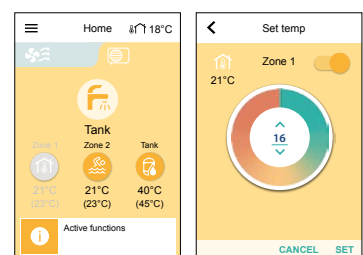

New counter flow ventilation

Controlled mechanical ventilation ensures the supply of fresh air inside a building in order to guarantee a good indoor air quality.



Universal mounting compact unit (Z).

- Suitable for small and medium size apartments, with nominal air flow up to 200 m³/h
- Universal mounting (horizontal or vertical)



Horizontal mounting unit (H).

- Suitable for single family houses, with nominal air flow rates up to 350 m³/h
- Horizontal mounting
- Easily accessible lower panel for maintenance and inspection



Vertical mounting unit (V).

- Suitable for single family houses, with nominal air flow rates up to 350 m³/h
- Vertical mounting
- Easily accessible front panel for maintenance and inspection





Counter flow ventilation	PAW-	VENTX10Z	VENTX15Z	VENTX20H	VENTX20V	VENTX30H	VENTX30V	VENTX40H	VENTX40V	
Air flow	Nominal / Max	m³/h	91/130	147/210	109/155	112/170	210/300	210/300	238/340	266/380
Static pressure	Nominal / Max	Pa	50/100	50/100	50/100	50/100	50/100	50/100	50/100	50/100
Type of HEX		Counter flow HRV	Counter flow HRV	Counter flow HRV	Counter flow HRV	Counter flow HRV	Counter flow HRV	Counter flow HRV	Counter flow HRV	
Recovery efficiency	%	87	85	86	86	85	86	89	87	
Energy class		A	A	A	A	A	A	A	A	
Power supply	Voltage	V	230	230	230	230	230	230	230	
	Phase		Single phase	Single phase	Single phase	Single phase	Single phase	Single phase	Single phase	
	Frequency	Hz	50	50	50	50	50	50	50	
Power consumption	Nominal	W	80	140	110	110	180	180	350	350
Sound Power LWA		dB(A)	48	51	49	48	50	50	52	51
Dimensions	HxWxD	mm	255x580x580	255x580x580	260x480x800	510x430x625	295x600x795	590x575x785	290x650x1150	590x735x785
Weight		kg	19	19	25	32	30	38	38	42
Mounting position			Horizontal / Vertical	Horizontal / Vertical	Horizontal	Vertical	Horizontal	Vertical	Horizontal	Vertical
Filter class			ePM1 80%	ePM1 80%	ePM1 80%	ePM1 80%	ePM1 70%	ePM1 70%	ePM1 70%	ePM1 70%
Duct connection		mm	160	160	160	160	160	160	160	160

* Produced by Sinergia.

Accessories	
PAW-VEN-CTRLB	Digital remote control (black). Integrated air quality, temperature and humidity sensors
PAW-VEN-CTRLW	Digital remote control (white). Integrated air quality, temperature and humidity sensors
PAW-VEN-HTR05	Electrical duct heater 0,5 kW, DN160 mm
PAW-VEN-HTR10	Electrical duct heater 1,0 kW, DN160 mm
PAW-VEN-FLT1	Spare F7 filter kit (2 pcs) for models 10Z, 15Z, 20H and 20V
PAW-VEN-FLT2	Spare F7 filter kit (2 pcs) for models 30H and 30V

Accessories	
PAW-VEN-FLT3	Spare F7 filter kit (2 pcs) for models 40H
PAW-VEN-FLT4	Spare F7 filter kit (2 pcs) for models 40V
PAW-VEN-ACFLT1	Activated carbon filter (1 pc) for models 10Z, 15Z, 20H and 20V
PAW-VEN-ACFLT2	Activated carbon filter (1 pc) for models 30H and 30V
PAW-VEN-ACFLT3	Activated carbon filter (1 pc) for models 40H
PAW-VEN-ACFLT4	Activated carbon filter (1 pc) for models 40V

Counter flow ventilation units are equipped with two fans to supply and extract air. A cross-flow heat exchanger recovers the energy contained in the extracted air and transfers it to the supplied air. This significantly reduces the building's energy consumption, while at the same time keeping a good quality of the indoor air.

Balanced ventilation

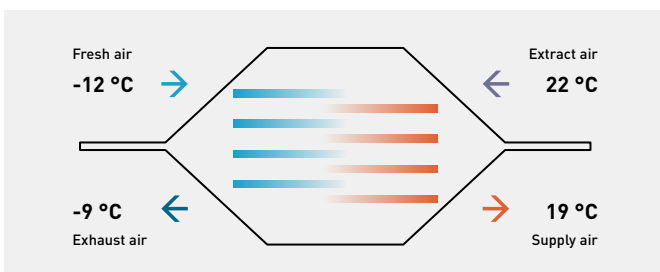

- Suitable for single family houses or apartments with low energy requirements
- High-efficiency sensible heat recovery, thanks to polypropylene counter-flow heat exchanger with large exchange surface and low pressure drop
- High comfort and quiet operation, by using brushless fans with electronic motor and modulating control
- Highly efficient air renewal and filtration, with 80% ePM1 filters
- 3 unit types: compact universal mounting (Z), horizontal mounting (H) and vertical mounting (V)
- Compact dimensions for simplified installation and panel easily accessible for maintenance and inspection

DHW Stand Alone

The wide range of DHW Stand Alone heat pump is a great solution to adapt to any type of family house.



DHW Stand Alone: highly efficient heat pump water heater.

The wall type is available in 100 and 150 L capacities, and the floor-standing in 200 and 270 L. For reaching even more efficient use the 270 L is available in additional coil, it is able to connect solar water production.

- A+ Highly efficient domestic hot water heat pump
- Provides reduced power consumption up to 72% compared with traditional electric water heater
- Easy to install
- Being CFC-free, this water heater is environmentally friendly

1 Energy saving

- Digital control panel with energy consumption monitoring
- Photovoltaic function
- Compatible with ducted fresh air intake installations
- Boiler / Solar Coil (only PAW-DHW270C1F)

2 Comfort

- Different modes of operation based on user needs
- Mode AUTO: Intelligent Temperature Set Point, thanks to monitoring hot water usage
- Mode BOOST, Mode ECO and Mode ABSENCE

3 Durability

- Diamond-quality enamel lining the inner tank
- Pressure relief valve which provides safety if any malfunctions or pressure rise
- Dielectric union preventing corrosion
- Specific lip gasket preventing rust around the flange



Type	Wall-mounted			Floor-standing		
	Reference	PAW-DHW100W-1	PAW-DHW150W-1	PAW-DHW200F	PAW-DHW270F	PAW-DHW270C1F
Water volume	L	100	150	200	270	263
Dimension (HxWxD)	mm	1209 x 522 x 538	1527 x 522 x 538	1617 x 620 x 665	1957 x 620 x 665	1957 x 620 x 665
Empty weight	kg	57	66	80	92	111
Hot and cold connection		¾" M	¾" M	¾" M	¾" M	¾" M
Anticorrosion system	Anode	Magnesium	Magnesium	Magnesium	Magnesium	Magnesium
Rated water pressure	Mpa (bar)	0,8 (8)	0,8 (8)	0,8 (8)	0,8 (8)	0,8 (8)
Electrical connection	V / Hz	230/50	230/50	230/50	230/50	230/50
Total maximum power	W	1550	1950	2300	2300	2300
Maximal power heat pump	W	350	350	700	700	700
Power electric heating element	W	1200	1600	1600	1600	1600
Heat pump water temperature range	°C	50 - 62	50 - 62	50 - 62	50 - 62	50 - 62
Heat pump air temperature range	°C	-5 - +43	-5 - +43	-5 - +43	-5 - +43	-5 - +43
Duct diameter	mm	125	125	160	160	160
Air flow (without duct)	m³/h	160	160	310/390	310/390	310/390
Load losses acceptable on ventilation circuit, without affecting performance	Pa	70	70	25	25	25
Sound power ¹⁾	dB(A)	45	45	53	53	53
Refrigerant R134a (wall-mounted) / R513A (floor-standing)	kg	0,52	0,58	0,80	0,86	0,86
Refrigerant volume in tons of CO ₂ equivalent	TCO ₂ Eq.	0,74	0,83	0,50	0,54	0,54
Refrigerant weight per liter	kg/L	0,0052	0,0039	0,0040	0,0032	0,0032
Hot water quantity at 40 °C: V40td	L	151,0	182,0	265,5	361,2	357,9
Acoustic power ErP ²⁾	dB(A)	45	45	53	53	53
Energy efficiency class (from A+ to F)		A+	A+	A+	A+	A+
Connectable to PV		Yes	Yes	Yes	Yes	Yes
Additional coil exchanger connection		—	—	—	—	1" M
Additional coil surface	m²	—	—	—	—	1,2
Warranty of the inner vessel		5 Years	5 Years	5 Years	5 Years	5 Years
Performance at 7 °C air temperature		[EN 16147] ducted at 25 Pa		[CDC LCIE 103-15/C] ducted at 30 Pa ³⁾		
Coefficient of performance [COP] according load profile		2,66 - M	3,05 - L	2,81 - L	3,16 - XL	3,05 - XL
Standby input power [P _{std}]	W	18	24	32	29	33
Heating up time (t _h)	h. Min	6h47	10h25	07h11	10h39	11h04
Reference hot water temperature [T _{ref}]	°C	52,7	53,2	52,7	53,1	52,9
Flow rate (air)	m³/h	140	110	320	320	320
Performance at 15 °C air temperature [EN 16147]						
Coefficient of performance [COP] according load profile		2,88 - M	3,28 - L	3,05 - L	3,61 - XL	3,44 - XL
Standby input power [P _{std}]	W	19	25	30	30	33
Heating up time (t _h)	h. Min	6h07	9h29	6h24	8h34	8h40
Reference hot water temperature [T _{ref}]	°C	52,6	53,4	52,8	53,0	53,1
Flow rate (air)	m³/h	140	110	320	320	320

1) According to ISO3744. 2) Compliant with EN 16147 conditions. 3) Performance measured for a water heater from 10 °C to T_{ref} according to the protocol of the NF Electricity Performance Mark specifications No.LCIE 103-15C, selfheating thermodynamic water heaters (based on standard EN 16147). * DHW Stand Alone is produced by C.I.C.E.

Accessories

PAW-DHW-STAND Rack for suspended device for 100 and 150 liters models

Ideal for small surfaces

Suitable for all installations (adapted to small surfaces, low ceiling, corner).

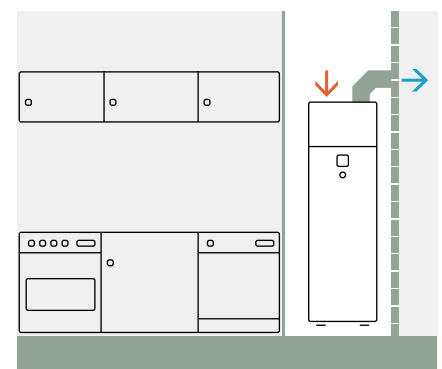
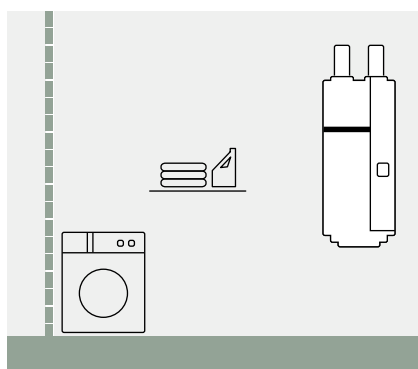

Accessories and control

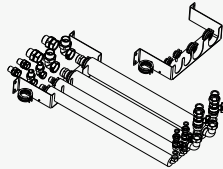
Dual controller system	All in One accessories
 <p>Additional remote controller for K and L Generations</p> <p>-----</p> <p>CZ-RTW1</p>	 <p>Flexible pipings and wall mounting plate for All in One J Generation (not compatible with WH-ADC0309J3E5C).</p> <p>-----</p> <p>PAW-ADC-PREKIT-1</p>

Special outdoor supports

 <p>Tray for condenser water compatible with outdoor elevation platform.</p> <p>-----</p> <p>PAW-WTRAY</p>	 <p>Outdoor elevation platform. Dimension (HxWxD): 400x900x400 mm</p> <p>-----</p> <p>PAW-GRDSTD40</p>	 <p>Outdoor base ground support for noise and vibration absorption. Dimension (HxWxD): 600x95x130 mm Safe working load: 500 kg</p> <p>-----</p> <p>PAW-GRDBSE20</p>
--	--	---

PCB's for additional functions

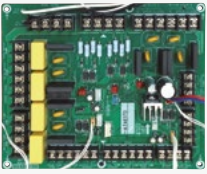



 <p>PCB for advanced functions in H and J Generations.</p> <p>-----</p> <p>CZ-NS4P</p> <p>NEW PCB for advanced functions in K and L Generations.</p> <p>-----</p> <p>CZ-NS5P</p>

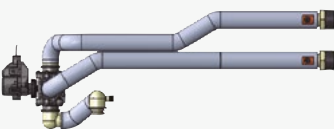

Deice accessories

 <p>Base pan heater for all old Bi-bloc and Mono-bloc (not for the 3 and 5 kW).</p> <p>-----</p> <p>CZ-NE1P</p> <p>Base pan heater for Bi-bloc 3 and 5 kW (except L Generation) and 7 and 9 kW K Generation.</p> <p>-----</p> <p>CZ-NE2P</p>	<p>Base pan heater for H and J Generations.</p> <p>-----</p> <p>CZ-NE3P</p> <p>NEW Base pan heater for 5, 7 and 9 kW L Generation.</p> <p>-----</p> <p>CZ-NE4P</p>
--	--

Hydraulic accessories

 <p>3 way valve kit for inside of hydrokit for H and J Generations.</p> <p>-----</p> <p>CZ-NV1</p> <p>NEW 3 way valve kit for inside of hydrokit for K and L Generations.</p> <p>-----</p> <p>CZ-NV2</p>	 <p>3 way valve for DHW tanks.</p> <p>-----</p> <p>PAW-3WVVLV-HW</p>	 <p>1 anti-freeze valve. It is required to order 2 valves per system.</p> <p>-----</p> <p>PAW-A2W-AFVLV</p>	 <p>Optional magnet for the water filter in H Generation models.</p> <p>-----</p> <p>PAW-A2W-MGTFILTER</p>
--	--	--	--

Accessories interfaces



Aquarea Smart Cloud for remote control and maintenance through wireless or wired LAN.

CZ-TAW1B

10 m extension cable for CZ-TAW1B.

CZ-TAW1-CBL



NEW External meter gateway.

PAW-A2W-EXTMETER



KNX interface for H Generation onwards (Intesis).

PAW-AW-KNX-H



Modbus interface for H Generation onwards (Intesis).

PAW-AW-MBS-H



NEW KNX interface for H Generation onwards (Airzone).

PAW-AZAW-KNX-1



NEW Modbus interface for H Generation onwards (Airzone).

PAW-AZAW-MBS-1

Cascade manager



Room thermostats



Cascade manager for Aquarea Heat Pumps.

PAW-A2W-CMH-2



Wired LCD room thermostat with weekly timer.

PAW-A2W-RTWIRED



Wireless LCD room thermostat with weekly timer.

PAW-A2W-RTWIRELESS

Sensors for Aquarea H Generation onwards



Outdoor ambient sensor.

PAW-A2W-TS0D



Zone room sensor.

PAW-A2W-TSRT



Zone water sensor.

PAW-A2W-TSHC



Solar sensor.

PAW-A2W-TSSO



Buffer tank sensor.



Zone water sensor PAW-A2W-TSHC is also required to operate buffer tank sensor.

PAW-A2W-TSBU

Smart fan coil accessories



<p>Kits of 2 legs to protect the water pipings.</p> <p>----- PAW-AAIR-LEGS-1</p>	<p>Motor connection cable for units with hydraulic connections on the right.</p> <p>----- PAW-AAIR-RHCABLE</p>
---	---

Fan coil accessories





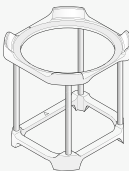





 <p>Advanced wired remote controller for fan coil.</p> <p>----- PAW-FC-RC1</p>	 <p>Wired remote controller with touch control for 2-pipe and 4-pipe, EC fan coil (control + Modbus).</p> <p>----- PAW-FC-907EC</p> <p>Wired remote controller with touch control for 2-pipe, AC fan coil (control only).</p> <p>----- PAW-FC-907AC</p>	 <p>Wired remote controller for 2-pipe and 4-pipe, EC fan coil (control + Modbus).</p> <p>----- PAW-FC-903EC</p> <p>Wired remote controller for 2-pipe, AC fan coil (control only).</p> <p>----- PAW-FC-903AC</p>	
<p>2 way valve + drain pan for ducted models 010-060.</p> <p>----- PAW-FC-2WY-11/55-1</p>	<p>2 way valve + drain pan for ducted models 070-080.</p> <p>----- PAW-FC-2WY-65/90-1</p>	<p>2 way valve + drain pan for ducted model F040.</p> <p>----- PAW-FC-2WY-F040</p>	<p>2 way valve for wall-mounted.</p> <p>----- PAW-FC2-2WY-K007</p>
<p>3 way valve + drain pan for ducted models 010-060.</p> <p>----- PAW-FC-3WY-11/55-1</p>	<p>3 way valve + drain pan for ducted models 070-080.</p> <p>----- PAW-FC-3WY-65/90-1</p>	<p>3 way valve + drain pan for ducted model F040.</p> <p>----- PAW-FC-3WY-F040</p>	<p>3 way valve for wall-mounted.</p> <p>----- PAW-FC2-3WY-K007</p>

Sanitary tank accessories





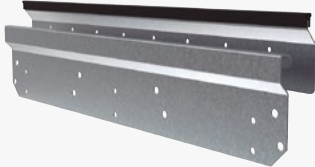

DHW Stand Alone accessories

 <p>Tank sensor with 6 m cable length.</p> <p>----- PAW-TS1</p>	<p>Tank sensor with 20 m cable length.</p> <p>----- PAW-TS2</p>	<p>Tank sensor with 6 m cable length and only 6 mm diameter.</p> <p>----- PAW-TS4</p>	 <p>Rack for suspended device for 100 and 150 liters models.</p> <p>----- PAW-DHW-STAND</p>
 <p>Temperature sensor kit for third party tank (with copper pocket and 6 m length sensor cable).</p> <p>----- CZ-TK1</p>	<p>NEW impressed current anode for 200 L Stainless Steel tanks.</p> <p>----- PAW-EANODE2</p>	 <p>NEW impressed current anode for 300 L Stainless Steel tanks.</p> <p>----- PAW-EANODE3</p>	

Heat recovery ventilation accessories

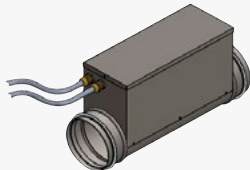
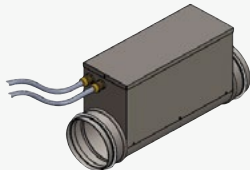
 <p>Supply and extract filters kit.</p> <p>-----</p> <p>PAW-VEN-FLTKIT</p>	 <p>Optional PCB for additional functions.</p> <p>-----</p> <p>PAW-VEN-ACPCB</p>	 <p>HRV touch control panel. White frame (cable must be ordered separately).</p> <p>-----</p> <p>PAW-VEN-DPL</p>	 <p>Cable with plug for electrical connection between unit and control panel, type CE and CD (12 m).</p> <p>-----</p> <p>PAW-VEN-CBLEXT12</p>
 <p>Twin plugs for installation of several control panels type CD or CE for one unit.</p> <p>-----</p> <p>PAW-VEN-DIVPLG</p>	 <p>HRV touch control panel wall-mounted kit.</p> <p>-----</p> <p>PAW-VEN-DPLBOX</p>	 <p>CO₂ RH wall-mounted sensor.</p> <p>-----</p> <p>PAW-VEN-S-C02RH-W</p>	 <p>CO₂ wall-mounted sensor.</p> <p>-----</p> <p>PAW-VEN-S-C02-W</p>
 <p>CO₂ duct sensor.</p> <p>-----</p> <p>PAW-VEN-S-C02-D</p>	 <p>Wall bracket kit for stand-alone installation on the wall.</p> <p>-----</p> <p>PAW-VEN-WBRK</p>	 <p>Electrical duct heater 0,6 kW (includes relay).</p> <p>-----</p> <p>PAW-VEN-HTR06</p>	 <p>Electrical duct heater 1,2 kW (includes relay).</p> <p>-----</p> <p>PAW-VEN-HTR12</p>

NEW counter flow ventilation accessories

 <p>Digital remote control (black). Integrated air quality, temperature and humidity sensors.</p> <p>-----</p> <p>PAW-VEN-CTRLB</p>	 <p>Digital remote control (white). Integrated air quality, temperature and humidity sensors.</p> <p>-----</p> <p>PAW-VEN-CTRLW</p>	 <p>Electrical duct heater 0,5 kW, DN160 mm.</p> <p>-----</p> <p>PAW-VEN-HTR05</p>	 <p>Electrical duct heater 1,0 kW, DN160 mm.</p> <p>-----</p> <p>PAW-VEN-HTR10</p>
 <p>Spare F7 filter kit (2 pcs) for models 10Z, 15Z, 20H and 20V.</p> <p>-----</p> <p>PAW-VEN-FLT1</p> <p>Spare F7 filter kit (2 pcs) for models 40H.</p> <p>-----</p> <p>PAW-VEN-FLT3</p>	 <p>Spare F7 filter kit (2 pcs) for models 30H and 30V.</p> <p>-----</p> <p>PAW-VEN-FLT2</p> <p>Spare F7 filter kit (2 pcs) for models 40V.</p> <p>-----</p> <p>PAW-VEN-FLT4</p>	 <p>Activated carbon filter (1 pc) for models 10Z, 15Z, 20H and 20V.</p> <p>-----</p> <p>PAW-VEN-ACFLT1</p> <p>Activated carbon filter (1 pc) for models 40H.</p> <p>-----</p> <p>PAW-VEN-ACFLT3</p>	 <p>Activated carbon filter (1 pc) for models 30H and 30V.</p> <p>-----</p> <p>PAW-VEN-ACFLT2</p> <p>Activated carbon filter (1 pc) for models 40V.</p> <p>-----</p> <p>PAW-VEN-ACFLT4</p>

Heating and cooling capacity tables

Based on outlet temperature and outside temperature.

Aquarea High Performance Hydraulic Split All in One L Generation Single phase. Heating and Cooling - R290

WH-WDG05LE5

Tamb	HC	IP	COP	HC	IP	COP	HC	IP	COP	HC	IP	COP
LWC	35	35	35	45	45	45	55	55	55	65	65	65
-15	5,00	1,94	2,58	5,00	2,31	2,16	5,00	2,63	1,90	4,60	2,88	1,60
-7	5,00	1,66	3,01	5,00	1,94	2,58	5,00	2,36	2,12	5,00	2,62	1,91
2	5,00	1,42	3,52	5,00	1,71	2,92	5,00	2,14	2,34	5,00	2,54	1,97
7	5,00	0,99	5,05	5,00	1,27	3,94	5,00	1,63	3,07	5,00	2,03	2,46

WH-WDG07LE5

Tamb	HC	IP	COP	HC	IP	COP	HC	IP	COP	HC	IP	COP
LWC	35	35	35	45	45	45	55	55	55	65	65	65
-15	6,00	2,50	2,40	5,50	2,60	2,12	5,20	2,89	1,80	4,80	3,00	1,60
-7	5,80	1,93	3,01	5,80	2,32	2,50	5,80	2,74	2,12	5,70	3,16	1,80
2	6,85	2,00	3,43	6,60	2,34	2,82	6,25	2,67	2,34	5,60	2,80	2,00
7	7,00	1,42	4,93	7,00	1,90	3,68	7,00	2,35	2,98	6,60	2,85	2,32

WH-WDG09LE5

Tamb	HC	IP	COP	HC	IP	COP	HC	IP	COP	HC	IP	COP
LWC	35	35	35	45	45	45	55	55	55	65	65	65
-15	7,40	3,20	2,31	6,80	3,40	2,00	6,30	3,55	1,77	5,60	3,55	1,58
-7	7,00	2,50	2,80	7,00	2,98	2,35	7,00	3,29	2,13	6,50	3,53	1,84
2	7,00	2,05	3,41	7,00	2,50	2,80	7,00	2,90	2,41	6,70	3,35	2,00
7	9,00	1,98	4,55	9,00	2,58	3,49	8,90	2,94	3,03	8,90	3,56	2,50

Aquarea High Performance Hydraulic Split All in One L Generation Single phase. Heating and Cooling - R290

WH-WDG05LE5

Tamb	CC	IP	EER	CC	IP	EER
LWC	7	7	7	18	18	18
35	5,00	1,55	3,23	5,00	1,00	5,00

WH-WDG07LE5

Tamb	CC	IP	EER	CC	IP	EER
LWC	7	7	7	18	18	18
35	7,00	2,31	3,03	7,00	1,48	4,73

WH-WDG09LE5

Tamb	CC	IP	EER	CC	IP	EER
LWC	7	7	7	18	18	18
35	8,20	2,91	2,82	9,00	2,15	4,19

Tamb: Ambient Temperature (°C). LWC: Leaving Water Condenser Temperature (°C). HC: Heating Capacity (kW). CC: Cooling Capacity (kW). IP: Input Power (kW). This data is measured by Panasonic in accordance with EN14511-2 standard. This data is for reference purpose only, and does not guarantee the performance.

Aquarea EcoFleX. Single phase. Heating and Cooling - R32

CU-2WZ71YBE5

Tamb	HC	IP	COP	HC	IP	COP	HC	IP	COP	HC	IP	COP
LWC	25	25	25	35	35	35	45	45	45	55	55	55
-15	4,85	2,15	2,26	4,75	2,28	2,08	4,65	2,44	1,91	4,50	3,20	1,41
-7	5,40	1,70	3,18	5,60	1,97	2,84	5,60	2,40	2,33	5,30	2,78	1,91
2	6,50	1,77	3,67	6,70	2,06	3,25	6,60	2,45	2,69	6,00	2,89	2,08
7	8,16	1,63	5,01	8,00	1,90	4,21	8,00	2,30	3,48	8,00	2,85	2,81
12	8,22	1,28	6,42	8,00	1,52	5,26	8,00	2,00	4,00	8,00	2,60	3,08

Aquarea High Performance Bi-bloc K Generation Single phase. Heating and Cooling - R32

WH-UDZ03KE5

Tamb	HC	IP	COP	HC	IP	COP
LWC	35	35	35	55	55	55
-15	3,20	1,37	2,34	2,75	1,92	1,43
-7	3,30	1,18	2,80	3,20	1,79	1,79
2	3,20	0,88	3,64	3,20	1,46	2,19
7	3,20	0,60	5,33	3,20	1,14	2,81

WH-UDZ05KE5

Tamb	HC	IP	COP	HC	IP	COP
LWC	35	35	35	55	55	55
-15	5,00	2,11	2,37	4,30	2,61	1,65
-7	5,00	1,79	2,79	5,00	2,65	1,89
2	5,00	1,40	3,57	5,00	2,18	2,29
7	5,00	0,98	5,10	5,00	1,65	3,03

WH-UDZ07KE5

Tamb	HC	IP	COP	HC	IP	COP
LWC	35	35	35	55	55	55
-15	5,60	2,38	2,35	5,00	3,20	1,56
-7	5,75	1,95	2,95	5,35	2,70	1,98
2	6,85	2,00	3,43	6,25	2,80	2,23
7	7,00	1,44	4,86	7,00	2,40	2,92

WH-UDZ09KE5

Tamb	HC	IP	COP	HC	IP	COP
LWC	35	35	35	55	55	55
-15	7,40	3,20	2,31	5,40	3,42	1,58
-7	6,25	2,20	2,84	5,90	3,06	1,93
2	7,00	2,06	3,40	6,30	2,89	2,18
7	9,00	1,98	4,55	8,90	3,04	2,93

Aquarea High Performance Bi-bloc K Generation Single phase. Heating and Cooling - R32

WH-UDZ03KE5

Tamb	CC	IP	EER	CC	IP	EER
LWC	7	7	7	18	18	18
35						

WH-UDZ05KE5

Tamb	CC	IP	EER	CC	IP	EER
LWC	7	7	7	18	18	18
35	5,00	1,64	3,05	5,00	1,02	4,90

WH-UDZ07KE5

Tamb	CC	IP	EER	CC	IP	EER
LWC	7	7	7	18	18	18
35	6,70	2,21	3,03	6,70	1,42	4,72

WH-UDZ09KE5

Tamb	CC	IP	EER	CC	IP	EER
LWC	7	7	7	18	18	18
35	8,20	3,02	2,72	9,00	2,15	4,18

Tamb: Ambient Temperature [°C]. LWC: Leaving Water Condenser Temperature [°C]. HC: Heating Capacity (kW). CC: Cooling Capacity (kW). IP: Input Power (kW). This data is measured by Panasonic in accordance with EN14511-2 standard. This data is for reference purpose only, and does not guarantee the performance.

Heating and cooling capacity tables

Based on outlet temperature and outside temperature.

Aquarea High Performance Bi-bloc J Generation Single phase. Heating and Cooling · R32

WH-UD03JE5

Tamb	HC	IP	COP	HC	IP	COP	HC	IP	COP	HC	IP	COP	HC	IP	COP
LWC	25	25	25	35	35	35	45	45	45	55	55	55	60	60	60
-20	2,50	1,11	2,25	2,52	1,31	1,92	2,24	1,59	1,41	2,12	1,80	1,18	—	—	—
-15	3,00	1,14	2,63	3,20	1,37	2,34	3,00	1,62	1,85	2,75	1,92	1,43	—	—	—
-7	2,99	0,91	3,29	3,30	1,18	2,80	3,25	1,47	2,21	3,20	1,79	1,79	3,00	1,88	1,60
2	2,92	0,69	4,23	3,20	0,88	3,64	3,20	1,13	2,83	3,20	1,46	2,19	3,15	1,67	1,89
7	3,09	0,49	6,31	3,20	0,60	5,33	3,20	0,84	3,81	3,20	1,14	2,81	2,95	1,22	2,42
25	3,27	0,23	14,22	3,27	0,38	8,61	3,61	0,63	5,73	4,06	1,11	3,66	4,03	1,14	3,54

WH-UD05JE5

Tamb	HC	IP	COP	HC	IP	COP	HC	IP	COP	HC	IP	COP	HC	IP	COP
LWC	25	25	25	35	35	35	45	45	45	55	55	55	60	60	60
-20	3,60	1,57	2,29	3,51	1,81	1,94	3,16	1,99	1,59	2,46	2,11	1,17	—	—	—
-15	4,46	1,72	2,59	4,20	1,93	2,18	3,75	2,18	1,72	3,00	2,12	1,42	—	—	—
-7	4,18	1,33	3,14	4,20	1,62	2,59	3,80	1,82	2,09	3,55	2,08	1,71	3,25	2,15	1,51
2	4,07	1,01	4,03	4,20	1,32	3,18	4,20	1,64	2,56	4,10	2,06	1,99	4,10	2,21	1,86
7	5,20	0,83	6,27	5,00	1,00	5,00	5,00	1,41	3,55	5,00	1,84	2,72	4,25	2,10	2,02
25	5,00	0,52	9,62	5,00	0,72	6,94	5,30	0,98	5,41	5,60	1,27	4,41	4,80	1,27	3,78

WH-UD07JE5

Tamb	HC	IP	COP	HC	IP	COP	HC	IP	COP	HC	IP	COP	HC	IP	COP
LWC	25	25	25	35	35	35	45	45	45	55	55	55	60	60	60
-20	4,33	1,64	2,64	3,98	1,88	2,12	3,83	2,26	1,69	3,30	2,77	1,19	—	—	—
-15	5,16	1,69	3,05	4,75	2,00	2,38	4,65	2,40	1,94	4,50	2,96	1,52	—	—	—
-7	5,64	1,56	3,62	5,60	1,95	2,87	5,50	2,30	2,39	5,25	2,70	1,94	4,98	2,90	1,72
2	6,80	1,57	4,33	6,85	2,01	3,41	6,75	2,40	2,81	6,20	2,80	2,21	6,18	2,91	2,12
7	7,55	1,15	6,57	7,00	1,47	4,76	7,00	1,96	3,57	7,00	2,48	2,82	6,86	2,75	2,49
25	7,00	0,62	11,29	6,88	0,90	7,64	7,00	1,33	5,26	6,92	1,75	3,95	6,83	1,90	3,59

WH-UD09JE5-1

Tamb	HC	IP	COP	HC	IP	COP	HC	IP	COP	HC	IP	COP	HC	IP	COP
LWC	25	25	25	35	35	35	45	45	45	55	55	55	60	60	60
-20	4,95	1,93	2,56	6,20	3,00	2,07	5,28	3,09	1,71	4,23	3,33	1,27	—	—	—
-15	7,58	2,70	2,81	7,40	3,20	2,31	6,29	3,26	1,93	5,20	3,42	1,52	—	—	—
-7	6,39	1,81	3,53	6,12	2,20	2,78	5,88	2,61	2,25	5,90	3,06	1,93	5,65	3,24	1,74
2	6,96	1,61	4,32	7,00	2,06	3,40	6,85	2,50	2,74	6,30	2,92	2,16	7,26	3,33	2,18
7	9,44	1,55	6,09	9,00	2,01	4,48	9,00	2,61	3,45	8,95	3,22	2,78	8,62	3,47	2,48
25	8,27	0,95	8,71	8,12	1,29	6,29	8,71	1,80	4,84	7,83	1,97	3,97	6,08	1,72	3,53

Aquarea High Performance Bi-bloc J Generation Single phase. Heating and Cooling · R32

Outdoor		WH-UD03JE5									WH-UD05JE5								
Tamb	CC	IP	EER	CC	IP	EER	CC	IP	EER	CC	IP	EER	CC	IP	EER	CC	IP	EER	
LWC	7	7	7	14	14	14	18	18	18	7	7	7	14	14	14	18	18	18	
16	3,56	0,57	6,25	4,32	0,55	7,85	3,47	0,41	8,46	3,59	0,56	6,41	4,23	0,54	7,83	4,79	0,52	9,21	
25	3,29	0,73	4,51	4,06	0,72	5,64	3,27	0,52	6,29	4,61	1,18	3,91	5,54	1,21	4,58	5,23	0,90	5,81	
35	3,20	0,91	3,52	3,56	0,93	3,83	3,20	0,68	4,71	4,50	1,50	3,00	5,08	1,51	3,36	4,80	1,12	4,29	
43	2,68	1,06	2,53	3,34	1,09	3,06	2,79	0,82	3,40	3,77	1,71	2,20	4,94	1,80	2,74	4,30	1,35	3,19	
Outdoor		WH-UD07JE5									WH-UD09JE5-1								
Tamb	CC	IP	EER	CC	IP	EER	CC	IP	EER	CC	IP	EER	CC	IP	EER	CC	IP	EER	
LWC	7	7	7	14	14	14	18	18	18	7	7	7	14	14	14	18	18	18	
16	5,20	0,81	6,42	6,62	0,73	9,07	7,04	0,72	9,78	6,85	1,18	5,81	8,80	1,15	7,65	9,11	1,15	7,92	
25	7,40	1,73	4,28	9,30	1,78	5,22	7,65	1,10	6,95	9,00	2,35	3,83	10,40	2,48	4,19	9,10	1,58	5,76	
35	6,70	2,21	3,03	8,10	2,23	3,63	6,70	1,42	4,72	8,20	3,02	2,72	9,90	3,02	3,28	9,00	2,15	4,19	
43	4,50	1,99	2,26	5,44	2,00	2,72	5,10	1,71	2,98	3,80	1,99	1,91	4,70	1,97	2,39	5,35	1,99	2,69	

Tamb: Ambient Temperature (°C). LWC: Leaving Water Condenser Temperature (°C). HC: Heating Capacity (kW). CC: Cooling Capacity (kW). IP: Input Power (kW). This data is measured by Panasonic in accordance with EN14511-2 standard. This data is for reference purpose only, and does not guarantee the performance.

Aquarea High Performance Bi-bloc H Generation Single phase. Heating and Cooling · R410A

WH-UD12HE5

Tamb	HC	IP	COP	HC	IP	COP	HC	IP	COP	HC	IP	COP	HC	IP	COP	HC	IP	COP
LWC	30	30	30	35	35	35	40	40	40	45	45	45	50	50	50	55	55	55
-15	9,30	3,46	2,69	8,90	3,62	2,46	8,50	3,79	2,24	8,10	3,95	2,05	7,50	4,05	1,85	7,00	4,16	1,68
-7	10,40	3,37	3,09	10,00	3,66	2,73	9,60	3,95	2,43	9,20	4,24	2,17	8,70	4,26	2,04	8,20	4,27	1,92
2	11,80	3,10	3,81	11,40	3,31	3,44	11,00	3,53	3,12	10,60	3,74	2,83	9,80	3,94	2,49	9,10	4,14	2,20
7	12,00	2,10	5,71	12,00	2,53	4,74	12,00	2,96	4,05	12,00	3,39	3,54	12,00	3,78	3,17	12,00	4,16	2,88
25	12,00	1,38	8,70	12,00	1,66	7,23	11,80	1,94	6,08	11,70	2,23	5,25	11,50	2,49	4,62	11,40	2,74	4,16

WH-UD16HE5

Tamb	HC	IP	COP	HC	IP	COP	HC	IP	COP	HC	IP	COP	HC	IP	COP	HC	IP	COP
LWC	30	30	30	35	35	35	40	40	40	45	45	45	50	50	50	55	55	55
-15	10,60	4,09	2,59	10,30	4,38	2,35	10,00	4,67	2,14	9,70	4,96	1,96	8,80	4,94	1,78	7,90	4,91	1,61
-7	11,90	4,03	2,95	11,40	4,43	2,57	10,80	4,83	2,24	10,30	5,22	1,97	9,60	5,09	1,89	9,00	4,95	1,82
2	13,50	3,74	3,61	13,00	3,96	3,28	12,40	4,18	2,97	11,90	4,40	2,70	10,80	4,46	2,42	9,80	4,51	2,17
7	16,00	3,21	4,98	16,00	3,74	4,28	16,00	4,27	3,75	16,00	4,80	3,33	15,20	5,11	2,97	14,50	5,41	2,68
25	16,00	2,31	6,93	16,00	2,69	5,95	16,00	3,07	5,21	16,00	3,45	4,64	16,00	3,67	4,36	15,90	3,89	4,09

Aquarea High Performance Bi-bloc H Generation Single phase. Heating and Cooling · R410A

WH-UD12HE5

Tamb	CC	IP	EER	CC	IP	EER	CC	IP	EER
LWC	7	7	7	14	14	14	18	18	18
16	7,86	1,18	6,66	13,15	1,40	9,39	10,00	1,73	5,78
25	12,08	2,90	4,17	15,70	2,05	7,66	10,00	1,97	5,08
35	10,00	3,56	2,81	12,00	2,67	4,49	10,00	2,40	4,17
43	7,80	3,80	2,05	11,10	3,19	3,48	8,00	2,85	2,81

WH-UD16HE5

Tamb	CC	IP	EER	CC	IP	EER	CC	IP	EER
LWC	7	7	7	14	14	14	18	18	18
16	9,20	1,62	5,68	16,40	2,58	6,36	12,20	2,45	4,98
25	14,40	3,92	3,67	19,20	3,83	5,01	12,20	2,79	4,37
35	12,20	4,76	2,56	15,00	4,98	3,01	12,20	2,96	4,12
43	7,75	3,40	2,28	13,80	5,95	2,32	9,70	4,00	2,43

Tamb: Ambient Temperature (°C). LWC: Leaving Water Condenser Temperature (°C). HC: Heating Capacity (kW). CC: Cooling Capacity (kW). IP: Input Power (kW). This data is measured by Panasonic in accordance with EN14511-2 standard. This data is for reference purpose only, and does not guarantee the performance.

Heating and cooling capacity tables

Based on outlet temperature and outside temperature.

Aquarea High Performance Bi-bloc H Generation Three phase. Heating and Cooling - R410A

WH-UD09HE8

Tamb	HC	IP	COP	HC	IP	COP	HC	IP	COP	HC	IP	COP	HC	IP	COP	HC	IP	COP
LWC	30	30	30	35	35	35	40	40	40	45	45	45	50	50	50	55	55	55
-15	8,65	3,06	2,83	8,30	3,21	2,59	7,95	3,41	2,33	7,60	3,61	2,11	7,15	3,71	1,93	6,70	3,81	1,76
-7	9,35	2,91	3,21	9,00	3,16	2,85	8,85	3,54	2,50	8,70	3,92	2,22	8,30	3,89	2,13	7,90	3,86	2,05
2	9,31	2,35	3,96	9,00	2,51	3,59	9,00	2,78	3,24	9,00	3,05	2,95	8,90	3,49	2,55	8,80	3,94	2,23
7	9,00	1,54	5,84	9,00	1,86	4,84	9,00	2,16	4,17	9,00	2,46	3,66	9,00	2,76	3,26	9,00	3,06	2,94
25	9,00	1,05	8,57	9,00	1,24	7,26	8,73	1,44	6,06	8,46	1,64	5,16	8,28	1,82	4,55	8,10	2,00	4,05

WH-UD12HE8

Tamb	HC	IP	COP	HC	IP	COP	HC	IP	COP	HC	IP	COP	HC	IP	COP	HC	IP	COP
LWC	30	30	30	35	35	35	40	40	40	45	45	45	50	50	50	55	55	55
-15	9,30	3,46	2,69	8,90	3,62	2,46	8,50	3,79	2,24	8,10	3,95	2,05	7,50	4,05	1,85	7,00	4,16	1,68
-7	10,40	3,37	3,09	10,00	3,66	2,73	9,60	3,95	2,43	9,20	4,24	2,17	8,70	4,26	2,04	8,20	4,27	1,92
2	11,80	3,10	3,81	11,40	3,31	3,44	11,00	3,53	3,12	10,60	3,74	2,83	9,80	3,94	2,49	9,10	4,14	2,20
7	12,00	2,10	5,71	12,00	2,53	4,74	12,00	2,96	4,05	12,00	3,39	3,54	12,00	3,78	3,17	12,00	4,16	2,88
25	12,00	1,38	8,70	12,00	1,66	7,23	11,80	1,94	6,08	11,70	2,23	5,25	11,50	2,49	4,62	11,40	2,74	4,16

WH-UD16HE8

Tamb	HC	IP	COP	HC	IP	COP	HC	IP	COP	HC	IP	COP	HC	IP	COP	HC	IP	COP
LWC	30	30	30	35	35	35	40	40	40	45	45	45	50	50	50	55	55	55
-15	10,60	4,09	2,59	10,30	4,38	2,35	10,00	4,67	2,14	9,70	4,96	1,96	8,80	4,94	1,78	7,90	4,91	1,61
-7	11,90	4,03	2,95	11,40	4,43	2,57	10,80	4,83	2,24	10,30	5,22	1,97	9,60	5,09	1,89	9,00	4,95	1,82
2	13,50	3,74	3,61	13,00	3,96	3,28	12,40	4,18	2,97	11,90	4,40	2,70	10,80	4,46	2,42	9,80	4,51	2,17
7	16,00	3,21	4,98	16,00	3,74	4,28	16,00	4,27	3,75	16,00	4,80	3,33	15,20	5,11	2,97	14,50	5,41	2,68
25	16,00	2,31	6,93	16,00	2,69	5,95	16,00	3,07	5,21	16,00	3,45	4,64	16,00	3,67	4,36	15,90	3,89	4,09

Aquarea High Performance Bi-bloc H Generation Three phase. Heating and Cooling - R410A

WH-UD09HE8

Tamb	CC	IP	EER	CC	IP	EER	CC	IP	EER
LWC	7	7	7	14	14	14	18	18	18
16	7,50	1,15	6,52	9,10	1,20	7,58	7,00	1,13	6,19
25	8,35	1,77	4,72	10,90	1,78	6,12	7,00	1,24	5,65
35	7,00	2,23	3,14	8,30	2,32	3,58	7,00	1,52	4,61
43	5,52	2,54	2,17	7,69	2,77	2,78	5,60	1,80	3,11

WH-UD12HE8

Tamb	CC	IP	EER	CC	IP	EER	CC	IP	EER
LWC	7	7	7	14	14	14	18	18	18
16	7,86	1,18	6,66	13,15	1,40	9,39	10,00	1,73	5,78
25	12,08	2,90	4,17	15,70	2,05	7,66	10,00	1,97	5,08
35	10,00	2,56	3,91	12,00	2,67	4,49	10,00	2,40	4,17
43	7,80	3,80	2,05	11,10	3,19	3,48	8,00	2,85	2,81

WH-UD16HE8

Tamb	CC	IP	EER	CC	IP	EER	CC	IP	EER
LWC	7	7	7	14	14	14	18	18	18
16	9,20	1,62	5,68	16,40	2,58	6,36	12,20	2,45	4,98
25	14,40	3,92	3,67	19,20	3,83	5,01	12,20	2,79	4,37
35	12,20	4,76	2,56	15,00	4,98	3,01	12,20	2,96	4,12
43	7,75	3,40	2,28	13,80	5,95	2,32	9,70	4,00	2,43

Tamb: Ambient Temperature [°C]. LWC: Leaving Water Condenser Temperature [°C]. HC: Heating Capacity (kW). CC: Cooling Capacity (kW). IP: Input Power (kW). This data is measured by Panasonic in accordance with EN14511-2 standard. This data is for reference purpose only, and does not guarantee the performance.

Aquarea High Performance Mono-bloc J Generation Single phase. Heating and Cooling - MDC - R32

WH-MDC05J3E5

Tamb	HC	IP	COP	HC	IP	COP	HC	IP	COP	HC	IP	COP	HC	IP	COP
LWC	25	25	25	35	35	35	45	45	45	55	55	55	60	60	60
-20	4,37	1,73	2,53	4,16	2,03	2,05	3,84	2,37	1,62	3,43	2,64	1,30	—	—	—
-15	5,13	1,78	2,88	5,00	2,17	2,30	4,75	2,51	1,89	3,70	2,45	1,51	—	—	—
-7	5,17	1,49	3,47	5,00	1,80	2,78	4,80	2,16	2,22	5,00	2,70	1,85	4,68	2,71	1,73
2	5,00	1,11	4,50	5,00	1,40	3,57	5,00	1,81	2,76	5,00	2,20	2,27	4,80	2,40	2,00
7	5,09	0,78	6,53	5,00	0,99	5,05	5,00	1,31	3,82	5,00	1,66	3,01	4,58	1,90	2,41
25	4,96	0,77	6,44	5,04	0,90	5,60	5,31	1,16	4,58	5,61	1,34	4,19	5,15	1,33	3,87

WH-MDC07J3E5

Tamb	HC	IP	COP	HC	IP	COP	HC	IP	COP	HC	IP	COP	HC	IP	COP
LWC	25	25	25	35	35	35	45	45	45	55	55	55	60	60	60
-20	4,86	2,03	2,39	4,66	2,35	1,98	4,44	2,75	1,61	4,23	3,13	1,35	—	—	—
-15	5,80	2,11	2,75	5,60	2,40	2,33	5,30	2,84	1,87	5,00	3,32	1,51	—	—	—
-7	6,76	2,07	3,27	6,80	2,42	2,81	6,30	2,82	2,23	6,30	3,39	1,86	4,74	2,76	1,72
2	6,83	1,66	4,11	7,00	2,06	3,40	6,85	2,50	2,74	6,30	2,92	2,16	4,80	2,40	2,00
7	7,32	1,19	6,15	7,00	1,47	4,76	7,00	1,96	3,57	7,00	2,48	2,82	6,18	2,44	2,53
25	6,80	0,64	10,63	6,67	0,93	7,17	6,79	1,38	4,92	6,70	1,80	3,72	6,22	1,78	3,49

WH-MDC09J3E5

Tamb	HC	IP	COP	HC	IP	COP	HC	IP	COP	HC	IP	COP	HC	IP	COP
LWC	25	25	25	35	35	35	45	45	45	55	55	55	60	60	60
-20	5,33	2,36	2,26	6,43	3,60	1,79	5,78	3,83	1,51	4,83	3,64	1,33	—	—	—
-15	7,76	3,20	2,43	7,60	3,41	2,23	7,00	3,71	1,89	5,60	3,80	1,47	—	—	—
-7	7,39	2,45	3,02	7,50	2,85	2,63	7,30	3,37	2,17	7,00	3,89	1,80	6,44	3,67	1,75
2	7,38	1,89	3,90	7,45	2,38	3,13	7,00	2,85	2,46	7,00	3,30	2,12	5,46	2,72	2,01
7	9,15	1,59	5,75	9,00	2,01	4,48	9,00	2,61	3,45	8,95	3,22	2,78	7,25	2,87	2,53
25	8,02	0,98	8,18	7,88	1,32	5,97	8,46	1,86	4,55	7,60	2,03	3,74	6,30	1,87	3,37

Aquarea High Performance Mono-bloc J Generation Single phase. Heating and Cooling - MDC - R32

WH-MDC05J3E5

Tamb	CC	IP	EER	CC	IP	EER	CC	IP	EER
LWC	7	7	7	14	14	14	18	18	18
16	5,18	0,82	6,32	6,17	0,84	7,35	5,78	0,60	9,63
25	5,38	1,22	4,41	6,64	1,25	5,31	5,55	0,78	7,12
35	5,00	1,54	3,25	5,86	1,61	3,64	5,00	0,99	5,05
43	4,19	1,85	2,26	5,36	1,92	2,79	4,37	1,30	3,36

WH-MDC07J3E5

Tamb	CC	IP	EER	CC	IP	EER	CC	IP	EER
LWC	7	7	7	14	14	14	18	18	18
16	5,38	0,83	6,48	6,69	0,85	7,87	7,65	0,76	10,07
25	6,96	1,82	3,82	9,06	1,98	4,58	7,58	1,23	6,16
35	7,00	2,29	3,06	8,37	2,47	3,39	7,00	1,48	4,73
43	5,60	2,55	2,20	6,87	2,58	2,66	6,10	1,88	3,24

WH-MDC09J3E5

Tamb	CC	IP	EER	CC	IP	EER	CC	IP	EER
LWC	7	7	7	14	14	14	18	18	18
16	6,89	1,21	5,69	8,65	1,23	7,03	9,82	1,19	8,25
25	9,50	2,84	3,35	11,55	3,06	3,77	9,68	1,82	5,32
35	9,00	3,32	2,71	10,10	3,51	2,88	9,00	2,12	4,25
43	5,42	2,56	2,12	6,56	2,56	2,56	7,40	2,56	2,89

Tamb: Ambient Temperature [°C]. LWC: Leaving Water Condenser Temperature [°C]. HC: Heating Capacity [kW]. CC: Cooling Capacity [kW]. IP: Input Power [kW]. This data is measured by Panasonic in accordance with EN14511-2 standard. This data is for reference purpose only, and does not guarantee the performance.

Heating and cooling capacity tables

Based on outlet temperature and outside temperature.

Aquarea High Performance Mono-bloc H Generation Single phase. Heating and Cooling - MDC · R410A

WH-MDC12H6E5																		
Tamb	HC	IP	COP	HC	IP	COP	HC	IP	COP	HC	IP	COP	HC	IP	COP	HC	IP	COP
LWC	30	30	30	35	35	35	40	40	40	45	45	45	50	50	50	55	55	55
-15	9,30	3,46	2,69	8,90	3,62	2,46	8,50	3,79	2,24	8,10	3,95	2,05	—	—	—	7,00	4,10	1,71
-7	10,40	3,37	3,09	10,00	3,66	2,73	9,60	3,95	2,43	9,20	4,24	2,17	—	—	—	8,20	4,21	1,95
2	11,80	3,10	3,81	11,40	3,31	3,44	11,00	3,53	3,12	10,60	3,74	2,83	—	—	—	9,10	4,08	2,23
7	12,00	2,10	5,71	12,00	2,53	4,74	12,00	2,96	4,05	12,00	3,39	3,54	—	—	—	12,00	4,10	2,93
12	12,00	1,38	8,70	12,00	1,66	7,23	11,80	1,94	6,08	11,70	2,23	5,25	—	—	—	11,40	2,74	4,16

WH-MDC16H6E5																		
Tamb	HC	IP	COP	HC	IP	COP	HC	IP	COP	HC	IP	COP	HC	IP	COP	HC	IP	COP
LWC	30	30	30	35	35	35	40	40	40	45	45	45	50	50	50	55	55	55
-15	10,60	4,09	2,59	10,30	4,38	2,35	10,00	4,67	2,14	9,70	4,96	1,96	7,90	4,84	1,63	—	—	—
-7	11,90	4,03	2,95	11,40	4,43	2,57	10,80	4,83	2,24	10,30	5,22	1,97	9,00	4,88	1,84	—	—	—
2	13,50	13,74	0,98	13,00	3,96	3,28	12,40	4,18	2,97	11,90	4,40	2,70	9,80	4,44	2,21	—	—	—
7	16,00	3,21	4,98	16,00	3,74	4,28	16,00	4,27	3,75	16,00	4,80	3,33	14,50	5,33	2,72	—	—	—
12	16,00	2,31	6,93	16,00	2,69	5,95	16,00	3,07	5,21	16,00	3,45	4,64	15,90	3,89	4,09	—	—	—

Aquarea High Performance Mono-bloc H Generation Single phase. Heating and Cooling - MDC · R410A

WH-MDC12H6E5									
Tamb	CC	IP	EER	CC	IP	EER	CC	IP	EER
LWC	7	7	7	14	14	14	18	18	18
16	7,86	1,18	6,66	13,15	2,05	6,41	10,00	1,73	5,78
25	12,08	2,90	4,17	15,70	3,05	5,15	10,00	1,97	5,08
35	10,00	3,56	2,81	12,00	3,67	3,27	10,00	2,15	4,65
43	7,80	3,80	2,05	11,10	3,19	3,48	8,00	2,85	2,81

WH-MDC16H6E5									
Tamb	CC	IP	EER	CC	IP	EER	CC	IP	EER
LWC	7	7	7	14	14	14	18	18	18
16	9,20	1,62	5,68	16,40	2,58	6,36	12,20	2,45	4,98
25	14,40	3,92	3,67	19,20	3,83	5,01	12,20	2,79	4,37
35	12,20	4,76	2,56	15,00	4,98	3,01	12,20	2,96	4,12
43	7,75	3,40	2,28	13,80	5,95	2,32	9,70	4,00	2,43

Aquarea T-CAP Bi-bloc K Generation Single phase. Heating and Cooling · R32

WH-UXZ09KE5									
Tamb	HC	IP	COP	HC	IP	COP	HC	IP	COP
LWC	35	35	35	45	45	45	55	55	55
-15	9,00	3,45	2,61	9,00	4,30	2,09	9,00	4,95	1,82
-7	9,00	3,00	3,00	9,00	3,82	2,36	9,00	4,28	2,10
2	9,00	2,44	3,69	9,00	3,05	2,95	9,00	3,90	2,31
7	9,00	1,79	5,03	9,00	2,42	3,72	9,00	2,93	3,07

WH-UXZ12KE5									
Tamb	HC	IP	COP	HC	IP	COP	HC	IP	COP
LWC	35	35	35	45	45	45	55	55	55
-15	12,00	4,90	2,45	11,00	5,38	2,04	10,50	6,20	1,69
-7	12,00	4,41	2,72	12,00	5,54	2,17	12,00	6,00	2,00
2	12,00	3,49	3,44	12,00	4,25	2,82	12,00	5,24	2,29
7	12,10	2,50	4,84	12,10	3,38	3,58	12,10	3,98	3,04

Aquarea T-CAP Bi-bloc K Generation Single phase. Heating and Cooling · R32

WH-UXZ09KE5					
Tamb	CC	IP	EER	CC	IP
LWC	7	7	7	18	18
35	8,80	2,83	3,11	8,80	1,90
43	—	—	—	—	—

WH-UXZ12KE5					
Tamb	CC	IP	EER	CC	IP
LWC	7	7	7	18	18
35	10,70	4,00	2,68	10,70	2,73
43	—	—	—	—	—

Tamb: Ambient Temperature [°C]. LWC: Leaving Water Condenser Temperature [°C]. HC: Heating Capacity [kW]. CC: Cooling Capacity [kW]. IP: Input Power [kW]. This data is measured by Panasonic in accordance with EN14511-2 standard. This data is for reference purpose only, and does not guarantee the performance.

Aquarea T-CAP Bi-bloc H Generation Single phase / Three phase. Heating and Cooling - R410A

WH-UX09HE5																		
Tamb	HC	IP	COP	HC	IP	COP	HC	IP	COP	HC	IP	COP	HC	IP	COP	HC	IP	COP
LWC	30	30	30	35	35	35	40	40	40	45	45	45	50	50	50	55	55	55
-15	9,00	3,24	2,78	9,00	3,51	2,56	9,00	3,91	2,30	9,00	4,30	2,09	9,00	4,73	1,90	9,00	5,16	1,74
-7	9,00	2,71	3,32	9,00	3,16	2,85	9,00	3,62	2,49	9,00	4,07	2,21	9,00	4,27	2,11	9,00	4,46	2,02
2	9,00	2,36	3,81	9,00	2,51	3,59	9,00	2,78	3,24	9,00	3,05	2,95	9,00	3,56	2,53	9,00	4,07	2,21
7	9,00	1,64	5,49	9,00	1,86	4,84	9,00	2,16	4,17	9,00	2,46	3,66	9,00	2,76	3,26	9,00	3,06	2,94
25	13,60	1,50	9,07	13,60	1,71	7,95	13,20	1,93	6,84	12,80	2,14	5,98	12,00	2,41	4,98	11,20	2,67	4,19
WH-UX12HE5																		
Tamb	HC	IP	COP	HC	IP	COP	HC	IP	COP	HC	IP	COP	HC	IP	COP	HC	IP	COP
LWC	30	30	30	35	35	35	40	40	40	45	45	45	50	50	50	55	55	55
-15	12,00	4,75	2,53	12,00	4,96	2,42	12,00	5,41	2,22	11,00	5,38	2,04	10,80	5,82	1,86	10,50	6,26	1,68
-7	12,00	3,85	3,12	12,00	4,41	2,72	12,00	4,98	2,41	12,00	5,54	2,17	12,00	5,90	2,03	12,00	6,26	1,92
2	12,00	3,19	3,76	12,00	3,49	3,44	12,00	3,87	3,10	12,00	4,25	2,82	12,00	4,86	2,47	12,00	5,47	2,19
7	12,00	2,18	5,50	12,00	2,53	4,74	12,00	2,96	4,05	12,00	3,39	3,54	12,00	3,78	3,17	12,00	4,16	2,88
25	13,60	1,55	8,77	13,60	1,76	7,73	13,40	2,10	6,38	13,20	2,43	5,43	12,60	2,66	4,74	12,00	2,89	4,15
WH-UX09HE8																		
Tamb	HC	IP	COP	HC	IP	COP	HC	IP	COP	HC	IP	COP	HC	IP	COP	HC	IP	COP
LWC	30	30	30	35	35	35	40	40	40	45	45	45	50	50	50	55	55	55
-15	9,00	3,24	2,78	9,00	3,51	2,56	9,00	3,91	2,30	9,00	4,30	2,09	9,00	4,73	1,90	9,00	5,16	1,74
-7	9,00	2,71	3,32	9,00	3,16	2,85	9,00	3,62	2,49	9,00	4,07	2,21	9,00	4,27	2,11	9,00	4,46	2,02
2	9,00	2,36	3,81	9,00	2,51	3,59	9,00	2,78	3,24	9,00	3,05	2,95	9,00	3,56	2,53	9,00	4,07	2,21
7	9,00	1,64	5,49	9,00	1,86	4,84	9,00	2,16	4,17	9,00	2,46	3,66	9,00	2,76	3,26	9,00	3,06	2,94
25	13,60	1,50	9,07	13,60	1,71	7,95	13,20	1,93	6,84	12,80	2,14	5,98	12,00	2,41	4,98	11,20	2,67	4,19
WH-UX12HE8																		
Tamb	HC	IP	COP	HC	IP	COP	HC	IP	COP	HC	IP	COP	HC	IP	COP	HC	IP	COP
LWC	30	30	30	35	35	35	40	40	40	45	45	45	50	50	50	55	55	55
-15	12,00	4,75	2,53	12,00	4,96	2,42	12,00	5,41	2,22	12,00	5,86	2,05	11,80	6,24	1,89	11,60	6,62	1,75
-7	12,00	3,85	3,12	12,00	4,41	2,72	12,00	4,98	2,41	12,00	5,54	2,17	12,00	5,90	2,03	12,00	6,26	1,92
2	12,00	3,19	3,76	12,00	3,49	3,44	12,00	3,87	3,10	12,00	4,25	2,82	12,00	4,86	2,47	12,00	5,47	2,19
7	12,00	2,18	5,50	12,00	2,53	4,74	12,00	2,96	4,05	12,00	3,39	3,54	12,00	3,78	3,17	12,00	4,16	2,88
25	13,60	1,55	8,77	13,60	1,76	7,73	13,40	2,10	6,38	13,20	2,43	5,43	12,60	2,66	4,74	12,00	2,89	4,15
WH-UX16HE8																		
Tamb	HC	IP	COP	HC	IP	COP	HC	IP	COP	HC	IP	COP	HC	IP	COP	HC	IP	COP
LWC	30	30	30	35	35	35	40	40	40	45	45	45	50	50	50	55	55	55
-15	16,00	6,30	2,54	16,00	6,89	2,32	16,00	7,45	2,15	16,00	8,10	1,98	16,00	8,48	1,89	15,20	8,96	1,70
-7	16,00	5,85	2,74	16,00	6,42	2,49	16,00	7,00	2,29	16,00	7,57	2,11	16,00	8,10	1,98	16,00	8,62	1,86
2	16,00	4,67	3,43	16,00	5,21	3,07	16,00	5,74	2,79	16,00	6,31	2,54	16,00	6,90	2,32	16,00	7,50	2,13
7	16,00	3,35	4,78	16,00	3,74	4,28	16,00	4,30	3,72	16,00	4,80	3,33	16,00	5,43	2,95	16,00	5,91	2,71
16	16,00	2,59	6,18	16,00	3,18	5,03	16,00	3,71	4,31	16,00	4,27	3,75	16,00	4,86	3,29	16,00	5,22	3,07
25	16,00	2,02	7,92	16,00	2,58	6,20	16,00	2,91	5,50	16,00	3,36	4,76	16,00	3,74	4,28	16,00	4,00	4,00

Aquarea T-CAP Bi-bloc H Generation Single phase / Three phase. Heating and Cooling - R410A

Outdoor		WH-UX09HE5									WH-UX12HE5								
Tamb	CC	IP	EER	CC	IP	EER	CC	IP	EER	CC	IP	EER	CC	IP	EER	CC	IP	EER	
LWC	7	7	7	14	14	14	18	18	18	7	7	7	14	14	14	18	18	18	
18	7,00	1,36	5,15	8,55	1,41	6,06	7,00	1,00	7,00	10,00	1,75	5,71	13,20	1,96	6,73	10,00	1,40	7,14	
25	7,65	1,91	4,01	11,10	1,98	5,61	7,00	1,10	6,36	11,20	2,67	4,19	16,50	3,01	5,48	10,00	1,60	6,25	
35	7,00	2,21	3,17	9,23	2,37	3,89	7,00	1,35	5,19	10,00	3,56	2,81	12,55	3,63	3,46	10,00	1,95	5,13	
43	6,25	2,66	2,35	8,55	2,71	3,15	5,60	1,60	3,50	8,00	3,35	2,39	10,00	3,46	2,89	8,00	2,30	3,48	
Outdoor		WH-UX09HE8						WH-UX12HE8						WH-UX16HE8					
Tamb	CC	IP	EER	CC	IP	EER	CC	IP	EER	CC	IP	EER	CC	IP	EER	CC	IP	EER	
LWC	7	7	7	18	18	18	7	7	7	18	18	18	7	7	7	18	18	18	
18	7,00	1,36	5,15	—	—	—	7,50	1,41	5,32	—	—	—	8,50	1,70	5,00	10,00	1,70	5,88	
25	7,65	1,91	4,01	—	—	—	8,90	2,16	4,12	—	—	—	14,00	4,00	3,50	14,00	2,94	4,76	
35	7,00	2,21	3,17	—	—	—	10,00	3,56	2,81	—	—	—	12,20	4,76	2,56	12,20	3,50	3,49	
43	6,25	2,66	2,35	—	—	—	8,00	3,01	2,66	—	—	—	7,10	3,31	2,15	9,80	3,31	2,96	

Tamb: Ambient Temperature [°C]. LWC: Leaving Water Condenser Temperature [°C]. HC: Heating Capacity (kW). CC: Cooling Capacity (kW). IP: Input Power (kW). This data is measured by Panasonic in accordance with EN14511-2 standard. This data is for reference purpose only, and does not guarantee the performance.

Heating and cooling capacity tables

Based on outlet temperature and outside temperature.

Aquarea T-CAP Bi-bloc H Generation Three phase. Super Quiet outdoor unit. Heating and Cooling - SQC · R410A

WH-UQ09HE8

Tamb	HC	IP	COP	HC	IP	COP	HC	IP	COP	HC	IP	COP	HC	IP	COP	HC	IP	COP
LWC	30	30	30	35	35	35	40	40	40	45	45	45	50	50	50	55	55	55
-15	9,00	3,24	2,78	9,00	3,51	2,56	9,00	3,91	2,30	9,00	4,30	2,09	9,00	4,73	1,90	9,00	5,16	1,74
-7	9,00	2,71	3,32	9,00	3,16	2,85	9,00	3,62	2,49	9,00	4,07	2,21	9,00	4,27	2,11	9,00	4,46	2,02
2	9,00	2,36	3,81	9,00	2,51	3,59	9,00	2,78	3,24	9,00	3,05	2,95	9,00	3,56	2,53	9,00	4,07	2,21
7	9,00	1,64	5,49	9,00	1,86	4,84	9,00	2,16	4,17	9,00	2,46	3,66	9,00	2,76	3,26	9,00	3,06	2,94
25	13,60	1,50	9,07	13,60	1,71	7,95	13,20	1,93	6,84	12,80	2,14	5,98	12,00	2,41	4,98	11,20	2,67	4,19

WH-UQ12HE8

Tamb	HC	IP	COP	HC	IP	COP	HC	IP	COP	HC	IP	COP	HC	IP	COP	HC	IP	COP
LWC	30	30	30	35	35	35	40	40	40	45	45	45	50	50	50	55	55	55
-15	12,00	4,75	2,53	12,00	4,96	2,42	12,00	5,41	2,22	12,00	5,86	2,05	11,80	6,24	1,89	11,60	6,62	1,75
-7	12,00	3,85	3,12	12,00	4,41	2,72	12,00	4,98	2,41	12,00	5,54	2,17	12,00	5,90	2,03	12,00	6,26	1,92
2	12,00	3,19	3,76	12,00	3,49	3,44	12,00	3,87	3,10	12,00	4,25	2,82	12,00	4,86	2,47	12,00	5,47	2,19
7	12,00	2,18	5,50	12,00	2,53	4,74	12,00	2,96	4,05	12,00	3,39	3,54	12,00	3,78	3,17	12,00	4,16	2,88
25	13,60	1,55	8,77	13,60	1,76	7,73	13,40	2,10	6,38	13,20	2,43	5,43	12,60	2,66	4,74	12,00	2,89	4,15

WH-UQ16HE8

Tamb	HC	IP	COP	HC	IP	COP	HC	IP	COP	HC	IP	COP	HC	IP	COP	HC	IP	COP
LWC	30	30	30	35	35	35	40	40	40	45	45	45	50	50	50	55	55	55
-15	16,00	6,30	2,54	16,00	6,89	2,32	16,00	7,45	2,15	16,00	8,10	1,98	16,00	8,48	1,89	15,20	8,96	1,70
-7	16,00	5,85	2,74	16,00	6,42	2,49	16,00	7,00	2,29	16,00	7,57	2,11	16,00	8,10	1,98	16,00	8,62	1,86
2	16,00	4,67	3,43	16,00	5,21	3,07	16,00	5,74	2,79	16,00	6,31	2,54	16,00	6,90	2,32	16,00	7,50	2,13
7	16,00	3,35	4,78	16,00	3,74	4,28	16,00	4,30	3,72	16,00	4,80	3,33	16,00	5,43	2,95	16,00	5,91	2,71
16	16,00	2,59	6,18	16,00	3,18	5,03	16,00	3,71	4,31	16,00	4,27	3,75	16,00	4,86	3,29	16,00	5,22	3,07
25	16,00	2,02	7,92	16,00	2,58	6,20	16,00	2,91	5,50	16,00	3,36	4,76	16,00	3,74	4,28	16,00	4,00	4,00

Aquarea T-CAP Bi-bloc H Generation Three phase. Super Quiet outdoor unit. Heating and Cooling - SQC · R410A

WH-UQ09HE8

Tamb	CC	IP	EER	CC	IP	EER
LWC	7	7	7	18	18	18
18	7,00	1,36	5,15	—	—	—
25	7,65	1,91	4,01	—	—	—
35	7,00	2,21	3,17	—	—	—
43	6,25	2,66	2,35	—	—	—

WH-UQ12HE8

Tamb	CC	IP	EER	CC	IP	EER
LWC	7	7	7	18	18	18
18	7,50	1,41	5,32	—	—	—
25	8,90	2,16	4,12	—	—	—
35	10,00	3,56	2,81	—	—	—
43	8,00	3,01	2,66	—	—	—

WH-UQ16HE8

Tamb	CC	IP	EER	CC	IP	EER
LWC	7	7	7	18	18	18
18	8,50	1,70	5,00	10,00	1,70	5,88
25	14,00	4,00	3,50	14,00	2,94	4,76
35	12,20	4,76	2,56	12,20	3,50	3,49
43	7,10	3,31	2,15	9,80	3,31	2,96

Tamb: Ambient Temperature (°C). LWC: Leaving Water Condenser Temperature (°C). HC: Heating Capacity (kW). CC: Cooling Capacity (kW). IP: Input Power (kW). This data is measured by Panasonic in accordance with EN14511-2 standard. This data is for reference purpose only, and does not guarantee the performance.

Aquarea T-CAP Mono-bloc J Generation Single phase / Three phase. Heating and Cooling - MXC · R32

WH-MXC09J3E5

Tamb	HC	IP	COP	HC	IP	COP	HC	IP	COP	HC	IP	COP	HC	IP	COP
LWC	25	25	25	35	35	35	45	45	45	55	55	55	60	60	60
-20	9,00	3,44	2,62	9,00	3,95	2,28	9,00	4,65	1,94	7,90	5,58	1,42	—	—	—
-15	9,00	2,98	3,02	9,00	3,41	2,64	9,00	4,04	2,23	9,00	4,83	1,86	8,70	5,37	1,62
-7	10,50	2,72	3,86	9,00	2,92	3,08	9,00	3,54	2,54	9,00	4,24	2,12	9,00	4,62	1,95
2	10,80	2,14	5,05	9,00	2,36	3,81	9,00	2,91	3,09	9,00	3,55	2,54	9,00	4,05	2,22
7	9,00	1,38	6,52	9,00	1,77	5,08	9,00	2,37	3,80	9,00	2,92	3,08	9,00	3,29	2,74
25	9,00	0,77	11,69	9,00	1,00	9,00	10,00	1,67	5,99	10,00	2,28	4,39	11,00	2,86	3,85

WH-MXC12J6E5

Tamb	HC	IP	COP	HC	IP	COP	HC	IP	COP	HC	IP	COP	HC	IP	COP
LWC	25	25	25	35	35	35	45	45	45	55	55	55	60	60	60
-20	12,00	5,02	2,39	12,00	5,80	2,07	11,00	5,95	1,85	10,00	6,50	1,54	—	—	—
-15	12,00	4,14	2,90	12,00	4,83	2,48	11,00	5,20	2,12	10,50	6,00	1,75	8,90	6,30	1,41
-7	13,50	4,30	3,14	12,00	4,25	2,82	12,00	5,02	2,39	12,00	6,00	2,00	11,00	6,30	1,75
2	14,50	3,23	4,49	12,00	3,40	3,53	12,00	4,20	2,86	12,00	4,95	2,42	12,00	5,77	2,08
7	12,00	2,00	6,00	12,00	2,50	4,80	12,00	3,24	3,70	12,00	3,94	3,05	12,00	4,52	2,65
25	12,00	1,20	10,00	12,00	1,49	8,05	12,00	2,10	5,71	12,00	2,75	4,36	12,00	3,11	3,86

WH-MXC09J3E8

Tamb	HC	IP	COP	HC	IP	COP	HC	IP	COP	HC	IP	COP	HC	IP	COP
LWC	25	25	25	35	35	35	45	45	45	55	55	55	60	60	60
-20	9,00	3,44	2,62	9,00	3,95	2,28	9,00	4,65	1,94	7,90	5,58	1,42	—	—	—
-15	9,00	2,98	3,02	9,00	3,41	2,64	9,00	4,04	2,23	9,00	4,83	1,86	8,70	5,37	1,62
-7	10,50	2,72	3,86	9,00	2,92	3,08	9,00	3,54	2,54	9,00	4,24	2,12	9,00	4,62	1,95
2	10,80	2,14	5,05	9,00	2,36	3,81	9,00	2,91	3,09	9,00	3,55	2,54	9,00	4,05	2,22
7	9,00	1,38	6,52	9,00	1,77	5,08	9,00	2,37	3,80	9,00	2,92	3,08	9,00	3,29	2,74
25	9,00	0,77	11,69	9,00	1,00	9,00	10,00	1,67	5,99	10,00	2,28	4,39	11,00	2,86	3,85

WH-MXC12J9E8

Tamb	HC	IP	COP	HC	IP	COP	HC	IP	COP	HC	IP	COP	HC	IP	COP
LWC	25	25	25	35	35	35	45	45	45	55	55	55	60	60	60
-20	12,00	5,02	2,39	12,00	5,80	2,07	10,50	5,75	1,83	9,20	5,80	1,59	—	—	—
-15	12,00	4,14	2,90	12,00	4,83	2,48	12,00	5,67	2,12	11,10	6,35	1,75	8,70	6,20	1,40
-7	13,50	4,30	3,14	12,00	4,25	2,82	12,00	5,02	2,39	12,00	6,00	2,00	11,00	6,30	1,75
2	14,50	3,23	4,49	12,00	3,40	3,53	12,00	4,20	2,86	12,00	4,95	2,42	12,00	5,77	2,08
7	12,00	2,00	6,00	12,00	2,50	4,80	12,00	3,24	3,70	12,00	3,94	3,05	12,00	4,52	2,65
25	12,00	1,20	10,00	12,00	1,49	8,05	12,00	2,10	5,71	12,00	2,75	4,36	12,00	3,11	3,86

WH-MXC16J9E8

Tamb	HC	IP	COP	HC	IP	COP	HC	IP	COP	HC	IP	COP	HC	IP	COP
LWC	25	25	25	35	35	35	45	45	45	55	55	55	60	60	60
-20	16,00	7,40	2,16	16,00	8,40	1,90	16,00	10,00	1,60	14,00	10,30	1,36	—	—	—
-15	15,30	6,10	2,51	16,00	6,91	2,32	16,00	8,44	1,90	16,00	9,97	1,60	14,00	10,60	1,32
-7	19,00	6,60	2,88	16,00	6,70	2,39	16,00	7,85	2,04	16,00	9,33	1,71	15,00	9,70	1,55
2	20,60	5,35	3,85	16,00	5,16	3,10	16,00	6,40	2,50	16,00	7,72	2,07	16,00	9,20	1,74
7	16,00	2,80	5,71	16,00	3,54	4,52	16,00	4,55	3,52	16,00	5,60	2,86	15,60	6,50	2,40
25	16,00	1,55	10,32	16,00	2,30	6,96	16,00	3,20	5,00	16,00	4,00	4,00	15,50	4,50	3,44

Aquarea T-CAP Mono-bloc J Generation Single phase / Three phase. Heating and Cooling - MXC · R32

Outdoor		WH-MXC09J3E5									WH-MXC12J6E5																	
Tamb	CC	IP	EER	CC	IP	EER	CC	IP	EER	CC	IP	EER	CC	IP	EER	CC	IP	EER										
LWC	7	7	7	14	14	14	18	18	18	7	7	7	14	14	14	18	18	18										
16	9,00	1,61	5,59	11,00	1,49	7,38	11,40	1,30	8,77	11,40	2,10	5,43	13,60	2,09	6,51	15,00	2,06	7,28										
25	9,00	2,00	4,50	12,60	2,38	5,29	10,50	1,54	6,82	12,00	2,87	4,18	15,70	3,60	4,36	14,00	2,56	5,47										
35	9,00	2,83	3,18	10,90	2,98	3,66	9,00	1,95	4,62	12,00	4,14	2,90	13,60	4,35	3,13	12,00	3,04	3,95										
43	7,20	3,26	2,21	8,70	3,23	2,69	7,30	2,43	3,00	10,30	4,89	2,11	11,80	4,98	2,37	10,40	3,72	2,80										
Outdoor		WH-MXC09J3E8									WH-MXC12J9E8									WH-MXC16J9E8								
Tamb	CC	IP	EER	CC	IP	EER	CC	IP	EER	CC	IP	EER	CC	IP	EER	CC	IP	EER	CC	IP	EER	CC	IP	EER				
LWC	7	7	7	14	14	14	18	18	18	7	7	7	14	14	14	18	18	18	7	7	7	14	14	14	18	18	18	
16	9,00	1,66	5,42	11,00	1,54	7,14	11,40	1,35	8,44	11,40	2,15	5,30	13,60	2,14	6,36	15,00	2,15	6,98	15,00	3,15	4,76	19,00	3,35	5,67	19,00	3,00	6,33	
25	9,00	2,06	4,37	12,60	2,45	5,14	10,50	1,60	6,56	12,00	2,93	4,10	15,70	3,68	4,27	14,00	2,66	5,26	15,00	4,00	3,75	18,00	4,00	4,50	18,00	3,50	5,14	
35	9,00	2,91	3,09	10,90	3,07	3,55	9,00	2,02	4,46	12,00	4,23	2,84	13,60	4,44	3,06	12,00	3,17	3,79	14,50	5,11	2,84	14,50	4,20	3,45	16,00	4,27	3,75	
43	7,20	3,36	2,14	8,70	3,33	2,61	7,30	2,53	2,89	10,30	5,00	2,06	11,80	5,09	2,32	10,40	3,87	2,69	9,50	4,40	2,16	11,50	4,40	2,61	12,50	4,30	2,91	

Tamb: Ambient Temperature (°C). LWC: Leaving Water Condenser Temperature (°C). HC: Heating Capacity (kW). CC: Cooling Capacity (kW). IP: Input Power (kW). This data is measured by Panasonic in accordance with EN14511-2 standard. This data is for reference purpose only, and does not guarantee the performance.

Examples of installations

**Aquarea H and J Generations:
Bivalent with buffer tank and mixing valve**

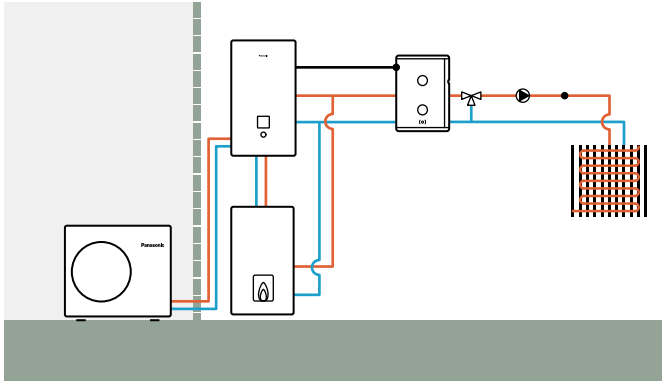

**Aquarea H and J Generations:
Buffer tank with solar and mixing valve**

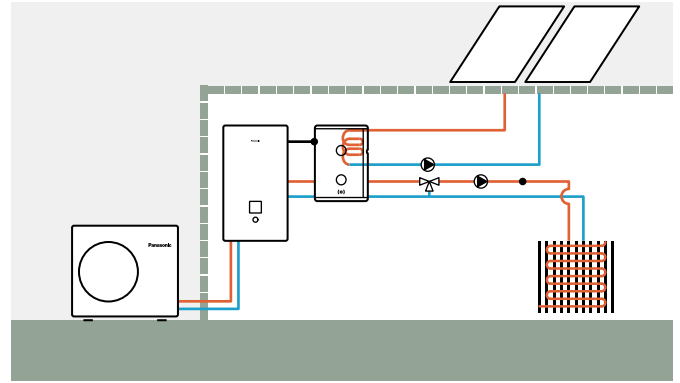

**Aquarea H and J Generations:
2 zones with external kit without buffer tank**

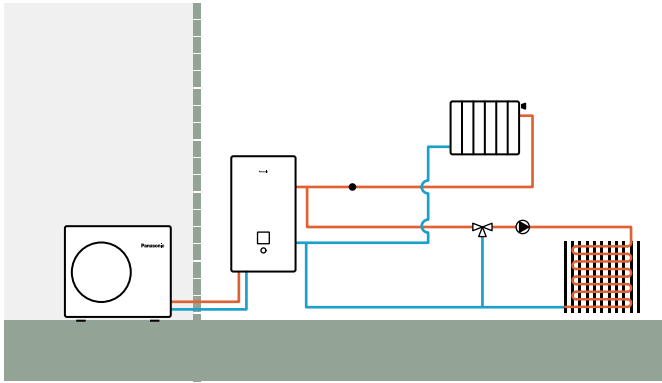

**Aquarea H and J Generations:
2 zones with external kit, buffer tank and swimming pool**

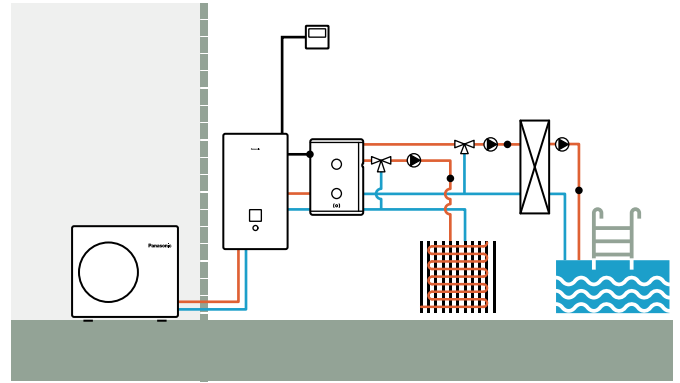

**Aquarea All in One H and J Generations:
2 zones with external kit, without buffer tank**

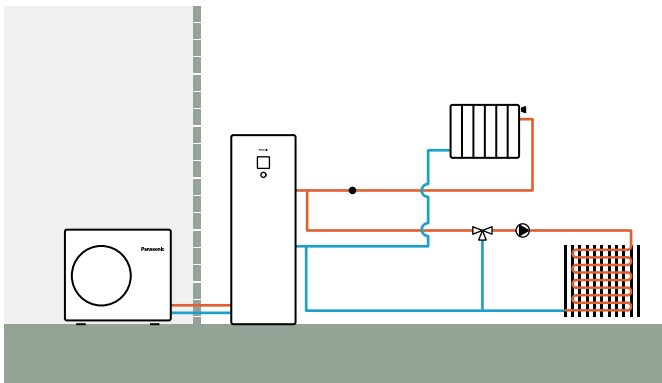

**Aquarea All in One 2 zones H and J Generations:
2 zones built-in, without buffer tank**

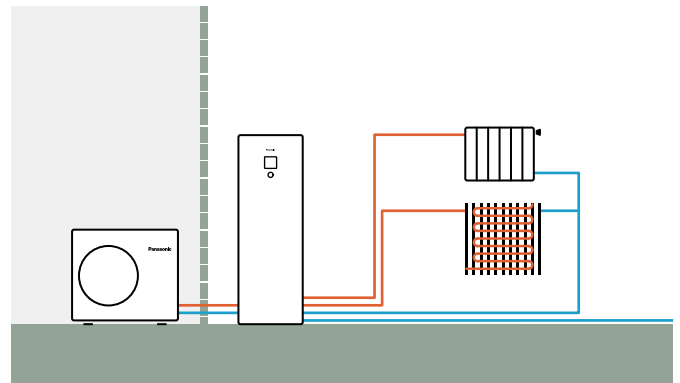

ETHEREA



Panasonic domestic air to air heat pump

Panasonic has developed a range of products designed for you, better than ever before. Above all, it is also a range for air conditioning professionals, such as yourself, thanks to its broad range of products which are capable of conditioning rooms of all sizes – always with optimal efficiency and incomparable ease of installation.

Highlighted features	→ 112
Bringing nature's balance indoors	→ 114
Etherea with nanoe™ X technology	→ 116
Heatcharge. Energy Charge System	→ 118
Wall-mounted TZ super-compact	→ 120
Super-compact units	→ 122
Floor console	→ 124
Panasonic R2 rotary compressor	→ 126
R22 Renewal	→ 128
Welcome to the connected world of Panasonic Comfort Cloud App	→ 130
Voice Control	→ 132
Control and connectivity	→ 134
Domestic air conditioner R32 range	→ 136

Wall-mounted

Heatcharge VZ · R32	→ 138
Etherea · R32	→ 139
TZ super-compact · R32	→ 140
BZ super-compact · R32	→ 141
UZ super-compact · R32	→ 142

More options for your home

Floor console · R32	→ 143
Low static pressure hide-away · R32	→ 144
Free Multi system	→ 145
Multi TZ system	→ 148
Compare solutions	→ 149
Feature comparison	→ 150
Features explained	→ 152
Accessories and control	→ 153

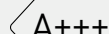
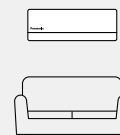

Highlighted features

With innovative design, high efficiency and advanced technologies, such as Panasonic Comfort Cloud App for smart control and nanoe™ X for indoor air quality improvement, the residential range has been designed with you and your clients in mind.



Panasonic air conditioners provide more savings and more comfort.

We believe that going green shouldn't compromise on comfort.

Our super silent air conditioners guarantee clean indoor air to take care of you and your family. For a cleaner living environment, the nanoe™ X helps improve the quality of the indoor air as well as your surroundings. Together, these breakthrough technologies embody Panasonic's Eco Clean Life Innovation - innovations that improve our environment whilst making life as comfortable as possible.

The iF Product Design Awards are among the most prestigious awards for product design excellence. Winning the award thanks to its highly intelligent functionality, the Panasonic Floor console is the ideal air-conditioning system for domestic and commercial applications.



Energy saving



Refrigerant R32.

Our heat pumps containing R32 refrigerant show a drastic reduction in the value of Global Warming Potential (GWP). An important step to reduce greenhouse gases. R32 is also a component refrigerant, making it easy to recycle.



Exceptional seasonal cooling efficiency based on the ErP regulation.

Higher SEER ratings mean greater efficiency and year-round cooling savings!

10,50 SEER



Exceptional seasonal heating efficiency based on the ErP regulation.

Higher SCOP ratings mean greater efficiency and year-round heating savings!

6,20 SCOP



Econavi. Sunlight sensor.

Sunlight Sensor technology can detect and reduce the waste of energy by optimising air conditioner operation according to room conditions. With just one touch of a button, you can save energy.

38%

ECONAVI



Inverter Plus system.

Inverter Plus system classification highlights Panasonic's highest performing systems.

INVERTER+



Inverter.

The Inverter range provides greater efficiency and comfort. Provides more precise temperature control, without highs and lows, and keeps the ambient temperature constant with lower energy consumption and a significant reduction in noise and vibration levels.

INVERTER



Panasonic R2 rotary compressor.

Designed to withstand extreme conditions, it delivers high performance and efficiency.

R2 ROTARY COMPRESSOR

High performance and indoor air quality



nanoe™ X.

Technology with the benefits of hydroxyl radicals has the capacity to inhibit pollutants, viruses, and bacteria to clean and deodorise.

nanoe X



PM2,5 filter.

Particulate matter (PM2,5) can be found suspended in the air, including dust, dirt, smoke and liquid droplets. This filter can catch PM2,5 particles including hazardous pollutants as well as house dust and pollen.

PM2,5 FILTER



Dust collection filter.

This filter collects and retains particles suspended in the air, resulting in cleaner air in the room.

DUST COLLECTION FILTER



Super Quiet.

With Super Quiet technology our devices are quieter than a library (30 dB(A)).

18 dB(A)



Inside cleaning.

This function works to dry-off to inside of indoor unit with nanoe™ X. It can inhibit certain adhered bacteria, viruses and mould up to 99% efficiency.

INSIDE CLEANING ON DEMAND



More comfort with Aerowings.

Direct air flow to the ceiling, creating a shower cooling effect with built-in twin flap.

AEROWINGS



Static pressure up to 7 mmAq.

Low static pressure hide-away RAC with selectable static pressure up to 7 mmAq.

STATIC PRESSURE UP TO 7 mmAq



Filter included.

Low static pressure hide-away RAC with filter included.

STATIC PRESSURE UP TO 7 mmAq



Summer House.

This innovative function keeps the house at 8/10 or 8/15 °C to avoid freezing pipes during the winter. This function is beneficial for summer or weekend homes.

SUMMER HOUSE



Down to -10 °C in cooling mode.

The air conditioner works in cooling mode when the outdoor temperature of -10 °C.

COOLING MODE



Down to -15 °C in heating mode.

The air conditioner works in heat pump mode when the outdoor temperature is as low as -15 °C.

HEATING MODE



R410A/R22 renewal.

The Panasonic renewal system allows good quality existing R410A or R22 pipe work to be re-used whilst installing high efficiency R32 systems.

R22 R410A R32 R22 / R410A RENEWAL



5 Years compressor warranty.

We guarantee the outdoor unit compressors in the entire range for five years.

5 YEARS COMPRESSOR WARRANTY

High connectivity



Domestic integration to S-Link - CZ-CAPRA1.

Can connect RAC range to S-Link. Full control is now possible.

INTEGRATION TO S-LINK



Wi-Fi control.

A next generation system providing user-friendly control of air conditioning or heat pump units from everywhere, using a simple Android™ or iOS smartphone or tablet via Wi-Fi.

WI-FI CONTROL



BMS connectivity.

The communication port can be integrated into the indoor unit and provides easy connection to, and control of, your Panasonic air conditioner to your home or Building Management System.

BMS CONNECTIVITY

Bringing nature's balance indoors



nanoe™ X, technology with the benefits of hydroxyl radicals.

Abundant in nature, hydroxyl radicals (also known as OH radicals) have the capacity to inhibit pollutants, viruses, and bacteria to clean and deodorise. nanoe™ X technology can bring these incredible benefits indoors so that hard surfaces, soft furnishings, and the indoor environment can be a cleaner and more pleasant place to be.



Panasonic's nanoe™ X technology takes this a step further and brings nature's detergent – hydroxyl radicals – indoors to help create an ideal environment

Thanks to the nanoe™ X properties, several types of pollutants can be inhibited such as certain types of bacteria, viruses, mould, allergens, pollen and certain hazardous substances.

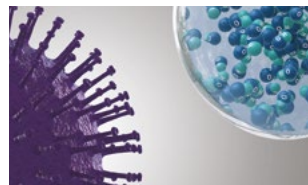

1 | nanoe™ X reliably reaches pollutants.

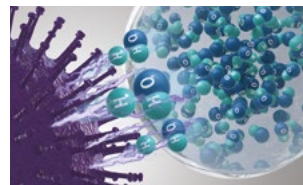

2 | Hydroxyl radicals denature pollutants' proteins.

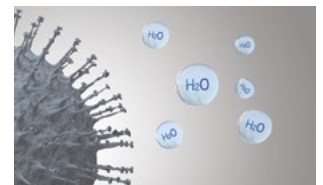

3 | Pollutants activity is inhibited.

What is unique about nanoe™ X?

Effective on fabrics and surfaces.

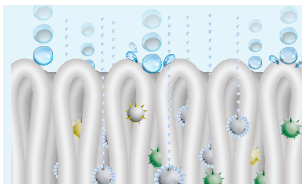

1 | At one billionth of a metre, nanoe™ X is much smaller than steam and can deeply penetrate cloth fabrics to deodorise.

Longer lifespan.



2 | Contained in tiny water particles, nanoe™ X has a long lifespan, which is about 600 seconds, to spread easily around the room.

Huge quantity.



3 | nanoe™ X Generator Mark 3 produces 48 trillion hydroxyl radicals per second. Greater amounts of hydroxyl radicals contained in nanoe™ X lead to higher performance on inhibition of pollutants.

Maintenance-free.

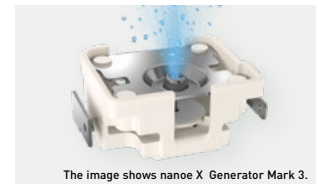

The image shows nanoe™ X Generator Mark 3.

4 | No service and maintenance required. nanoe™ X is a filter free solution that does not require maintenance, as its atomisation electrode is enveloped with water during its generation process and it is made with Titanium.

7 effects of nanoe™ X – Panasonic unique technology

Deodorises

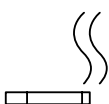

Odours

Capacity to inhibit 5 types of pollutants

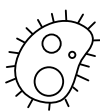

Bacteria and viruses

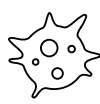

Mould



Allergens



Pollen



Hazardous substances



Skin and hair

* Refer to <https://aircon.panasonic.eu> for more details and validation data.

nanoe™ X, internationally-validated technology in testing facilities.

The effectiveness of nanoe™ X technology has been tested by 3rd party laboratories in Germany, France, Denmark, Malaysia and Japan.

The nanoe™ X performance varies depending on the room size, environment and usage and it may take several hours to reach the full effect. nanoe™ X is not medical device, local regulations on building design and sanitary recommendations must be followed. Test results conducted under controlled laboratory conditions. Performance of nanoe™ X might differ in real life environment.

	Tested contents		Result	Capacity	Time	Testing organisation	Report No.
Airborne	Virus	Bacteriophage ΦX174	99,7% inhibited	Approx. 25 m³	6 h	Kitasato Research Center for Environmental Science	24_0300_1
	Bacteria	Staphylococcus aureus	99,7% inhibited	Approx. 25 m³	4 h	Kitasato Research Center for Environmental Science	24_0301_1
Adhered	Virus	SARS-CoV-2	91,4% inhibited	6,7 m³	8 h	Texcell (France)	1140-01 C3
		SARS-CoV-2	99,9% inhibited	45 L	2 h	Texcell (France)	1140-01 A1
		Xenotropic murine leukemia virus	99,999% inhibited	45 L	6 h	Charles River Biopharmaceutical Services GmbH	—
		Influenza (H1N1 subtype)	99,9% inhibited	1 m³	2 h	Kitasato Research Center for Environmental Science	21_0084_1
		Bacteriophage ΦX174	99,8% inhibited	25 m³	8 h	Japan Food Research Laboratories	13001265005-01
	Bacteria	Staphylococcus aureus	99,9% inhibited	20 m³	8 h	Danish Technological Institute	868988
	Pollen	Ambrosia pollen	99,4% inhibited	20 m³	8 h	Danish Technological Institute	868988
	Odours	Cigarette smoke odour	Odour intensity reduced by 2,4 levels	Approx. 23 m³	0,2 h	Panasonic Product Analysis Center	4AA33-160615-N04

First nanoe™ device was developed by Panasonic in 2003

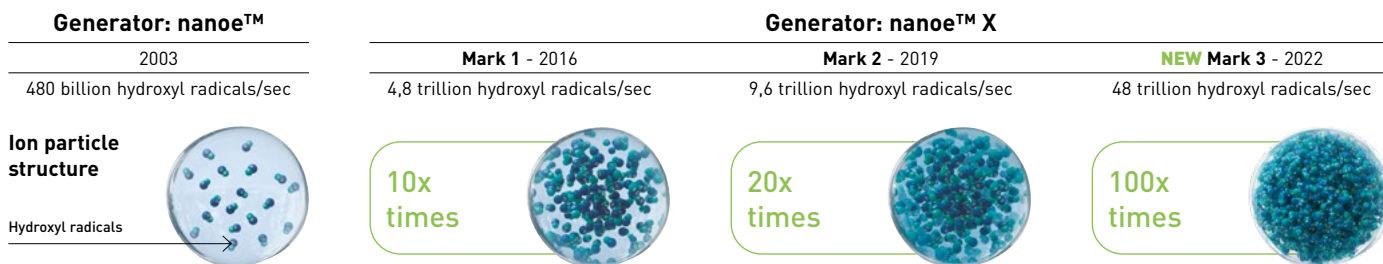

nanoe™ X: improving protection 24/7



Acts to clean your air, so that the indoor environment can be a cleaner and more pleasant place to be all day long. nanoe™ X works together with heating or cooling function when you are at home and can work independently when you are away. Give the air conditioning the strength to increase the protection at home with nanoe™ X technology and convenient control via the Panasonic Comfort Cloud App.



Cleans the air when you are away.

Leave the nanoe™ mode ON to inhibit certain pollutants and deodorise before you return home.

Improves your environment when you are at home.

Enjoy a cleaner, comfortable space with loved ones.

Panasonic Heating & Cooling Solutions is incorporating nanoe™ technology in a wide range of equipment

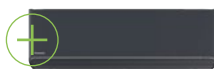

Wall-mounted Etherea. Built-in nanoe X Generator Mark 3.



Floor console. Built-in nanoe X Generator Mark 1.



Wall-mounted TZ super-compact. Built-in nanoe X Generator Mark 1.



Wall-mounted Heatcharge VZ. Built-in nanoe™.

Etherea with nanoe™ X technology

A smart solution to keep your home clean, comfortable and welcoming. The smart, Etherea comes with nanoe™ X technology with the benefits of hydroxyl radicals. With advanced control options, class-leading performance, a stylish design and intelligent features, Etherea is designed to make your home comfortable, clean and the ideal place to be.

—ETHEREA—

Available in 3 colors



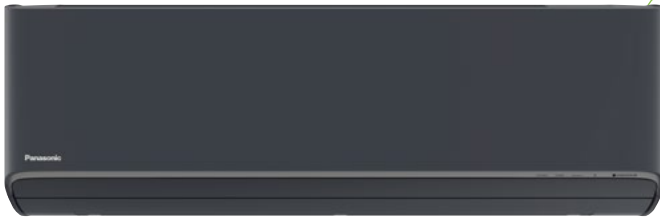

Built-in new
nanoe X Generator Mark 3



BUILT-IN WI-FI

+ SEE PRODUCT SPECIFICATIONS

1 Air quality

- nanoe™ X technology with the benefits of hydroxyl radicals (Generator Mark 3)
- Acts to clean your air, so that the indoor environment can be a cleaner and more pleasant place to be all day long

2 Smart control

- Built-in Wi-Fi for instant connectivity, now with an easier and quicker set-up
- Advanced control via smartphone
- Compatible with Google Assistant and Amazon Alexa



3 High efficiency

- Top class energy efficiency up to A+++ in heating and cooling

4 Ultimate comfort

- Aerowings 2.0, end-to-end vanes enhance comfortable air flow
- Super quiet ambient

5 Design

- Available in graphite grey, silver and matt white color
- Stylish, monolithic design
- Chassis and parts designed for easier installation and servicing
- High class, easy-to-use remote control with backlight

nanoe™ X: Bringing nature's balance indoors

The new Etherea comes with nanoe X Generator Mark 3, the latest of the continuously evolving nanoe™ X technology. It has the largest amount of hydroxyl radical in the history of nanoe™ which generates 48 trillion hydroxyl radical per second, 100 times the hydroxyl radical contained in traditional nanoe™. The increased number of hydroxyl radical, which are the key to nanoe™ power, means you can expect an even higher level of performance.

Comparison of time required to inhibit 99% of cedar pollen ³⁾.

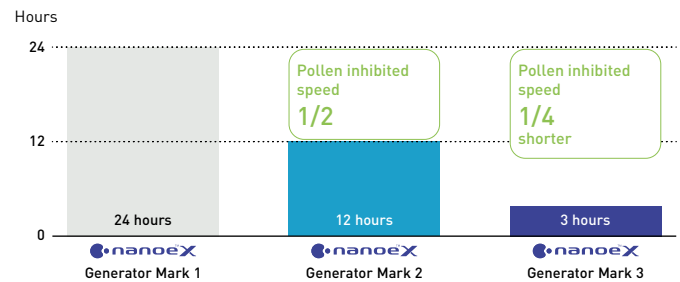

Technology for the ultimate comfort

Introducing the Aerowings 2.0 to the Etherea range.

Panasonic's Aerowings technology consists of two independent flexible vanes that concentrate air flow to heat or cool a room in the shortest time possible and helps distribute air evenly throughout a room.

Thanks to the larger sub vane (72 mm), which is more than doubled in size than other conventional designs, the ability to lift air flow has been further improved.



Aerowings 2.0 has a shower cooling feature which allows air flow to be concentrated evenly towards the ceiling to achieve comfortable cooling across a room, showering gently down into a room rather than one area subject to a continuous icy blast.



For heating, Aerowings 2.0 releases a concentrated air flow downwards to achieve an effect similar to floor heating the air, which rises and fills the room.



Inside cleaning

The inside cleaning operation acts to clean the inside of indoor unit. It uses nanoe™ X technology that can inhibit certain adhered bacteria, viruses, and mould on the filter, evaporator and air outlet and filter up to 99%. New cross flow fan is coated to prevent dust adhered on its surfaces and can be effective against certain bacteria and mould.

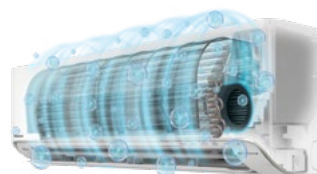

Without coating:
Adhered dust.



With anti-static coating:
Maintain cleanliness

Proven prevents dust adhered 62,5%* compare with non-coating.

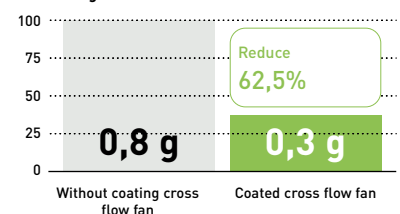

The amount of dust or mould may change depending on the usage frequency and environment.
* Based on Panasonic internal testing result.

Heatcharge. Energy Charge System

heatcharge

Energy class A +++ and offers maximum comfort and energy savings. This powerful air heat pump is designed for commercial and residential climate that places extremely high demands on the heating system.





[+ SEE PRODUCT SPECIFICATIONS](#)

1 Powerful, reliable heating even at low ambient winter temperatures

When the air conditioner is operating, the compressor, which is the power supply of the unit, generates heat. Until now, this heat was released into the atmosphere. Panasonic has utilised this waste heat!

Constant heating.

Using stored heat provides stable heating with less drop in temperature. Even when heating operation stops during defrost operation, stored heat continues to constantly warm the room. This eliminates the previous discomfort due to the temperature dropping when heating temporarily stops to ensure stable air conditioner heating.

2 Panasonic's full line-up of A+++ heat pumps

In response to the Kyoto Protocol, the European Union set some challenging targets for the reduction in greenhouse-gas emissions. By the year 2020, across the member states, the EU wants to have achieved the following objectives:

- A 20% cut in greenhouse gas emissions (from 1990 base levels)
- The share of renewables in the energy mix to increase by 20%
- An overall reduction of 20% in energy consumption

3 Comfort and efficiency

- nanoe™ technology with the benefits of hydroxyl radicals
- Higher efficiency and comfort with Econavi sunlight detection and human activity detection
- Powerful air flow to quickly reach the desired temperature

Conventional. The room gradually becomes cold.

Defrost operation: About 11 to 15 min. Fall in room temperature: About 5 to 6 °C.

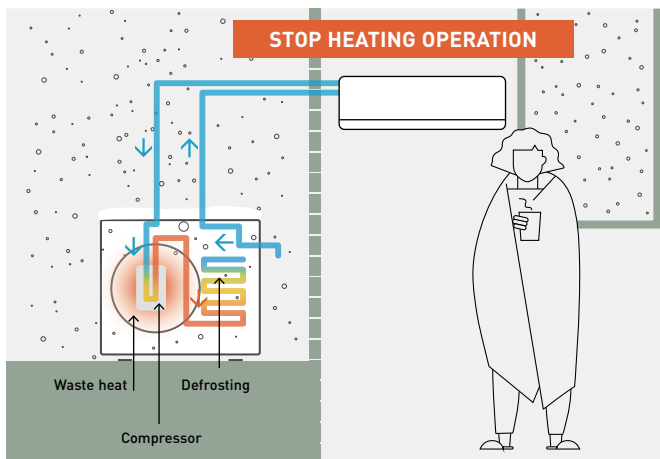

Heatcharge. The room is thoroughly warmed.

Defrost operation: About 5 to 6 min. Fall in room temperature: About 1 to 2 °C.

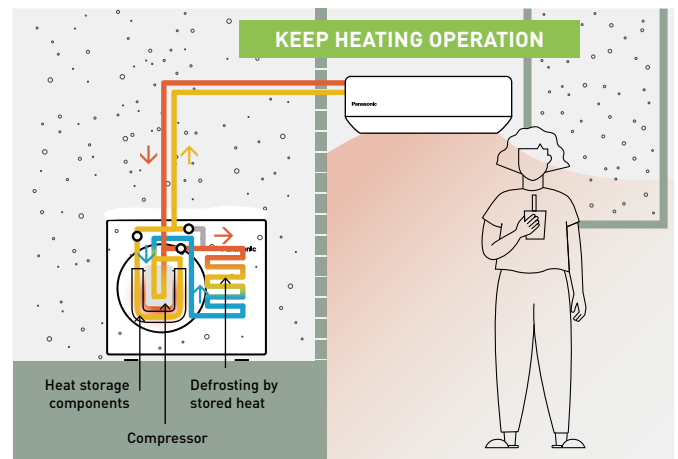

Conventional.

During operation, heat is generated inside the compressor.

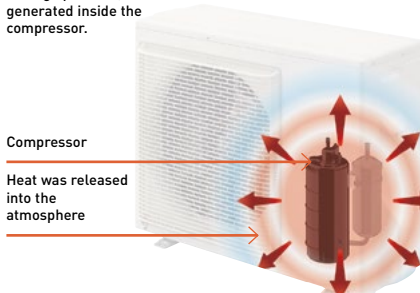

Heatcharge.

Heat generated by the compressor is stored inside and used to warm the refrigerant to efficiently increase heating power.

Waste heat is "charged" and used effectively



Heatcharge.

The compressor is wrapped and exhaust heat is used for charging.

Heatcharge tank. Waste heat from the compressor is stored.

Finless heat exchanger. Stored heat is converted to energy.

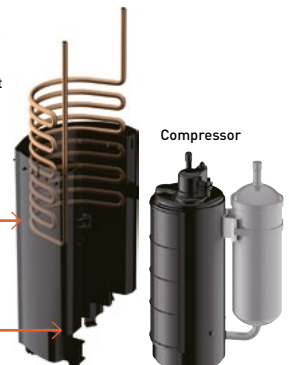

* Defrost operation time and how low room temperature falls differ depending on the environment in which the unit is being used (how insulated and airtight the room is), operation conditions, and temperature conditions. Output air temperature falls during defrost operation. How low room temperature falls differs depending on the environment in which the unit is being used (how insulated and airtight the room is), operation conditions, and temperature conditions. In environments where a lot of frost accumulates, heating may stop during defrost operation.

Wall-mounted TZ super-compact

The perfect air conditioner for the smallest spaces in your home.
TZ with R32 refrigerant powerful and efficient.





[+ SEE PRODUCT SPECIFICATIONS](#)

1 Air quality

- nanoe™ X technology with the benefits of hydroxyl radicals
- Acts to clean your air, so that the indoor environment can be a cleaner and more pleasant place to be all day long

2 Smart control

- Built-in Wi-Fi for instant connectivity, now with an easier and quicker set-up
- Advanced control via smartphone
- Compatible with Google Assistant and Amazon Alexa



3 Ultimate comfort

- Aerowings to control air draft direction
- Super quiet ambient

4 Design

- Super-compact design, just 779 mm wide
- Chassis and parts designed for easier installation and servicing
- High class, easy-to-use remote control with backlight

nanoe™ X: Bringing nature's balance indoors

Panasonic's nanoe™ X technology brings nature's detergent – hydroxyl radicals – indoors to help improve protection 24/7 against several types of pollutants can be inhibited such as certain types of bacteria, viruses, mould, allergens, pollen or hazardous substances.

The nanoe™ X performance varies depending on the room size, environment and usage and it may take several hours to reach the full effect (see page 115 for more detail). nanoe™ X is not medical device, local regulations on building design and sanitary recommendations must be followed.



Super-compact design

The compact design of the indoor units have a width of just 779 mm. This allows for more installation possibilities, including the limited space above a door.

The easy-to-use remote controller features an ergonomic design with tapered rear housing for the most comfortable grip. The controller's intuitive design provides easy operation with five quick access keys for convenient use. The controller also has a minimalist design with the less frequently used keys concealed under a sliding cover.



Aerowings

Panasonic's Aerowings feature incorporates two blades that concentrate air flow to cool you down in the shortest time possible. This also helps distribute cool air evenly throughout the room.

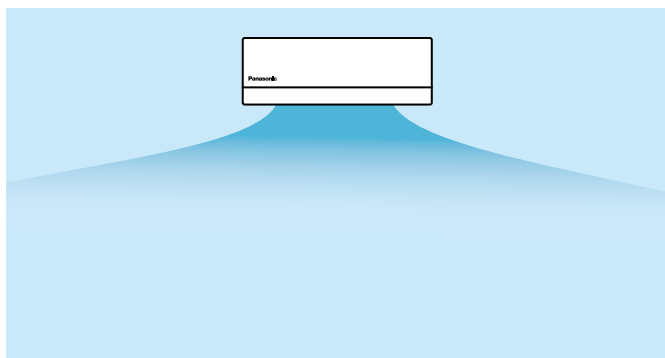

Comfort that goes on and on with Shower Cooling.

When the Aerowings twin blades direct air towards the ceiling they create the Shower Cooling effect. This ensures cool air is evenly distributed throughout the room and you can stay comfortable without experiencing continuous direct cooling.

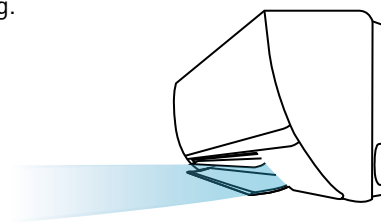

Panasonic Air Conditioners with Aerowings feature an indoor design with wider intake grille and super-high fan speed to produce bigger air flow.

Wall-mounted indoor units, designed for simple installation and maintenance

The full range of wall-mounted indoor units has been carefully designed for simple, stress-free installation and ongoing maintenance.

* Not applicable to VZ.





Feature available in Etherea, TZ, BZ, and UZ

1 Simple installation

Thanks to advanced improvements, installation time has been dramatically decreased. The models have been designed to provide more stability and strength for neat installation, with newly built-in support and convenient access to the drain hose, cabling inserts and larger space for secure installation.

2 Easy maintenance

Meticulously designed for both installer and user benefit, the unit features an easy to remove front grille for convenient access to the interior. The inner workings of the unit have also been redesigned to make maintenance quicker and easier. Electronics and wiring components are now on just one side of the unit to simplify maintenance.



1. Stronger installation plate.

The models feature a stronger, solid installation plate that provides more stability and strength. For uneven surfaces, there are 2 additional screws to ensure a neat and secure installation.

Installation plate: Strong and solid.

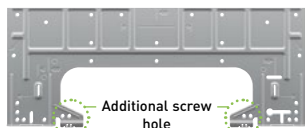

Screw holder for uneven surface (screws not provided).



2. One-piece front grille.

The model comes with a one-piece front grille design to make servicing easier. First, open the intake grille and remove the screws. Next, slide the three slider locks and remove the front grille.

One-piece front grille: Easy removal.



Slider locks: Easy to unlock / lock.

3. Built-in support holder.

The model features a built-in support holder, making installation easier and providing convenience and workspace improvements.

Convenient installation and serviceability.



4. Easy access to drain hose and piping connection.

With larger piping space, pipes and insulations are securely and neatly hidden.

With the visible piping storage, pipes can easily be inspected for leaks without lifting the unit.

Piping storage: up to 15% larger (for TZ-ZKE).

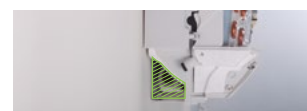

Bigger working space.

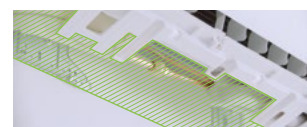

5. Easy wire insertion and tightening.

The models have combined 2 wire inserts into 1, ensuring front visibility and convenience while inserting wires from the back.

Single tunnel: easy wire insert.



Bigger working space for wiring connection.



6. Easy removal of PCB.

PCB removal is achieved in just 4 easy steps. Simply remove the control board cover, disconnect all connectors from the indicator, disconnect all connectors and pull out the main PCB.

Simple steps for PCB removal.

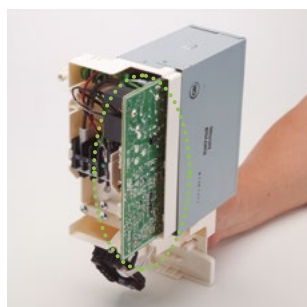

7. Easy / hidden installation of the Wi-Fi adapter.

The latest model features a dedicated space for a network adapter. Easy to plug in, the guided wire slots allow for clear, easy installation and can be neatly tucked away - simple and out of sight!

* Only for models without built-in network adapter.



8. Cross flow fan removal.

The models are carefully designed to make removal of cross flow fans easier compared to the previous models, saving valuable time.

Bigger diameter: up to Ø105 (for Z-ZKE).

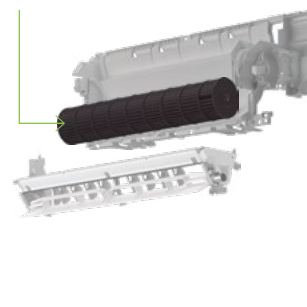

Floor console. Efficient comfort and clean air all year round

Floor console with nanoe™ X technology: outstanding efficiency A++, comfort (Super Quiet technology only 20 dB(A)) and better air quality combined in a breakthrough design.





The iF Product Design Awards are among the most prestigious awards for product design excellence. Winning the award thanks to its highly intelligent functionality, the Panasonic Floor console is the ideal air-conditioning system for domestic and commercial applications.

[+ SEE PRODUCT SPECIFICATIONS](#)

1 nanoe™ X: Bringing nature's balance indoors

Panasonic's nanoe™ X technology brings nature's detergent – hydroxyl radicals – indoors to help improve protection 24/7 against several types of pollutants can be inhibited such as certain types of bacteria, viruses, mould, allergens, pollen or hazardous substances.

The nanoe™ X performance varies depending on the room size, environment and usage and it may take several hours to reach the full effect (see page 115 for more detail). nanoe™ X is not medical device, local regulations on building design and sanitary recommendations must be followed.

2 Super Quiet operation

When the system reaches its set temperature, the unit will operate at only 20 dB(A). Creating a comfortable home is not only by temperature - a quiet atmosphere is also important.

3 Designed to follow the high European demands

Super quiet operation, highly efficient and technology to help clean the air.

Double air flow for improved comfort and temperature dispersion: through the top for an efficient operation

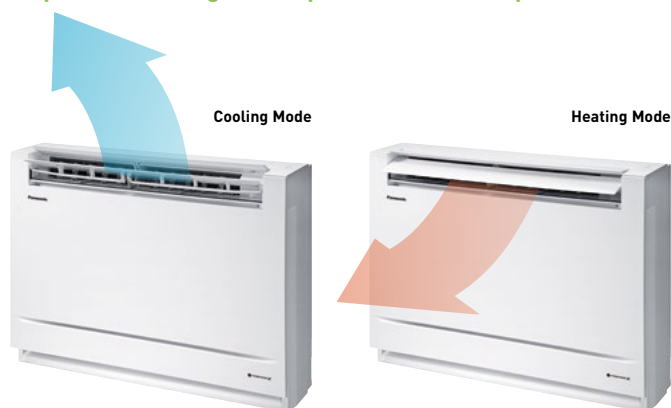

Stylish infrared control

Enjoy innovative design at your fingertips with the stylish and sleek Backlit Sky Controller. Bigger screen and easier to use.



Easy to integrate into your home

A breakthrough design that integrates perfectly with any style. We have carefully selected materials and processes to create an elegant design. Compact in size and with a stylish design, the floor console will easily integrate into your home's interior decoration. There are four options available:



High energy efficiency class A++

The floor console brings the outdoor heat energy inside. Can provide heat inside even when it is -15 °C outside.

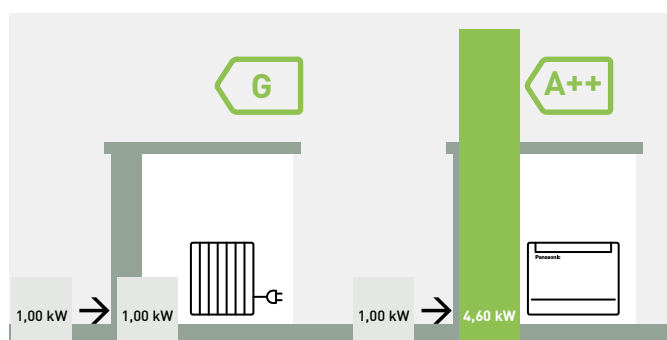

* SCOP on heating mode for Floor console Type KIT-Z25-UFE and KIT-Z35-UFE compared with electrical heaters at +7 °C.

The perfect solution for the replacement of old boiler heating systems



Panasonic R2 rotary compressor

The secret is flexibility. Panasonic Inverter air conditioners have the flexibility to vary the rotation speed of the compressor. This allows it to use less energy to maintain the set temperature while also being able to cool the room quicker at start up.

So you can enjoy better savings on your electricity bills while maintaining cooling comfort.



R2 rotary compressors utilize rolling piston technology. The R2 compressor has been tested in extreme conditions: higher efficiency, single and dual piston, R32 / R410A refrigerant, compact size.

Making the world a cooler place since 1978.

Panasonic rotary compressors for room air conditioners have been installed in the most demanding environments around the world. Designed to withstand extreme conditions, Panasonic Rotary delivers high performance, efficiency and reliable service, no matter where you are. Panasonic, the world's largest manufacturer of rotary compressors.

Why is the Panasonic R2 rotary compressor so efficient?

1. High efficiency motor. The premium silicon steel motor meets industry efficiency requirements.
2. Improved lubrication of high volume oil pump. The extended, high volume oil pump in conjunction with a larger capacity oil reservoir provides superior lubrication.
3. Accumulator has larger refrigerant capacity. The larger accumulator accommodates generous refrigerant amounts needed in longer line length installations.

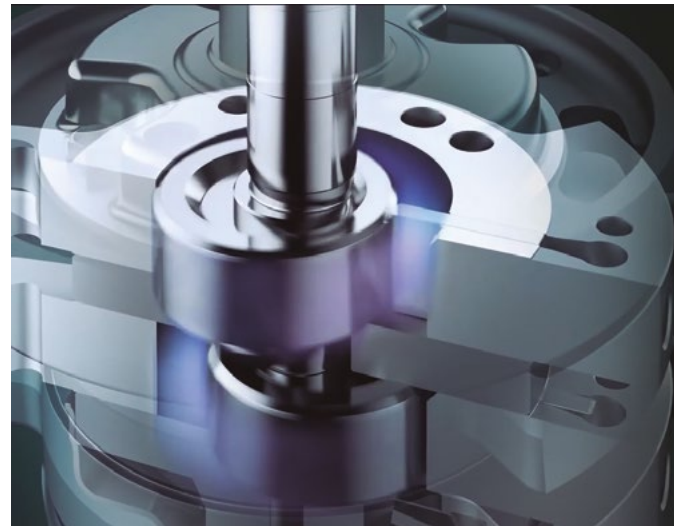

* This image is for 5,0 / 7,1 kW.

R2 compressor value

About R2 compressor.

Built upon 36 years of compressor design and production experience, R2 is the next generation of rotary compressors for residential central air conditioning. The technology improvements, enhanced materials and simple design ensure R2 compressors are reliable, efficient and quiet. The R2 compressor delivers quality, comfort and peace of mind in homes around the world. Panasonic's Rotary Compressors have been life tested in some of the world's most demanding environments and the R2 design is the compressor of choice by contractors and homeowners in these challenging climates. For the high performance that home-owners demand, R2 rotary compressors are considered by the industry experts.

Leading technology.

Used in over 80% of cooling solutions globally, rotary is the world's dominant residential air conditioning compression technology. Panasonic is the leading rotary and residential AC compressor manufacturer in the world, with over 200 million compressors produced.

Benefits.

Central air conditioning delivered with a Panasonic R2 rotary compressor ensures a superior level of comfort at an economical cost.

Inverter technology

Great energy-saving performance. Reduces electricity consumption.

Panasonic Inverter air conditioners are designed to give you exceptional energy savings and performance. At the start up of an air conditioner's operation, a boost in power is required to reach the set temperature. After the set temperature is reached, less power is required to maintain it. The Panasonic Inverter air conditioner varies the rotation speed of the compressor. This provides a highly precise method of maintaining the set temperature.

Constant comfort.

Precise temperature control with a wide power output range enables an Inverter air conditioner to meet different room occupancy levels – thus ensuring constant comfort.

Quick comfort.

Panasonic Inverter air conditioners can operate with higher power during the start up period to cool the room 1,5 times faster and heat the room 4 times faster than non-Inverter models.

Comparison of cooling speed.

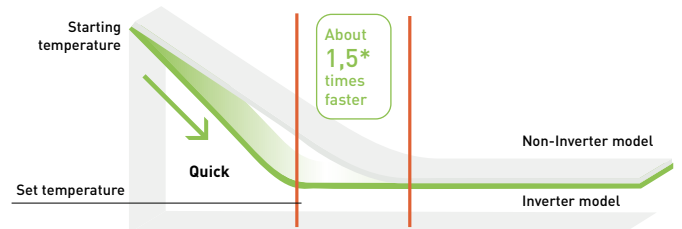

* Comparison of 3,5 kW Inverter vs. non-Inverter. Outside room temperature: 35 °C; setting temperature: 25 °C.

Comparison of heating speed.

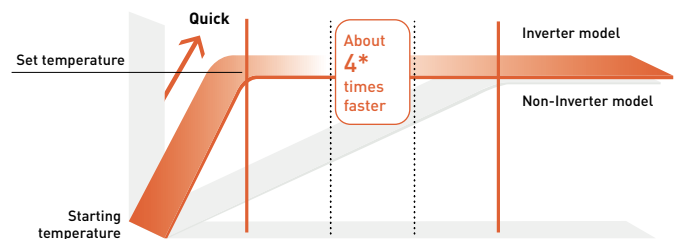

* Comparison of 2,5 kW Inverter vs. non-Inverter. Outside room temperature: 2 °C ; setting temperature: 25 °C.

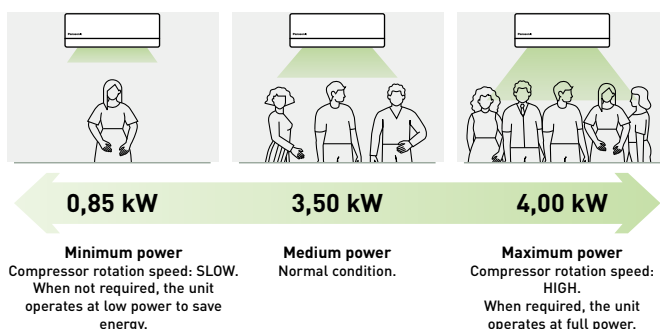

* Graph shows the 3,5 kW Inverter model's wide power output range during cooling.

R22 Renewal. Panasonic standard units can be installed on existing R22 pipings

Change your old air conditioning system to a more efficient system!



An important drive to further reduce the potential damage to our ozone

- All Panasonic standard SKE, TKE and UKE units can be installed on existing R22 pipings
- No need for additional accessories (only pipe reductions)
- Approximately 30% energy savings compared to R22 units

Panasonic is doing its part

We at Panasonic are also doing our part – recognising that all finances are under pressure at the moment. Panasonic has developed a clean and cost effective solution to enable this latest legislation to be introduced with as minimum an effect on businesses and cash reserves as possible.

The Panasonic renewal system allows good quality existing R22 pipe work to be re-used whilst installing new high efficiency R410A / R32 systems.

By bringing a simple solution to the problem Panasonic can renew all Split Systems and PACi systems; and depending upon certain restrictions we don't even limit the manufacturer's equipment we are replacing.

By installing a new high efficiency Panasonic R410A / R32 system you can benefit from around 30% running cost saving compared to the R22 system.

Yes...

1. Check the capacity of the system you wish to replace
2. Select from the Panasonic range the best system to replace it with
3. Follow the procedure detailed in the brochure and technical data

Simple...

R22 - The reduction of Chlorine critical for a cleaner future.

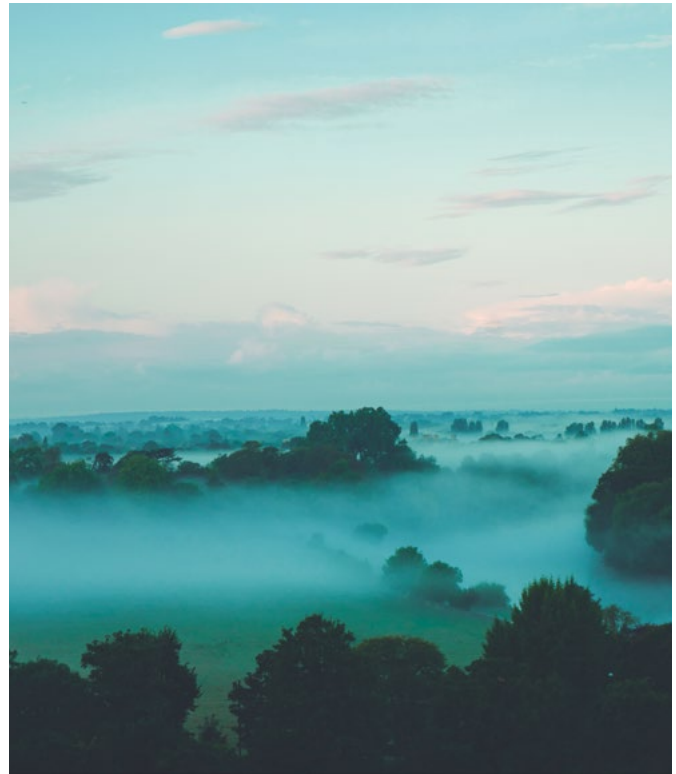

Guidance on re-using existing R22 piping for a new R410A / R32 installation

1. Precaution.

The existing R22 piping can be re-used for a R410A / R32 system installation if the following conditions are met and the piping are finally verified to be:

- Dry (no moisture remaining in the piping)
- Clean (no dust remaining in the piping)
- Tight (no refrigerant leak at the joining and piping)

2. Conditions.

- Recover the refrigerant and oil.
Operate "force cooling" according to the recommended operation time, regardless of the piping length. Single split: 10 min. Multi split: 30 min. After that, carry out "pump down" to recover the refrigerant and oil from the existing R22 system

* Note: If pump down operation is not possible due to the malfunction of the system, flush and wash the existing piping to collect back the oil and dirt inside the system.

- Check the oil condition. If the oil contains dirt, wash the existing pipes
- Check the oil colour. After pump down, use a cotton bud to wipe the oil from the existing pipe. If the oil colour is higher than ASTM3, use a new pipe as re-use of old piping is not allowed
- Check pipe thickness. Make sure that the pipe thickness is more than 0,8 mm. If the thickness is less than 0,8 mm, use a new pipe
- Rework the flare for R410A / R32 connection. Do not reuse the old flare nuts

Deterioration criteria for refrigerant oil.

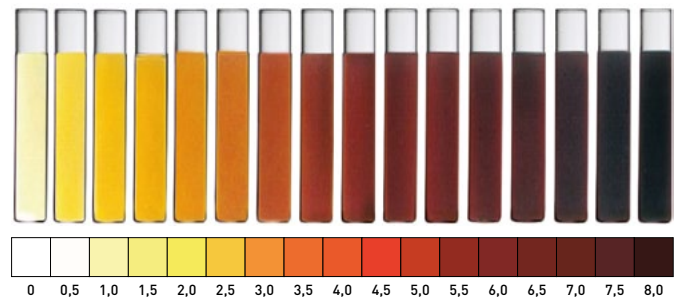

Make sure to use the new flare nuts attached to the R410A / R32 system.

* Note: If the existing piping size is 1/4" (6,35 mm) and 1/2" (12,7 mm), and the new R410A / R32 system is 1/4" (6,35 mm) and 3/8" (9,52 mm), use a pipe reducer connected at indoor and outdoor unit.

3. Applicable model.

Panasonic single split room air conditioner from CS/ CU-RE/UE/YE/XE/CE/NE/E*NKE and PKE series onwards.
Panasonic multi split room air conditioner from CU-2E/3E/4E/5PBE series onwards.

		Liquid		
		Gas	3/8 (9,52)	1/4 (6,35) 1/2 (12,70) 5/8 (15,88)
Split	16 / 20 / 25 / 35	1,6 - 3,5 kW	✓	▲
	42 / 50 / 60	4,2 - 6,0 kW	✗	▲
	71	6,8 - 7,5 kW	✗	✓

✓ Standard piping connection with current piping length and refrigerant charge rules.

▲ This combinations is allowed respecting maximum piping length and refrigerant charged declared in model installed as new.

✗ This combinations is not allowed as it is out of piping diameter.

Welcome to the connected world of Panasonic Comfort Cloud App

Whether you are at home, at the office or running a business, Panasonic Comfort Cloud put total control of your indoor air quality at your fingertips.

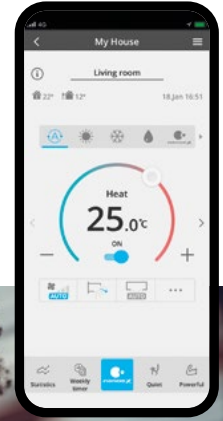
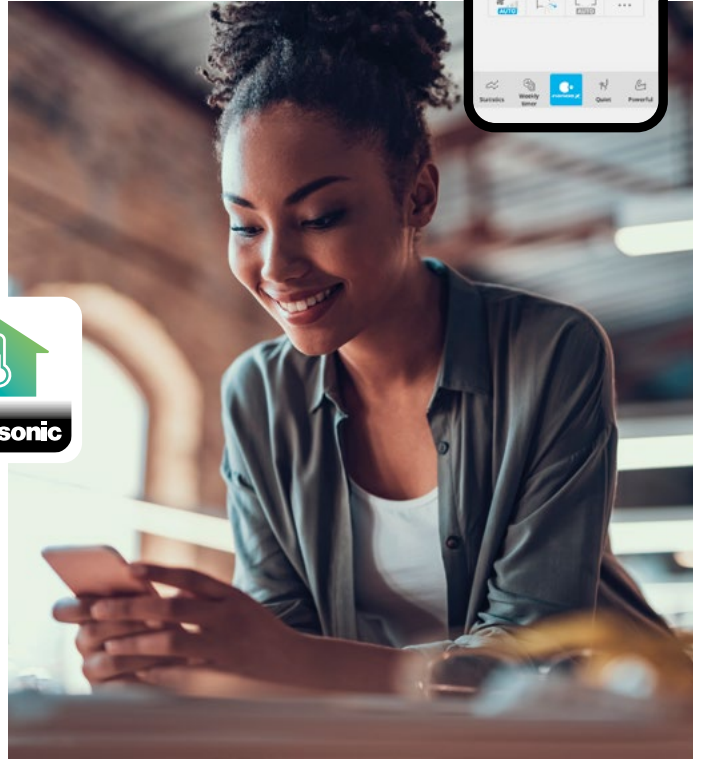

1 Remote control
Control and monitor your air conditioners anytime, anywhere.

2 Monitor energy consumption
Check the energy consumption of each individual unit across different time intervals by comparing the energy usage patterns to maximise energy savings.

3 nanoe™ X: improving protection 24/7*
Switch on nanoe™ X mode with cooling OFF / ON and see the nanoe™ X coverage in your space through a simulation.
* Only for units compatible with nanoe™ X function.

nanoe™ X: improving protection 24/7

Panasonic Comfort Cloud App allows you to see the nanoe™ X coverage in your space through a simulation.



Turn nanoe™ X on easily with “One-touch nanoe™ button” on the main screen.



Select the room shape and size and the unit installation position.

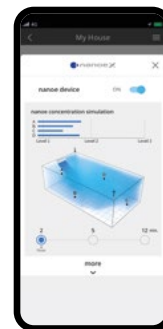
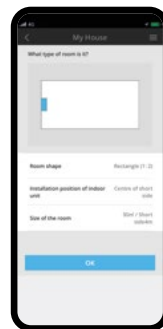

Observe the simulation of nanoe™ X concentration over time!

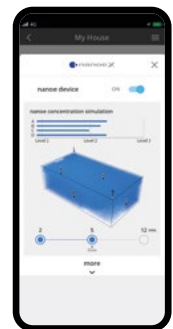

Monitor energy consumption.

Check the energy consumption of each individual unit across different time intervals by comparing the energy usage patterns to maximise energy savings and reduce the operating costs even more.

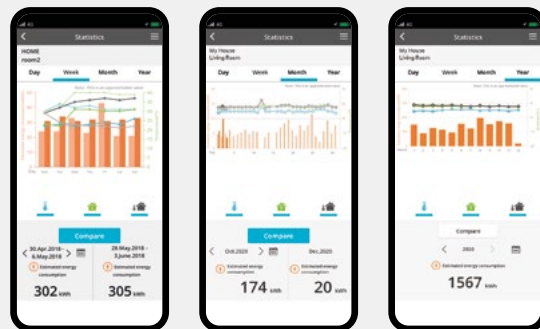

The Panasonic Comfort Cloud Application enables you to conveniently manage and monitor multiple air conditioning units for homes from just one mobile device. Also, energy monitoring is possible allowing opportunity to learn how to reduce the operating cost even more.

- Connectable up to 200 units* with just 1 device
- Compatible for both residential and commercial applications

* 10 different groups, with up to 20 units / per group.



Pre-heat or cool spaces



Weekly timer



Error notifications



Multi-unit control

Easier setup with advanced built-in Wi-Fi

The advanced built-in Wi-Fi setup enables secured and easier connection to Panasonic Comfort Cloud App by scanning the QR code*.

*Feature available only in CS-XZ**ZKEW-H, CS-XZ**ZKEW, CS-MZ16ZKE, CS-Z**ZKEW, CS-MTZ16ZKE and CS-TZ**ZKEW.



Bluetooth™

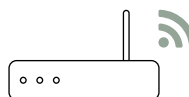

Scan the QR code to enable easier Wi-Fi connectivity to the air conditioner.

Requirements for connecting with Panasonic Comfort Cloud App



Indoor unit with built-in Wi-Fi:
CS-XZ**ZKEW-H, CS-XZ**ZKEW, CS-MZ16ZKE, CS-Z**ZKEW, CS-MTZ16ZKE, CS-TZ**ZKEW and CS-Z**YKEA.

Remark: indoor temperature display and some special functions are not available through the app for all models. Languages: Available in 19 European languages: Bulgarian, Croatian, Czech, Danish, Deutsch, English, Estonian, Finnish, French, Greek, Hungarian, Italian, Norwegian, Polish, Portuguese, Slovenian, Spanish, Swedish, Turkish and Lithuanian.



Indoor unit with optional CZ-TACG1 Wi-Fi adapter:
CS-BZ**ZKE, CZ-UZ**ZKE, CS-MZ20UFEA, CS-Z**UFEAW, CS-MZ20UD3EA and CS-Z**UD3EAW

Indoor unit with optional CZ-CAPWF1 Wi-Fi adapter or CONEX remote controller:
S-M20PY3E and S-**PY3E.

Download free app: Panasonic Comfort Cloud App.

Other hardware requirements: Router and Internet (purchase and subscribe separately). Built-in Wi-Fi in certain models or with optional adaptor CZ-TACG1 connected to port CN-CNT. Panasonic Cloud Server is designed, operated and managed by Panasonic.



Voice Control. Words do more than actions

Control without boundaries and get hands-free help to fully access the features of your air conditioners. Maximising your cooling comfort is now a breeze with our Network-Enabled air conditioners with Panasonic Comfort Cloud App and Voice Control.

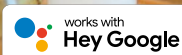

1 Turn ON / OFF air conditioner

Convenient control for blissful rest.

Turn ON / OFF AC with ease when preparing a comfortable space for your little ones.

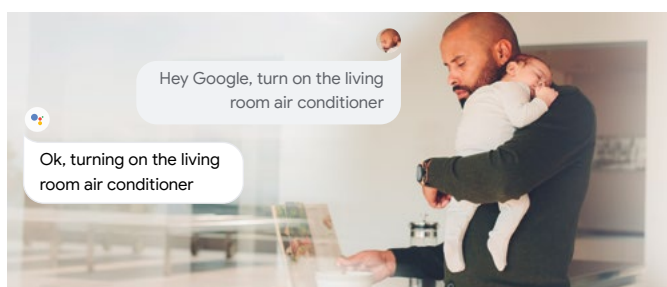

3 Adjust temperature

Easy control for uninterrupted quality time.

Adjust AC temperature to your comfort with a simple voice command.



2 Change mode

Extra help when you have a hectic day.

Conveniently change your AC operation mode to cool / heat / auto when your hands are full.



4 Check current status

Hands-free comfort for the whole family.

Easy access for the elderly to check current AC operation status and adjust AC settings.



Get multiple things done with your voice

Simplify your day with your personalised routine by grouping individual actions.



Schedule your routine with your voice.

With the routine function, you can customise voice commands and control multiple voice-controlled devices including our network-enabled air conditioners to help you with your personalised routine.

Example of morning routine.



Example of night routine.



Find out more (Amazon): <https://www.techhive.com/article/3327501/how-to-use-alexa-routines.html>

Voice Control with Network-Enabled air conditioners

Functions	When you are home		When away from home
	Remote control	Voice Control	Comfort Cloud App
Smart control	Power ON / OFF	✓	✓
	Control multiple units in 1 location	—	✓
	Control multiple units in multiple locations	—	✓
	Set up and manage routines	—	—
Smart comfort	Cooling mode	✓	✓
	Heating mode	✓	✓
	Auto mode	✓	✓
	nanoe™ X mode	✓	—
	Inside cleaning	✓	—
	Summer House mode	✓	—
	Pre-cool	—	—
	Change temperature	✓	✓
Smart efficiency	Analyse energy usage patterns	—	✓
	Compare historical usage	—	✓
	Receive error notifications	—	✓
Smart assist	Assign multiple users	—	✓
	Check power ON / OFF	✓	✓
	Check temperature settings	✓	✓
	Check room temperature	✓	✓

Seamless set up in 3 simple steps

Set up your Panasonic Comfort Cloud App.



Set up your Google Nest Mini or Amazon Echo devices and app.



Link your Google Nest Mini or Amazon Echo with Panasonic Comfort Cloud App.



Compatible devices as of January 2023:
 1. Android™ 7.1 or above
 2. iOS 13.6 or above

Please note:
 · This is not a definitive list of all compatible devices, other similar devices which use supported Operating Systems should also work either via dedicated apps. Please note that user experience may vary slightly depending on hardware and software combination
 · Google, Android, Google Play and Google Home are trademarks of Google LLC.
 · Google Assistant is not available in certain languages and countries
 · Amazon, Alexa and all related logos are trademarks of Amazon.com, Inc. or its affiliates
 · Availability of Voice Assistant services varies depending on country and language
 · Google Assistant and Alexa are compatible with the models shown in pages 136 and 137.



Control and connectivity

Panasonic offers its customers cutting-edge technology, specially designed to ensure our air conditioning systems deliver even higher performance.

You can properly manage the air conditioning and perform comprehensive monitoring and control, with all of the features the remote controller provides at home, from anywhere in the world thanks to the internet applications Panasonic has created for you.



Wi-Fi adapter for smart control via Panasonic Comfort Cloud App

CZ-TACG1. Network adaptor (optional)*.

- Optional RAC network adaptor
- Compact size for easy installation
- Available for built-in or exposed installation depending on model type

* Functionality varies depending on models. Please contact your local dealers for compatible models.

Specifications.

- Input voltage: DC 12 V
- Power consumption: Maximum 660 mW
- Size (H x W x D): 66 x 36 x 12 mm
- Mass: Approx. 85 g
- Interface: 1 x Wireless LAN
- Wireless LAN standard: IEEE 802.11 b/g/n
- Frequency range: 2,4GHz band
- Encryption: WPA2-PSK (TKIP/AES)



Domestic integration to S-Link

CZ-CAPRA1

Can connect RAC range to S-Link. Full control is now possible.

Integrates any unit in big system control.

- YKEA server room integration ¹⁾
- Small offices with domestic indoors
- Tender for refurbishment (old system Domestic and VRF in one installation)
- Centralized Control Systems: 64 indoor units
- Intelligent controller / Web Server: 256 indoor units
- Panasonic AC Smart Cloud

1) When duty rotation using the remote controller is set up, CZ-CAPRA1 cannot be connected.

- Basic operation items: ON / OFF, Mode select, Temperature setting, Fan speed, Flap setting, Remote control prohibit.
- External input: ON / OFF control signal, Abnormal stop signal.
- External output for Relay ¹⁾: Operation status (ON / OFF), Alarm status output.

1) Because current CN-CNT connector can not provide the power for external output relay, additional 12 V DC power supply for external relay is necessary.

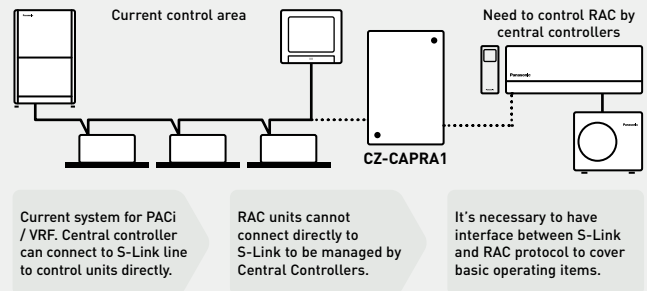

Control by BMS

PAW-AC-KNX-1i (Intesis), PAW-AC-MBS-1 (Intesis), PAW-AC-BAC-1 ¹⁾ (Intesis), PAW-AZAC-KNX-1 (Airzone), PAW-AZAC-MBS-1 (Airzone) and PAW-AZAC-BAC-1 (Airzone).

Great flexibility for integration into your KNX, Modbus and BACnet projects allows fully bi-directional monitoring and control of all the functioning parameters.

- Quick Installation
- External power not required
- Direct connection to the unit via CN-CNT connector
- Bidirectional control
- Unit can be controller simultaneously by remote controller and the gateway

1) This interface allows a complete and natural integration of Panasonic air conditioners into either BACnet IP or MS/TP networks. Is a BTL certified device. * For specific functionality list of each gateway, please check the user's manual.

Easy connectivity



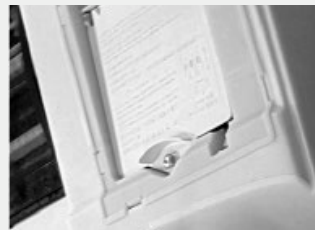





CN-CNT port easy to access in all indoor units, without dismantling the unit to reach the connector. Can easier connect: Wireless accessory / KNX / Modbus / BACnet / CZ-TACG1 / CZ-CAPRA1 to integrate to PACi control.



Model name	Interface
CZ-TACG1	Wi-Fi adapter for smart control via Panasonic Comfort Cloud App
CZ-CAPRA1	RAC interface adapter for integration into S-Link, plus external input and alarm/status output
PAW-AC-KNX-1i	KNX interface. Can be used with all models which have a CN-CNT connector (Intesis)
PAW-AC-MBS-1	Modbus interface. Can be used with all models which have a CN-CNT connector (Intesis)
PAW-AC-BAC-1	BACnet interface. Can be used with all models which have a CN-CNT connector (Intesis)
PAW-AZAC-KNX-1	KNX interface. Can be used with all models which have a CN-CNT connector (Airzone)

Model name	Interface
PAW-AZAC-MBS-1	Modbus interface. Can be used with all models which have a CN-CNT connector (Airzone)
PAW-AZAC-BAC-1	BACnet interface. Can be used with all models which have a CN-CNT connector (Airzone)
PAW-AC-HEAT-1	Heating only PCB for Etherea and low static pressure hide-away
PAW-AC-DIO	This interface can be used with all models which have a CN-RMT connector
PAW-SMSPCONTROL	Control of the Etherea and Heatcharge by SMS (need additional SIM card)

Domestic air conditioner R32 range

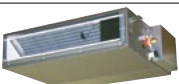

Page	Single split units	2,0 kW	2,5 kW	3,5 kW	4,2 kW	5,0 kW	6,0 kW	7,1 kW
	Wall-mounted Heatcharge VZ · R32							
P. 138			CS-VZ9SKE CU-VZ9SKE	CS-VZ12SKE CU-VZ12SKE				
	NEW Wall-mounted Etherea · R32							
P. 139		CS-XZ20ZKEW-H CU-Z20ZKE	CS-XZ25ZKEW-H CU-Z25ZKE	CS-XZ35ZKEW-H CU-Z35ZKE	CS-XZ42ZKEW-H CU-Z42ZKE			
		CS-XZ20ZKEW CU-Z20ZKE	CS-XZ25ZKEW CU-Z25ZKE	CS-XZ35ZKEW CU-Z35ZKE		CS-XZ50ZKEW CU-Z50ZKE		
		CS-Z20ZKEW CU-Z20ZKE	CS-Z25ZKEW CU-Z25ZKE	CS-Z35ZKEW CU-Z35ZKE	CS-Z42ZKEW CU-Z42ZKE	CS-Z50ZKEW CU-Z50ZKE		CS-Z71ZKEW CU-Z71ZKE
	NEW Wall-mounted TZ super-compact · R32							
P. 140		CS-TZ20ZKEW CU-TZ20ZKE	CS-TZ25ZKEW CU-TZ25ZKE	CS-TZ35ZKEW CU-TZ35ZKE	CS-TZ42ZKEW CU-TZ42ZKE	CS-TZ50ZKEW CU-TZ50ZKE	CS-TZ60ZKEW CU-TZ60ZKE	CS-TZ71ZKEW CU-TZ71ZKE
	NEW Wall-mounted BZ super-compact · R32							
P. 141			CS-BZ25ZKE CU-BZ25ZKE	CS-BZ35ZKE CU-BZ35ZKE		CS-BZ50ZKE CU-BZ50ZKE	CS-BZ60ZKE CU-BZ60ZKE	
	NEW Wall-mounted UZ super-compact · R32							
P. 142			CS-UZ25ZKE CU-UZ25ZKE	CS-UZ35ZKE CU-UZ35ZKE		CS-UZ50ZKE CU-UZ50ZKE		
	Floor console · R32							
P. 143			CS-Z25UFEAW CU-Z25UBEA	CS-Z35UFEAW CU-Z35UBEA		CS-Z50UFEAW CU-Z50UBEA		
	Low static pressure hide-away · R32							
P. 144			CS-Z25UD3EAW CU-Z25UBEA	CS-Z35UD3EAW CU-Z35UBEA		CS-Z50UD3EAW CU-Z50UBEA	CS-Z60UD3EAW CU-Z60UBEA	

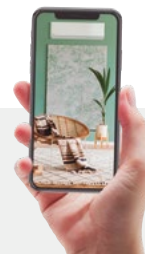
Try the new Panasonic
Augmented Reality projector.



Page	Free Multi indoors	1,6 kW	2,0 kW	2,5 kW	3,5 kW	4,2 kW	5,0 kW	6,0 kW	7,1 kW
------	--------------------	--------	--------	--------	--------	--------	--------	--------	--------

NEW Wall-mounted
Etherea

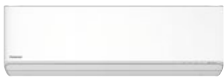
P. 147			CS-XZ20ZKEW-H	CS-XZ25ZKEW-H	CS-XZ35ZKEW-H	CS-XZ42ZKEW-H			
			CS-XZ20ZKEW	CS-XZ25ZKEW	CS-XZ35ZKEW		CS-XZ50ZKEW		
		CS-MZ16ZKE	CS-Z20ZKEW	CS-Z25ZKEW	CS-Z35ZKEW	CS-Z42ZKEW	CS-Z50ZKEW		CS-Z71ZKEW

NEW Wall-mounted TZ
super-compact

P. 147		CS-MTZ16ZKE	CS-TZ20ZKEW	CS-TZ25ZKEW	CS-TZ35ZKEW	CS-TZ42ZKEW	CS-TZ50ZKEW	CS-TZ60ZKEW	CS-TZ71ZKEW
--------	---	-------------	-------------	-------------	-------------	-------------	-------------	-------------	-------------

Floor console

P. 147			CS-MZ20UFEA	CS-Z25UFEAW	CS-Z35UFEAW		CS-Z50UFEAW		
--------	--	--	-------------	-------------	-------------	--	-------------	--	--

4 Way 60x60 cassette

P. 147			S-M20PY3E CZ-KPY4	S-25PY3E CZ-KPY4	S-36PY3E CZ-KPY4		S-50PY3E CZ-KPY4	S-60PY3E CZ-KPY4	
--------	---	--	----------------------	---------------------	---------------------	--	---------------------	---------------------	--



Low static pressure
hide-away

P. 147			CS-MZ20UD3EA	CS-Z25UD3EAW	CS-Z35UD3EAW		CS-Z50UD3EAW	CS-Z60UD3EAW	
--------	---	--	--------------	--------------	--------------	--	--------------	--------------	--

Page	Free Multi outdoors	3,2 ~ 6,0 kW	3,2 ~ 6,0 kW	3,2 ~ 7,7 kW	4,5 ~ 9,5 kW	4,5 ~ 11,2 kW	4,5 ~ 11,5 kW	4,5 ~ 14,7 kW	4,5 ~ 18,3 kW
------	---------------------	--------------	--------------	--------------	--------------	---------------	---------------	---------------	---------------

P. 146	Outdoor units Free Multi system Z - R32								
		CU-2Z35TBE	CU-2Z41TBE	CU-2Z50TBE	CU-3Z52TBE	CU-3Z68TBE	CU-4Z68TBE	CU-4Z80TBE	CU-5Z90TBE

Page	Multi wall TZ outdoors	3,2 ~ 6,0 kW		3,2 ~ 7,7 kW		4,5 ~ 9,5 kW
------	------------------------	--------------	--	--------------	--	--------------

P. 148	Outdoor units Multi TZ for wall TZ indoors - R32					
		CU-2TZ41TBE		CU-2TZ50TBE		CU-3TZ52TBE

Configure in a few steps your multi split system with our online tool.

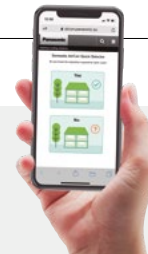

Wall-mounted Heatcharge VZ · R32

- Energy Charge System. Heat storage unit which utilizes non-stop heating and fast heating function
- Econavi Sunlight Detection sensor: Even higher efficiency and great comfort
- nanoe™ technology to improve protection 24/7
- Super Quiet! Only 18 dB(A), equivalent to night-time in the countryside
- Performance tested at -35 °C outdoor temperature



Kit			KIT-VZ9-SKE	KIT-VZ12-SKE
Cooling capacity	Nominal (Min - Max)	kW	2,50 [0,60 - 3,00]	3,50 [0,60 - 4,00]
SEER¹⁾			10,50 A+++	10,00 A+++
Pdesign (cooling)		kW	2,50	3,50
Input power	Nominal (Min - Max)	kW	0,43 [0,14 - 0,61]	0,80 [0,14 - 0,98]
Annual energy consumption ³⁾		kWh/a	83	122
Heating capacity	Nominal (Min - Max)	kW	3,60 [0,60 - 7,80]	4,20 [0,60 - 9,20]
COP ²⁾		W/W	5,63	5,04
Heating capacity at -7 °C		kW	5,00	5,60
COP at -7 °C ²⁾		W/W	2,07	2,00
SCOP¹⁾			6,20 A+++	5,90 A+++
Pdesign at -10 °C		kW	3,60	4,20
Input power	Nominal (Min - Max)	kW	0,64 [0,14 - 2,72]	0,83 [0,14 - 3,16]
Annual energy consumption ³⁾		kWh/a	812	995
Indoor unit			CS-VZ9SKE	CS-VZ12SKE
Power supply		V	230	230
Recommended fuse		A	16	16
Connection indoor / outdoor		mm ²	4 x 1,5	4 x 1,5
Air flow	Cool / Heat (Hi)	m ³ /min	12,5 / 15,5	12,9 / 15,9
Sound pressure ⁴⁾	Cool (Hi / Lo / Q-Lo)	dB(A)	44 / 27 / 18	45 / 33 / 18
	Heat (Hi / Lo / Q-Lo)	dB(A)	44 / 26 / 18	45 / 29 / 18
Dimension	H x W x D	mm	295 x 798 x 375	295 x 798 x 375
Net weight		kg	14,5	14,5
Outdoor unit			CU-VZ9SKE	CU-VZ12SKE
Air flow	Cool / Heat (Hi)	m ³ /min	33,1 / 33,1	35,4 / 33,9
Sound pressure ⁴⁾	Cool / Heat (Hi)	dB(A)	49 / 49	50 / 50
Dimension ⁵⁾	H x W x D	mm	630 x 799 x 299	630 x 799 x 299
Net weight		kg	39,5	39,5
Piping diameter	Liquid	Inch (mm)	1/4 [6,35]	1/4 [6,35]
	Gas	Inch (mm)	3/8 [9,52]	3/8 [9,52]
Pipe length range		m	3 - 15	3 - 15
Elevation difference (in / out)		m	12	12
Pre-charged pipe length		m	7,5	7,5
Additional gas amount		g/m	20	20
Refrigerant (R32) / CO ₂ Eq.		kg / T	1,05 / 0,70875	1,10 / 0,7425
Operating range	Cool Min ~ Max	°C	-10 ~ +43	-10 ~ +43
	Heat Min ~ Max	°C	-30 ~ +24	-30 ~ +24
Lowest outdoor temperature tested by 3rd party laboratory ⁶⁾		°C	-35	-35

1) Energy Label Scale from A+++ to D. 2) EER and COP calculation is based in accordance to EN14511. 3) The annual energy consumption is calculated in accordance to EU/626/2011. 4) The sound pressure of the indoor unit shows the value measured of a position of 1 m in front of the main body and 0,8 m below the unit. For outdoor unit 1 m in front and 1 m in rear side of main body. The sound pressure is measured in accordance with JIS C 9612. Q-Lo: Quiet mode. Lo: The lowest set fan speed. 5) Add 70 mm for piping port. 6) Tested by 3rd party laboratory, SP, according to EN14511:2013 and SP Method 1721, this temperature is not guaranteed by Factory.

Accessories	
CZ-TACG1	Wi-Fi adapter for smart control via Panasonic Comfort Cloud App

Accessories	
CZ-CAPRA1	RAC interface adapter for integration into S-Link
PAW-SMSCONTROL	Control by SMS (need additional SIM card)



SEER and SCOP: For KIT-VZ9-SKE. -35 °C HEATING MODE: Heating performance tested at -35 °C by SP, European third party laboratory. INTERNET CONTROL: Optional.

NEW Wall-mounted Etherea - R32

- nanoe™ X technology to improve protection 24/7
- Sleek and stylish design, in graphite grey, silver and matt white color
- Improved SEER / SCOP to achieve top class energy efficiency
- Aerowings 2.0 for the ultimate comfort
- Easy-to-use remote controller
- Built-in Wi-Fi for instant connectivity via Panasonic Comfort Cloud App
- Compatible with Google Assistant and Amazon Alexa
- Chassis and parts designed for easier installation



Kit graphite grey			KIT-XZ20-ZKE-H	KIT-XZ25-ZKE-H	KIT-XZ35-ZKE-H	KIT-XZ42-ZKE-H	—	—
Kit silver			KIT-XZ20-ZKE	KIT-XZ25-ZKE	KIT-XZ35-ZKE	—	KIT-XZ50-ZKE	—
Kit matt white			KIT-Z20-ZKE	KIT-Z25-ZKE	KIT-Z35-ZKE	KIT-Z42-ZKE	KIT-Z50-ZKE	KIT-Z71-ZKE
Cooling capacity	Nominal (Min - Max)	kW	2,05 (0,75 - 2,65)	2,50 (0,85 - 3,50)	3,50 (0,85 - 4,20)	4,20 (0,85 - 5,00)	5,00 (0,98 - 6,00)	7,10 (0,98 - 8,50)
EER ¹⁾	Nominal (Min - Max)	W/W	4,66 (4,69 - 4,02)	4,90 (5,00 - 3,89)	4,27 (4,25 - 3,62)	3,39 (3,62 - 3,18)	3,68 (3,92 - 3,16)	3,24 (2,33 - 2,83)
SEER ²⁾			8,70 A+++	9,50 A+++	9,50 A+++	7,10 A++	8,50 A+++	6,50 A++
Pdesign (cooling)		kW	2,1	2,5	3,5	4,2	5,0	7,1
Input power	Nominal (Min - Max)	kW	0,44 (0,16 - 0,66)	0,51 (0,17 - 0,90)	0,82 (0,20 - 1,16)	1,24 (0,24 - 1,57)	1,36 (0,25 - 1,90)	2,19 (0,42 - 3,00)
Annual energy consumption ³⁾		kWh/a	84	92	129	207	206	382
Heating capacity	Nominal (Min - Max)	kW	2,80 (0,75 - 4,00)	3,40 (0,80 - 4,80)	4,00 (0,80 - 5,50)	5,30 (0,80 - 6,80)	5,80 (0,98 - 8,00)	8,20 (0,98 - 10,20)
Heating capacity at -7 °C		kW	2,38	2,8	3,2	4,11	4,8	6,31
COP ¹⁾	Nominal (Min - Max)	W/W	4,67 (4,69 - 4,26)	4,86 (5,00 - 4,07)	4,55 (4,44 - 3,77)	3,73 (4,21 - 3,66)	4,14 (4,26 - 3,35)	3,73 (2,45 - 3,31)
SCOP ²⁾			4,80 A++	5,20 A+++	5,20 A+++	4,30 A+	4,80 A++	4,20 A+
Pdesign at -10 °C		kW	2,4	2,6	2,9	3,6	4,2	5,5
Input power	Nominal (Min - Max)	kW	0,60 (0,16 - 0,94)	0,70 (0,16 - 1,18)	0,88 (0,18 - 1,46)	1,42 (0,19 - 1,86)	1,40 (0,23 - 2,39)	2,20 (0,40 - 3,08)
Annual energy consumption ³⁾		kWh/a	700	700	781	1172	1225	1833
Indoor unit graphite grey			CS-XZ20ZKEW-H	CS-XZ25ZKEW-H	CS-XZ35ZKEW-H	CS-Z42ZKEW-H	—	—
Indoor unit silver			CS-XZ20ZKEW	CS-XZ25ZKEW	CS-XZ35ZKEW	—	CS-XZ50ZKEW	—
Indoor unit matt white			CS-Z20ZKEW	CS-Z25ZKEW	CS-Z35ZKEW	CS-Z42ZKEW	CS-Z50ZKEW	CS-Z71ZKEW
Power supply		V	230	230	230	230	230	230
Recommended fuse		A	16	16	16	16	16	20
Connection indoor / outdoor		mm ²	4 x 1,5	4 x 1,5	4 x 1,5	4 x 1,5	4 x 2,5	4 x 2,5
Air flow	Cool / Heat	m ³ /min	10,4/11,9	12,4/13,0	12,7/14,4	14,5/15,4	17,4/19,1	19,0/19,9
Moisture removal volume		L/h	1,3	1,5	2	2,4	2,8	4,1
Sound pressure ⁴⁾	Cool (Hi / Lo / Q-Lo)	dB(A)	35/24/19	39/25/19	42/28/19	43/31/25	44/37/30	47/38/30
	Heat (Hi / Lo / Q-Lo)	dB(A)	36/25/19	39/27/19	43/33/19	43/35/29	44/37/30	47/38/30
Dimension	H x W x D	mm	295 x 870 x 229	295 x 870 x 229	295 x 870 x 229	295 x 870 x 229	295 x 1040 x 244	295 x 1040 x 244
Net weight		kg	10	10	11	10	12	13
nanoe X Generator			Mark 3	Mark 3	Mark 3	Mark 3	Mark 3	Mark 3
Outdoor unit			CU-Z20ZKE	CU-Z25ZKE	CU-Z35ZKE	CU-Z42ZKE	CU-Z50ZKE	CU-Z71ZKE
Air flow	Cool / Heat	m ³ /min	26,5/25,7	28,7/26,5	29,8/29,8	29,8/30,9	39,8/36,9	44,7/45,8
Sound pressure ⁴⁾	Cool / Heat (Hi)	dB(A)	45/46	46/47	48/50	49/51	47/47	52/54
Dimension ⁵⁾	H x W x D	mm	542 x 780 x 289	542 x 780 x 289	542 x 780 x 289	542 x 780 x 289	695 x 875 x 320	695 x 875 x 320
Net weight		kg	27	27	31	31	40	45
Piping diameter	Liquid	Inch (mm)	1/4 (6,35)	1/4 (6,35)	1/4 (6,35)	1/4 (6,35)	1/4 (6,35)	1/4 (6,35)
	Gas	Inch (mm)	3/8 (9,52)	3/8 (9,52)	3/8 (9,52)	1/2 (12,70)	1/2 (12,70)	5/8 (15,88)
Pipe length range		m	3 - 15	3 - 15	3 - 15	3 - 15	3 - 30	3 - 30
Elevation difference (in / out)		m	15	15	15	15	15	20
Pre-charged pipe length		m	7,5	7,5	7,5	7,5	7,5	10
Additional gas amount		g/m	10	10	10	10	15	25
Refrigerant (R32) / CO ₂ Eq.		kg / T	0,70/0,47	0,70/0,47	0,81/0,55	0,83/0,56	1,13/0,76	1,35/0,91
Operating range	Cool Min ~ Max	°C	-10 ~ +43	-10 ~ +43	-10 ~ +43	-10 ~ +43	-10 ~ +43	-10 ~ +43
	Heat Min ~ Max	°C	-20 ~ +24	-20 ~ +24	-20 ~ +24	-20 ~ +24	-20 ~ +24	-20 ~ +24

1) EER and COP calculation is based in accordance to EN14511. 2) Energy Label Scale from A+++ to D. 3) The annual energy consumption is calculated in accordance to EU/626/2011. 4) The sound pressure of the indoor unit shows the value measured at a position of 1 m in front of the main body and 0,8 m below the unit. For outdoor unit 1 m in front and 1 m in rear side of main body. The sound pressure is measured in accordance with JIS C 9612. Q-Lo: Quiet mode. Lo: The lowest set fan speed. 5) Add 70 mm for piping port.

Accessories	
CZ-CAPRA1	RAC interface adapter for integration into S-Link
PAW-SMSCONTROL	Control by SMS (need additional SIM card)

Accessories	
CZ-RD517C	Wired remote controller for wall-mounted and floor console



SEER and SCOP: For KIT-**25-ZKE and KIT-**35-ZKE. SUPER QUIET: For KIT-**20-ZKE, KIT-**25-ZKE and KIT-**35-ZKE. INTERNET CONTROL: Built-in Wi-Fi.

NEW Wall-mounted TZ super-compact - R32

- nanoe™ X technology to improve protection 24/7
- Compact and elegant design with only 779 mm wide
- Built-in Wi-Fi for instant connectivity via Panasonic Comfort Cloud App
- Compatible with Google Assistant and Amazon Alexa
- Easy-to-use remote controller
- Aerowings to control air draft direction

New
2023

Kit			KIT-TZ20-ZKE	KIT-TZ25-ZKE	KIT-TZ35-ZKE	KIT-TZ42-ZKE	KIT-TZ50-ZKE	KIT-TZ60-ZKE	KIT-TZ71-ZKE
Cooling capacity	Nominal (Min - Max)	kW	2,00(0,75-2,50)	2,50(0,85-3,00)	3,50(0,85-4,00)	4,20(0,85-4,60)	5,00(0,98-5,60)	6,00(0,98-6,60)	7,10(0,98-8,40)
EER ¹⁾	Nominal (Min - Max)	W/W	4,08(4,17-3,91)	3,85(4,05-3,41)	3,57(3,62-3,33)	3,36(3,62-2,80)	3,13(3,92-2,96)	3,24(3,92-2,87)	3,23(2,33-2,80)
SEER ²⁾			7,00 A++	7,10 A++	6,80 A++	6,40 A++	6,90 A++	6,80 A++	6,20 A++
Pdesign (cooling)		kW	2,0	2,5	3,5	4,2	5,0	6,0	7,1
Input power	Nominal (Min - Max)	kW	0,49(0,18-0,64)	0,65(0,21-0,88)	0,98(0,24-1,20)	1,25(0,24-1,64)	1,60(0,25-1,89)	1,85(0,25-2,30)	2,20(0,42-3,00)
Annual energy consumption ³⁾		kWh/a	100	123	180	230	254	309	401
Heating capacity	Nominal (Min - Max)	kW	2,70(0,70-3,60)	3,30(0,80-4,10)	4,00(0,80-5,10)	5,00(0,80-6,80)	5,80(0,98-7,50)	7,00(0,98-8,20)	8,20(0,98-10,20)
Heating capacity at -7 °C		kW	2,14	2,70	3,30	3,90	4,62	4,90	6,31
COP ¹⁾	Nominal (Min - Max)	W/W	4,15(4,24-3,53)	4,18(4,21-3,66)	4,04(4,10-3,70)	3,73(4,10-3,33)	3,41(4,67-3,26)	3,72(4,67-3,57)	3,71(2,45-3,29)
SCOP ²⁾			4,60 A++	4,60 A++	4,60 A++	4,10 A+	4,50 A+	4,30 A+	4,10 A+
Pdesign at -10 °C		kW	2,1	2,4	2,8	3,6	4,0	4,4	5,5
Input power	Nominal (Min - Max)	kW	0,65(0,17-1,02)	0,79(0,19-1,12)	0,99(0,20-1,38)	1,34(0,20-2,04)	1,70(0,21-2,30)	1,88(0,21-2,30)	2,21(0,40-3,10)
Annual energy consumption ³⁾		kWh/a	639	730	852	1229	1244	1433	1878
Indoor unit			CS-TZ20ZKEW	CS-TZ25ZKEW	CS-TZ35ZKEW	CS-TZ42ZKEW	CS-TZ50ZKEW	CS-TZ60ZKEW	CS-TZ71ZKEW
Power supply		V	230	230	230	230	230	230	230
Recommended fuse		A	16	16	16	16	16	20	20
Connection indoor / outdoor		mm ²	4 x 1,5	4 x 1,5	4 x 1,5	4 x 1,5	4 x 2,5	4 x 2,5	4 x 2,5
Air flow	Cool / Heat	m ³ /min	9,9/10,4	11,0/11,5	11,8/12,3	12,5/13,2	12,5/13,2	18,4/19,4	19,0/19,9
Moisture removal volume		L/h	1,3	1,5	2	2,4	2,8	3,3	4,1
Sound pressure ⁴⁾	Cool (Hi / Lo / Q-Lo)	dB(A)	37/25/20	40/26/20	42/30/20	44/31/25	44/37/33	45/37/34	47/38/35
	Heat (Hi / Lo / Q-Lo)	dB(A)	38/26/22	40/27/22	42/33/22	44/35/28	44/37/33	45/37/34	47/38/35
Dimension	H x W x D	mm	290 x 779 x 209	290 x 779 x 209	290 x 779 x 209	290 x 779 x 209	290 x 779 x 209	295 x 1040 x 244	295 x 1040 x 244
Net weight		kg	8	8	8	8	8	12	13
nanoe X Generator			Mark 1	Mark 1	Mark 1	Mark 1	Mark 1	Mark 1	Mark 1
Outdoor unit			CU-TZ20ZKE	CU-TZ25ZKE	CU-TZ35ZKE	CU-TZ42ZKE	CU-TZ50ZKE	CU-TZ60ZKE	CU-TZ71ZKE
Air flow	Cool / Heat	m ³ /min	29,7/29,7	30,0/28,9	28,7/29,7	31,0/31,3	32,7/32,7	34,4/35,6	44,7/45,8
Sound pressure ⁴⁾	Cool / Heat (Hi)	dB(A)	46/47	47/48	48/50	49/51	48/49	49/51	52/54
Dimension ⁵⁾	H x W x D	mm	542 x 780 x 289	542 x 780 x 289	542 x 780 x 289	542 x 780 x 289	619 x 824 x 299	619 x 824 x 299	695 x 875 x 320
Net weight		kg	24	25	29	31	35	35	45
Piping diameter	Liquid	Inch (mm)	1/4(6,35)	1/4(6,35)	1/4(6,35)	1/4(6,35)	1/4(6,35)	1/4(6,35)	1/4(6,35)
	Gas	Inch (mm)	3/8(9,52)	3/8(9,52)	3/8(9,52)	1/2(12,70)	1/2(12,70)	1/2(12,70)	5/8(15,88)
Pipe length range		m	3~15	3~15	3~15	3~15	3~20	3~30	3~30
Elevation difference (in / out)		m	15	15	15	15	15	15	20
Pre-charged pipe length		m	7,5	7,5	7,5	7,5	10	10	10
Additional gas amount		g/m	10	10	10	10	15	15	25
Refrigerant (R32) / CO ₂ Eq.		kg / T	0,52/0,35	0,61/0,41	0,67/0,45	0,79/0,53	1,07/0,72	1,22/0,82	1,35/0,91
Operating range	Cool Min - Max	°C	-10~+43	-10~+43	-10~+43	-10~+43	-10~+43	-10~+43	-10~+43
	Heat Min - Max	°C	-15~+24	-15~+24	-15~+24	-15~+24	-15~+24	-15~+24	-15~+24

1) EER and COP calculation is based in accordance to EN14511. 2) Energy Label Scale from A+++ to D. 3) The annual energy consumption is calculated in accordance to EU/626/2011. 4) The sound pressure of the indoor unit shows the value measured of a position of 1 m in front of the main body and 0,8 m below the unit. For outdoor unit 1 m in front and 1 m in rear side of main body. The sound pressure is measured in accordance with JIS C 9612. Q-Lo: Quiet mode. Lo: The lowest set fan speed. 5) Add 70 mm for piping port.

Accessories

CZ-CAPRA1 RAC interface adapter for integration into S-Link

Accessories

CZ-RD517C Wired remote controller for wall-mounted and floor console



SEER and SCOP: For KIT-TZ25-ZKE. SUPER QUIET: For KIT-TZ20-ZKE, KIT-TZ25-ZKE and KIT-TZ35-ZKE. INTERNET CONTROL: Built-in Wi-Fi.

NEW Wall-mounted BZ super-compact · R32

- Compact design with only 779 mm wide
- Cleaner air with PM2,5 Filter
- Super Quiet! Only 20 dB(A)
- Aerowings to control air draft direction
- High energy savings
- Cooling even at -10 °C
- Optional internet and voice control

New
2023



Kit			KIT-BZ25-ZKE	KIT-BZ35-ZKE	KIT-BZ50-ZKE	KIT-BZ60-ZKE
Cooling capacity	Nominal (Min - Max)	kW	2,50 [0,85 - 3,00]	3,30 [0,85 - 3,90]	5,00 [0,98 - 5,40]	6,00 [0,98 - 6,50]
EER ¹⁾	Nominal (Min - Max)	W/W	3,68 [4,05 - 3,33]	3,24 [3,54 - 3,05]	3,03 [3,92 - 2,90]	3,03 [3,92 - 2,83]
SEER ²⁾			6,30 A++	6,30 A++	6,50 A++	6,40 A++
Pdesign (cooling)		kW	2,5	3,3	5	6
Input power	Nominal (Min - Max)	kW	0,68 [0,21 - 0,90]	1,02 [0,24 - 1,28]	1,65 [0,25 - 1,86]	1,98 [0,25 - 2,30]
Annual energy consumption ³⁾		kWh/a	139	183	269	328
Heating capacity	Nominal (Min - Max)	kW	3,15 [0,80 - 3,60]	3,70 [0,80 - 4,40]	5,40 [0,98 - 7,50]	6,80 [0,98 - 8,00]
Heating capacity at -7 °C		kW	2,14	2,60	4,62	5,1
COP ¹⁾	Nominal (Min - Max)	W/W	4,09 [4,21 - 3,50]	3,72 [4,10 - 3,49]	3,42 [4,67 - 3,09]	3,16 [4,26 - 3,02]
SCOP ²⁾			4,30 A+	4,20 A+	4,20 A+	4,10 A+
Pdesign at -10 °C		kW	1,9	2,4	4	4,4
Input power	Nominal (Min - Max)	kW	0,77 [0,19 - 1,03]	1,00 [0,20 - 1,26]	1,58 [0,21 - 2,43]	2,15 [0,23 - 2,65]
Annual energy consumption ³⁾		kWh/a	619	800	1333	1502
Indoor unit			CS-BZ25ZKE	CS-BZ35ZKE	CS-BZ50ZKE	CS-BZ60ZKE
Power supply		V	230	230	230	230
Recommended fuse		A	16	16	16	20
Connection indoor / outdoor		mm ²	4 x 1,5	4 x 1,5	4 x 2,5	4 x 2,5
Air flow	Cool / Heat	m ³ /min	10,5 / 9,5	10,8 / 11,3	12,5 / 13,2	12,7 / 13,6
Moisture removal volume		L/h	1,5	1,9	2,8	3,3
Sound pressure ⁴⁾	Cool (Hi / Lo / Q-Lo)	dB(A)	37 / 26 / 20	38 / 30 / 20	44 / 37 / 34	45 / 37 / 34
	Heat (Hi / Lo / Q-Lo)	dB(A)	36 / 27 / 24	38 / 33 / 25	44 / 37 / 34	45 / 37 / 34
Dimension	H x W x D	mm	290 x 779 x 209	290 x 779 x 209	290 x 779 x 209	290 x 779 x 209
Net weight		kg	8	8	8	9
Outdoor unit			CU-BZ25ZKE	CU-BZ35ZKE	CU-BZ50ZKE	CU-BZ60ZKE
Air flow	Cool / Heat	m ³ /min	30,4 / 30,4	31,1 / 30,4	32,7 / 32,7	42,6 / 39,2
Sound pressure ⁴⁾	Cool / Heat (Hi)	dB(A)	48 / 49	48 / 50	48 / 49	50 / 50
Dimension ⁵⁾	H x W x D	mm	542 x 780 x 289	542 x 780 x 289	619 x 824 x 299	695 x 875 x 320
Net weight		kg	24	25	35	40
Piping diameter	Liquid	Inch (mm)	1/4 (6,35)	1/4 (6,35)	1/4 (6,35)	1/4 (6,35)
	Gas	Inch (mm)	3/8 (9,52)	3/8 (9,52)	1/2 (12,70)	1/2 (12,70)
Pipe length range		m	3 ~ 15	3 ~ 15	3 ~ 15	3 ~ 30
Elevation difference (in / out)		m	15	15	15	15
Pre-charged pipe length		m	7,5	7,5	10	7,5
Additional gas amount		g/m	10	10	15	15
Refrigerant (R32) / CO ₂ Eq.		kg / T	0,52 / 0,35	0,61 / 0,41	1,07 / 0,72	1,11 / 0,75
Operating range	Cool Min ~ Max	°C	-10 ~ +43	-10 ~ +43	-10 ~ +43	-10 ~ +43
	Heat Min ~ Max	°C	-15 ~ +24	-15 ~ +24	-15 ~ +24	-15 ~ +24

1) EER and COP calculation is based in accordance to EN14511. 2) Energy Label Scale from A+++ to D. 3) The annual energy consumption is calculated in accordance to EU/626/2011. 4) The sound pressure of the indoor unit shows the value measured at a position of 1 m in front of the main body and 0,8 m below the unit. For outdoor unit 1 m in front and 1 m in rear side of main body. The sound pressure is measured in accordance with JIS C 9612. Q-Lo: Quiet mode. Lo: The lowest set fan speed. 5) Add 70 mm for piping port.

Accessories

CZ-TACG1	Wi-Fi adapter for smart control via Panasonic Comfort Cloud App
CZ-CAPRA1	RAC interface adapter for integration into S-Link

Accessories

CZ-RD517C	Wired remote controller for wall-mounted and floor console
------------------	--



SEER: For KIT-BZ50-ZKE. SCOP: For KIT-BZ25-ZKE. SUPER QUIET: For KIT-BZ25-ZKE and KIT-BZ35-ZKE. INTERNET CONTROL: Optional.

Rating conditions: Cooling indoor 27 °C DB / 19 °C WB. Cooling outdoor 35 °C DB / 24 °C WB. Heating indoor 20 °C DB. Heating outdoor 7 °C DB / 6 °C WB. (DB: Dry Bulb; WB: Wet Bulb). Specifications subject to change without notice. For detailed information about ErP / Energy Labelling, please visit our websites www.aircon.panasonic.eu or www.ptc.panasonic.eu.

NEW Wall-mounted UZ super-compact · R32

- Compact design with only 779 mm wide
- Dust Collection Filter
- Super Quiet! Only 20 dB(A)
- Aerowings to control air draft direction
- High energy savings
- Cooling even at -10 °C
- Optional internet and voice control



Kit			KIT-UZ25-ZKE	KIT-UZ35-ZKE	KIT-UZ50-ZKE
Cooling capacity	Nominal (Min - Max)	kW	2,50 (0,85 - 3,00)	3,30 (0,85 - 3,90)	5,00 (0,98 - 5,40)
EER ¹⁾	Nominal (Min - Max)	W/W	3,68 (4,05 - 3,33)	3,24 (3,54 - 3,00)	3,03 (3,92 - 2,89)
SEER ²⁾			6,20 A++	6,20 A++	6,50 A++
Pdesign (cooling)		kW	2,5	3,3	5
Input power	Nominal (Min - Max)	kW	0,68 (0,21 - 0,90)	1,02 (0,24 - 1,30)	1,65 (0,25 - 1,87)
Annual energy consumption ³⁾		kWh/a	141	186	269
Heating capacity	Nominal (Min - Max)	kW	3,15 (0,80 - 3,60)	3,70 (0,80 - 4,40)	5,40 (0,98 - 7,40)
Heating capacity at -7 °C		kW	2,14	2,60	4,52
COP ¹⁾	Nominal (Min - Max)	W/W	4,06 (4,21 - 3,50)	3,72 (4,10 - 3,46)	3,42 (4,67 - 3,08)
SCOP ²⁾			4,20 A+	4,10 A+	4,10 A+
Pdesign at -10 °C		kW	1,9	2,4	4
Input power	Nominal (Min - Max)	kW	0,78 (0,19 - 1,03)	1,00 (0,20 - 1,27)	1,58 (0,21 - 2,40)
Annual energy consumption ³⁾		kWh/a	633	820	1366
Indoor unit			CS-UZ25ZKE	CS-UZ35ZKE	CS-UZ50ZKE
Power supply		V	230	230	230
Recommended fuse		A	16	16	16
Connection indoor / outdoor		mm ²	4 x 1,5	4 x 1,5	4 x 2,5
Air flow	Cool / Heat	m ³ /min	10,5/9,5	10,8/11,3	12,5/13,2
Moisture removal volume		L/h	1,5	1,9	2,8
Sound pressure ⁴⁾	Cool (Hi / Lo / Q-Lo)	dB(A)	37/26/20	38/30/20	44/37/34
	Heat (Hi / Lo / Q-Lo)	dB(A)	36/27/24	38/33/25	44/37/34
Dimension	H x W x D	mm	290 x 779 x 209	290 x 779 x 209	290 x 779 x 209
Net weight		kg	8	8	8
Outdoor unit			CU-UZ25ZKE	CU-UZ35ZKE	CU-UZ50ZKE
Air flow	Cool / Heat	m ³ /min	30,4/30,4	31,1/30,4	32,7/32,7
Sound pressure ⁴⁾	Cool / Heat (Hi)	dB(A)	48/49	48/50	48/49
Dimension ⁵⁾	H x W x D	mm	542 x 780 x 289	542 x 780 x 289	619 x 824 x 299
Net weight		kg	24	25	35
Piping diameter	Liquid	Inch (mm)	1/4 (6,35)	1/4 (6,35)	1/4 (6,35)
	Gas	Inch (mm)	3/8 (9,52)	3/8 (9,52)	1/2 (12,70)
Pipe length range		m	3 ~ 15	3 ~ 15	3 ~ 15
Elevation difference (in / out)		m	15	15	15
Pre-charged pipe length		m	7,5	7,5	10
Additional gas amount		g/m	10	10	15
Refrigerant (R32) / CO ₂ Eq.		kg / T	0,52/0,35	0,61/0,41	1,07/0,72
Operating range	Cool Min ~ Max	°C	-10 ~ +43	-10 ~ +43	-10 ~ +43
	Heat Min ~ Max	°C	-15 ~ +24	-15 ~ +24	-15 ~ +24

1) EER and COP calculation is based in accordance to EN14511. 2) Energy Label Scale from A+++ to D. 3) The annual energy consumption is calculated in accordance to EU/626/2011. 4) The sound pressure of the indoor unit shows the value measured of a position of 1 m in front of the main body and 0,8 m below the unit. For outdoor unit 1 m in front and 1 m in rear side of main body. The sound pressure is measured in accordance with JIS C 9612. Q-Lo: Quiet mode. Lo: The lowest set fan speed. 5) Add 70 mm for piping port.

Accessories

CZ-TACG1	Wi-Fi adapter for smart control via Panasonic Comfort Cloud App
CZ-CAPRA1	RAC interface adapter for integration into S-Link

Accessories

CZ-RD517C	Wired remote controller for wall-mounted and floor console
------------------	--



SEER: For KIT-UZ50-ZKE. SCOP: For KIT-UZ25-ZKE. SUPER QUIET: For KIT-UZ25-ZKE and KIT-UZ35-ZKE. INTERNET CONTROL: Optional.

Floor console · R32

- nanoe™ X technology to improve protection 24/7 (nanoe X Generator Mark 1)
- Stylish Sky remote controller
- A breakthrough design that integrates perfectly with the most modern environments
- High energy efficiency class A++ SEER and A++ SCOP
- Optional internet and voice control



Kit			KIT-Z25-UFE	KIT-Z35-UFE	KIT-Z50-UFE
Cooling capacity	Nominal (Min - Max)	kW	2,50 [0,85 - 3,40]	3,50 [0,85 - 3,80]	5,00 [0,90 - 5,70]
EER ¹⁾	Nominal (Min - Max)	W/W	4,81 [3,54 - 3,78]	4,07 [3,54 - 3,73]	3,60 [3,53 - 3,15]
SEER ²⁾			7,90 A++	8,10 A++	6,70 A++
Pdesign (cooling)		kW	2,50	3,50	5,00
Input power	Nominal (Min - Max)	kW	0,52 [0,24 - 0,90]	0,86 [0,24 - 1,02]	1,39 [0,26 - 1,81]
Annual energy consumption ³⁾		kWh/a	111	151	261
Heating capacity	Nominal (Min - Max)	kW	3,40 [0,85 - 5,00]	4,30 [0,85 - 6,00]	5,80 [0,90 - 8,10]
Heating capacity at -7 °C		kW	2,88	3,37	5,03
COP ¹⁾	Nominal (Min - Max)	W/W	4,47 [3,54 - 3,70]	3,98 [3,54 - 3,43]	3,74 [3,46 - 3,12]
SCOP ²⁾			4,60 A++	4,60 A++	4,30 A+
Pdesign at -10 °C		kW	2,70	3,20	4,40
Input power	Nominal (Min - Max)	kW	0,76 [0,24 - 1,35]	1,08 [0,24 - 1,75]	1,55 [0,26 - 2,60]
Annual energy consumption ³⁾		kWh/a	822	974	1433
Indoor unit			CS-Z25UFEAW	CS-Z35UFEAW	CS-Z50UFEAW
Air flow	Cool / Heat	m ³ /min	9,6/9,9	9,9/10,1	11,6/13,2
Moisture removal volume		L/h	1,5	2,0	2,8
Sound pressure ⁴⁾	Cool (Hi / Lo / Q-Lo)	dB(A)	38/25/20	39/26/20	44/31/27
	Heat (Hi / Lo / Q-Lo)	dB(A)	38/25/19	39/26/19	46/33/29
Dimension	H x W x D	mm	600 x 750 x 207	600 x 750 x 207	600 x 750 x 207
Net weight		kg	13	13	13
nanoe X Generator			Mark 1	Mark 1	Mark 1
Outdoor unit			CU-Z25UBEA	CU-Z35UBEA	CU-Z50UBEA
Power supply		V	230	230	230
Recommended fuse		A	16	16	16
Connection indoor / outdoor		mm ²	4 x 1,5	4 x 1,5	4 x 1,5
Air flow	Cool / Heat	m ³ /min	28,7/27,2	34,3/33,5	39,7/38,6
Sound pressure ⁴⁾	Cool / Heat (Hi)	dB(A)	46/47	48/48	48/48
Dimension ⁵⁾	H x W x D	mm	542 x 780 x 289	619 x 824 x 299	695 x 875 x 320
Net weight		kg	33	35	43
Piping diameter	Liquid	Inch (mm)	1/4 (6,35)	1/4 (6,35)	1/4 (6,35)
	Gas	Inch (mm)	3/8 (9,52)	3/8 (9,52)	1/2 (12,70)
Pipe length range		m	3 - 20	3 - 20	3 - 30
Elevation difference (in / out)		m	15	15	20
Pre-charged pipe length		m	7,5	7,5	7,5
Additional gas amount		g/m	10	10	15
Refrigerant [R32] / CO ₂ Eq.		kg / T	0,88/0,594	0,93/0,628	1,13/0,763
Operating range	Cool Min ~ Max	°C	-10 ~ +43	-10 ~ +43	-10 ~ +43
	Heat Min ~ Max	°C	-15 ~ +24	-15 ~ +24	-15 ~ +24

1) EER and COP calculation is based in accordance to EN14511. 2) Energy Label Scale from A+++ to D. 3) The annual energy consumption is calculated in accordance to EU/626/2011. 4) The sound pressure of the units shows the value measured of a position 1 m in front of the main body and 1 m above floor. The sound pressure is measured in accordance with JIS C 9612. Q-Lo: Quiet mode. Lo: The lowest set fan speed. 5) Add 70 mm for piping port.

Accessories

CZ-TACG1	Wi-Fi adapter for smart control via Panasonic Comfort Cloud App
CZ-CAPRA1	RAC interface adapter for integration into S-Link

Accessories

CZ-RD517C	Wired remote controller for wall-mounted and floor console
------------------	--



SEER and SCOP: For KIT-Z35-UFE. SUPER QUIET: For KIT-Z25-UFE and KIT-Z35-UFE. INTERNET CONTROL: Optional. IF DESIGN AWARD 2019: Floor console awarded with the prestigious IF Design Award 2019.

Rating conditions: Cooling indoor 27 °C DB / 19 °C WB. Cooling outdoor 35 °C DB / 24 °C WB. Heating indoor 20 °C DB. Heating outdoor 7 °C DB / 6 °C WB. (DB: Dry Bulb; WB: Wet Bulb). Specifications subject to change without notice. For detailed information about ErP / Energy Labelling, please visit our websites www.aircon.panasonic.eu or www.ptc.panasonic.eu.

Low static pressure hide-away · R32

- Duct type can be controlled by KNX and Modbus
- Eco mode for 20% energy saving
- Extremely compact indoor units without losing static pressure (only 200 mm high)
- Weekly timer, 42 settings per week
- Easy check mode for failure detection
- Drain pump included



+ MORE DUCT TYPE SOLUTIONS IN PACI SECTION

Kit			KIT-Z25-UD3	KIT-Z35-UD3	KIT-Z50-UD3	KIT-Z60-UD3
Cooling capacity	Nominal (Min - Max)	kW	2,50 (0,85 - 3,20)	3,50 (0,85 - 4,00)	5,10 (0,90 - 5,70)	6,00 (0,90 - 6,50)
EER ¹⁾	Nominal (Min - Max)	W/W	4,31 (3,54 - 3,76)	3,85 (3,54 - 3,36)	3,27 (3,53 - 3,20)	2,94 (3,53 - 2,83)
SEER ²⁾			5,90 A+	5,80 A+	5,90 A+	5,60 A+
Pdesign (cooling)		kW	2,50	3,50	5,10	6,00
Input power	Nominal (Min - Max)	kW	0,58 (0,24 - 0,85)	0,91 (0,24 - 1,19)	1,56 (0,26 - 1,78)	2,04 (0,26 - 2,30)
Annual energy consumption ³⁾		kWh/a	148	211	303	375
Heating capacity	Nominal (Min - Max)	kW	3,20 (0,85 - 4,60)	4,20 (0,85 - 5,10)	6,10 (0,90 - 7,20)	7,00 (0,90 - 8,00)
Heating capacity at -7 °C		kW	2,60	3,00	4,50	5,10
COP ¹⁾	Nominal (Min - Max)	W/W	4,00 (3,70 - 3,68)	3,82 (3,70 - 3,59)	3,35 (3,46 - 3,27)	3,24 (3,46 - 3,08)
SCOP ²⁾			4,20 A+	4,10 A+	4,10 A+	4,10 A+
Pdesign at -10 °C		kW	2,60	2,80	4,00	4,60
Input power	Nominal (Min - Max)	kW	0,80 (0,23 - 1,25)	1,10 (0,23 - 1,42)	1,82 (0,26 - 2,20)	2,16 (0,26 - 2,60)
Annual energy consumption ³⁾		kWh/a	867	956	1366	1571
Indoor unit			CS-Z25UD3EAW	CS-Z35UD3EAW	CS-Z50UD3EAW	CS-Z60UD3EAW
External static pressure ⁴⁾	Min - Max	Pa	15 - 45	15 - 45	15 - 50	15 - 50
Air flow	Cool / Heat	m ³ /min	10,5/10,5	11,2/11,2	15,3/15,3	15,7/15,7
Moisture removal volume		L/h	1,5	2,0	2,8	3,3
Sound pressure ⁵⁾	Cool (Hi / Lo / Q-Lo)	dB(A)	33/27/24	33/27/24	39/29/26	41/30/27
	Heat (Hi / Lo / Q-Lo)	dB(A)	35/27/24	35/27/24	39/30/27	41/32/29
Dimension	H x W x D	mm	200 x 750 x 640	200 x 750 x 640	200 x 750 x 640	200 x 750 x 640
Net weight		kg	19	19	19	19
Outdoor unit			CU-Z25UBEA	CU-Z35UBEA	CU-Z50UBEA	CU-Z60UBEA
Power supply		V	230	230	230	230
Recommended fuse		A	16	16	16	—
Connection indoor / outdoor		mm ²	4 x 1,5 - 2,5	4 x 1,5 - 2,5	4 x 1,5 - 2,5	—
Air flow	Cool / Heat	m ³ /min	28,7/27,2	34,3/33,5	39,7/38,6	42,6/41,5
Sound pressure ⁵⁾	Cool / Heat (Hi)	dB(A)	46/47	48/48	48/48	49/50
Dimension ⁶⁾	H x W x D	mm	542 x 780 x 289	619 x 824 x 299	695 x 875 x 320	695 x 875 x 320
Net weight		kg	33	35	43	43
Piping diameter	Liquid	Inch (mm)	1/4 (6,35)	1/4 (6,35)	1/4 (6,35)	1/4 (6,35)
	Gas	Inch (mm)	3/8 (9,52)	3/8 (9,52)	1/2 (12,70)	1/2 (12,70)
Pipe length range		m	3 - 20	3 - 20	3 - 30	3 - 30
Elevation difference (in / out)		m	15	15	20	20
Pre-charged pipe length		m	7,5	7,5	7,5	7,5
Additional gas amount		g/m	10	10	15	15
Refrigerant (R32) / CO ₂ Eq.		kg / T	0,88 / 0,594	0,93 / 0,628	1,13 / 0,763	1,13 / 0,763
Operating range	Cool Min ~ Max	°C	-10 ~ +43	-10 ~ +43	-10 ~ +43	-10 ~ +43
	Heat Min ~ Max	°C	-15 ~ +24	-15 ~ +24	-15 ~ +24	-15 ~ +24

1) EER and COP calculation is based in accordance to EN14511. 2) Energy Label Scale from A+++ to D. 3) The annual energy consumption is calculated in accordance to EU/626/2011. 4) The specification listed on the table indicates values under the condition of 25 Pa (2,5 mmAq) which are applied for factory default setting. Change switch on PCB from Hi to S-Hi to have more than 6,0 mmAq. 5) The sound pressure of the indoor unit shows the value measured of a position of 1,5 m below the unit with 1 m duct on the suction side and 2 m duct on the discharge side. For outdoor unit 1 m in front and 1 m in rear side of main body. The sound pressure is measured in accordance with JIS C 9612. 6) Add 100 mm for indoor unit or 70 mm for outdoor unit for piping port.

Accessories

CZ-TACG1 Wi-Fi adapter for smart control via Panasonic Comfort Cloud App

Accessories

CZ-CAPRA1 RAC interface adapter for integration into S-Link
CZ-RL511D Optional wireless control kit



SEER and SCOP: For KIT-Z25-UD3. INTERNET CONTROL: Optional.

Free Multi system

If air conditioning requirements exceed the scope of a single room, Panasonic offers an extensive range of possibilities with a multi split solution.

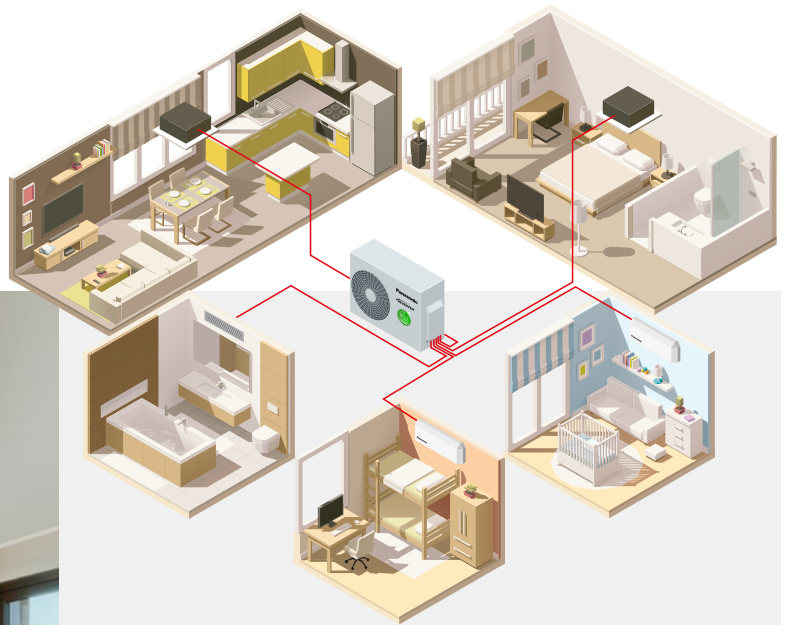

The multi split solution offers high flexibility, as 2 to 5 indoor units can be connected to a single outdoor unit. The wide range of compatible indoor units includes Etherea and TZ wall-mounted units, floor console, 4 way 60x60 cassette and low static pressure hide-away.

Full flexibility up to 9,0 kW and up to 5 ports with wide range of indoor units including high performance Etherea indoor units, reaching up to A+++ / A++.

Why a multi split is better than several separate split units

Up to 5 indoor units with a single outdoor unit.

- Just one compact outdoor unit
- Increased comfort in the house since every room has its own indoor unit for heating or cooling
- Much more powerful than a single split

- More efficient since the units are always operating at full capacity
- You can connect all types of indoor units, such as wall types and consoles, depending on what suits your house best

Solution with single split.

One indoor unit is connected to one outdoor unit. The indoor unit is placed in the main hallway and heats the entire house. Certain rooms may not be perfectly heated, which causes inadequate comfort.

Solution with multi split.

With one outdoor unit, you can connect up to five indoor units. There is one indoor unit per room or area. It gives an extreme increase in comfort levels. On the roof, there is only one outdoor unit.

1. Laundry room. 2. Entrance. 3. Kitchen / dining area. 4. Bathroom. 5. Living room. 6. Bedroom.

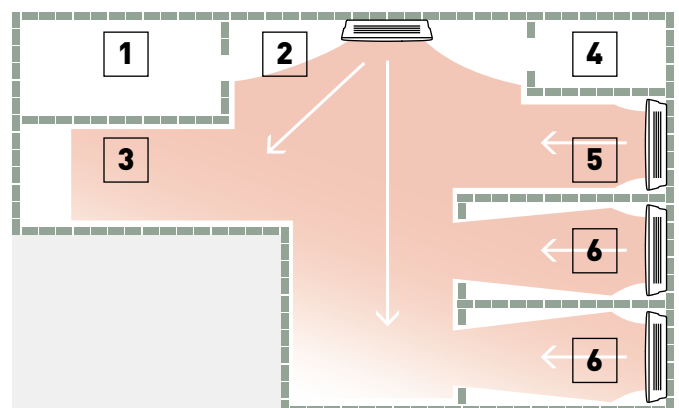
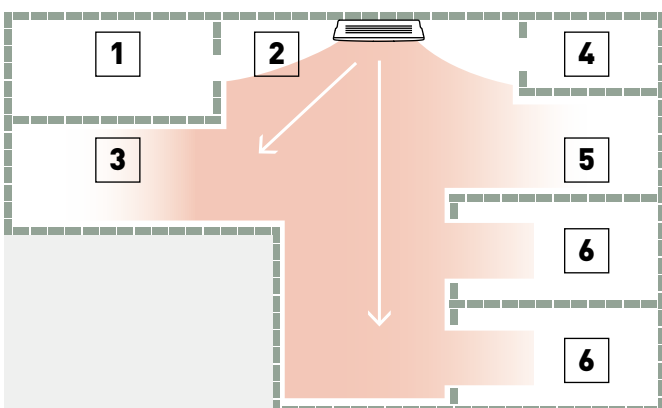

Free Multi system

Outdoor units Free Multi system Z · R32

- Up to 5 indoor units with a single outdoor unit
- Up to 5 rooms with individual control
- Etherea, TZ super-compact, floor console and 4 way 60x60 cassette with nanoe™ X technology to improve protection 24/7
- High energy efficiency class A+++ SEER
- Indoor units compatible with internet and voice control

Configure in a few steps your multi split system with our online tool.



Outdoor unit			CU-2Z35TBE	CU-2Z41TBE	CU-2Z50TBE	CU-3Z52TBE	CU-3Z68TBE	CU-4Z68TBE	CU-4Z80TBE	CU-5Z90TBE
Indoor nominal capacity (Min - Max)			3,2~6,0 kW	3,2~6,0 kW	3,2~7,7 kW	4,5~9,5 kW	4,5~11,2 kW	4,5~11,5 kW	4,5~14,7 kW	4,5~18,3 kW
Cooling capacity	Nominal	kW	3,50	4,10	5,00	5,20	6,80	6,80	8,00	9,00
	Min		1,50	1,50	1,50	1,80	1,90	1,90	3,00	2,90
	Max		4,50	5,20	5,40	7,30	8,00	8,80	9,20	11,50
EER ¹⁾	Nominal	W/W	4,86	4,56	4,24	4,77	3,66	4,39	4,04	4,09
	Min		6,00	6,00	6,00	—	7,04	5,59	5,66	5,27
	Max		4,09	3,80	3,62	—	3,38	3,56	3,21	2,98
SEER ²⁾			8,50 A+++	8,50 A+++	8,50 A+++	8,50 A+++	8,00 A++	8,00 A++	7,90 A++	8,50 A+++
Pdesign (cooling)		kW	3,50	4,10	5,00	5,20	6,80	6,80	8,00	9,00
Input power	Nominal	kW	0,72	0,90	1,18	1,09	1,86	1,55	1,98	2,20
	Min		0,25	0,25	0,25	0,36	0,27	0,34	0,53	0,55
	Max		1,10	1,37	1,49	2,18	2,37	2,47	2,87	3,86
Annual energy consumption ³⁾		kWh/a	144	169	206	214	298	298	990	1100
Heating capacity	Nominal	kW	4,20	4,60	5,60	6,80	8,50	8,50	9,40	10,40
	Min		1,10	1,10	1,10	1,60	3,30	3,00	4,20	3,40
	Max		5,60	7,00	7,20	8,30	10,40	10,60	10,60	14,50
Heating capacity at -7 °C		kW	3,39	4,18	4,28	3,95	4,45	4,45	6,42	8,62
COP ¹⁾	Nominal	W/W	4,88	4,79	4,63	4,63	3,95	4,47	4,63	4,84
	Min		5,24	5,24	5,24	5,00	5,32	5,17	6,00	6,42
	Max		4,18	3,91	4,00	3,82	3,64	3,96	3,46	3,42
SCOP ²⁾			4,60 A++	4,60 A++	4,60 A++	4,20 A+	4,20 A+	4,20 A+	4,70 A++	4,68 A++
Pdesign at -10 °C		kW	3,20	3,50	4,20	5,00	5,20	5,80	6,80	8,50
Input power	Nominal	kW	0,86	0,96	1,21	1,47	2,15	1,90	2,03	2,15
	Min		0,21	0,21	0,21	0,32	0,62	0,58	0,70	0,53
	Max		1,34	1,79	1,80	2,17	2,86	2,68	3,06	4,24
Annual energy consumption ³⁾		kWh/a	974	1065	1278	1667	1733	1933	2026	2543
Current	Cool / Heat	A	3,35/4,00	4,15/4,45	5,35/5,50	5,00/6,70	8,40/9,70	7,00/8,60	9,50/9,50	10,50/10,10
Power supply		V	230	230	230	230	230	230	230	230
Recommended fuse		A	16	16	16	16	16	20	20	25
Recommended power cable section		mm ²	2,5	2,5	2,5	2,5	2,5	2,5	2,5	4,0
Sound pressure ⁴⁾	Cool / Heat (Hi)	dB(A)	48/50	48/50	50/52	47/48	51/52	49/50	51/52	53/54
Dimension ⁵⁾	HxWxD	mm	619x824x299	619x824x299	619x824x299	795x875x320	795x875x320	795x875x320	999x940x340	999x940x340
Net weight		kg	39	39	39	71	71	72	80	81
Piping diameter	Liquid	Inch (mm)	1/4 (6,35)	1/4 (6,35)	1/4 (6,35)	1/4 (6,35)	1/4 (6,35)	1/4 (6,35)	1/4 (6,35)	1/4 (6,35)
	Gas	Inch (mm)	3/8 (9,52)	3/8 (9,52)	3/8 (9,52)	3/8 (9,52)	3/8 (9,52)	3/8 (9,52)	3/8 (9,52)	3/8 (9,52)
Pipe length range total ⁶⁾		m	6~30	6~30	6~30	6~50	6~60	6~60	6~70	6~80
Pipe length range to one unit		m	3~20	3~20	3~20	3~25	3~25	3~25	3~25	3~25
Elevation difference (in / out)		m	10	10	10	15	15	15	15	15
Pre-charged pipe length		m	20	20	20	30	30	30	45	45
Additional gas amount		g/m	15	15	15	20	20	20	20	20
Refrigerant (R32) / CO ₂ Eq.		kg / T	1,12/0,756	1,12/0,756	1,12/0,756	2,10/1,418	2,10/1,418	2,10/1,418	2,72/1,836	2,72/1,836
Operating range	Cool Min ~ Max	°C	-10~+46	-10~+46	-10~+46	-10~+46	-10~+46	-10~+46	-10~+46	-10~+46
	Heat Min ~ Max	°C	-15~+24	-15~+24	-15~+24	-15~+24	-15~+24	-15~+24	-15~+24	-15~+24

1) EER and COP calculation is based in accordance to EN14511. 2) Energy Label Scale from A+++ to D. 3) The annual energy consumption is calculated in accordance to EU/626/2011. 4) The sound pressure of the units shows the value measured of a position 1 m in front and 1 m in rear side of the main body. The sound pressure is measured in accordance with JIS C 9612. 5) Add 70 or 95 mm for piping port. 6) Minimum piping length is 3 meters per indoor unit.

Possible outdoor / indoor units combinations

Rooms	Outdoor unit	Indoor capacity connected (Min - Max)	NEW Wall-mounted Etherea							NEW Wall-mounted TZ super-compact							Floor console				4 Way 60x60 cassette				Low static pressure hide-away					
			16	20	25	35	42	50	71	16	20	25	35	42	50	60	71	20	25	35	50	20	25	35	50	60	20	25	35	50
2	CU-2Z35TBE	3,2~6,0 kW	•	•	•	•	•																							
	CU-2Z41TBE	3,2~6,0 kW	•	•	•	•	•																							
	CU-2Z50TBE	3,2~7,7 kW	•	•	•	•	•	•																						
3	CU-3Z52TBE	4,5~9,5 kW	•	•	•	•	•	•																						
	CU-3Z68TBE	4,5~11,2 kW	•	•	•	•	•	•	•																					
4	CU-4Z68TBE	4,5~11,5 kW	•	•	•	•	•	•	•																					
	CU-4Z80TBE	4,5~14,7 kW	•	•	•	•	•	•	•	•																				
5	CU-5Z90TBE	4,5~18,3 kW	•	•	•	•	•	•	•	•																				

1) Pipe reducer CZ-MA1PA required. 2) Pipe reducer CZ-MA2PA required. 3) Pipe reducers CZ-MA2PA and CZ-MA3PA required.





Optional wired remote controller. CZ-RD517C

INTERNET CONTROL: Built-in Wi-Fi.



NEW Wall-mounted Etherea	Indoor unit graphite grey	Indoor unit silver	Indoor unit matt white	Cooling capacity	Heating capacity	Connection in. / out.	Sound pressure ¹⁾		Dimension / Net weight	Piping diameter
							Cool — Heat (Hi/Lo/S-Lo)	dB(A)		
1,6 kW	—	—	CS-MZ16ZKE	1,60	2,60	4x1,5	38/26/21	— 39/27/21	295x870x229/10	1/4(6,35)/3/8(9,52)
2,0 kW	CS-XZ20ZKEW-H	CS-XZ20ZKEW	CS-Z20ZKEW	2,00	3,20	4x1,5	39/26/21	— 40/27/21	295x870x229/10	1/4(6,35)/3/8(9,52)
2,5 kW	CS-XZ25ZKEW-H	CS-XZ25ZKEW	CS-Z25ZKEW	2,50	3,60	4x1,5	41/27/21	— 43/29/21	295x870x229/10	1/4(6,35)/3/8(9,52)
3,5 kW ²⁾	CS-XZ35ZKEW-H	CS-XZ35ZKEW	CS-Z35ZKEW	3,50	4,50	4x1,5	44/30/21	— 45/35/21	295x870x229/11	1/4(6,35)/3/8(9,52)
4,2 kW ³⁾	CS-XZ42ZKEW-H	—	CS-Z42ZKEW	4,20	5,60	4x1,5	44/33/27	— 45/37/31	295x870x229/10	1/4(6,35)/1/2(12,70)
5,0 kW ⁴⁾	—	CS-XZ50ZKEW	CS-Z50ZKEW	5,00	6,80	4x2,5	44/39/32	— 46/39/32	295x1040x244/12	1/4(6,35)/1/2(12,70)
7,1 kW	—	—	CS-Z71ZKEW	7,10	8,70	4x2,5	49/40/32	— 49/40/32	295x1040x244/13	1/4(6,35)/5/8(15,88)

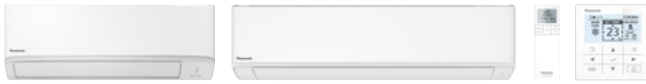

Optional wired remote controller. CZ-RD517C

INTERNET CONTROL: Built-in Wi-Fi.



NEW Wall-mounted TZ super-compact	Indoor unit	Cooling capacity	Heating capacity	Connection in. / out.	Sound pressure ¹⁾		Dimension / Net weight	Piping diameter
					Cool — Heat (Hi/Lo/S-Lo)	dB(A)		
1,6 kW	CS-MTZ16ZKE	1,60	2,60	4x1,5	38/27/22	— 39/28/24	290x779x209/8	1/4(6,35)/3/8(9,52)
2,0 kW	CS-TZ20ZKEW	2,00	3,20	4x1,5	37/25/20	— 38/26/22	290x779x209/8	1/4(6,35)/3/8(9,52)
2,5 kW	CS-TZ25ZKEW	2,50	3,60	4x1,5	40/26/20	— 40/27/22	290x779x209/8	1/4(6,35)/3/8(9,52)
3,5 kW ²⁾	CS-TZ35ZKEW	3,50	4,50	4x1,5	42/30/20	— 42/33/22	290x779x209/8	1/4(6,35)/3/8(9,52)
4,2 kW	CS-TZ42ZKEW	4,20	5,60	4x1,5	44/31/29	— 44/35/34	290x779x209/8	1/4(6,35)/1/2(12,70)
5,0 kW	CS-TZ50ZKEW	5,00	6,80	4x2,5	44/37/33	— 44/37/33	290x779x209/8	1/4(6,35)/1/2(12,70)
6,0 kW	CS-TZ60ZKEW	6,00	8,50	4x2,5	45/37/34	— 45/37/34	302x1102x244/12	1/4(6,35)/1/2(12,70)
7,1 kW	CS-TZ71ZKEW	7,10	8,70	4x2,5	47/38/35	— 47/38/35	302x1102x244/13	1/4(6,35)/5/8(15,88)



Optional wired remote controller. CZ-RD517C

INTERNET CONTROL: Optional.



Floor console ⁵⁾	Indoor unit	Cooling capacity	Heating capacity	Connection in. / out.	Sound pressure ⁶⁾		Dimension / Net weight	Piping diameter
					Cool — Heat (Hi/Lo/S-Lo)	dB(A)		
2,0 kW	CS-MZ20UFEA	2,00	3,20	4x1,5	39/27/22	— 39/27/21	600x750x207/13	1/4(6,35)/3/8(9,52)
2,5 kW	CS-Z25UFEAW	2,50	3,60	4x1,5	40/27/22	— 40/27/21	600x750x207/13	1/4(6,35)/3/8(9,52)
3,5 kW ²⁾	CS-Z35UFEAW	3,50	4,50	4x1,5	41/28/22	— 41/28/21	600x750x207/13	1/4(6,35)/3/8(9,52)
5,0 kW	CS-Z50UFEAW	5,00	5,30	4x1,5	44/33/29	— 48/35/31	600x750x207/13	1/4(6,35)/1/2(12,70)

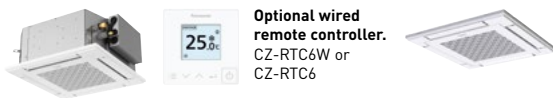

Optional wired remote controller. CZ-RTC6W or CZ-RTC6

Panel (sold separately). CZ-KPY4

INTERNET CONTROL and BMS CONNECTIVITY: Optional.



4 Way 60x60 cassette*	Indoor unit (Panel CZ-KPY4)	Cooling capacity	Heating capacity	Connection in. / out.	Sound pressure ⁷⁾		Dimension / Net weight		Piping diameter
					Cool — Heat (Hi/Lo/S-Lo)	dB(A)	Indoor HxWxD	Panel HxWxD	
2,0 kW	S-M20PY3E	2,00	3,20	4x1,5	33/30/27	— 33/30/27	243x575x575/15	30x625x625/2,8	1/4(6,35)/1/2(12,70)
2,5 kW	S-25PY3E	2,50	3,60	4x1,5	33/30/27	— 33/30/27	243x575x575/15	30x625x625/2,8	1/4(6,35)/1/2(12,70)
3,5 kW ²⁾	S-36PY3E	3,50	3,60	4x1,5	36/32/27	— 36/32/27	243x575x575/15	30x625x625/2,8	1/4(6,35)/1/2(12,70)
5,0 kW ⁴⁾	S-50PY3E	5,00	6,80	4x1,5	41/36/29	— 41/36/29	243x575x575/15	30x625x625/2,8	1/4(6,35)/1/2(12,70)
6,0 kW	S-60PY3E	6,00	8,50	4x1,5	45/39/33	— 45/39/33	243x575x575/15	30x625x625/2,8	3/8(9,52)/5/8(15,88)

* Compatible with Commercial control and connectivity accessories only. For detailed information go to the control systems section.



Optional wireless control kit. CZ-RL511D

INTERNET CONTROL and BMS CONNECTIVITY: Optional.



Low static pressure hide-away	Indoor unit	Cooling capacity	Heating capacity	Connection in. / out.	Sound pressure ⁸⁾		Dimension / Net weight	Piping diameter
					Cool — Heat (Hi/Lo/S-Lo)	dB(A)		
2,0 kW	CS-MZ20UD3EA	2,00	3,20	4x1,5	34/29/26	— 36/29/26	200x750x640/19	1/4(6,35)/3/8(9,52)
2,5 kW	CS-Z25UD3EAW	2,50	3,60	4x1,5	35/29/26	— 37/29/26	200x750x640/19	1/4(6,35)/3/8(9,52)
3,5 kW ²⁾	CS-Z35UD3EAW	3,50	4,50	4x1,5	35/29/26	— 37/29/26	200x750x640/19	1/4(6,35)/3/8(9,52)
5,0 kW ⁴⁾	CS-Z50UD3EAW	5,00	6,80	4x1,5	41/31/28	— 41/32/29	200x750x640/19	1/4(6,35)/1/2(12,70)
6,0 kW	CS-Z60UD3EAW	6,00	8,50	4x1,5	43/32/29	— 43/34/31	200x750x640/19	1/4(6,35)/1/2(12,70)

1) The sound pressure of the indoor unit shows the value measured at a position of 1 m in front of the main body and 0,8 m below the unit. The sound pressure is measured in accordance with JIS C 9612. Q-Lo: Quiet mode. Lo: The lowest set fan speed. 2) Heating capacity in combination with Free Multi outdoor units except with CU-Z235TBE. In this case, the heating capacity is 4,20 kW. 3) Heating capacity in combination with Free Multi outdoor units except with CU-Z250TBE. In this case, the heating capacity is 5,00 kW. 4) Heating capacity in combination with Free Multi outdoor units except with CU-Z235TBE. In this case, the heating capacity is 5,30 kW. 5) Compatible only with 2 ports R32 outdoor CU-Z235TBE / CU-Z241TBE / CU-Z250TBE. Minimum quantity of connection: 2 indoor units. 6) The sound pressure of the units shows the value measured at a position 1 m in front of the main body and 1 m above floor. The sound pressure is measured in accordance with JIS C 9612. Q-Lo: Quiet mode. Lo: The lowest set fan speed. 7) The sound pressure of the indoor unit shows the value measured at a position of 1,5 m below the unit. The sound pressure is measured in accordance with JIS C 9612. Q-Lo: Quiet mode. Lo: The lowest set fan speed. 8) The sound pressure of the indoor unit shows the value measured at a position of 1,5 m below the unit with 1 m duct on the suction side and 2 m duct on the discharge side. The sound pressure is measured in accordance with JIS C 9612.

Multi TZ system

Outdoor units Multi TZ · R32

- Up to 3 indoor units with a single outdoor unit
- Up to 3 rooms with individual control
- High energy efficiency class A++ SEER
- Flexible installation, compact units and large connection distance
- Indoor units compatible with internet and voice control



Outdoor unit			CU-2TZ41TBE	CU-2TZ50TBE	CU-3TZ52TBE
Indoor nominal capacity (Min - Max)			3,2 ~ 6,0 kW	3,2 ~ 7,7 kW	4,5 ~ 9,5 kW
Cooling capacity	Nominal (Min - Max)	kW	4,10 [1,50 - 4,70]	5,00 [1,50 - 5,40]	5,20 [1,80 - 6,60]
EER ¹⁾	Nominal (Min - Max)	W/W	4,14 [5,56 - 3,41]	3,85 [5,56 - 3,33]	4,52 [3,67 - 5,00]
SEER ²⁾			7,10 A++	7,00 A++	7,60 A++
Pdesign (cooling)		kW	4,10	5,00	5,20
Input power	Nominal (Min - Max)	kW	0,99 [0,27 - 1,38]	1,30 [0,27 - 1,62]	1,15 [0,36 - 1,80]
Annual energy consumption ³⁾		kWh/a	202	250	239
Heating capacity	Nominal (Min - Max)	kW	4,40 [1,10 - 6,30]	5,70 [1,10 - 6,40]	6,80 [1,60 - 7,50]
Heating capacity at -7 °C		kW	3,75	3,80	—
COP ¹⁾	Nominal (Min - Max)	W/W	4,44 [5,00 - 3,54]	4,35 [5,00 - 3,62]	4,28 [3,87 - 5,00]
SCOP ²⁾			4,30 A+	4,20 A+	4,20 A+
Pdesign at -10 °C		kW	3,50	4,50	5,00
Input power	Nominal (Min - Max)	kW	0,99 [0,22 - 1,78]	1,31 [0,22 - 1,77]	1,59 [0,32 - 1,94]
Annual energy consumption ³⁾		kWh/a	1139	1500	1667
Current	Cool / Heat	A	4,60 / 4,60	6,00 / 6,00	5,30 / 7,30
Power supply		V	230	230	230
Sound pressure ⁴⁾	Cool / Heat (Hi)	dB(A)	48 / 50	50 / 52	48 / 48
Dimension ⁵⁾	H x W x D	mm	542 x 780 x 289	542 x 780 x 289	795 x 875 x 320
Net weight		kg	35	35	71
Piping diameter	Liquid	Inch (mm)	1/4 (6,35)	1/4 (6,35)	1/4 (6,35)
	Gas	Inch (mm)	3/8 (9,52)	3/8 (9,52)	3/8 (9,52)
Pipe length range total		m	6 ~ 30	6 ~ 30	6 ~ 50
Pipe length range to one unit		m	3 ~ 20	3 ~ 20	3 ~ 25
Elevation difference (in / out)		m	10	10	15
Pre-charged pipe length		m	20	20	30
Additional gas amount		g/m	15	15	20
Refrigerant (R32) / CO ₂ Eq.		kg / T	0,9 / 0,6075	0,9 / 0,6075	2,1 / 1,4175
Operating range	Cool Min ~ Max	°C	-10 ~ +46	-10 ~ +46	-10 ~ +46
	Heat Min ~ Max	°C	-15 ~ +24	-15 ~ +24	-15 ~ +24

1) EER and COP calculation is based in accordance to EN14511. 2) Energy Label Scale from A+++ to D. 3) The annual energy consumption is calculated in accordance to EU/626/2011. 4) The sound pressure of the units shows the value measured of a position 1 m in front and 1 m in rear side of the main body. The sound pressure is measured in accordance with JIS C 9612. 5) Add 70 or 95 mm for piping port.



Possible outdoor / indoor units combinations

Rooms	Outdoor unit	Indoor capacity connected (Min - Max)	NEW Wall-mounted TZ super-compact					
			16	20	25	35	42	50
2	CU-2TZ41TBE	3,2 ~ 6,0 kW	✓	✓	✓	✓		
	CU-2TZ50TBE	3,2 ~ 7,7 kW	✓	✓	✓	✓	✓	✓
3	CU-3TZ52TBE	4,5 ~ 9,5 kW	✓	✓	✓	✓	✓	✓

Minimum quantity of connection: 2 indoor units.









Optional wired remote controller. CZ-RD517C



NEW Wall-mounted TZ super-compact	Indoor unit	Cooling capacity	Heating capacity	Connection in. / out.	Sound pressure ¹⁾		Dimension / Net weight		Piping diameter	
					Cool — Heat (Hi/Lo/S-Lo)		H x W x D		Liquid / Gas	
					dB(A)		mm / kg		Inch (mm)	
1,6 kW	CS-MTZ16ZKE	1,60	2,60	4 x 1,5	38 / 27 / 22 — 39 / 28 / 24		290 x 779 x 209 / 8		1/4 (6,35) / 3/8 (9,52)	
2,0 kW	CS-TZ20ZKEW	2,00	3,20	4 x 1,5	37 / 25 / 20 — 38 / 26 / 22		290 x 779 x 209 / 8		1/4 (6,35) / 3/8 (9,52)	
2,5 kW	CS-TZ25ZKEW	2,50	3,60	4 x 1,5	40 / 26 / 20 — 40 / 27 / 22		290 x 779 x 209 / 8		1/4 (6,35) / 3/8 (9,52)	
3,5 kW	CS-TZ35ZKEW	3,50	4,50	4 x 1,5	42 / 30 / 20 — 42 / 33 / 22		290 x 779 x 209 / 8		1/4 (6,35) / 3/8 (9,52)	
4,2 kW	CS-TZ42ZKEW	4,20	5,60	4 x 1,5	44 / 31 / 29 — 44 / 35 / 34		290 x 779 x 209 / 8		1/4 (6,35) / 1/2 (12,70)	
5,0 kW	CS-TZ50ZKEW	5,00	6,80	4 x 2,5	44 / 37 / 33 — 44 / 37 / 33		290 x 779 x 209 / 8		1/4 (6,35) / 1/2 (12,70)	

1) The sound pressure of the indoor unit shows the value measured of a position of 1 m in front of the main body and 0,8 m below the unit. The sound pressure is measured in accordance with JIS C 9612. Q-Lo: Quiet mode. Lo: The lowest set fan speed.



































Compare solutions

	Color	Capacity	Indoor unit dimension	Efficiency ¹⁾	Indoor air quality	Outdoor temperature	Comfort	Super Quiet	Connectivity
Wall-mounted Heatcharge VZ 	White	2,5 to 3,5 kW	295 x 798 x 375	A+++ A+++	nanoe	-10 °C in cooling mode -30 °C in heating mode	Econavi sunlight detection sensor	18 dB(A)	Optional Wi-Fi CZ-TACG1
Wall-mounted Etherea 	Graphite grey / silver / matt white	2,0 to 7,1 kW	295 x 870 x 229 (295x1040x244 wide model)	A+++ A+++	nanoeX nanoe X Generator Mark 3	-10 °C in cooling mode -20 °C in heating mode	Aerowings 2.0	19 dB(A)	Built-in Wi-Fi
Wall-mounted TZ super-compact 	Matt white	2,0 to 7,1 kW	290 x 779 x 209 (295x1040x244 wide model)	A++ A++	nanoeX nanoe X Generator Mark 1	-10 °C in cooling mode -15 °C in heating mode	Aerowings	20 dB(A)	Built-in Wi-Fi
Wall-mounted BZ super-compact 	Matt white	2,5 to 6,0 kW	290 x 779 x 209	A++ A+	PM2,5 Filter	-10 °C in cooling mode -15 °C in heating mode	Aerowings	20 dB(A)	Optional Wi-Fi CZ-TACG1
Wall-mounted UZ super-compact 	Matt white	2,5 to 5,0 kW	290 x 779 x 209	A++ A+	Dust collection filter	-10 °C in cooling mode -15 °C in heating mode	Aerowings	20 dB(A)	Optional Wi-Fi CZ-TACG1
Floor console 	White	2,5 to 5,0 kW	600 x 750 x 207	A++ A++	nanoeX nanoe X Generator Mark 1	-10 °C in cooling mode -15 °C in heating mode	Double air flow	20 dB(A)	Optional Wi-Fi CZ-TACG1
Low static pressure hide-away 		2,5 to 6,0 kW	200 x 750 x 640	A+ A+	Air filter	-10 °C in cooling mode -15 °C in heating mode	Weekly timer	24 dB(A)	Optional Wi-Fi CZ-TACG1

1) Energy efficiency class in 2,5 kW references. * All data in this chart is applicable in most of the models in each line up, check product specifications to confirm.

Rating conditions: Cooling indoor 27 °C DB / 19 °C WB. Cooling outdoor 35 °C DB / 24 °C WB. Heating indoor 20 °C DB. Heating outdoor 7 °C DB / 6 °C WB. (DB: Dry Bulb; WB: Wet Bulb). Specifications subject to change without notice. For detailed information about ErP / Energy Labelling, please visit our websites www.aircon.panasonic.eu or www.ptc.panasonic.eu.

Feature comparison

Models	Wall-mounted Heatcharge VZ · R32	Wall-mounted Etherea · R32	Wall-mounted TZ super-compact · R32
 Refrigerant R32	✓	✓	✓
 Econavi. Sunlight sensor	✓		
 Inverter+ system	✓	✓	
 Inverter system			✓
 R2 rotary compressor	✓	✓	✓
 nanoe X Generator	✓ nanoe™	✓ Mark 3	✓ Mark 1
 PM2,5 Filter			
 Dust collection filter			
 Antiallergy properties	✓	✓	✓
 Super Quiet ¹⁾	✓	✓ 19 dB(A) for XZ/Z20, XZ/Z25 and XZ/Z35	✓ 20 dB(A) for TZ20, TZ25 and TZ35
 Inside cleaning		✓	
 Mild Dry cooling		✓	
 Aerowings		✓	✓
 Down to -10 °C in cooling only	✓	✓	✓
 Down to -15 °C in heating mode	✓ -35 °C ²⁾	✓ -20 °C	✓
 Summer House	✓		
 R410A/R22 Renewal	✓	✓	✓
 Odour-removing function	✓	✓	✓
 Removable, washable panel	✓	✓	✓
 Powerful mode	✓	✓	✓
 Soft dry operation mode	✓	✓	✓
 Personal air flow creation	✓	✓	✓ For TZ60 and TZ71
 Automatic vertical air flow control			✓ For TZ20, TZ25, TZ35, TZ42 and TZ50
 Manual horizontal air flow control			✓ For TZ20, TZ25, TZ35, TZ42 and TZ50
 Auto mode	✓	✓	✓
 Hot start mode	✓	✓	✓
 Real time clock with dual ON / OFF timer	✓	✓	✓
 Weekly timer			
 LCD infrared remote controller	✓	✓	✓
 Automatic restart	✓	✓	✓
 Long piping	✓ 15 m	✓ 15 m, 30 m (XZ/Z50, Z71)	✓ 15 m, 20 m (TZ50), 30 m (TZ71 and TZ60)
 Top-Panel maintenance access	✓	✓	✓
 Self-diagnosis function	✓	✓	✓
 RAC interface adapter for integration into S-Link	✓	✓	✓
 Wi-Fi control	✓	✓ Built-in	✓ Built-in
Easy control by BMS	✓	✓	✓
Warranty on the compressor	✓	✓	✓

1) At the lowest fan speed. 2) Tested by 3rd party laboratory, SP, according to EN14511:2013 and SP Method 1721, this temperature is not guaranteed by Factory.



Wall-mounted BZ super-compact · R32	Wall-mounted UZ super-compact · R32	Floor console · R32	Low static pressure hide-away · R32
✓	✓	✓	✓
		✓	
✓	✓		✓
✓	✓	✓	✓
		✓ Mark 1	
✓			
	✓		
		✓	
✓ 20 dB(A) for BZ25 and BZ35	✓ 20 dB(A) for UZ25 and UZ35	✓ 20 dB(A) for Z25 and Z35	
✓	✓		
✓	✓	✓	✓
✓	✓	✓	✓
✓	✓	✓	✓
✓	✓	✓	✓
✓	✓	✓	
✓	✓	✓	✓
✓	✓	✓	✓
✓	✓	✓	✓
✓	✓	✓	✓
✓	✓	✓	✓
✓	✓	✓	✓
✓	✓	✓	✓
✓	✓	✓	✓
✓	✓	✓	✓
✓	✓	✓	✓
✓	✓	✓	✓
✓ 15 m, 30 m (BZ60)	✓ 15 m	✓ 20 m, 30 m (Z50)	✓ 20 m, 30 m (Z50 and Z60)
✓	✓	✓	✓
✓	✓	✓	✓
✓	✓	✓	✓
✓	✓	✓	✓
✓	✓	✓	✓
✓	✓	✓	✓

Features explained

Energy saving

R32 Refrigerant R32.
Our heat pumps containing R32 refrigerant show a drastic reduction in the value of Global Warming Potential (GWP). An important step to reduce greenhouse gases. R32 is also a component refrigerant, making it easy to recycle.

38% Econavi Sunlight sensor.
Sunlight Sensor technology can detect and reduce the waste of energy by optimising air conditioner operation according to room conditions. With just one touch of a button, you can save energy.

Inverter+ system.
This classification highlights Panasonic's highest performing systems.

Inverter system.
The Inverter range provides greater efficiency and comfort. Provides more precise temperature control, without highs and lows, and keeps the ambient temperature constant with lower energy consumption and a significant reduction in noise and vibration levels.

R2 Rotary compressor.
Panasonic R2 rotary compressor. Designed to withstand extreme conditions, it delivers high performance and efficiency.

High performance and indoor air quality

nanoe™ X.
Technology with the benefits of hydroxyl radicals has the capacity to inhibit pollutants, viruses, and bacteria to clean and deodorise.

PM2.5 filter.
Particulate matter (PM2.5) can be found suspended in the air, including dust, dirt, smoke and liquid droplets. Sized at 2.5µm, these particles are said to pose health problems as they can easily enter our lungs.

Dust collection filter.
This filter collects and retains particles suspended in the air, resulting in cleaner air in the room.

Antiallergy properties.
System is equipped with antiallergy properties filter.

Inside cleaning.
This function works to dry-off to inside air conditioner with nanoe™ X. It can inhibit certain adhered bacteria, viruses and mould up to 99% efficiency.

Super Quiet.
Thanks to its latest generation compressor and its twin blade fan, our outdoor unit is one of the most silent on the market. The indoor unit emits an almost imperceptible 18 dB(A).

Mild Dry cooling.
Fine control helps prevent a rapid decrease in room humidity while maintaining the set temperature. Maintains an RH* up to 10% higher than cooling operation (*RH: Relative Humidity). Ideal when sleeping with the air conditioner on.

Aerowings.
More comfort with Aerowings. Direct air flow to the ceiling, creating a shower cooling effect with built-in twin flap.

-10 °C Down to -10 °C in cooling only mode.
The air conditioner works in cooling mode when the outdoor temperature of -10 °C.

-15 °C Down to -15 °C in heating mode.
The air conditioner works in heat pump mode when the outdoor temperature is as low as -15 °C.

Summer House.
This innovative function keeps the house at 7/8 °C to avoid freezing pipes during the winter. This function is beneficial for summer or weekend homes.

R22/R410A Renewal.
The Panasonic renewal system allows good quality existing R410A or R22 pipe work to be re-used whilst installing high efficiency R32 systems.

Odour-removing function.
Allows the exchanger to be cleaned, preventing possible odours. While this function is connected, the fan also remains OFF momentarily to avoid unpleasant odours while the exchanger is being cleaned.

Removable, washable panel.
The front panel is easy to keep clean. It can be removed quickly in one single step and can be washed in water. A clean front panel ensures smoother, more efficient operation, which can save energy.

Powerful mode.
The rapid and effective powerful mode is ideal for when you come home on the hottest or coldest days. It works at maximum power to reach the desired temperature in just 15 minutes.

Soft Dry operation mode.
The soft dry mode eliminates excess moisture with a soft breeze and provides a sense of wellbeing without much change in temperature.

Personal air flow creation.
Permits the air direction to be adjusted vertically and horizontally. This feature can be conveniently selected by remote controller.

Automatic vertical air flow control.
The flap swings up and down automatically. The flow can also be set at a fixed angle with the remote controller.

Manual horizontal air flow control.

Auto mode.
Automatically switches the current operation mode to heating or cooling mode necessary to keep the temperature at a constantly comfortable level based on the temperature of the room. In case of multi split installation the function is limited to first unit working and logic of switching is different considering also the outdoor temperature.

Hot Start mode.
At the start of heating cycle and after defrost cycle, the indoor fan will start up once the indoor heat exchanger is warm.

Real time clock with dual ON / OFF timer.
This feature enables you to preset two different sets of start/stop operation timer (hour and minute) within a 24-hour time frame.

Weekly timer.
Allow to fix per each day of the week up to 6 operations per day.

LCD infrared remote controller.

Automatic restart.
This function permits automatic restarting if safe mode operation has stopped for some unusual reason, such as after a power cut. As soon as the power is back, the unit restarts with the parameters selected before it stopped.

Long piping.
Indicates the maximum length of pipe between the outdoor unit and the indoor unit(s). The distances permitted, demonstrate the installations possible.

Top-panel maintenance access.
Maintenance of an outdoor unit used to be quite a tedious task. Now, with the possibility of removing the top cover, maintenance is quick and easy.

Self-diagnosis function.
With this function the unit carries out a process self-diagnosis when a particular function does not work correctly. This allows faster servicing.

High connectivity

RAC interface adapter for integration into S-Link.
CZ-CNT port integration to PACi and ECOi. Domestic integration to S-Link. Can connect ranges to S-Link. Full control is now possible.











Wi-Fi control.
A next generation system providing user-friendly control of air conditioning or heat pump units from everywhere, using a simple Android™ or iOS smartphone or tablet via Wi-Fi.

Easy control by BMS.
The communication port can be integrated into the indoor unit and provides easy connection to, and control of, your Panasonic heat pump to your home or building management system.





5 Years warranty.
Panasonic guarantees the compressors in the entire range for five years.

Accessories and control

Connectivity





 <p>Wi-Fi adapter for smart control via Panasonic Comfort Cloud App.</p> <p>-----</p> <p>CZ-TACG1</p>	 <p>Interface adapter for integration into S-Link, plus external input and alarm/status output.</p> <p>-----</p> <p>CZ-CAPRA1</p>	 <p>KNX interface. Can be used with all models which have a CN-CNT connector (Intesis).</p> <p>-----</p> <p>PAW-AC-KNX-1i</p>	 <p>Modbus interface. Can be used with all models which have a CN-CNT connector (Intesis).</p> <p>-----</p> <p>PAW-AC-MBS-1</p>
 <p>BACnet interface. Can be used with all models which have a CN-CNT connector (Intesis).</p> <p>-----</p> <p>PAW-AC-BAC-1</p>	 <p>NEW KNX interface. Can be used with all models which have a CN-CNT connector (Airzone).</p> <p>-----</p> <p>PAW-AZAC-KNX-1</p>	 <p>NEW Modbus interface. Can be used with all models which have a CN-CNT connector (Airzone).</p> <p>-----</p> <p>PAW-AZAC-MBS-1</p>	 <p>NEW BACnet interface. Can be used with all models which have a CN-CNT connector (Airzone).</p> <p>-----</p> <p>PAW-AZAC-BAC-1</p>
 <p>This interface can be used with all models which have a CN-RMT connector.</p> <p>-----</p> <p>PAW-AC-DIO</p>	 <p>Heating only PCB for Etherea and low static pressure hide-away.</p> <p>-----</p> <p>PAW-AC-HEAT-1</p>	 <p>Control of the Etherea and Heatcharge by SMS (need additional SIM card).</p> <p>-----</p> <p>PAW-SMSCONTROL</p>	

Individual controls

 <p>Wired remote controller for wall-mounted and floor console.</p> <p>-----</p> <p>CZ-RD517C</p>	 <p>Infrared remote controller Sky Remote. 2 m cable length of infrared receiver for hide-away.</p> <p>-----</p> <p>CZ-RL511D</p>	 <p>NEW CONEX wired remote controller (non-wireless) for 4 way 60x60 cassette - PY3, white.</p> <p>* Available in Autumn 2023.</p> <p>-----</p> <p>CZ-RTC6W</p>	 <p>CONEX wired remote controller (non-wireless) for 4 way 60x60 cassette - PY3, black.</p> <p>-----</p> <p>CZ-RTC6</p>
---	---	--	---

Panel

Pipe reducer

 <p>Panel for 4 way 60x60 cassette - PY3.</p> <p>-----</p> <p>CZ-KPY4</p>	 <p>Reduces the connection size on the indoor unit from 1/2" to 3/8".</p> <p>-----</p> <p>CZ-MA1PA</p>	 <p>Increases the connection size on the outdoor unit from 3/8" to 1/2".</p> <p>-----</p> <p>CZ-MA2PA</p>	 <p>Reduces the connection size on the indoor unit from 5/8" to 1/2".</p> <p>-----</p> <p>CZ-MA3PA</p>
---	---	---	---

PACi



Panasonic Commercial air to air

Panasonic has developed an impressive range of highly efficient Commercial Air Conditioners. This range confirms our commitment to the environment, with our highly efficient Inverter compressor technology to optimise performance.

Highlighted features	→ 156
Product quality and safety	→ 158
PACi NX Series	→ 160
PACi NX Series 4	→ 162
CONEX. Devices and apps	→ 164
Commercial Wi-Fi Adaptor	→ 165
Bringing nature's balance indoors	→ 166
PACi NX 4 way 90x90 cassette - PU3	→ 168
PACi NX adaptive ducted unit - PF3	→ 170
PACi NX wall-mounted, 4 way 60x60 cassette and ceiling	→ 172
Solutions for server rooms applications	→ 174

Commercial units range	→ 176
Wall-mounted Professional Inverter -25 °C	→ 178
Elite - Standard wall-mounted · R32	→ 180
Elite - Standard 4 way 60x60 cassette · R32	→ 184
Elite - Standard 4 way 90x90 cassette · R32	→ 186
Elite - Standard ceiling · R32	→ 190
Elite - Standard adaptive ducted unit · R32	→ 194
High static pressure hide-away 20,0-25,0 kW · R32	→ 198

Commercial PACi NX Multi	→ 200
Commercial twin, triple and double-twin systems · R32	→ 202

Hydronic PACi	
PRO-HT Tank Series for PACi	→ 206
Panasonic PACi with Water Heat Exchanger	→ 210

R22 Renewal. Fast, easy to install and cost effective	→ 214
---	-------

Accessories and control	→ 218
-------------------------	-------

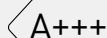
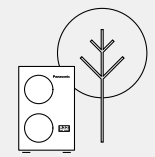

Highlighted features

PACi: Commercial air to air. The compact and high efficiency solution for shops, restaurants, offices or residential applications.

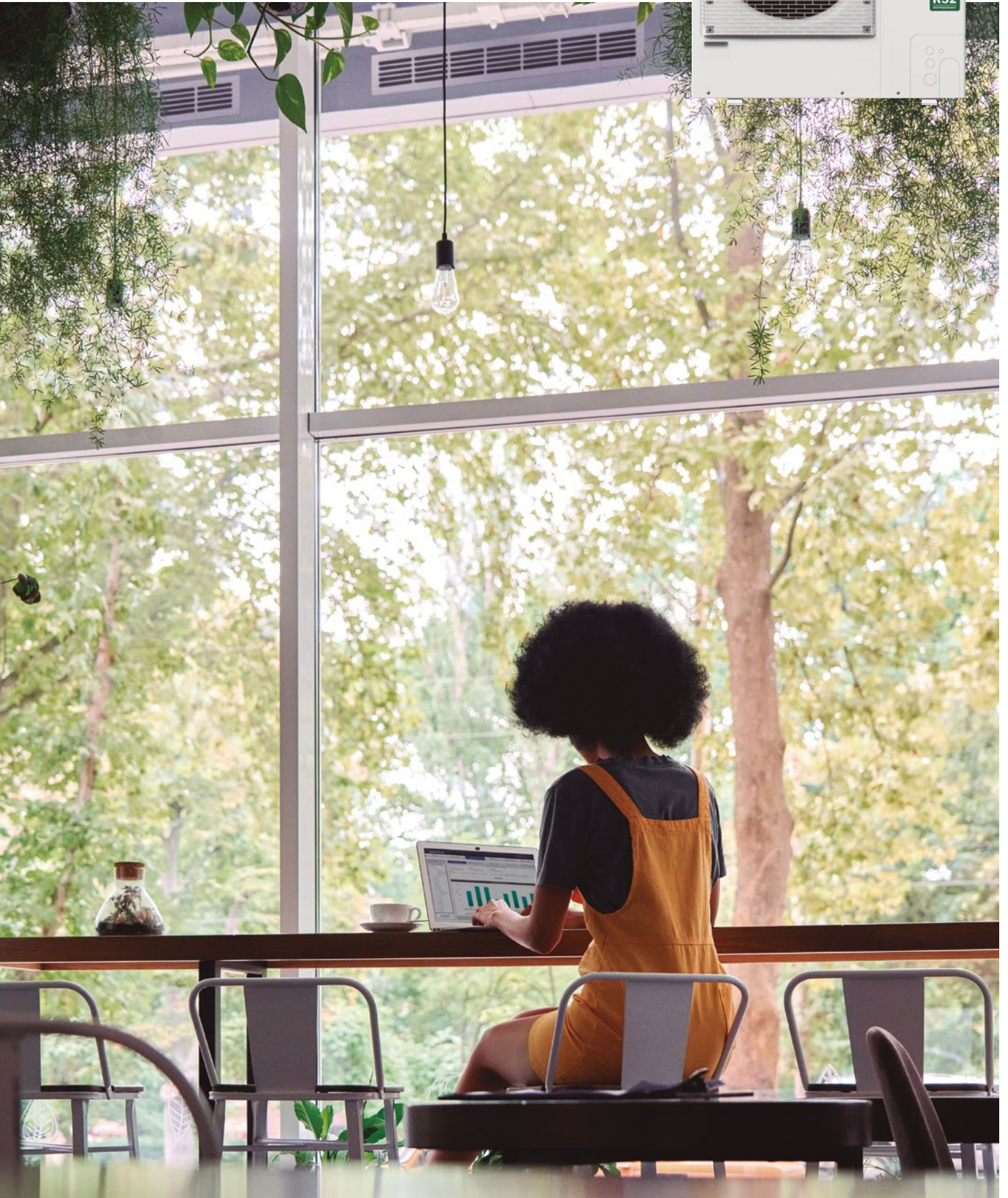

Great savings and improved comfort. Panasonic has developed an impressive range of highly efficient Commercial air conditioners, with our highly efficient Inverter compressor technology to optimise performance.

A wide range for industry, office or residential application. With configuration from 1:1 to 4:1, Panasonic can offer the most comfortable climate with solutions designed for every environment.

The diverse array of connectivity and control systems allows you to manage your units whether locally or remotely. Receive real-time status updates and maintenance alerts, while optimising costs and energy usage.

Energy saving



R32 refrigerant.

Our heat pumps containing R32 refrigerant show a drastic reduction in the value of Global Warming Potential (GWP). An important step to reduce greenhouse gases. R32 is also a component refrigerant, making it easy to recycle.



Exceptional seasonal cooling efficiency based on the ErP regulation.

9,6 SEER

Higher SEER ratings mean greater efficiency and year-round cooling savings!



Exceptional seasonal heating efficiency based on the ErP regulation.

5,1 SCOP

Higher SCOP ratings mean greater efficiency and year-round heating savings!



28%
ECONAVI

Econavi.

Intelligent human activity sensor and sunlight sensor technologies that can detect and reduce the waste of energy by optimising air conditioner operation according to room conditions. With just one touch of a button, you can save energy.



INVERTER+

Inverter Plus system.

Inverter Plus system classification highlights Panasonic's highest performing systems.



INVERTER

Inverter.

The Inverter range provides greater efficiency and comfort. Provides more precise temperature control, without highs and lows, and keeps the ambient temperature constant with lower energy consumption and a significant reduction in noise and vibration levels.



HIGH EFFICIENCY
COMPRESSOR

High efficiency compressor.

Panasonic Big PACi has compressors that operate with a wider Hz range realize a more efficient operation throughout the year.



R2 ROTARY
COMPRESSOR

Panasonic R2 rotary compressor.

Designed to withstand extreme conditions, it delivers high performance and efficiency.



A++

Better efficiency and value for domestic hot water.

PRO-HT tank energy efficiency class up to A+ in a scale from A+ to F.



A+++

Better efficiency and value for low temperature applications.

On an energy efficiency scale from D to A+++ , both the PACi Water Heat Exchanger and the PRO-HT provide A++ rated heating.

High performance and indoor air quality



COOLING MODE

Down to -20 °C in cooling mode.

The air conditioner works in cooling mode when the outdoor temperature of -20 °C.



HEATING MODE

Down to -20 °C in heating mode.

The air conditioner works in heat pump mode when the outdoor temperature is as low as -20 °C.



nanoe™ X

nanoe™ X.

Technology with the benefits of hydroxyl radicals has the capacity to inhibit pollutants, viruses, and bacteria to clean and deodorise.



22 dB(A)

Super Quiet.

With Super Quiet technology our devices are quieter than a library (30 dB(A)).



DC FAN

DC fan.

Safe and precise.



FILTER INCLUDED

Filter included.

Hide-away with filter included.



BLUEFIN

Bluefin.

Panasonic Big PACi has extended the life of its condensers with an original anti-rust coating.



LARGE FAN

Large fan.

Panasonic Big PACi large fan provides larger air flow rate and very quiet operation at low speed.



AEROWINGS

More comfort with Aerowings.

Wall-mounted YKEA direct air flow to the ceiling, creating a shower cooling effect with built-in twin flap.



DHW

DHW.

With PRO-HT Tank you can also heat your domestic hot water at a very low cost with the optional hot water cylinder.



65°C
OUTPUT WATER
HIGH
TEMPERATURE

High temperature.

With PRO-HT Tank, maximum water outlet temperature up to 65 °C.



OPERATION RANGE

-20 °C operating range.

The PRO-HT Tanks work with an outdoor temperature is as low as -20 °C.



COOLING MODE

Up to 46 °C in cooling mode.

PACi with Water Heat Exchanger system works in cooling mode at outdoor temperature up to 46 °C.



R22
R410A
R22 / R410A
RENEWAL

R410A/R22 renewal.

The Panasonic renewal system allows good quality existing R410A or R22 pipe work to be re-used whilst installing high efficiency R32 systems.



5 YEARS
COMPRESSOR
WARRANTY

5 Years compressor warranty.

We guarantee the outdoor unit compressors in the entire range for five years.

High connectivity



PANASONIC
AC SMART CLOUD

Panasonic AC Smart Cloud.

The AC Smart Cloud from Panasonic allows you to have complete control of all your installations. In a simple click, receive status updates from all your units in real-time, preventing breakdowns and optimising costs.



INTERNET CONTROL

Internet control.

A next generation system providing user-friendly remote control of air conditioning or heat pump units from everywhere, using a simple Android™ or iOS smartphone, tablet or PC via the internet.



BMS
CONNECTIVITY

BMS connectivity.

The communication port can be integrated into the indoor unit and provides easy connection to, and control of, your Panasonic heat pump to your home or building management system.



INTEGRATION
TO S-LINK

Domestic integration to S-Link - CZ-CAPRA1.

Can connect RAC range to S-Link. Full control is now possible.



ADVANCED
CONTROL

Advanced control.

A touch screen remote controller is included as a standard. Clean design, easy operation and quick access to all menus.

Product quality and safety

All Panasonic air conditioners undergo strict quality and safety tests before sale. This rigorous process includes obtaining all necessary safety approvals, to ensure that all air conditioners we sell are not only built to the highest market standards, but are also completely safe.



Professional air conditioners with R32 refrigerant.

Panasonic recommends R32, with lower Global Warming Potential (GWP). Compared to R22 and R410A, R32 has a low potential impact on global warming.

Panasonic takes action in helping to protect the environment. In line with the European countries participating in the Montreal Protocol, protecting the ozone layer and preventing global warming, Panasonic is leading the switch to R32.

1 Installation innovation

- Extremely easy to install, practically the same as R410A
- Single substance refrigerant, which makes it easier to recycle and reuse

2 Environmental innovation

- Zero impact on the ozone layer
- 75% less impact on global warming

3 Economic and energy consumption innovation

- Lower cost and greater savings
- Higher energy efficiency than R410A

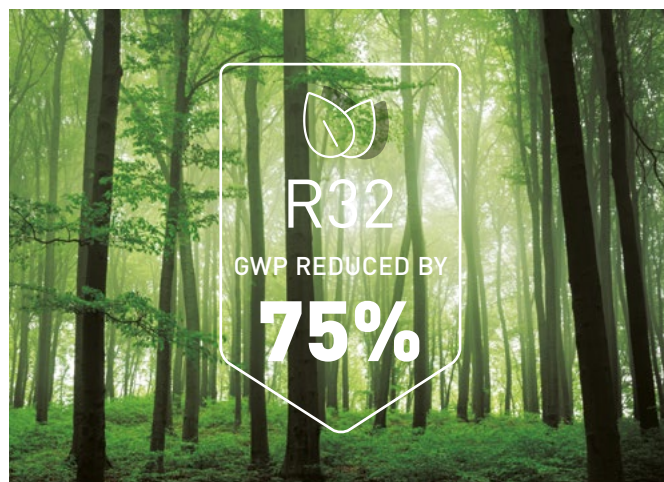

PACi NX Elite: Top-tier commercial air conditioning

Outstanding performance at extreme ambient temperatures with very high energy efficiency both in heating and cooling. Fans, fan motors, compressors and heat exchangers engineered for maximum savings result in higher seasonal efficiencies, which ranks as one of the best in the industry, ensuring reduced CO₂ emissions, energy consumption and operating costs.

From 3,6 to 14,0 kW.

- Meeting all necessary approvals to ensure quality and safety
- Top class SEER: 8,9 A+++ / SCOP: 5,1 A+++ at 3,6 kW (in 90x90 cassette)

- Cooling operation is possible with outdoor temperature as high as 48 °C (for 7,1 kW and higher capacities)
- Precise control with DC Inverter technology for even more energy saving
- Cooling operation at -20 °C (10,0 kW to 14,0 kW with 30 m maximum pipe length)
- Heating operation at ambient temperature as low as -20 °C
- Compact outdoor units
- Auto restart after power outage
- Twin, triple and double-twin connections

PACi NX Standard: For economy and value

With high quality design and engineering, the PACi NX Standard are the perfect solutions for projects which demand quality on a limited budget. In addition, compact and lightweight design makes them ideal for installations with limited space including small commercial and residential applications. The slim and lightweight outdoor unit design enables installation even in very challenging locations.

From 2,5 to 14,0 kW.

- Extended range of outdoor units starting from 2,5 kW

- Great balance of system cost and performance
- Top class SEER / SCOP in the standard Inverter category SEER: 8,1 A++ / SCOP: 4,8 A++ at 3,6 kW (in 90x90 cassette)
- Variety of individual and central controllers which provides full flexibility
- Compact outdoor units, small footprint and lightweight
- Twin connection possible from 10,0 to 14,0 kW
- Cooling operation down to -10 °C and heating operation down to -15 °C

Big PACi Elite R32

20,0 – 25,0 kW is ideally suited for small and mid retail applications.

In addition to its lightweight, split-able, compact body, the hide-away unit enables easy installation and pipe work within a narrow void.

Panasonic Big PACi: Environmental friendly, strong and flexible.

- High efficiency with Panasonic compressor as the driving force

- Compact and light indoor body
- Easy pipe work with split-able hide-away indoor design
- Separable indoor unit allows for flexible installation to fit in narrow void
- Water heat exchanger and AHU connection compatibility
- Bluefin anti-corrosion coating of the heat exchanger as standard
- Wide range of controls including Cloud Control compatibility

PACi NX Series. The next generation is here

NX Series with R32 refrigerant has been developed to meet the demand of easy refurbishment with 3 wire method.

Integrated with IoT solutions and includes nanoe™ X function as standard.



1 PACi NX Series for absolute ease of refurbishment

This series have been developed with 3 wire power and communication. It makes it simple and easy to replace old systems with 3 wire connections, which is prevalent in many systems.

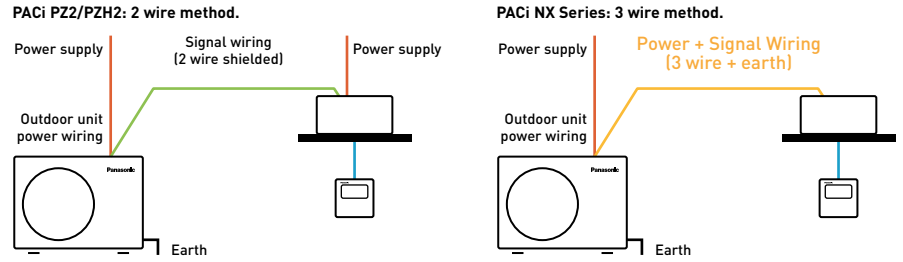

2 CONEX with IoT integration

The wired remote controller series is fully integrated with IoT solutions developed by Panasonic. Detailed operation, maintenance setting and service operation are all possible with smartphone or tablet.

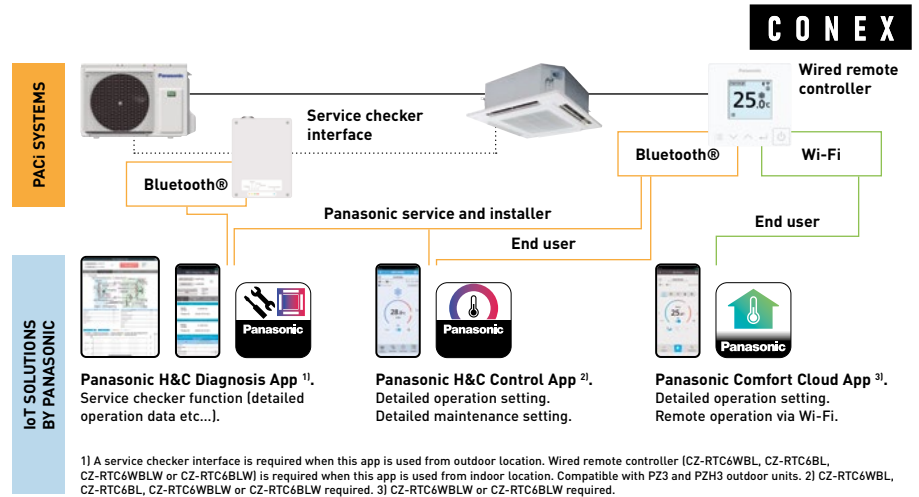

3 Let Panasonic take care of indoor air quality

Thanks to the nanoe™ X properties, several types of pollutants can be inhibited such as certain types of bacteria, viruses, mould, allergens, pollen and certain hazardous substances. This unique technology is equipped to provide better air quality whether residential or commercial.



7 effects of nanoe™ X – Panasonic unique technology.

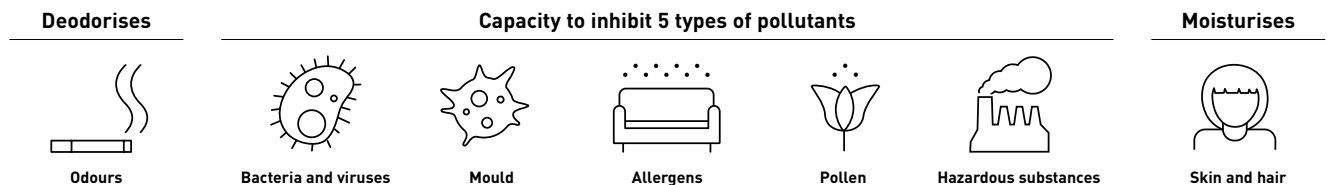

The nanoe™ X performance varies depending on the room size, environment and usage and it may take several hours to reach the full effect. nanoe™ X is not medical device, local regulations on building design and sanitary recommendations must be followed.

➤ REFER TO PAGE 10 FOR MORE DETAILS AND VALIDATION DATA

4 Increasing the efficiency

The PACi NX Series have improved seasonal efficiencies in both heating and cooling versus the previous generation.

Energy class ¹⁾ and seasonal efficiency value ($\eta_{s,c} / \eta_{s,h}$) ²⁾																				
kW	Wall-mounted - PK3				4 way cassette - PY3				4 way cassette - PU3				Ceiling - PT3				Adaptive ducted - PF3			
	Elite		Standard		Elite		Standard		Elite		Standard		Elite		Standard		Elite		Standard	
2,5					A++ A++															
3,6	A++	A++	A++	A+	A++	A++	A++	A+	A+++	A+++	A++	A++	A++	A++	A++	A+	A++	A+	A+	A+
5,0	A++	A++	A++	A+	A++	A++	A++	A+	A++	A++	A++	A++	A++	A++	A++	A+	A++	A+	A++	A+
6,0	A++	A++	A++	A++	A++	A+	A++	A+	A++	A++	A++	A++	A++	A++	A++	A++	A++	A++	A++	A++
7,1	A++	A++	A+	A+					A++	A++	A++	A++	A++	A++	A+	A+	A++	A++	A++	A+
10,0	A++	A+	A++	A					A++	A++	A++	A+	A++	A++	A++	A+	A++	A+	A++	A
12,5									304,3%	186,0%	267,0%	157,0%	278,4%	181,0%	241,7%	147,4%	281,7%	170,0%	257,4%	142,6%
14,0									286,6%	181,2%	257,0%	152,2%	263,3%	178,0%	228,8%	145,3%	275,9%	171,0%	252,2%	140,6%

1) Energy label scale from A+++ to D for models below 12,0 kW (EU regulation 626/2011). 2) $\eta_{s,c} / \eta_{s,h}$ values for models above 12,0 kW (EN 14825).

New PACi NX Elite Series 4



The compact chassis newly designed with one fan up to 14,0 kW, will fit in limited installation space

The slim and lightweight outdoor units can be installed in a number of compact situations. With the unit weighting only 66 kg*, it is easy to carry and easy to install.

* For model 7,1 kW.

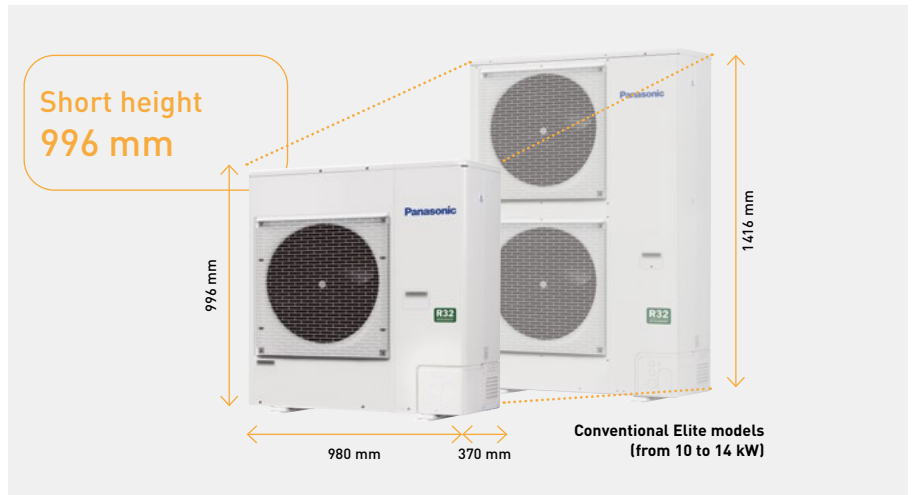

Highly efficient performance in a compact body

One fan outdoor units keep the excellent seasonal performance optimising three layers heat exchanger. As a result, PZH4 series provide the equivalent high seasonal performance to conventional 2 fan models.

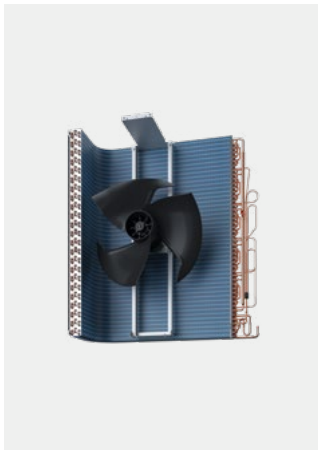

New Elite PZH4 Series.

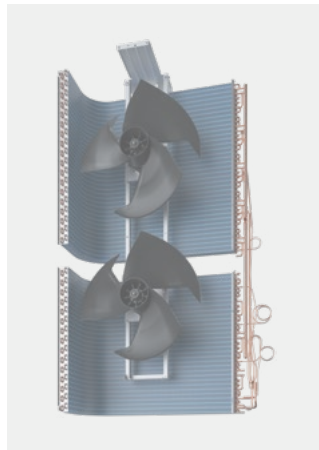

Conventional model with two fans.

PZH series seasonal performance.

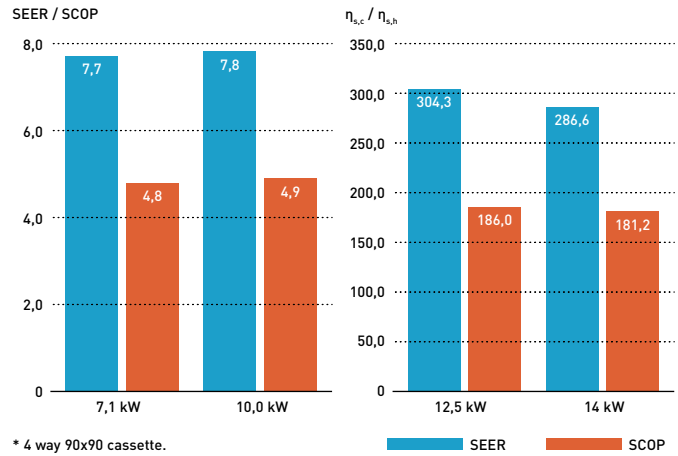

* 4 way 90x90 cassette.

Extended operation range up to 52 °C in cooling and down to -20 °C in heating

Upgraded PACi NX Elite Series are capable of working even in the challenging ambient conditions. Cooling operation is possible when outdoor temperature is as low as -20 °C* or as high as 52 °C. Heating operation can also be utilized at outdoor temperatures down to -20 °C when outdoor temperature is as low as -20 °C.

* For models 10,0 – 14,0 kW with pipe length up to 30 m.

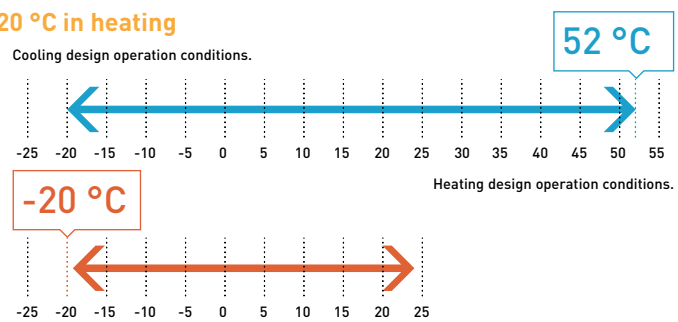

Long piping allowance maximum 100 m*

Increased piping length gives great design flexibility to adapt various building types and sizes. Piping length: 100 m (10,0 to 14,0 kW), 60 m (7,1 kW)

* For models 10,0 – 14,0 kW.

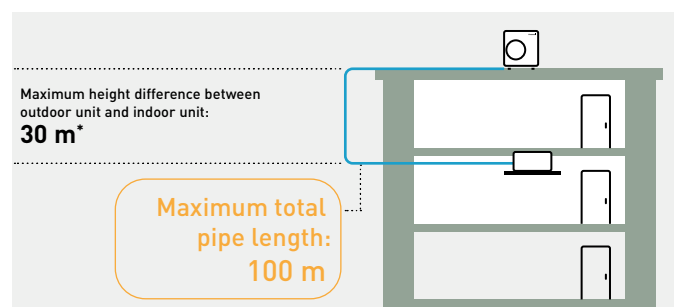

* 15 m if the outdoor unit is below the indoor unit.

CONEX. Devices and apps

CONEX provides comfort and control for varying user needs. Accessible, flexible and scalable with different controllers and apps. Perfectly meeting requirements of modern controls for end user, installer and service. With nanoe™ X function, technology with the benefits of hydroxyl radicals.

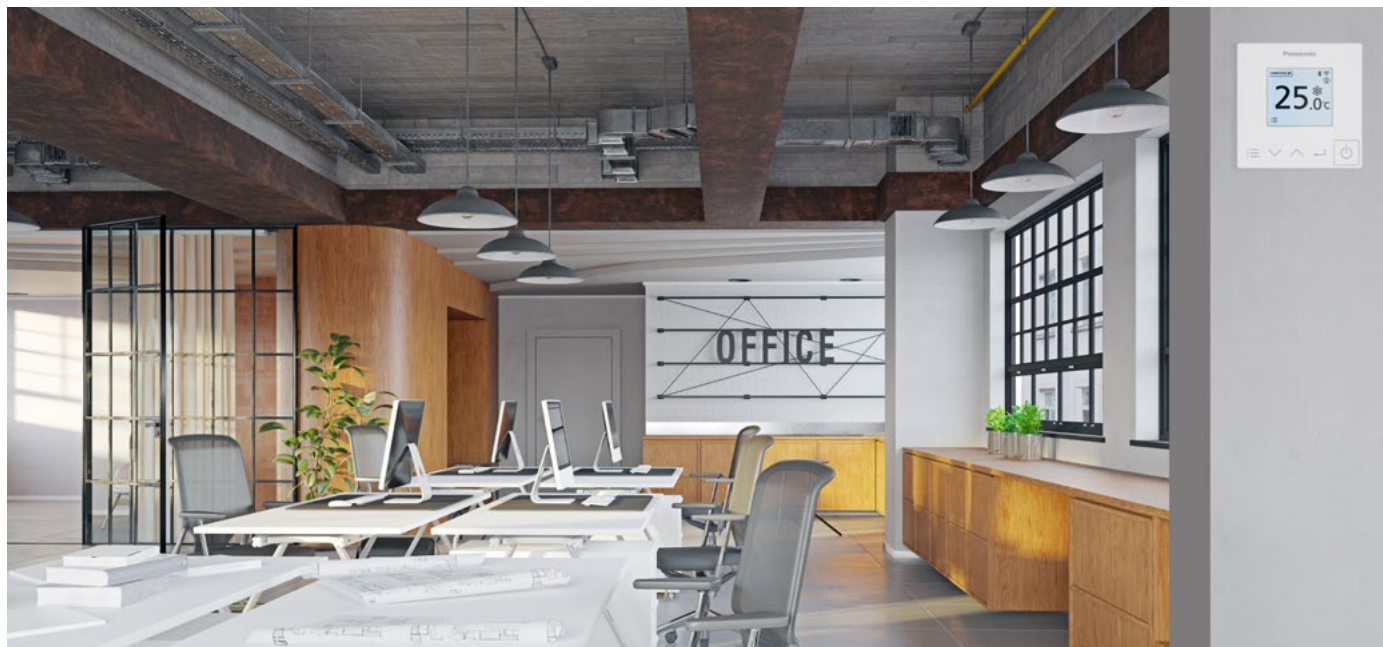
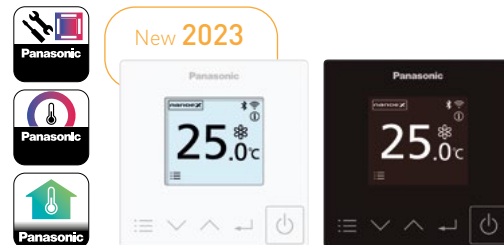

- 1 Intuitive control with stylish design**
- Simple operation at a glance
 - Clean face with full flat and LCD display
 - Compact body, only 86x86 mm

- 2 Control comfort with your smartphone**
- Flexible control options with IoT integration
 - Panasonic H&C Control App for daily remote control operation
 - Panasonic Comfort Cloud App for remote operation 24/7/365

- 3 Easy maintenance with service support app**
- Quick and easy app set-up for system setting
 - Panasonic H&C Diagnosis App enables the user to obtain detailed system operation data
- * The use of apps depends on the remote controller model.

CONEX with IoT integration



The wired remote controller series is fully integrated with IoT solutions developed by Panasonic. Detailed operation, maintenance setting and service operation are all possible with smartphone or tablet.

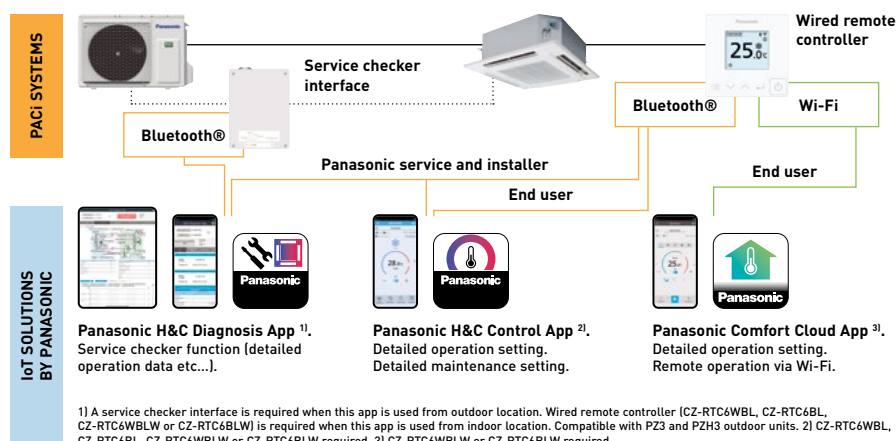

White model ¹⁾	CZ-RTC6W	CZ-RTC6WBL	CZ-RTC6WBLW
Black model	CZ-RTC6	CZ-RTC6BL	CZ-RTC6BLW
Wired connection compatible with	PACi, PACi NX, ECOi, GHP	PACi, PACi NX, ECOi, GHP	PACi NX only
Wireless functions	No wireless capability	Bluetooth®	Bluetooth® + Wi-Fi
App compatibility			
Panasonic Comfort Cloud App	—	—	✓
Panasonic H&C Control App	—	✓ PACi, PACi NX, ECOi, GHP	✓ PACi NX only
Panasonic H&C Diagnosis App ²⁾	—	✓ PACi NX only ³⁾	✓ PACi NX only ³⁾
Outdoor unit settings (remote controller connected to indoor unit)	✓ PACi NX only ³⁾	✓ PACi NX only ³⁾	✓ PACi NX only ³⁾

1) Available in Autumn 2023. 2) Compatible with U-71/100/125/140PZH3E5/8 and U-100/125/140PZ3E5/8. 3) When connected to PACi NX indoor and outdoor unit combination.

Commercial Wi-Fi Adaptor

Panasonic CZ-CAPWFC1 interface adaptor, allows connection of one or a group of indoor units to Panasonic Comfort Cloud App, which provides control, monitoring, scheduling and error alerts.



Advanced smartphone control

Control PACi, ECOi and ECO G indoor units with your smartphone from wherever and whenever you are, by using Panasonic Comfort Cloud App and Commercial Wi-Fi Adaptor. This scalable solution is ideal for one system, one site or multiple locations. Coupling the adaptor with the already feature rich systems, makes it an ideal solution for residential and commercial applications.

1 From 1 to 200 units
User can control up to 10 different sites, with up to 20 units / groups per site. Additionally, one adaptor can be connected to 1 indoor or to a group of up to 8 indoors.

2 Voice control compatible
When registering the unit to Panasonic Comfort Cloud App makes it compatible with most popular voice assistants.

3 Multi user
The Panasonic Comfort Cloud App allows multi-user access control. Restrict user access to specific units.

4 Easy scheduling
Complex weekly scheduling made simple. Not only for one unit, but across multiple sites and from a smartphone.

5 Energy monitor
See the estimated power consumption and compare with other periods, to see how energy consumption can be reduced even more. Check list of units that provides consumption*.

6 Error codes
Error code notification through the App, provides early notification and allows for faster repair.

* Function available depending on the model.

Connection Diagram

Commercial Wi-Fi Adaptor wiring length is 1,9 m and connects to indoor unit via T10 connector and R1/R2 terminal connectors.

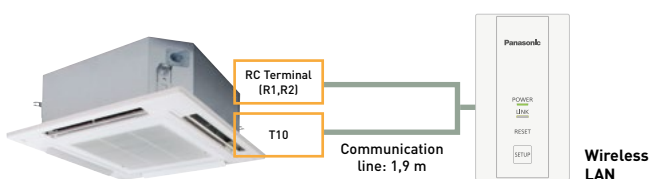

Input Voltage	DC 12 V (supplied from T10 connector)
Power Consumption	Maximum 2,4 W
Size (HxWxD)	120 x 70 x 25 mm
Weight	190 g (including communications lines)
Interface	1 x Wireless LAN
Wireless LAN Standard	IEEE 802,11 b/g/n
Frequency Range	2,4 GHz band
Operating range	0 ~ 55 °C, 20 ~ 80 RH%
Connectable indoor unit	1 unit
Length of communication line	1,9 m (included)

Download free app: Panasonic Comfort Cloud App.

Other hardware requirements: Router and Internet (purchase and subscribe separately).

Panasonic Cloud Server is designed, operated and managed by Panasonic.

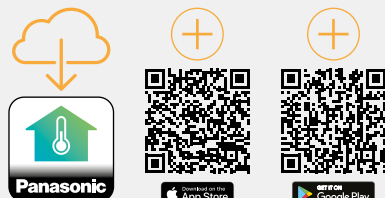

Bringing nature's balance indoors



nanoe™ X, technology with the benefits of hydroxyl radicals.

Abundant in nature, hydroxyl radicals (also known as OH radicals) have the capacity to inhibit pollutants, viruses, and bacteria to clean and deodorise. nanoe™ X technology can bring these incredible benefits indoors so that hard surfaces, soft furnishings, and the indoor environment can be a cleaner and more pleasant place to be, whether at home, work, or visiting hotels, shops and restaurants etc.



Panasonic's nanoe™ X technology takes this a step further and brings nature's detergent – hydroxyl radicals – indoors to help create an ideal environment

Thanks to the nanoe™ X properties, several types of pollutants can be inhibited such as certain types of bacteria, viruses, mould, allergens, pollen and certain hazardous substances.

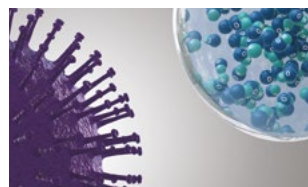

1 | nanoe™ X reliably reaches pollutants.



2 | Hydroxyl radicals denature pollutants' proteins.

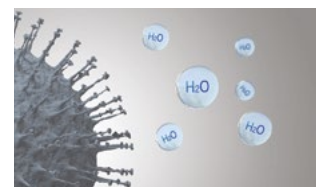

3 | Pollutants activity is inhibited.

What is unique about nanoe™ X?

Effective on fabrics and surfaces.

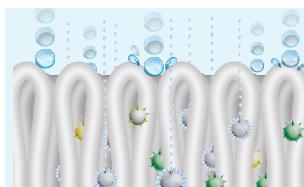

1 | At one billionth of a metre, nanoe™ X is much smaller than steam and can deeply penetrate cloth fabrics to deodorise.

Longer lifespan.



2 | Contained in tiny water particles, nanoe™ X has a long lifespan, which is about 600 seconds, to spread easily around the room.

Huge quantity.



3 | nanoe™ X Generator Mark 2 produces 9,6 trillion hydroxyl radicals per second. Greater amounts of hydroxyl radicals contained in nanoe™ X lead to higher performance on inhibition of pollutants.

Maintenance-free.

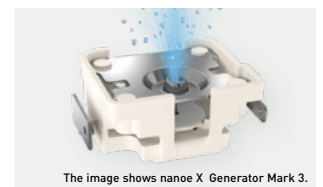

The image shows nanoe™ X Generator Mark 3.

4 | No service and maintenance required. nanoe™ X is a filter free solution that does not require maintenance, as its atomisation electrode is enveloped with water during its generation process and it is made with Titanium.

7 effects of nanoe™ X – Panasonic unique technology

Deodorises

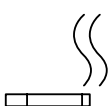

Odours

Capacity to inhibit 5 types of pollutants

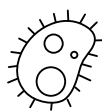

Bacteria and viruses

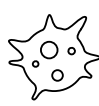

Mould



Allergens



Pollen



Hazardous substances



Skin and hair

* Refer to <https://aircon.panasonic.eu> for more details and validation data.

nanoe™ X, internationally-validated technology in testing facilities.

The effectiveness of nanoe™ X technology has been tested by 3rd party laboratories in Germany, France, Denmark, Japan and China.

The nanoe™ X performance varies depending on the room size, environment and usage and it may take several hours to reach the full effect. nanoe™ X is not medical device, local regulations on building design and sanitary recommendations must be followed. Test results conducted under controlled laboratory conditions. Performance of nanoe™ X might differ in real life environment.

	Tested contents	Generator	Result	Capacity	Time	Testing organisation	Report No.	
Airborne	Virus	Influenza (H1N1)	Mark 2	98,3% inhibited	30 m³	1,5 h	China Electronic Product Reliability and Environmental Testing Research Institute	J2003WT8888-00889
		Bacteriophage ΦX174	Mark 1	99,7% inhibited	Approx. 25 m³	6 h	Kitasato Research Center for Environmental Science	24_0300_1
	Bacteria	Staphylococcus aureus	Mark 1	99,9% inhibited	Approx. 25 m³	4 h	Kitasato Research Center for Environmental Science	2016_0279
Adhering	Virus	SARS-CoV-2	Mark 1	91,4% inhibited	6,7 m³	8 h	Texcell (France)	1140-01 C3
		SARS-CoV-2	Mark 1	99,9% inhibited	45 L	2 h	Texcell (France)	1140-01 A1
		Bacteriophage ΦX174	Mark 1	99,8% inhibited	Approx. 25 m³	8 h	Japan Food Research Laboratories	13001265005-01
		Xenotropic murine leukemia virus	Mark 1	99,999% inhibited	45 L	6 h	Charles River Biopharmaceutical Services GmbH	—
		Coxsackie virus (CA16)	Mark 2	99,9%inhibited	30 m³	4 h	China Electronic Product Reliability and Environmental Testing Research Institute	J2002WT8888-00439
	Bacteria	Staphylococcus aureus	Mark 1	99,9% inhibited	20 m³	8 h	Danish Technological Institute	868988
	Pollen	Cedar	Mark 2	99%inhibited	23 m³	12 h	Panasonic Product Analysis Center	L19YA009
		Ambrosia pollen	Mark 1	99,4% inhibited	20 m³	8 h	Danish Technological Institute 868988	868988
	Odours	Cigarette smoke odour	Mark 1	Odour intensity reduced by 2,4 levels	Approx. 23 m³	0,2 h	Panasonic Product Analysis Center	4AA33-160615-N04

First nanoe™ device was developed by Panasonic in 2003

Generator: nanoe™	Generator: nanoe™ X		
2003	Mark 1 - 2016	Mark 2 - 2019	NEW Mark 3 - 2022
480 billion hydroxyl radicals/sec	4,8 trillion hydroxyl radicals/sec	9,6 trillion hydroxyl radicals/sec	48 trillion hydroxyl radicals/sec

Ion particle structure

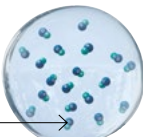

Hydroxyl radicals

10x times

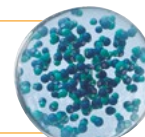

20x times

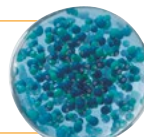

100x times

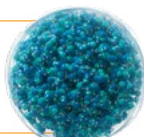

nanoe™ X: improving protection 24/7



Acts to clean your air, so that the indoor environment can be a cleaner and more pleasant place to be all day long. nanoe™ X works together with heating or cooling function when you are at home and can work independently when you are away. Give the air conditioning the strength to increase the protection at home with nanoe™ X technology and convenient control via the Panasonic Comfort Cloud App.



Cleans the air when you are away.

Leave the nanoe™ mode ON to inhibit certain pollutants and deodorise before you return home.

Improves your environment when you are at home.

Enjoy a cleaner, comfortable space with loved ones.

Panasonic Heating & Cooling Solutions is incorporating nanoe™ technology in a wide range of equipment

- 

Wall-mounted.
Built-in nanoe X Generator Mark 2.



Ceiling.
Built-in nanoe X Generator Mark 2.
- 

4 Way 60x60 cassette.
Built-in nanoe X Generator Mark 2.



Adaptive ducted unit.
Built-in nanoe X Generator Mark 2.
- 

4 Way 90x90 cassette.
Built-in nanoe X Generator Mark 1.



Ceiling mounted air-e nanoe X Generator.
Built-in nanoe X Generator Mark 1.

PACi NX 4 way 90x90 cassette - PU3

These cassettes offer upgraded nanoe™ X and Econavi technologies to make the room air more comfortable and healthy and to increase the energy efficiency.





+ SEE PRODUCT SPECIFICATIONS

1 Improved indoor air quality with nanoe™ X and fresh air intake

- nanoe™ X technology equipped as standard for improved indoor air quality
- Internal cleaning function for the unit with nanoe™ X
- High external fresh air intake volume with optional kit (CZ-FDU3 + CZ-ATU2)

2 Superior energy efficiency and comfort

- High seasonal efficiency both in heating and cooling, maximum SEER: 8,9 A+++ / SCOP: 5,1 A+++*
- Econavi: Intelligent sensors to increase energy savings and comfort
- Super quiet operation down to 27 dB(A)

* For 3,6 kW model.

3 Easy installation

- Light weight, easy piping and integrated drain pump for quick installation
- Wired remote controller CZ-RTC6WBL and CZ-RTC6BL allows easy system setting via Bluetooth®

Always fresh and clean air with nanoe™ X

The 4 way 90x90 cassette with nanoe™ X, when tested, has shown to inhibit hazardous substances by 92%, when compared to natural reduction*. In addition to the 7 effects of nanoe™ X, the indoor unit can also be cleaned with a short operation of nanoe™ X + dry mode.

* Controllers (CZ-RTC5B, CZ-RTC6W/BL/BLW or CZ-RTC6/BL/BLW) are required.

After cooling / drying operation, the inside of the indoor unit is automatically dried and nanoe™ X is activated to suppress mould growth.

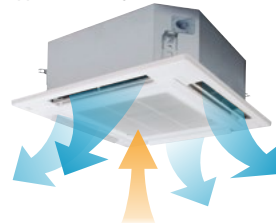

Operates the fan to discharge internal humidity.

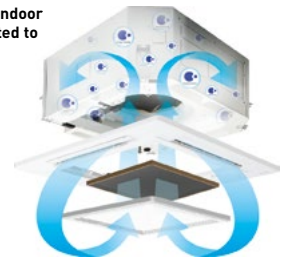

Operate the fan to circulate nanoe™ X internally.

nanoe™ X effect against odour proven in large space

92% of hexadecane ¹⁾ is inhibited after 8-hours exposure in room side 267 m².

Hexadecane inhabitation ratio [%].

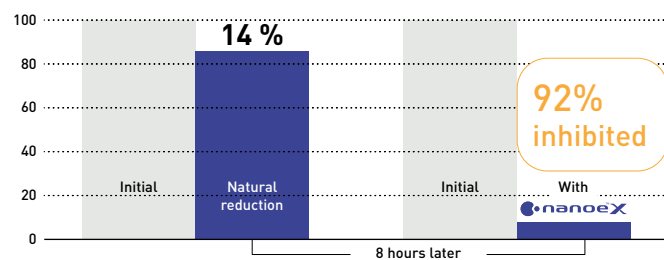

Test ambient.

3rd party certification organization SIRIM ²⁾ conducted the performance experiment of 4 way cassette equipped with nanoe X Generator Mark 1 device in inhibiting hexadecane, a chemical contaminant.

¹⁾ Hexadecane is a hazardous substance contained in gasoline and diesel exhaust gas, and considered to be one cause of oil odour. ²⁾ SIRIM Berhad (SIRIM), a premier industrial research and technology organization in Malaysia, wholly-owned by the Ministry of Finance Incorporated.

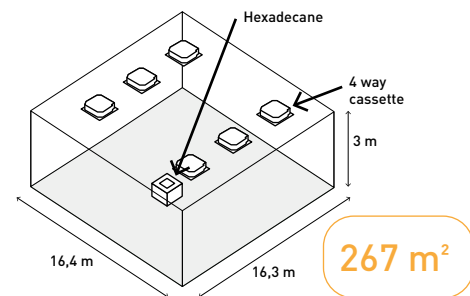

Optional Econavi intelligent sensor

Human activity sensor and floor temperature sensor can reduce waste energy, by optimising air conditioner operation.

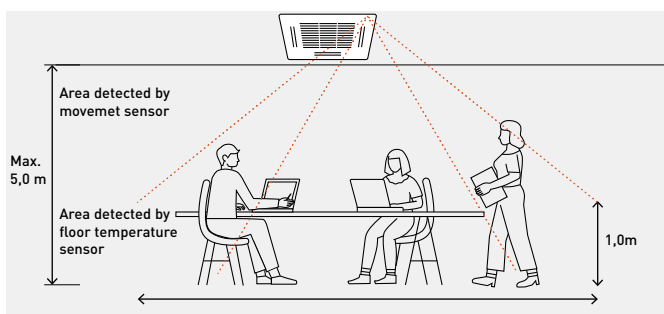

Advanced Econavi functions.

2 sensors (movement and floor temperature) can provide a reduction in wasted energy by means of effective control. The floor temperature can be detected with a ceiling height of 5 m.



Econavi exclusive panel. Optional (CZ-KPU3AW)



Floor temperature sensor.
This sensor detects average floor temperature and operates circulation if floor temperature is low.

Movement sensor.
This sensor detects the amount of human activity, and operates effectively.



Wired remote controller CZ-RTC5B, CZ-RTC6W/BL/BLW or CZ-RTC6/BL/BLW is required.

PACi NX adaptive ducted unit - PF3

The adaptive ducted units provide better flexibility with both installation possibilities, horizontal and vertical. The powerful external static pressure, maximum 150 Pa.





+ SEE PRODUCT SPECIFICATIONS

1 Highly flexible installation
2 installation possibilities (horizontal / vertical).

2 High seasonal performance with slim body
Maximum SEER: 7,4 A++ ¹⁾ / SCOP: 4,7 A++ ²⁾.

3 Comfort operation
Super quiet operation, minimum 22 dB(A)*.

* 3,6 kW model and when operating with external static pressure 50 Pa in low fan mode.

1) For 10,0 kW model. 2) For 7,1 kW model.

2 installation possibilities (horizontal / vertical)

Vertical installation is available. External static pressure 150 Pa, sufficient for remotely installing units away from the rooms.



Improved drain pan design

Just one drain pan for both horizontal and vertical installations. No need to modify the unit.

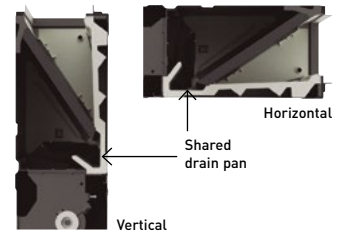

Selectable inlet air position

Inlet air position may be adjusted by means of a removable panel, to allow rear or bottom entry, depending on the duct installation.

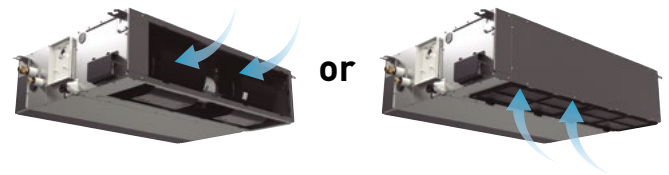

Maximum efficiency

Energy class ¹⁾ and seasonal efficiency value ($\eta_{s,c} / \eta_{s,h}$) ²⁾								
	kW	3,6	5,0	6,0	7,1	10,0	12,5	14,0
Elite		A++	A++	A++	A++	A++	281,7%	275,9%
		A+	A+	A++	A++	A+	170,0%	171,0%
Standard		A+	A++	A++	A++	A++	257,4%	252,2%
		A+	A+	A++	A+	A	142,6%	140,6%

1) Energy label scale from A+++ to D for models below 12,0 kW (EU regulation 626/2011). 2) $\eta_{s,c} / \eta_{s,h}$ values for models above 12,0 kW (EN 14825).

Compact body

- Only 250 mm high
- Light units from 25 to 39 kg

Conventional model	Adaptive ducted
33 kg	30 kg
290 mm	250 mm

Adaptive ducted



Better indoor air quality with nanoe™ X



The performance of nanoe™ X technology is maintained, even with 10 m long ducts*. The effect of improved air quality is sufficient to allow for numerous duct shapes to fit the application.

* Panasonic internal survey.

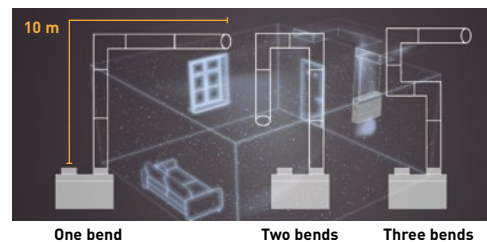

As the experiments demonstrate, up to a duct length of 10 m, effectiveness of nanoe™ X is maintained even if the duct is bended 3 times.

nanoe™ X effect against odour proven in large space

In a room of 139 m², tobacco odour is reduced by a factor of 0,7 when compared to natural reduction over a period of 2 hours.

Tobacco deodorisation ratio.

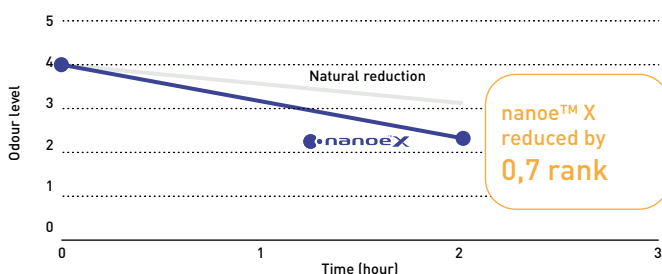

Test ambient.

3rd party international testing institute KAKEN ¹⁾ conducted the performance experiment of Adaptive ducted equipped with nanoe X Generator Mark 2 device removing tobacco odour.

1) KAKEN TEST CENTER General Incorporated Foundation in Japan, international testing institute.

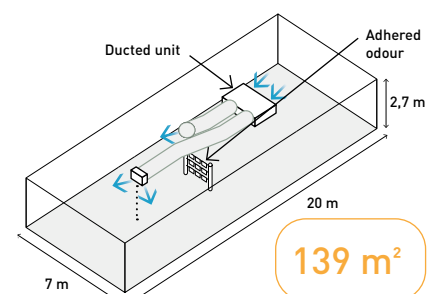

PACi NX wall-mounted, 4 way 60x60 cassette and ceiling



A new era of air conditioning solutions are here, with built-in nanoe™ X technology.



PACi NX wall-mounted - PK3.

Providing a small, lightweight and low noise level design, it is ideal for small offices and other commercial applications. It also has a stylish smooth design with a washable front panel.

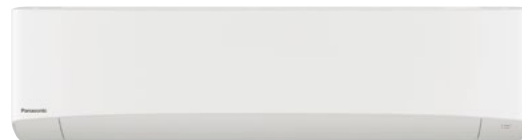

Air distribution is automatically altered depending on the operational mode of the unit

Air outlet angle is automatically adjusted for cooling and heating operation.

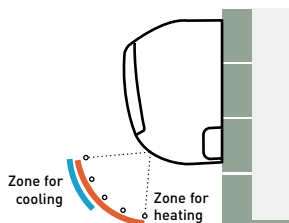

Piping outlet in six directions

Piping outlet is possible in six directions of; right, right rear, right bottom, left, left rear and left bottom, making installation flexible.



[+ SEE PRODUCT SPECIFICATIONS](#)

Closed discharge port

When the unit is turned OFF, the flap closes completely to prevent dust getting into the unit and to keep the equipment clean.

PACi NX 4 way 60x60 cassette - PY3.

The PY3 not only perfectly matches with 600 x 600 mm ceiling grids but also provides an additional benefit for better indoor quality, with nanoe™ X built-in.



Industry-leading energy efficiency

- Energy class A++* with Elite outdoor range
- Energy class A++ with Standard outdoor range 2,5 kW model

* Except for 6,0 kW.

Compact and stylish design

- Required ceiling depth of only 250 mm
- Exposed area is only 30 mm

Internal cleaning function

When cooling or dry operation stopped, internal drying and nanoe™ X circulation airflow is activated in order to suppress the mould proliferation inside the unit (airflow passage, fan, heat exchanger)*.

* Depending on the installation environment or operating hours, mould proliferation or inhabitation of mould growth will be changed.

Individual flap control

Better control of the air flow with 4 motors, providing individual flap control. Perfect air distribution without direct airflow, to reduce the feeling of cold drafts.

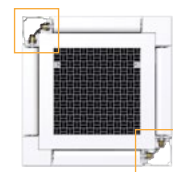

[+ SEE PRODUCT SPECIFICATIONS](#)

PACi NX ceiling - PT3.

Providing outstanding energy-saving performance, comfort and long-distance airflow distribution, these units are perfect for retail stores and schools.



Comfortable, long-distance airflow distribution

The shape of the outlet has been optimised to provide long-distance air flow distribution. Even in long rooms, air flow reaches every corner for exceptionally comfortable air conditioning.

Compact looking, stylish, one-motion design

With its streamlined, one-motion form, the unit looks thin and compact when installed for a neat appearance in any room. When not operating, the louver closes to provide an elegant look while also keeping the unit clean.

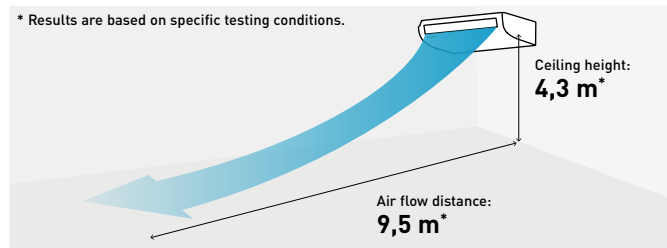

Energy-saving technology delivering top-class efficiency

Optimisation of the shape of the casing and fan assures bigger air flow and higher efficiency. Energy-saving performance is top class in the industry. Thanks to new DC fan motor and large diagonal air flow fan.

[+ SEE PRODUCT SPECIFICATIONS](#)

Solutions for server rooms applications

Effectively protect your IT related spaces, 24/7, with a complete range of solutions offering redundancy control. High efficiency products provide reliable cooling all year round.



YKEA server room solution.

- Perfect solution for smaller server rooms
- Compact design
- Reaching SEER value of 9,6 (A+++)¹⁾
- High seasonal performance
- Range of capacities available
- Operation down to -25 °C ambient

¹⁾ For 3,5 kW unit.

PACi solution.

- Scalability for larger applications
- Twin, triple and double-twin options¹⁾
- Increased piping lengths of up to 90 m²⁾
- Increased sensible capacity options available
- Flexible and adaptable control options

¹⁾ Compatible with PAW-PACR4 only. ²⁾ For Big PACi 20 kW unit.

Redundancy ensured by three different functionalities..

Computer and server rooms are very sensitive areas of application. Any downtime caused by high room temperatures must be avoided by any means. Air conditioner redundancy is one of the key points to ensure a reliable nonstop cooling operation.

1 Backup operation

When an air conditioner fails for whatever reason, another one will awake from standby mode and cover the room's cooling load.

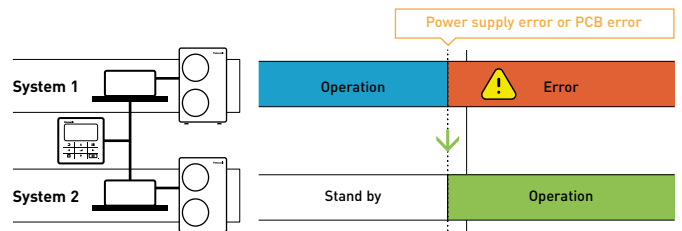

2 Support operation

Support operation, also called cascade control, makes sure that the capacity required to cool the room is delivered by one or more units whenever required. When the capacity of 1 air conditioner is not sufficient, another one will be started to support the operation.

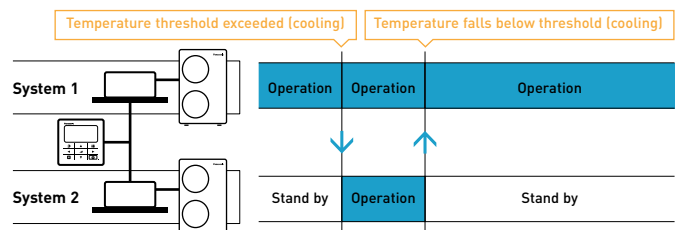

3 Rotation operation

Backup and support operation are key functions for a redundant operation in computer rooms. This concept implies a main system and a sub system. In order to avoid an imbalance of the operating hours of the systems, the redundancy control equalises the operation time by rotating the main and the sub systems, thus providing a "rotation operation".

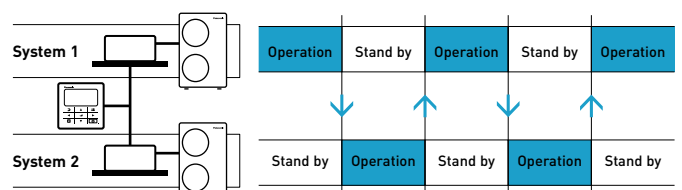

Redundancy control options for 24/7/365 applications

YKEA integral solution

- Ideal solution for small server rooms, providing full redundancy functionality integrated in YKEA's remote controller (requires optional CZ-RCC5 cable set)
- Up to 2 YKEA systems connectable to 1 remote controller
- Individual alarm display for each system
- Operation can be monitored by H&C Controls App (via WLAN)
- No digital inputs/outputs

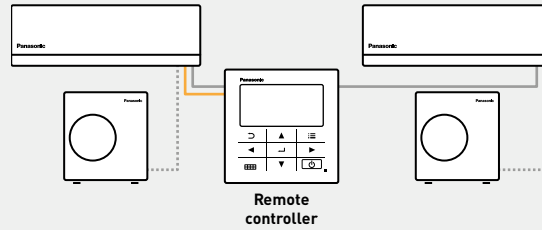

Optional interface for YKEA units

PAW-SERVER-PKEA

- Ideal solution for small server rooms, providing full redundancy functionality
- Up to 2 YKEA systems connectable to PAW-SERVER-PKEA
- Additional benefits: Operation and alarm outputs for each system, ON / OFF inputs for each system for connection to external BMS

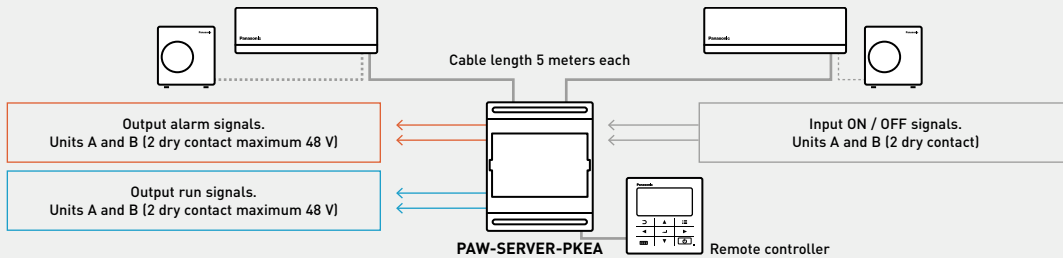

PACi integral solution

CZ-RTC5B / CZ-RTC6W / CZ-RTC6 / CZ-RTC6WBL / CZ-RTC6BL / CZ-RTC6WBLW / CZ-RTC6BLW

- Full redundancy functionality
- Quick and easy installation using PACi group control
- Up to 2 PACi systems connectable to 1 remote controller
- Delta T setting for support operation selectable from 4 to 10 K
- Connectable to Panasonic centralised control systems
- Optional interfaces for connection to external BMS (Modbus, BACnet, KNX)

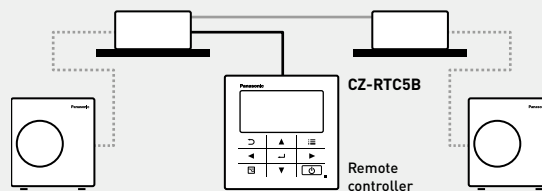







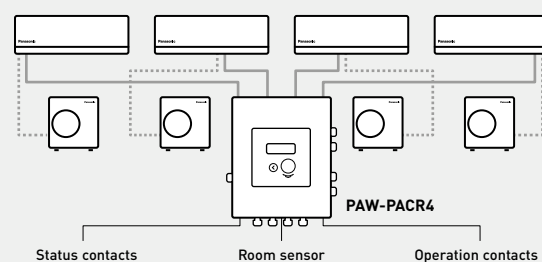



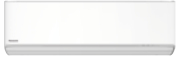
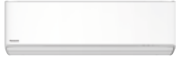
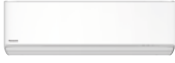
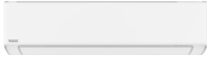
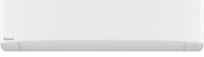
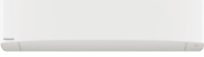
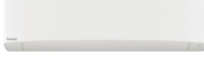
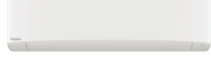













NEW Optional interface up to 4 indoor units PACi or VRF

PAW-PACR4

- Redundancy control up to 4 indoor unit groups
- Actual unit operation / alarm status can be displayed
- Common digital alarm / operation status output
- For each support operation level, individual temperature thresholds can be set (cascade control)
- Room temperature display (by device's own temperature sensor)
- Modbus connection (up to 4 PAW-RC2-MBS-1)
- Available external inputs (ON / OFF, heating/cooling change, fire prevention contact)



Commercial units range

Page	Indoor units	2,5 kW	3,6 kW	4,5 kW ¹⁾	5,0 kW	6,0 kW
P. 178	Wall-mounted Professional · R32 ²⁾	 CS-Z25YKEA	 CS-Z35YKEA	 CS-Z42YKEA	 CS-Z50YKEA	
P. 180	PACi NX wall-mounted · R32		 S-3650PK3E	 S-3650PK3E	 S-3650PK3E	 S-6010PK3E
P. 184	PACi NX 4 way 60x60 cassette · R32	 S-25PY3E	 S-36PY3E	 S-50PY3E	 S-60PY3E	
P. 186	PACi NX 4 way 90x90 cassette · R32		 S-3650PU3E	 S-3650PU3E	 S-3650PU3E	 S-6071PU3E
P. 190	PACi NX ceiling · R32		 S-3650PT3E	 S-3650PT3E	 S-3650PT3E	 S-6071PT3E
P. 194	PACi NX adaptive ducted · R32		 S-3650PF3E	 S-3650PF3E	 S-3650PF3E	 S-6071PF3E
P. 198	High static pressure hide-away 20-25 kW · R32					
<hr/>						
Outdoor units	2,5 kW	3,6 kW	4,5 kW	5,0 kW	6,0 kW	
PACi NX Elite · R32		 U-36PZH3E5		 U-50PZH3E5	 U-60PZH3E5	
PACi NX Standard · R32	 U-25PZ3E5	 U-36PZ3E5		 U-50PZ3E5	 U-60PZ3E5A	

1) The 4,5 kW indoor capacity options are only available only for twin, triple and double-twin combinations. 2) Not compatible with PACi NX outdoors and accessories. Domestic range sales conditions may apply. Check with your sales representative. 3) These two units are not in PACi NX range but part of Big PACi range. * U-__E5 Single phase / U-__E8 Three phase.

+ OPTIONAL UNITS ON VENTILATION SECTION

7,1 kW

10,0 kW

12,5 kW

14,0 kW

20,0 kW

25,0 kW



CS-Z71YKEA



S-6010PK3E



S-6010PK3E



S-6071PU3E



S-1014PU3E



S-1014PU3E



S-1014PU3E



S-6071PT3E



S-1014PT3E



S-1014PT3E



S-1014PT3E



S-6071PF3E



S-1014PF3E



S-1014PF3E



S-1014PF3E



S-200PE3E5B



S-250PE3E5B

7,1 kW

10,0 kW

12,5 kW

14,0 kW

20,0 kW

25,0 kW



U-71PZH4E5 / U-71PZH4E8



U-100PZH4E5 / U-100PZH4E8



U-125PZH4E5 / U-125PZH4E8



U-140PZH4E5 / U-140PZH4E8



U-200PZH2E8 ³⁾



U-250PZH2E8 ³⁾



U-71PZ3E5A



U-100PZ3E5 / U-100PZ3E8



U-125PZ3E5 / U-125PZ3E8



U-140PZ3E5 / U-140PZ3E8

YKEA series for server rooms

High efficiency products for 24/7 applications. Panasonic has developed a complete range of solutions for server rooms which efficiently protect your servers, keeping them at an appropriate temperature even when the outdoor temperature is below -25 °C.



1 Designed for 24h/7d a week operation

High efficiency all year round. This wall-mounted air conditioner is designed for professional, critical applications such as computer rooms where reliable cooling inside the room is necessary even with extreme ambient conditions.

2 Remote controller for better usability

Wired remote controller, which can assure the operation 24/7 of two server room units, thanks to the integrated duty rotation mode. This function manages rotation and backup of two units and it is available when connecting an optional CN-CNT cable (CZ-RCC5) between the controller and each of the two indoor units.

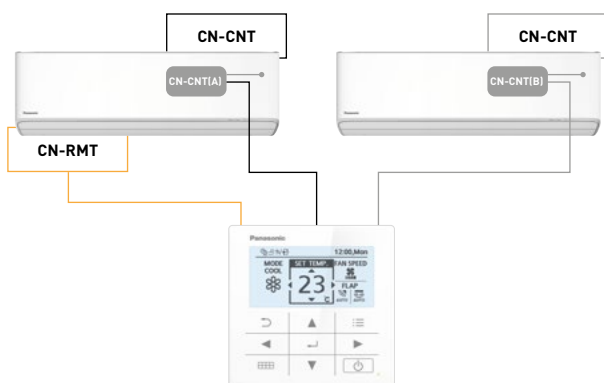

3 Highest energy rating in cooling

The SEER and SCOP of the Server room unit has been further improved to achieve top class energy efficiency. The 3,5 kW unit reaches now the SEER value of 9,6 (A+++).

4 Built-in Wi-Fi and compatible with Voice Assistant

The unit is ready to connect to the internet and to be controlled by smartphone with Panasonic Comfort Cloud App. Control, monitor energy consumption statistics and easily identify errors in case of failure.

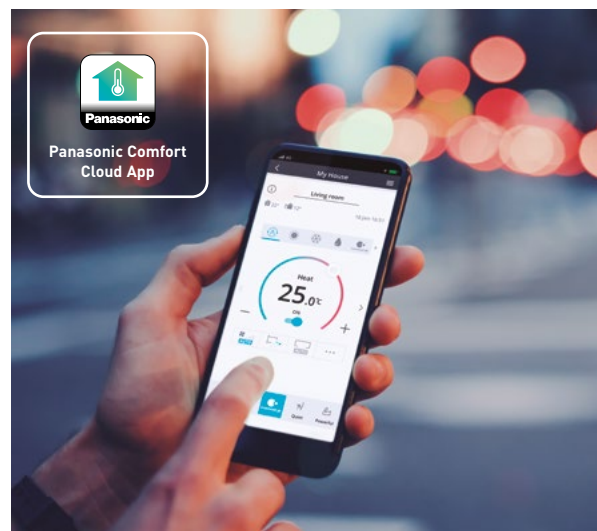

Not compatible with PACi NX outdoors and accessories. Domestic range sales conditions may apply. Check with your sales representative.

Wall-mounted Professional -25 °C · R32

- Designed for 24h/7d a week operation
- Wired remote controller, with optional duty rotation mode
- Improved SEER / SCOP to achieve top class energy efficiency
- Aerowings 2.0, for a better control of the airflow
- Built-in Wi-Fi for instant connectivity via Panasonic Comfort Cloud App
- Compatible with Google Assistant and Amazon Alexa
- Chassis and parts designed for easier installation



Kit			KIT-Z25-YKEA	KIT-Z35-YKEA	KIT-Z42-YKEA	KIT-Z50-YKEA	KIT-Z71-YKEA
Cooling capacity	Nominal (Min - Max)	kW	2,50 (0,85 - 3,50)	3,50 (0,85 - 4,20)	4,20 (0,85 - 5,00)	5,00 (0,98 - 6,00)	7,10 (0,98 - 8,50)
EER ¹⁾	Nominal (Min - Max)	W/W	4,90 (4,72 - 3,98)	4,12 (4,72 - 3,68)	3,82 (4,72 - 3,25)	3,68 (3,92 - 3,16)	3,23 (2,33 - 2,83)
SEER ²⁾			9,5 A+++	9,6 A+++	8,6 A+++	8,6 A+++	6,5 A++
P _{design}		kW	2,50	3,50	4,20	5,00	7,10
Input power	Nominal (Min - Max)	kW	0,51 (0,18 - 0,88)	0,85 (0,18 - 1,14)	1,10 (0,18 - 1,54)	1,36 (0,25 - 1,90)	2,20 (0,42 - 3,00)
Annual energy consumption ³⁾		kWh/a	92	128	171	203	382
Heating capacity	Nominal (Min - Max)	kW	3,40 (0,85 - 5,00)	4,00 (0,85 - 5,80)	5,30 (0,85 - 6,80)	5,80 (0,98 - 8,00)	8,20 (0,98 - 10,20)
Heating capacity at -7 °C		kW	3,05	3,40	4,11	4,80	6,31
COP ¹⁾	Nominal (Min - Max)	W/W	4,86 (4,72 - 3,97)	4,44 (4,72 - 3,87)	3,93 (4,72 - 3,66)	4,08 (4,26 - 3,35)	3,71 (2,45 - 3,29)
SCOP ²⁾			4,6 A++	4,6 A++	4,5 A+	4,6 A++	4,1 A+
P _{design} at -10 °C		kW	2,70	3,20	3,60	4,20	5,50
Input power	Nominal (Min - Max)	kW	0,70 (0,18 - 1,26)	0,90 (0,18 - 1,50)	1,35 (0,18 - 1,86)	1,42 (0,23 - 2,39)	2,21 (0,40 - 3,10)
Annual energy consumption ³⁾		kWh/a	822	974	1120	1278	1878
Indoor unit			CS-Z25YKEA	CS-Z35YKEA	CS-Z42YKEA	CS-Z50YKEA	CS-Z71YKEA
Power supply		V	230	230	230	230	230
Recommended fuse		A	16	16	16	16	20
Connection indoor / outdoor		mm ²	4 x 1,5	4 x 1,5	4 x 1,5	4 x 2,5	4 x 2,5
Air flow	Cool / Heat	m ³ /min	11,4 / 13,8	12,7 / 14,8	13,2 / 15,2	17,4 / 19,1	19,0 / 19,9
Moisture removal volume		L/h	1,5	2,0	2,4	2,8	4,1
Sound pressure ⁴⁾	Cool (Hi / Lo / Q-Lo)	dB(A)	39 / 25 / 21	42 / 28 / 21	43 / 32 / 29	44 / 37 / 30	47 / 38 / 35
	Heat (Hi / Lo / Q-Lo)	dB(A)	41 / 27 / 22	43 / 30 / 22	44 / 35 / 29	44 / 37 / 30	47 / 38 / 35
Sound power	Cool / Heat (Hi)	dB(A)	55 / 57	58 / 59	59 / 60	60 / 60	63 / 63
Dimension	H x W x D	mm	295 x 870 x 229	295 x 870 x 229	295 x 870 x 229	295 x 1040 x 244	295 x 1040 x 244
Net weight		kg	11	11	11	12	13
Outdoor unit			CU-Z25YKEA	CU-Z35YKEA	CU-Z42YKEA	CU-Z50YKEA	CU-Z71YKEA
Air flow	Cool / Heat	m ³ /min	27,6 / 27,6	29,8 / 29,8	29,8 / 31,0	39,8 / 36,9	44,7 / 45,8
Sound pressure ⁴⁾	Cool / Heat (Hi)	dB(A)	46 / 48	48 / 50	48 / 51	48 / 50	52 / 54
Sound power	Cool / Heat (Hi)	dB(A)	61 / 63	63 / 65	63 / 66	63 / 65	66 / 68
Dimension ⁵⁾	H x W x D	mm	542 x 780 x 289	542 x 780 x 289	542 x 780 x 289	695 x 875 x 320	695 x 875 x 320
Net weight		kg	30	30	30	40	45
Piping diameter	Liquid	Inch (mm)	1/4 (6,35)	1/4 (6,35)	1/4 (6,35)	1/4 (6,35)	1/4 (6,35)
	Gas	Inch (mm)	3/8 (9,52)	3/8 (9,52)	1/2 (12,70)	1/2 (12,70)	5/8 (15,88)
Pipe length range		m	3 - 20	3 - 20	3 - 20	3 - 30	3 - 30
Elevation difference (in / out)		m	15	15	15	15	20
Pre-charged pipe length		m	7,5	7,5	7,5	7,5	10
Additional gas amount		g/m	10	10	10	15	25
Refrigerant (R32) / CO ₂ Eq.		kg / T	0,89 / 0,60	0,89 / 0,60	0,97 / 0,65	1,13 / 0,76	1,35 / 0,91
Operating range	Cool Min ~ Max	°C	-25 ~ +43	-25 ~ +43	-25 ~ +43	-25 ~ +43	-25 ~ +43
	Heat Min ~ Max	°C	-15 ~ +24	-15 ~ +24	-15 ~ +24	-15 ~ +24	-15 ~ +24

1) EER and COP calculation is based in accordance to EN14511. 2) Energy Label Scale from A+++ to D. 3) The annual energy consumption is calculated in accordance to EU/626/2011. 4) The sound pressure of the indoor unit shows the value measured of a position 1 m in front of the main body and 0,8 m below the unit. For outdoor unit 1 m in front and 1 m in rear side of main body. The sound pressure is measured in accordance with JIS C 9612. Q-Lo: Quiet mode. Lo: The lowest set fan speed. 5) Add 70 mm for piping port. * Not compatible with PACI NX outdoors and accessories. Domestic range sales conditions may apply. Check with your sales representative.

Accessories	
CZ-RCC5	CN-CNT cables x2 for server room application, control of 2 units, rotation, backup, etc.
PAW-WTRAY	Tray for condenser water compatible with outdoor elevation platform

Accessories	
PAW-GRDBSE20	Outdoor base ground support for noise and vibration absorption
PAW-GRDSTD40	Outdoor elevation platform 400 x 900 x 400 mm



SEER: For KIT-Z35-YKEA. SCOP: For KIT-Z25-YKEA, KIT-Z35-YKEA and KIT-Z50-YKEA. SUPER QUIET: For KIT-Z25-YKEA. INTERNET CONTROL: Built-in Wi-Fi.

Rating conditions: Cooling indoor 27 °C DB / 19 °C WB. Cooling outdoor 35 °C DB / 24 °C WB. Heating indoor 20 °C DB. Heating outdoor 7 °C DB / 6 °C WB. (DB: Dry Bulb; WB: Wet Bulb). Specifications subject to change without notice. For detailed information about ErP / Energy Labelling, please visit our websites www.aircon.panasonic.eu or www.ptc.panasonic.eu.

PACi NX Series Elite wall-mounted - PK3 - R32

The wall-mounted units with stylish matt color can be offered for many applications such as studios, gyms, high ceiling areas and even computer server rooms.

The compact design and flat face ensure discreet installation, even in a small space.



			Single phase				
			3,6 kW	5,0 kW	6,0 kW	7,1 kW	10,0 kW
Kit			KIT-36PK3ZH5	KIT-50PK3ZH5	KIT-60PK3ZH5	KIT-71PK3ZH45	KIT-100PK3ZH45
Remote controller			CZ-RTC5B	CZ-RTC5B	CZ-RTC5B	CZ-RTC5B	CZ-RTC5B
Cooling capacity	Nominal (Min - Max)	kW	3,6 [1,2 - 4,0]	5,0 [1,2 - 5,6]	6,1 [1,2 - 7,1]	7,1 [2,2 - 9,0]	9,5 [3,1 - 10,5]
EER ¹⁾	Nominal (Min - Max)	W/W	4,93 [4,49 - 5,45]	4,24 [3,61 - 5,45]	3,86 [3,02 - 5,45]	3,50 [2,69 - 5,79]	3,21 [3,09 - 5,34]
SEER ²⁾			8,4 A++	8,0 A++	7,2 A++	6,8 A++	6,4 A++
Pdesign		kW	3,6	5,0	6,1	7,1	9,5
Input power	Nominal (Min - Max)	kW	0,73 [0,22 - 0,89]	1,18 [0,22 - 1,55]	1,58 [0,22 - 2,35]	2,03 [0,38 - 3,35]	2,96 [0,58 - 3,40]
Annual energy consumption ³⁾		kWh/a	150	219	297	365	520
Heating capacity	Nominal (Min - Max)	kW	4,0 [1,2 - 5,0]	5,6 [1,2 - 6,5]	7,0 [1,2 - 8,0]	8,0 [2,0 - 9,0]	9,5 [3,1 - 11,5]
COP ¹⁾	Nominal (Min - Max)	W/W	4,82 [4,17 - 5,45]	4,15 [3,55 - 5,45]	4,19 [3,40 - 5,45]	4,00 [3,16 - 5,56]	3,88 [3,43 - 5,54]
SCOP ²⁾			4,9 A++	4,7 A++	4,8 A++	4,7 A++	3,9 A
Pdesign at -10 °C		kW	3,6	4,5	4,6	5,2	8,0
Input power	Nominal (Min - Max)	kW	0,83 [0,22 - 1,20]	1,35 [0,22 - 1,83]	1,67 [0,22 - 2,35]	2,00 [0,36 - 2,85]	2,45 [0,56 - 3,35]
Annual energy consumption ³⁾		kWh/a	1029	1341	1342	1549	2871
Indoor unit			S-3650PK3E	S-3650PK3E	S-6010PK3E	S-6010PK3E	S-6010PK3E
Air flow	Hi / Med / Lo	m ³ /min	13,0/11,0/9,0	16,0/13,5/11,0	20,0/17,5/14,5	20,0/17,5/14,5	22,0/18,5/15,5
Moisture removal volume		L/h	0,9	1,8	2,0	3,0	4,8
Sound pressure ⁴⁾	Hi / Med / Lo	dB(A)	35/31/27	40/36/32	47/44/40	47/44/40	49/45/41
Sound power	Hi / Med / Lo	dB(A)	51/47/43	56/52/48	63/60/56	63/60/56	65/61/57
Dimension	H x W x D	mm	302 x 1120 x 236	302 x 1120 x 236	302 x 1120 x 236	302 x 1120 x 236	302 x 1120 x 236
Net weight		kg	13	13	14	14	14
nanoe X Generator			Mark 2	Mark 2	Mark 2	Mark 2	Mark 2
Outdoor unit			U-36PZH3E5	U-50PZH3E5	U-60PZH3E5	U-71PZH4E5	U-100PZH4E5
Power supply		V	220 - 230 - 240	220 - 230 - 240	220 - 230 - 240	220 - 230 - 240	220 - 230 - 240
Current	Cool	A	3,60 - 3,45 - 3,30	5,60 - 5,35 - 5,10	7,40 - 7,10 - 6,80	10,3 - 9,80 - 9,40	14,60 - 14,00 - 13,40
	Heat	A	4,05 - 3,90 - 3,70	6,40 - 6,10 - 5,85	7,75 - 7,40 - 7,10	10,10 - 9,65 - 9,25	12,00 - 11,60 - 11,10
Air flow	Cool / Heat	m ³ /min	34,1/36,4	42,0/42,0	42,0/42,0	62,0/66,0	76,0/70,0
Sound pressure	Cool / Heat (Hi)	dB(A)	43/44	46/48	47/50	48/50	52/52
Sound power	Cool / Heat (Hi)	dB(A)	62/64	64/67	65/69	65/67	69/69
Dimension	H x W x D	mm	695 x 875 x 320	695 x 875 x 320	695 x 875 x 320	996 x 980 x 370	996 x 980 x 370
Net weight		kg	42	42	43	66	84
Piping diameter	Liquid	Inch (mm)	1/4 (6,35)	1/4 (6,35)	1/4 (6,35) ⁵⁾	3/8 (9,52)	3/8 (9,52)
	Gas	Inch (mm)	1/2 (12,70)	1/2 (12,70)	1/2 (12,70) ⁶⁾	5/8 (15,88)	5/8 (15,88)
Pipe length range		m	3 - 40	3 - 40	3 - 40	5 - 60	5 - 100
Elevation difference (in / out) ⁷⁾		m	15/30	15/30	15/30	15/30	15/30
Pre-charged pipe length		m	30	30	30	30	30
Additional gas amount		g/m	15	15	15	30	40
Refrigerant (R32) / CO ₂ Eq.		kg / T	1,13/0,76	1,13/0,76	1,15/0,78	1,95/1,32	2,70/1,82
Operating range	Cool Min ~ Max	°C	-15 ~ +46	-15 ~ +46	-15 ~ +46	-15 ~ +52	-20 ⁸⁾ ~ +52
	Heat Min ~ Max	°C	-20 ~ +24	-20 ~ +24	-20 ~ +24	-20 ~ +24	-20 ~ +24

Technical focus

- Modern design with flat face and compact size
- DC fan for better efficiency and control
- Six directional piping outlet
- nanoe™ X (Generator Mark 2: 9,6 trillion hydroxyl radicals/sec) as standard for better indoor air quality
- Wired remote control CZ-RTC6WBL and CZ-RTC6BL allows easy system setting via Bluetooth®
- Easy connection and control of external fan or ERV using the connector PAW-FDC on the indoor unit PCB. The external device can be controlled by the remote control of the Panasonic indoor unit

Closed discharge port

When the unit is turned OFF, the flap closes completely to prevent dust getting into the unit and to keep the equipment clean.

Quiet operation

These units are among the quietest in the industry, making them ideal for hotels and hospitals.

Piping outlet in six directions

Piping outlet is possible in six directions of right, right rear, right bottom, left, left rear and left bottom, making the installation work more flexible.



CZ-RTC5B

COMPATIBLE WITH ALL PANASONIC CONNECTIVITY SOLUTIONS. FOR DETAILED INFORMATION GO TO THE CONTROL SYSTEMS SECTION

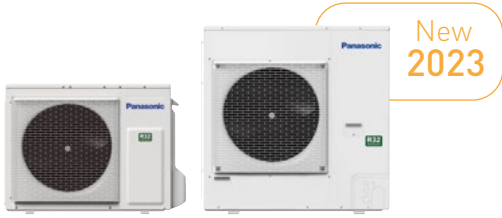

Optional:



CONEX wired remote controller, white. CZ-RTC6W/BL/BLW



CONEX wired remote controller, black. CZ-RTC6/BL/BLW



Infrared remote controller. CZ-RWS3



Econavi sensor. CZ-CENSC1

Three phase

			7,1 kW	10,0 kW
Kit			KIT-71PK3ZH48	KIT-100PK3ZH48
Remote controller			CZ-RTC5B	CZ-RTC5B
Cooling capacity	Nominal (Min - Max)	kW	7,1 (2,2 - 9,0)	9,5 (3,1 - 10,5)
EER ¹⁾	Nominal (Min - Max)	W/W	3,50 (2,69 - 5,79)	3,21 (3,09 - 5,34)
SEER ²⁾			6,7 A++	6,3 A++
Pdesign		kW	7,1	9,5
Input power	Nominal (Min - Max)	kW	2,03 (0,38 - 3,35)	2,96 (0,58 - 3,40)
Annual energy consumption ³⁾		kWh/a	370	526
Heating capacity	Nominal (Min - Max)	kW	8,0 (2,0 - 9,0)	9,5 (3,1 - 11,5)
COP ¹⁾	Nominal (Min - Max)	W/W	4,00 (3,16 - 5,56)	3,88 (3,43 - 5,54)
SCOP ²⁾			4,7 A++	3,9 A
Pdesign at -10 °C		kW	5,2	8,0
Input power	Nominal (Min - Max)	kW	2,00 (0,36 - 2,85)	2,45 (0,56 - 3,35)
Annual energy consumption ³⁾		kWh/a	1549	2871
Indoor unit			S-6010PK3E	S-6010PK3E
Air flow	Hi / Med / Lo	m ³ /min	20,0/17,5/14,5	22,0/18,5/15,0
Moisture removal volume		L/h	3,0	4,8
Sound pressure ⁴⁾	Hi / Med / Lo	dB(A)	47/44/40	49/45/41
Sound power	Hi / Med / Lo	dB(A)	63/60/56	65/61/57
Dimension	HxWxD	mm	302x1120x236	302x1120x236
Net weight		kg	14	14
nanoe X Generator			Mark 2	Mark 2
Outdoor unit			U-71PZH4E8	U-100PZH4E8
Power supply		V	380-400-415	380-400-415
Current	Cool	A	3,45-3,25-3,15	4,95-4,70-4,50
	Heat	A	3,40-3,20-3,10	4,10-3,90-3,70
Air flow	Cool / Heat	m ³ /min	62,0/66,0	76,0/70,0
Sound pressure	Cool / Heat (Hi)	dB(A)	48/50	52/52
Sound power	Cool / Heat (Hi)	dB(A)	65/67	69/69
Dimension	HxWxD	mm	996x980x370	996x980x370
Net weight		kg	66	82
Piping diameter	Liquid	Inch (mm)	3/8 (9,52)	3/8 (9,52)
	Gas	Inch (mm)	5/8 (15,88)	5/8 (15,88)
Pipe length range		m	5-60	5-100
Elevation difference (in / out) ⁷⁾		m	15/30	15/30
Pre-charged pipe length		m	30	30
Additional gas amount		g/m	30	40
Refrigerant (R32) / CO ₂ Eq.		kg / T	1,95/1,32	2,70/1,82
Operating range	Cool Min ~ Max	°C	-15 ~ +52	-20 ⁸⁾ ~ +52
	Heat Min ~ Max	°C	-20 ~ +24	-20 ~ +24

1) EER and COP calculation is based in accordance to EN14511. 2) For models below 12 kW, the SEER and SCOP is calculated based on values of EU/626/2011. For models above 12 kW, the $\eta_{s,c}$ / $\eta_{s,h}$ values is calculated based on EN 14825. 3) Factory setting. 4) The sound pressure of the units shows the value measured of the position 1 m in front of the main body and 1 m below the unit. The sound pressure is measured in accordance with Eurovent 6/C/006-97 specification. 5) Connect the liquid socket tube (Ø6,35-Ø9,52) to the liquid tubing side indoor unit. 6) Connect the gas socket tube (Ø12,70-Ø15,88) to the gas tubing side indoor unit. 7) Outdoor unit located lower / outdoor unit located higher. 8) Pipe length up to 30 m. * Recommended fuse for the indoor 3 A. ** Above values are in the case of nanoe™ X OFF.

Accessories

CZ-RTC6W	CONEX wired remote controller (non-wireless), white
CZ-RTC6WBL	CONEX wired remote controller with Bluetooth®, white
CZ-RTC6WBLW	CONEX wired remote controller with Wi-Fi and Bluetooth®, white
CZ-RTC6	CONEX wired remote controller (non-wireless), black
CZ-RTC6BL	CONEX wired remote controller with Bluetooth®, black
CZ-RTC6BLW	CONEX wired remote controller with Wi-Fi and Bluetooth®, black
CZ-RTC5B	Wired remote controller with Econavi function and datanavi
CZ-RWS3	Infrared remote controller

Accessories

CZ-CAPWFC1	Commercial Wi-Fi Adaptor
PAW-PACR4	Interface to run up to 4 indoor unit groups on backup and alternative run
PAW-WTRAY	Tray for condenser water compatible with outdoor elevation platform
PAW-GRDBSE20	Outdoor base ground support for noise and vibration absorption
PAW-GRDSTD40	Outdoor elevation platform 400x900x400 mm
CZ-CENSC1	Econavi energy saving sensor



SEER and SCOP: For S-3650PK3E + U-36PZH3E5. INTERNET CONTROL: Optional.

Rating conditions: Cooling indoor 27 °C DB / 19 °C WB. Cooling outdoor 35 °C DB / 24 °C WB. Heating indoor 20 °C DB. Heating outdoor 7 °C DB / 6 °C WB. (DB: Dry Bulb; WB: Wet Bulb). Specifications subject to change without notice. For detailed information about ErP / Energy Labelling, please visit our websites www.aircon.panasonic.eu or www.ptc.panasonic.eu.

PACi NX Series Standard wall-mounted - PK3 · R32

The wall-mounted units with stylish matt color can be offered for many applications such as studios, gyms, high ceiling areas and even computer server rooms.

The compact design and flat face ensure discreet installation, even in a small space.



			Single phase				
			3,6 kW	5,0 kW	6,0 kW	7,1 kW	10,0 kW
Kit			KIT-36PK3Z5	KIT-50PK3Z5	KIT-60PK3Z5	KIT-71PK3Z5	KIT-100PK3Z5
Remote controller			CZ-RTC5B	CZ-RTC5B	CZ-RTC5B	CZ-RTC5B	CZ-RTC5B
Cooling capacity	Nominal (Min - Max)	kW	3,6(1,5 - 4,0)	5,0(1,5 - 5,6)	6,1(2,0 - 7,1)	7,1(2,6 - 7,7)	9,0(3,0 - 9,7)
EER ¹⁾	Nominal (Min - Max)	W/W	4,14(3,74 - 5,88)	3,52(3,03 - 6,25)	3,67(3,01 - 6,90)	3,16(2,77 - 5,00)	3,47(3,13 - 5,36)
SEER ²⁾			7,6 A++	7,4 A++	7,0 A++	5,8 A+	6,5 A++
Pdesign		kW	3,6	5,0	6,1	7,1	9,0
Input power	Nominal (Min - Max)	kW	0,87(0,26 - 1,07)	1,42(0,24 - 1,85)	1,66(0,29 - 2,36)	2,25(0,52 - 2,78)	2,59(0,56 - 3,10)
Annual energy consumption ³⁾		kWh/a	166	237	3,05	429	485
Heating capacity	Nominal (Min - Max)	kW	3,6(1,5 - 4,6)	5,0(1,5 - 6,4)	6,1(1,8 - 7,0)	7,1(2,1 - 8,1)	9,0(3,0 - 10,5)
COP ¹⁾	Nominal (Min - Max)	W/W	4,62(4,11 - 6,52)	4,20(3,17 - 7,50)	4,39(3,18 - 7,50)	4,23(3,38 - 6,36)	3,93(3,56 - 5,36)
SCOP ²⁾			4,5 A+	4,4 A+	4,7 A++	4,4 A+	3,9 A
Pdesign at -10 °C		kW	2,8	4,0	4,6	5,2	9,0
Input power	Nominal (Min - Max)	kW	0,78(0,23 - 1,12)	1,19(0,20 - 2,02)	1,39(0,24 - 2,20)	1,68(0,33 - 2,40)	2,29(0,56 - 2,95)
Annual energy consumption ³⁾		kWh/a	872	1273	1370	1653	3231
Indoor unit			S-3650PK3E	S-3650PK3E	S-6010PK3E	S-6010PK3E	S-6010PK3E
Air flow	Hi / Med / Lo	m ³ /min	13,0/11,0/9,0	16,0/13,5/11,0	20,0/17,5/14,5	20,0/17,5/14,5	22,0/18,5/15,0
Moisture removal volume		L/h	0,9	1,8	2,0	3,0	4,3
Sound pressure ⁴⁾	Hi / Med / Lo	dB(A)	35/31/27	40/36/32	47/44/40	47/44/40	49/45/41
Sound power	Hi / Med / Lo	dB(A)	51/47/43	56/52/48	63/60/56	63/60/56	65/61/57
Dimension	H x W x D	mm	302 x 1120 x 236	302 x 1120 x 236	302 x 1120 x 236	302 x 1120 x 236	302 x 1120 x 236
Net weight		kg	13	13	14	14	14
nanoe X Generator			Mark 2	Mark 2	Mark 2	Mark 2	Mark 2
Outdoor unit			U-36PZ3E5	U-50PZ3E5	U-60PZ3E5A	U-71PZ3E5A	U-100PZ3E5
Power supply		V	220 - 230 - 240	220 - 230 - 240	220 - 230 - 240	220 - 230 - 240	220 - 230 - 240
Current	Cool	A	4,05 - 3,85 - 3,70	6,60 - 6,30 - 6,05	7,70 - 7,35 - 7,05	10,4 - 10,00 - 9,55	12,9 - 12,4 - 11,9
	Heat	A	3,65 - 3,50 - 3,35	5,60 - 5,35 - 5,10	6,45 - 6,15 - 5,90	7,80 - 7,45 - 7,15	11,4 - 10,9 - 10,5
Air flow	Cool / Heat	m ³ /min	33,6/34,0	32,7/31,9	42,6/41,5	44,7/45,9	73,0/73,0
Sound pressure	Cool / Heat (Hi)	dB(A)	46/47	46/46	47/48	48/49	52/52
Sound power	Cool / Heat (Hi)	dB(A)	64/66	64/64	64/65	66/68	70/70
Dimension	H x W x D	mm	619 x 824 x 299	619 x 824 x 299	695 x 875 x 320	695 x 875 x 320	996 x 980 x 370
Net weight		kg	32	35	42	50	83
Piping diameter	Liquid	Inch (mm)	1/4 (6,35)	1/4 (6,35)	1/4 (6,35) ⁵⁾	1/4 (6,35) ⁵⁾	3/8(9,52)
	Gas	Inch (mm)	1/2(12,70)	1/2(12,70)	1/2(12,70) ⁶⁾	5/8(15,88) ⁶⁾	5/8(15,88)
Pipe length range		m	3 - 15	3 - 20	3 - 40	3 - 40	5 - 50
Elevation difference (in / out) ⁷⁾		m	15/15	15/15	15/30	20/30	15/30
Pre-charged pipe length		m	7,5	7,5	30	30	30
Additional gas amount		g/m	10	15	15	17	45
Refrigerant (R32) / CO ₂ Eq.		kg / T	0,87/0,59	1,14/0,77	1,15/0,78	1,32/0,89	2,4/1,62
Operating range	Cool Min ~ Max	°C	-10 ~ +43	-10 ~ +43	-10 ~ +43	-10 ~ +43	-10 ~ +43
	Heat Min ~ Max	°C	-15 ~ +24	-15 ~ +24	-15 ~ +24	-15 ~ +24	-15 ~ +24

Technical focus

- Modern design with flat face and compact size
- DC fan for better efficiency and control
- Six directional piping outlet
- nanoe™ X (Generator Mark 2: 9,6 trillion hydroxyl radicals/sec) as standard for better indoor air quality
- Wired remote control CZ-RTC6WBL and CZ-RTC6BL allows easy system setting via Bluetooth®
- Easy connection and control of external fan or ERV using the connector PAW-FDC on the indoor unit PCB. The external device can be controlled by the remote control of the Panasonic indoor unit

Closed discharge port

When the unit is turned OFF, the flap closes completely to prevent dust getting into the unit and to keep the equipment clean.

Quiet operation

These units are among the quietest in the industry, making them ideal for hotels and hospitals.

Piping outlet in six directions

Piping outlet is possible in six directions of right, right rear, right bottom, left, left rear and left bottom, making the installation work more flexible.



CZ-RTC5B

COMPATIBLE WITH ALL PANASONIC CONNECTIVITY SOLUTIONS. FOR DETAILED INFORMATION GO TO THE CONTROL SYSTEMS SECTION



Optional:



CONEX wired remote controller, white. CZ-RTC6W/BL/BLW



CONEX wired remote controller, black. CZ-RTC6/BL/BLW



Infrared remote controller. CZ-RWS3



Econavi sensor. CZ-CENSC1

			Three phase
			10,0 kW
Kit			KIT-100PK3Z8
Remote controller			CZ-RTC5B
Cooling capacity	Nominal (Min - Max)	kW	9,0 (3,0 - 9,7)
EER ¹⁾	Nominal (Min - Max)	W/W	3,47 (5,36 - 3,13)
SEER ²⁾			6,5 A++
Pdesign		kW	9,0
Input power	Nominal (Min - Max)	kW	2,59 (0,56 - 3,10)
Annual energy consumption ³⁾		kWh/a	485
Heating capacity	Nominal (Min - Max)	kW	9,0 (3,0 - 10,5)
COP ¹⁾	Nominal (Min - Max)	W/W	3,93 (5,36 - 3,56)
SCOP ²⁾			3,9 A
Pdesign at -10 °C		kW	9,0
Input power	Nominal (Min - Max)	kW	2,29 (0,56 - 2,95)
Annual energy consumption ³⁾		kWh/a	3231
Indoor unit			S-6010PK3E
Air flow	Hi / Med / Lo	m ³ /min	22,0 / 18,5 / 15,0
Moisture removal volume		L/h	4,3
Sound pressure ⁴⁾	Hi / Med / Lo	dB(A)	49 / 45 / 41
Sound power	Hi / Med / Lo	dB(A)	65 / 61 / 57
Dimension	H x W x D	mm	302 x 1120 x 236
Net weight		kg	14
nanoe X Generator			Mark 2
Outdoor unit			U-100PZ3E8
Power supply		V	380 - 400 - 415
Current	Cool	A	4,30 - 4,10 - 3,95
	Heat	A	3,80 - 3,65 - 3,50
Air flow	Cool / Heat	m ³ /min	73,0 / 73,0
Sound pressure	Cool / Heat (Hi)	dB(A)	52 / 52
Sound power	Cool / Heat (Hi)	dB(A)	70 / 70
Dimension	H x W x D	mm	996 x 980 x 370
Net weight		kg	83
Piping diameter	Liquid	Inch (mm)	3/8 (9,52)
	Gas	Inch (mm)	5/8 (15,88)
Pipe length range		m	5 - 50
Elevation difference (in / out) ⁷⁾		m	15 / 30
Pre-charged pipe length		m	30
Additional gas amount		g/m	45
Refrigerant (R32) / CO ₂ Eq.		kg / T	2,4 / 1,62
Operating range	Cool Min ~ Max	°C	-10 ~ +43
	Heat Min ~ Max	°C	-15 ~ +24

1) EER and COP calculation is based in accordance to EN14511. 2) For models below 12 kW, the SEER and SCOP is calculated based on values of EU/626/2011. For models above 12 kW, the $\eta_{h,c} / \eta_{h,h}$ values is calculated based on EN 14825. 3) Factory setting. 4) The sound pressure of the units shows the value measured of the position 1 m in front of the main body and 1 m below the unit. The sound pressure is measured in accordance with Eurovent 6/C/006-97 specification. 5) Connect the liquid socket tube (Ø6,35-Ø9,52) to the liquid tubing side indoor unit. 6) Connect the gas socket tube (Ø12,70-Ø15,88) to the gas tubing side indoor unit. 7) Outdoor unit located lower / outdoor unit located higher. * Recommended fuse for the indoor 3 A. ** Above values are in the case of nanoe™ X OFF.

Accessories

CZ-RTC6W	CONEX wired remote controller (non-wireless), white
CZ-RTC6WBL	CONEX wired remote controller with Bluetooth®, white
CZ-RTC6WBLW	CONEX wired remote controller with Wi-Fi and Bluetooth®, white
CZ-RTC6	CONEX wired remote controller (non-wireless), black
CZ-RTC6BL	CONEX wired remote controller with Bluetooth®, black
CZ-RTC6BLW	CONEX wired remote controller with Wi-Fi and Bluetooth®, black
CZ-RTC5B	Wired remote controller with Econavi function and datanavi
CZ-RWS3	Infrared remote controller

Accessories

CZ-CAPWFC1	Commercial Wi-Fi Adaptor
PAW-PACR4	Interface to run up to 4 indoor unit groups on backup and alternative run
PAW-WTRAY	Tray for condenser water compatible with outdoor elevation platform
PAW-GRDBSE20	Outdoor base ground support for noise and vibration absorption
PAW-GRDSTD40	Outdoor elevation platform 400x900x400 mm
CZ-CENSC1	Econavi energy saving sensor



SEER: For S-3650PK3E + U-36PZ3E5. SCOP: For S-6010PK3E + U-60PZ3E5A. INTERNET CONTROL: Optional.

Rating conditions: Cooling indoor 27 °C DB / 19 °C WB. Cooling outdoor 35 °C DB / 24 °C WB. Heating indoor 20 °C DB. Heating outdoor 7 °C DB / 6 °C WB. (DB: Dry Bulb; WB: Wet Bulb). Specifications subject to change without notice. For detailed information about ErP / Energy Labelling, please visit our websites www.aircon.panasonic.eu or www.ptc.panasonic.eu.

PACi NX Series Elite and Standard 4 way 60x60 cassette - PY3 - R32

- From 2,5 to 6,0 kW (4 capacity sizes)
- Maximum SEER: 7,3 A++ / SCOP: 4,7 A++*
- Built-in drain pump
- DC drain pump and float switch to reduce the noise
- nanoe™ X (Generator Mark 2: 9,6 trillion hydroxyl radicals/sec) as standard for better indoor air quality

* For Elite 3,6 KW model.



Elite			Single phase		
			3,6 kW	5,0 kW	6,0 kW
Kit			KIT-36PY3ZH5	KIT-50PY3ZH5	KIT-60PY3ZH5
Remote controller			CZ-RTC5B	CZ-RTC5B	CZ-RTC5B
Cooling capacity	Nominal (Min - Max)	kW	3,6(1,2 - 4,0)	5,0(1,2 - 5,6)	6,0(1,2 - 6,5)
EER ¹⁾	Nominal (Min - Max)	W/W	4,50(4,04 - 5,45)	3,76(3,41 - 5,45)	3,43(2,77 - 5,45)
SEER²⁾			7,3 A++	7,0 A++	6,7 A++
Pdesign		kW	3,6	5,0	6,0
Input power	Nominal (Min - Max)	kW	0,80(0,22 - 0,99)	1,33(0,22 - 1,64)	1,75(0,20 - 2,35)
Annual energy consumption ³⁾		kWh/a	400	685	875
Heating capacity	Nominal (Min - Max)	kW	4,0(1,2 - 5,0)	5,6(1,2 - 6,5)	7,0(1,2 - 7,5)
COP ¹⁾	Nominal (Min - Max)	W/W	4,12(3,45 - 5,45)	3,37(2,95 - 5,45)	3,35(3,38 - 5,45)
SCOP²⁾			4,7 A++	4,6 A++	4,3 A+
Pdesign at -10 °C		kW	3,6	4,5	4,6
Input power	Nominal (Min - Max)	kW	0,97(0,22 - 1,45)	1,66(0,22 - 2,20)	2,09(0,22 - 2,22)
Annual energy consumption ³⁾		kWh/a	1073	1370	1495
Indoor unit			S-36PY3E	S-50PY3E	S-60PY3E
Air flow	Hi / Med / Lo	m ³ /min	9,5/7,5/6,0	12,0/9,5/6,5	14,0/10,5/8,0
Moisture removal volume		L/h	1,5	2,5	2,8
Sound pressure ⁴⁾	Hi / Med / Lo	dB(A)	34/30/25	39/34/27	43/37/31
Sound power	Hi / Med / Lo	dB(A)	49/45/40	54/49/42	58/52/46
Dimension	Indoor (HxWxD)	mm	243x575x575	243x575x575	243x575x575
	Panel (HxWxD)	mm	30x625x625	30x625x625	30x625x625
Net weight	Indoor / Panel	kg	15/2,8	15/2,8	15/2,8
nanoe X Generator			Mark 2	Mark 2	Mark 2
Outdoor unit			U-36PZH3E5	U-50PZH3E5	U-60PZH3E5
Power supply		V	220 - 230 - 240	220 - 230 - 240	220 - 230 - 240
Current	Cool	A	3,95 - 3,60 - 3,60	5,30 - 5,00 - 5,75	8,20 - 7,85 - 7,60
	Heat	A	4,75 - 4,55 - 4,35	7,85 - 7,50 - 7,20	9,70 - 9,25 - 8,90
Air flow	Cool / Heat	m ³ /min	34,1/36,4	42,0/42,0	42,0/42,0
Sound pressure	Cool / Heat (Hi)	dB(A)	43/44	46/48	47/50
Sound power	Cool / Heat (Hi)	dB(A)	62/64	64/67	65/69
Dimension	HxWxD	mm	695x875x320	695x875x320	695x875x320
Net weight		kg	42	42	43
Piping diameter	Liquid	Inch (mm)	1/4 (6,35)	1/4 (6,35)	1/4 (6,35) ⁵⁾
	Gas	Inch (mm)	1/2(12,70)	1/2(12,70)	1/2(12,70) ⁶⁾
Pipe length range		m	3 - 40	3 - 40	3 - 40
Elevation difference (in / out) ⁷⁾		m	15/30	15/30	15/30
Pre-charged pipe length		m	30	30	30
Additional gas amount		g/m	15	15	15
Refrigerant (R32) / CO ₂ Eq.		kg / T	1,13/0,76	1,13/0,76	1,15/0,78
Operating range	Cool Min ~ Max	°C	-15 ~ +46	-15 ~ +46	-15 ~ +46
	Heat Min ~ Max	°C	-20 ~ +24	-20 ~ +24	-20 ~ +24

Compact and stylish design

- Required ceiling depth of only 250 mm
- Exposed area is only 30 mm

Individual flap control

Better control of the air flow with 4 motors, providing individual flap control. Perfect air distribution without direct airflow, to reduce the feeling of cold drafts.

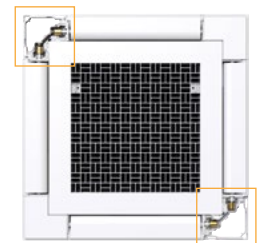

SEER and SCOP: For S-36PY3E + U-36PZH3E5. ECONAVI and INTERNET CONTROL: Optional.



CZ-RTC5B



Panel.
CZ-KPY4

COMPATIBLE WITH ALL PANASONIC CONNECTIVITY SOLUTIONS. FOR DETAILED INFORMATION GO TO THE CONTROL SYSTEMS SECTION

Optional:



CONEX wired remote controller, white. CZ-RTC6W/BL/BLW



CONEX wired remote controller, black. CZ-RTC6/BL/BLW



Infrared remote controller. CZ-RWS3 + CZ-RWRV3



Econavi sensor. CZ-CENSC1

Standard

Single phase

			2,5 kW	3,6 kW	5,0 kW	6,0 kW
Kit			KIT-25PY3Z5	KIT-36PY3Z5	KIT-50PY3Z5	KIT-60PY3Z5
Remote controller			CZ-RTC5B	CZ-RTC5B	CZ-RTC5B	CZ-RTC5B
Cooling capacity	Nominal (Min - Max)	kW	2,5 [1,5 - 3,9]	3,6 [1,5 - 4,0]	5,0 [1,5 - 5,6]	6,0 [2,0 - 7,0]
EER ¹⁾	Nominal (Min - Max)	W/W	4,46 [3,55 - 5,88]	3,96 [3,57 - 5,88]	3,50 [3,03 - 6,25]	3,39 [2,77 - 6,90]
SEER ²⁾			6,5 A++	6,7 A++	7,3 A++	6,8 A++
Pdesign		kW	2,5	3,6	5,0	6,0
Input power	Nominal (Min - Max)	kW	0,56 [0,26 - 1,10]	0,91 [0,26 - 1,12]	1,43 [0,24 - 1,85]	1,77 [0,29 - 2,53]
Annual energy consumption ³⁾		kWh/a	134	188	238	3,05
Heating capacity	Nominal (Min - Max)	kW	3,2 [1,5 - 4,6]	3,6 [1,5 - 4,6]	5,0 [1,5 - 6,4]	6,0 [1,8 - 7,0]
COP ¹⁾	Nominal (Min - Max)	W/W	4,44 [3,41 - 6,52]	4,29 [3,38 - 6,52]	3,94 [2,91 - 7,50]	3,61 [2,86 - 7,60]
SCOP ²⁾			4,6 A++	4,3 A+	4,4 A+	4,2 A+
Pdesign at -10 °C		kW	2,8	2,8	4,0	4,6
Input power	Nominal (Min - Max)	kW	0,72 [0,23 - 1,35]	0,84 [0,23 - 1,36]	1,27 [0,20 - 2,20]	1,66 [0,24 - 2,45]
Annual energy consumption ³⁾		kWh/a	850	912	1264	1500
Indoor unit			S-25PY3E	S-36PY3E	S-50PY3E	S-60PY3E
Air flow	Hi / Med / Lo	m ³ /min	8,5/7,0/6,0	9,5/7,0/6,0	12,0/9,5/6,5	14,0/10,5/8,0
Moisture removal volume		L/h	0,7	1,5	2,3	2,8
Sound pressure ⁴⁾	Hi / Med / Lo	dB(A)	31/28/25	34/30/25	39/34/27	43/37/31
Sound power	Hi / Med / Lo	dB(A)	46/43/40	49/45/40	54/49/42	58/52/46
Dimension	Indoor (HxWxD)	mm	243x575x575	243x575x575	243x575x575	243x575x575
	Panel (HxWxD)	mm	30x625x625	30x625x625	30x625x625	30x625x625
Net weight	Indoor / Panel	kg	15/2,8	15/2,8	15/2,8	15/2,8
nanoe X Generator			Mark 2	Mark 2	Mark 2	Mark 2
Outdoor unit			U-25PZ3E5	U-36PZ3E5	U-50PZ3E5	U-60PZ3E5A
Power supply		V	220 - 230 - 240	220 - 230 - 240	220 - 230 - 240	220 - 230 - 240
Current	Cool	A	2,65 - 2,55 - 2,45	4,20 - 4,05 - 3,85	6,65 - 6,35 - 6,10	8,20 - 7,85 - 7,55
	Heat	A	3,40 - 3,25 - 3,10	3,95 - 3,75 - 3,60	5,695 - 5,70 - 5,45	7,70 - 7,35 - 7,05
Air flow	Cool / Heat	m ³ /min	33,6/34,0	32,6/34,0	32,7/31,9	42,6/41,5
Sound pressure	Cool / Heat (Hi)	dB(A)	46/47	46/47	46/48	47/48
Sound power	Cool / Heat (Hi)	dB(A)	64/66	64/66	64/64	64/65
Dimension	H x W x D	mm	619 x 824 x 299	619 x 824 x 299	619 x 824 x 299	695 x 875 x 320
Net weight		kg	32	32	35	46
Piping diameter	Liquid	Inch (mm)	1/4 (6,35)	1/4 (6,35)	1/4 (6,35)	1/4 (6,35) ⁵⁾
	Gas	Inch (mm)	1/2 (12,70)	1/2 (12,70)	1/2 (12,70)	1/2 (12,70) ⁶⁾
Pipe length range		m	3 - 15	3 - 15	3 - 20	3 - 40
Elevation difference (in / out) ⁷⁾		m	15/15	15/15	15/15	15/30
Pre-charged pipe length		m	7,5	7,5	7,5	30
Additional gas amount		g/m	10	10	15	15
Refrigerant (R32) / CO ₂ Eq.		kg / T	0,87/0,59	0,87/0,59	1,14/0,77	1,15/0,78
Operating range	Cool Min ~ Max	°C	-10 ~ +43	-10 ~ +43	-10 ~ +43	-10 ~ +43
	Heat Min ~ Max	°C	-15 ~ +24	-15 ~ +24	-15 ~ +24	-15 ~ +24

1) EER and COP calculation is based in accordance to EN14511. 2) For models below 12 kW, the SEER and SCOP is calculated based on values of EU/626/2011. For models above 12 kW, the $\eta_{s,c}$ / $\eta_{s,h}$ values is calculated based on EN 14825. 3) Factory setting. 4) The sound pressure of the units shows the value measured of the position 1,5 m below the unit. The sound pressure is measured in accordance with Eurovent 6/C/006-97 specification. 5) Connect the liquid socket tube (Ø6,35-Ø9,52) to the liquid tubing side indoor unit. 6) Connect the gas socket tube (Ø12,70-Ø15,88) to the gas tubing side indoor unit. 7) Outdoor unit located lower / outdoor unit located higher. * Recommended fuse for the indoor 3 A. ** Above values are in the case of nanoe™ X OFF.

Accessories

CZ-RTC6W	CONEX wired remote controller (non-wireless), white
CZ-RTC6WBL	CONEX wired remote controller with Bluetooth®, white
CZ-RTC6WBLW	CONEX wired remote controller with Wi-Fi and Bluetooth®, white
CZ-RTC6	CONEX wired remote controller (non-wireless), black
CZ-RTC6BL	CONEX wired remote controller with Bluetooth®, black
CZ-RTC6BLW	CONEX wired remote controller with Wi-Fi and Bluetooth®, black
CZ-RTC5B	Wired remote controller with Econavi function and datanavi
CZ-RWS3 + CZ-RWRV3	Infrared remote controller and receiver

Accessories

CZ-CAPWFC1	Commercial Wi-Fi Adaptor
PAW-PACR4	Interface to run up to 4 indoor unit groups on backup and alternative run
PAW-WTRAY	Tray for condenser water compatible with outdoor elevation platform
PAW-GRDBSE20	Outdoor base ground support for noise and vibration absorption
PAW-GRDSTD40	Outdoor elevation platform 400 x 900 x 400 mm
CZ-CENSC1	Econavi energy saving sensor

SEER: For S-50PY3E + U-50PZ3E5. SCOP: For S-25PY3E + U-25PZ3E5. ECONAVI and INTERNET CONTROL: Optional.

Rating conditions: Cooling indoor 27 °C DB / 19 °C WB. Cooling outdoor 35 °C DB / 24 °C WB. Heating indoor 20 °C DB. Heating outdoor 7 °C DB / 6 °C WB. (DB: Dry Bulb; WB: Wet Bulb). Specifications subject to change without notice. For detailed information about ErP / Energy Labelling, please visit our websites www.aircon.panasonic.eu or www.ptc.panasonic.eu.

PACi NX Series Elite 4 way 90x90 cassette - PU3 - R32

4 way 90x90 cassette - PU3.

Powerful turbo fan and intelligent Econavi sensor ensure high energy efficiency, and nanoe™ X, which is equipped as standard, provides an exceptional level of indoor air quality.



			Single phase							
			3,6 kW	5,0 kW	6,0 kW	7,1 kW	10,0 kW	12,5 kW	14,0 kW	
Kit			KIT-36PU3ZH5	KIT-50PU3ZH5	KIT-60PU3ZH5	KIT-71PU3ZH45	KIT-100PU3ZH45	KIT-125PU3ZH45	KIT-140PU3ZH45	
Remote controller			CZ-RTC5B	CZ-RTC5B	CZ-RTC5B	CZ-RTC5B	CZ-RTC5B	CZ-RTC5B	CZ-RTC5B	
Cooling capacity	Nominal (Min - Max)	kW	3,6(1,2 - 4,0)	5,0(1,2 - 5,6)	6,0(1,2 - 7,1)	7,1(2,2 - 9,0)	9,5(3,1 - 12,5)	12,5(3,2 - 14,0)	13,4(3,3 - 16,0)	
EER ¹⁾	Nominal (Min - Max)	W/W	5,45(4,60 - 5,45)	4,31(3,86 - 5,45)	4,05(3,02 - 5,45)	4,06(2,69 - 5,79)	4,42(3,42 - 5,34)	3,80(3,08 - 5,33)	3,60(2,74 - 5,32)	
SEER / η _{sc} ²⁾			8,9 A+++	8,6 A+++	8,0 A++	7,7 A++	7,8 A++	304,3%	286,6%	
Pdesign	kW		3,6	5,0	6,0	7,1	9,5	12,5	13,4	
Input power	Nominal (Min - Max)	kW	0,66(0,22 - 0,87)	1,16(0,22 - 1,45)	1,48(0,22 - 2,35)	1,75(0,38 - 3,35)	2,15(0,58 - 3,65)	3,29(0,60 - 4,55)	3,72(0,62 - 5,85)	
Annual energy consumption ³⁾	kWh/a		142	203	263	323	426	—	—	
Heating capacity	Nominal (Min - Max)	kW	4,0(1,2 - 5,0)	5,6(1,2 - 6,5)	7,0(1,2 - 8,0)	8,0(2,0 - 9,0)	11,2(3,1 - 14,0)	14,0(3,2 - 16,0)	16,0(3,3 - 18,0)	
COP ¹⁾	Nominal (Min - Max)	W/W	5,41(4,55 - 5,45)	4,24(4,19 - 5,45)	4,02(3,40 - 5,45)	4,30(3,16 - 5,56)	5,00(3,64 - 5,54)	4,61(3,37 - 5,52)	4,30(3,27 - 5,50)	
SCOP / η _{sh} ²⁾			5,1 A+++	4,9 A++	4,8 A++	4,8 A++	4,9 A++	186,0%	181,2%	
Pdesign at -10 °C	kW		3,6	4,5	4,7	5,2	8,0	9,5	10,6	
Input power	Nominal (Min - Max)	kW	0,74(0,22 - 1,10)	1,32(0,22 - 1,55)	1,74(0,22 - 2,35)	1,86(0,36 - 2,85)	2,24(0,56 - 3,85)	3,04(0,58 - 4,75)	3,72(0,60 - 5,50)	
Annual energy consumption ³⁾	kWh/a		988	1286	1371	1517	2286	—	—	
Indoor unit			S-3650PU3E	S-3650PU3E	S-6071PU3E	S-6071PU3E	S-1014PU3E	S-1014PU3E	S-1014PU3E	
Air flow	Hi / Med / Lo	m ³ /min	14,5/13,0/11,5	16,5/13,5/11,5	21,0/16,0/13,0	22,0/16,0/13,0	36,0/26,0/18,0	37,0/27,0/19,0	38,0/29,0/20,0	
Moisture removal volume	L/h		0,7	1,6	1,7	2,5	1,9	4,8	4,9	
Sound pressure ⁴⁾	Hi / Med / Lo	dB(A)	30/28/27	32/29/27	36/31/28	37/31/28	45/38/32	46/39/33	47/40/34	
Sound power	Hi / Med / Lo	dB(A)	45/43/42	47/44/42	51/46/43	52/46/43	60/53/47	61/54/48	62/55/49	
Dimension	Indoor (H x W x D)	mm	256 x 840 x 840	256 x 840 x 840	256 x 840 x 840	256 x 840 x 840	319 x 840 x 840	319 x 840 x 840	319 x 840 x 840	
	Panel (H x W x D)	mm	33,5 x 950 x 950	33,5 x 950 x 950	33,5 x 950 x 950	33,5 x 950 x 950	33,5 x 950 x 950	33,5 x 950 x 950	33,5 x 950 x 950	
Net weight	Indoor / Panel	kg	19/5	19/5	20/5	20/5	25/5	25/5	25/5	
nanoe X Generator			Mark 1	Mark 1	Mark 1	Mark 1	Mark 1	Mark 1	Mark 1	
Outdoor unit			U-36PZH3E5	U-50PZH3E5	U-60PZH3E5	U-71PZH4E5	U-100PZH4E5	U-125PZH4E5	U-140PZH4E5	
Power supply	V		220 - 230 - 240	220 - 230 - 240	220 - 230 - 240	220 - 230 - 240	220 - 230 - 240	220 - 230 - 240	220 - 230 - 240	
Current	Cool	A	3,25 - 3,10 - 3,00	5,50 - 5,25 - 5,05	6,95 - 6,65 - 6,35	8,85 - 8,45 - 8,10	10,06 - 10,02 - 9,75	16,10 - 15,40 - 14,70	18,20 - 17,40 - 16,70	
	Heat	A	3,60 - 3,45 - 3,30	6,25 - 6,00 - 5,75	8,05 - 7,70 - 7,40	9,40 - 9,00 - 8,60	10,90 - 10,60 - 10,10	14,90 - 14,20 - 13,60	18,20 - 17,40 - 16,70	
Air flow	Cool / Heat	m ³ /min	34,1/36,4	42,0/42,0	42,0/42,0	62,0/66,0	76,0/70,0	86,0/78,0	89,0/83,0	
Sound pressure	Cool / Heat (Hi)	dB(A)	43/44	46/48	47/50	48/50	52/52	55/55	56/56	
Sound power	Cool / Heat (Hi)	dB(A)	62/64	64/67	65/69	65/67	69/69	73/73	74/74	
Dimension	H x W x D	mm	695 x 875 x 320	695 x 875 x 320	695 x 875 x 320	996 x 980 x 370	996 x 980 x 370	996 x 980 x 370	996 x 980 x 370	
Net weight	kg		42	42	43	66	84	86	86	
Piping diameter	Liquid	Inch (mm)	1/4 (6,35)	1/4 (6,35)	1/4 (6,35) ⁵⁾	3/8 (9,52)	3/8 (9,52)	3/8 (9,52)	3/8 (9,52)	
	Gas	Inch (mm)	1/2 (12,70)	1/2 (12,70)	1/2 (12,70) ⁶⁾	5/8 (15,88)	5/8 (15,88)	5/8 (15,88)	5/8 (15,88)	
Pipe length range	m		3 - 40	3 - 40	3 - 40	5 - 60	5 - 100	5 - 100	5 - 100	
Elevation difference (in / out) ⁷⁾	m		15/30	15/30	15/30	15/30	15/30	15/30	15/30	
Pre-charged pipe length	m		30	30	30	30	30	30	30	
Additional gas amount	g/m		15	15	15	30	40	40	40	
Refrigerant (R32) / CO ₂ Eq.	kg / T		1,13/0,76	1,13/0,76	1,15/0,78	1,95/1,32	2,70/1,82	3,00/2,03	3,00/2,03	
Operating range	Cool Min - Max	°C	-15 ~ +46	-15 ~ +46	-15 ~ +46	-15 ~ +52	-20 ⁸⁾ ~ +52	-20 ⁸⁾ ~ +52	-20 ⁸⁾ ~ +52	
	Heat Min - Max	°C	-20 ~ +24	-20 ~ +24	-20 ~ +24	-20 ~ +24	-20 ~ +24	-20 ~ +24	-20 ~ +24	

Technical focus

- High performance turbo fan
- Econavi: An optional intelligent sensor to reduce waste of energy
- nanoe™ X (Generator Mark 1 = 4,8 trillion hydroxyl radicals/sec) as standard for better indoor air quality, indoor unit internal cleaning with nanoe™ X plus dry operation
- Lower noise in low fan operation
- Light weight, easy piping and integrated drain pump for quick installation
- Wired remote control CZ-RTC6WBL and CZ-RTC6BL allows easy system setting via Bluetooth®
- High volume fresh air input with optional air-intake plenum and chamber (CZ-FDU3+CZ-ATU2)



CZ-RTC5B



Standard panel.
CZ-KPU3W



Optional Econavi panel
(CZ-RTC5B is required).
CZ-KPU3AW

+ COMPATIBLE WITH ALL PANASONIC CONNECTIVITY SOLUTIONS. FOR DETAILED INFORMATION GO TO THE CONTROL SYSTEMS SECTION



New
2023

Optional:



CONEX wired remote controller, white.
CZ-RTC6W/BL/BLW



CONEX wired remote controller, black.
CZ-RTC6/BL/BLW



Infrared remote controller.
CZ-RWS3 + CZ-RWRU3W

Three phase

Kit	Three phase					
	7,1 kW	10,0 kW	12,5 kW	14,0 kW		
Remote controller	CZ-RTC5B					
Cooling capacity	Nominal (Min - Max) kW	7,1 [2,2 - 9,0]	9,5 [3,1 - 12,5]	12,5 [3,2 - 14,0]	13,4 [3,3 - 16,0]	
EER ¹⁾	Nominal (Min - Max) W/W	4,06 [2,69 - 5,79]	4,42 [3,42 - 5,34]	3,80 [3,08 - 5,33]	3,60 [2,74 - 5,32]	
SEER / η _{sc} ²⁾		7,7 A++	7,2 A++	303,0%	286,6%	
Pdesign	kW	7,1	9,5	12,5	13,4	
Input power	Nominal (Min - Max) kW	1,75 [0,38 - 3,35]	2,15 [0,58 - 3,65]	3,29 [0,60 - 4,55]	3,72 [0,62 - 5,85]	
Annual energy consumption ³⁾	kWh/a	323	426	—	—	
Heating capacity	Nominal (Min - Max) kW	8,0 [2,0 - 9,0]	11,2 [3,1 - 14,0]	14,0 [3,2 - 16,0]	16,0 [3,3 - 18,0]	
COP ¹⁾	Nominal (Min - Max) W/W	4,30 [3,16 - 5,56]	5,00 [3,64 - 5,54]	4,61 [3,37 - 5,52]	4,30 [3,27 - 5,50]	
SCOP / η _{sh} ²⁾		4,8 A++	4,9 A++	186,0%	181,1%	
Pdesign at -10 °C	kW	5,2	8,0	9,5	10,6	
Input power	Nominal (Min - Max) kW	1,86 [0,36 - 2,85]	2,24 [0,56 - 3,85]	3,04 [0,58 - 4,75]	3,72 [0,60 - 5,50]	
Annual energy consumption ³⁾	kWh/a	1517	2286	—	—	
Indoor unit		S-6071PU3E	S-1014PU3E	S-1014PU3E	S-1014PU3E	
Air flow	Hi / Med / Lo	m ³ /min	22,0 / 16,0 / 13,0	36,0 / 26,0 / 18,0	37,0 / 27,0 / 19,0	38,0 / 29,0 / 20,0
Moisture removal volume		L/h	2,5	1,9	4,8	4,9
Sound pressure ⁴⁾	Hi / Med / Lo	dB(A)	37 / 31 / 28	45 / 38 / 32	46 / 39 / 33	47 / 40 / 34
Sound power	Hi / Med / Lo	dB(A)	52 / 46 / 43	60 / 53 / 47	61 / 54 / 48	62 / 55 / 49
Dimension	Indoor (H x W x D)	mm	256 x 840 x 840	319 x 840 x 840	319 x 840 x 840	319 x 840 x 840
	Panel (H x W x D)	mm	33,5 x 950 x 950	33,5 x 950 x 950	33,5 x 950 x 950	33,5 x 950 x 950
Net weight	Indoor / Panel	kg	20 / 5	25 / 5	25 / 5	25 / 5
nanoe X Generator		Mark 1	Mark 1	Mark 1	Mark 1	
Outdoor unit		U-71PZH4E8	U-100PZH4E8	U-125PZH4E8	U-140PZH4E8	
Power supply		V	380 - 400 - 415	380 - 400 - 415	380 - 400 - 415	380 - 400 - 415
Current	Cool	A	2,95 - 2,80 - 2,70	3,60 - 3,40 - 3,25	5,45 - 5,15 - 5,00	6,15 - 5,85 - 5,65
	Heat	A	3,15 - 3,00 - 2,90	3,75 - 3,55 - 3,40	5,10 - 4,80 - 4,65	6,20 - 5,90 - 5,65
Air flow	Cool / Heat	m ³ /min	62,0 / 66,0	76,0 / 70,0	86,0 / 78,0	89,0 / 83,0
Sound pressure	Cool / Heat (Hi)	dB(A)	48 / 50	52 / 52	55 / 55	56 / 56
Sound power	Cool / Heat (Hi)	dB(A)	65 / 67	69 / 69	73 / 73	74 / 74
Dimension	H x W x D	mm	996 x 980 x 370	996 x 980 x 370	996 x 980 x 370	996 x 980 x 370
Net weight		kg	66	82	84	84
Piping diameter	Liquid	Inch (mm)	3/8 (9,52)	3/8 (9,52)	3/8 (9,52)	3/8 (9,52)
	Gas	Inch (mm)	5/8 (15,88)	5/8 (15,88)	5/8 (15,88)	5/8 (15,88)
Pipe length range		m	5 - 60	5 - 100	5 - 100	5 - 100
Elevation difference (in / out) ⁷⁾		m	15 / 30	15 / 30	15 / 30	15 / 30
Pre-charged pipe length		m	30	30	30	30
Additional gas amount		g/m	30	40	40	40
Refrigerant (R32) / CO ₂ Eq.		kg / T	1,95 / 1,32	2,70 / 1,82	3,00 / 2,03	3,00 / 2,03
Operating range	Cool Min ~ Max	°C	-15 ~ +52	-20 ⁸⁾ ~ +52	-20 ⁸⁾ ~ +52	-20 ⁸⁾ ~ +52
	Heat Min ~ Max	°C	-20 ~ +24	-20 ~ +24	-20 ~ +24	-20 ~ +24

1) EER and COP calculation is based in accordance to EN14511. 2) For models below 12 kW, the SEER and SCOP is calculated based on values of EU/626/2011. For models above 12 kW, the η_{sc} / η_{sh} values is calculated based on EN 14825. 3) Factory setting. 4) The sound pressure of the units shows the value measured of the position 1,5 m below the unit. The sound pressure is measured in accordance with Eurovent 6/C/006-97 specification. 5) Connect the liquid socket tube (Ø6,35-Ø9,52) to the liquid tubing side indoor unit. 6) Connect the gas socket tube (Ø12,70-Ø15,88) to the gas tubing side indoor unit. 7) Outdoor unit located lower / outdoor unit located higher. 8) Pipe length up to 30 m. * Recommended fuse for the indoor 3 A. ** Above values are in the case of nanoe™ X OFF.

Accessories

CZ-RTC6W	CONEX wired remote controller (non-wireless), white
CZ-RTC6WBL	CONEX wired remote controller with Bluetooth®, white
CZ-RTC6WBLW	CONEX wired remote controller with Wi-Fi and Bluetooth®, white
CZ-RTC6	CONEX wired remote controller (non-wireless), black
CZ-RTC6BL	CONEX wired remote controller with Bluetooth®, black
CZ-RTC6BLW	CONEX wired remote controller with Wi-Fi and Bluetooth®, black
CZ-RTC5B	Wired remote controller with Econavi function and datanavi
CZ-RWS3 + CZ-RWRU3W	Infrared remote controller and receiver

Accessories

CZ-CAPWFC1	Commercial Wi-Fi Adaptor
CZ-KPU3AW	Econavi exclusive panel
PAW-PACR4	Interface to run up to 4 indoor unit groups on backup and alternative run
PAW-WTRAY	Tray for condenser water compatible with outdoor elevation platform
PAW-GRDBSE20	Outdoor base ground support for noise and vibration absorption
PAW-GRDSTD40	Outdoor elevation platform 400 x 900 x 400 mm
CZ-FDU3+CZ-ATU2	Fresh air-intake kit



SEER and SCOP: For S-3650PU3E + U-36PZH3E5. ECONAVI and INTERNET CONTROL: Optional.

Rating conditions: Cooling indoor 27 °C DB / 19 °C WB. Cooling outdoor 35 °C DB / 24 °C WB. Heating indoor 20 °C DB. Heating outdoor 7 °C DB / 6 °C WB. (DB: Dry Bulb; WB: Wet Bulb). Specifications subject to change without notice. For detailed information about ErP / Energy Labelling, please visit our websites www.aircon.panasonic.eu or www.ptc.panasonic.eu.

PACi NX Series Standard 4 way 90x90 cassette - PU3 · R32

4 way 90x90 cassette - PU3.

Powerful turbo fan and intelligent Econavi sensor ensure high energy efficiency, and nanoe™ X, which is equipped as standard, provides an exceptional level of indoor air quality.



		Single phase							
		3,6 kW	5,0 kW	6,0 kW	7,1 kW	10,0 kW	12,5 kW	14,0 kW	
Kit		KIT-36PU3Z5	KIT-50PU3Z5	KIT-60PU3Z5	KIT-71PU3Z5	KIT-100PU3Z5	KIT-125PU3Z5	KIT-140PU3Z5	
Remote controller		CZ-RTC5B	CZ-RTC5B	CZ-RTC5B	CZ-RTC5B	CZ-RTC5B	CZ-RTC5B	CZ-RTC5B	
Cooling capacity	Nominal (Min - Max)	kW	3,6(1,5 - 4,0)	5,0(1,5 - 5,6)	6,0(2,0 - 7,1)	7,1(2,6 - 7,7)	10,0(3,0 - 11,5)	12,5(3,2 - 13,5)	14,0(3,3 - 15,0)
EER ¹⁾	Nominal (Min - Max)	W/W	4,34(5,88-3,81)	3,91(6,25-3,20)	3,73(6,90-3,01)	3,27(5,00-2,77)	3,82(2,88-5,36)	3,58(2,81-5,33)	3,23(2,73-5,32)
SEER / η_{sc}²⁾			8,1 A++	8,0 A++	7,8 A++	6,8 A++	6,8 A++	267,0%	257,0%
Pdesign		kW	3,6	5,0	6,0	7,1	10,0	12,5	14,0
Input power	Nominal (Min - Max)	kW	0,83(0,25-1,05)	1,28(0,24-1,75)	1,61(0,29-2,36)	2,17(0,52-2,78)	2,62(0,56-4,00)	3,49(0,60-4,80)	4,34(0,62-5,50)
Annual energy consumption ³⁾		kWh/a	156	219	269	365	515	—	—
Heating capacity	Nominal (Min - Max)	kW	3,6(1,5 - 4,6)	5,0(1,5 - 6,4)	6,0(1,8 - 7,0)	7,1(2,1 - 8,1)	10,0(3,0 - 14,0)	12,5(3,3 - 15,0)	14,0(3,4 - 16,0)
COP ¹⁾	Nominal (Min - Max)	W/W	5,07(4,32-6,52)	4,63(3,48-7,50)	4,48(3,18-7,50)	4,23(3,38-6,36)	4,93(3,59-5,36)	4,43(3,57-5,50)	4,18(3,33-5,48)
SCOP / η_{sh}²⁾			4,8 A++	4,7 A++	4,9 A++	4,6 A++	4,4 A+	157,0%	152,2%
Pdesign at -10 °C		kW	2,8	4,0	4,6	5,2	10,0	12,5	14,0 (at -7 °C)
Input power	Nominal (Min - Max)	kW	0,71(0,23-1,06)	1,08(0,20-1,84)	1,34(0,24-2,20)	1,68(0,33-2,40)	2,03(0,56-3,90)	2,82(0,60-4,20)	3,35(0,62-4,80)
Annual energy consumption ³⁾		kWh/a	817	1191	1314	1583	3182	—	—
Indoor unit			S-3650PU3E	S-3650PU3E	S-6071PU3E	S-6071PU3E	S-1014PU3E	S-1014PU3E	S-1014PU3E
Air flow	Hi / Med / Lo	m ³ /min	14,5/13,0/11,5	16,5/13,5/11,5	21,0/16,0/13,0	22,0/16,0/13,0	36,0/26,0/18,0	37,0/27,0/19,0	38,0/29,0/20,0
Moisture removal volume		L/h	0,7	1,6	1,7	2,5	2,7	4,8	6,0
Sound pressure ⁴⁾	Hi / Med / Lo	dB(A)	30/28/27	32/29/27	36/31/28	37/31/28	45/38/32	46/39/33	47/40/34
Sound power	Hi / Med / Lo	dB(A)	45/43/42	47/44/42	51/46/43	52/46/43	60/53/47	61/54/48	62/55/49
Dimension	Indoor (HxWxD)	mm	256x840x840	256x840x840	256x840x840	256x840x840	319x840x840	319x840x840	319x840x840
	Panel (HxWxD)	mm	33,5x950x950	33,5x950x950	33,5x950x950	33,5x950x950	33,5x950x950	33,5x950x950	33,5x950x950
Net weight	Indoor / Panel	kg	19/5	19/5	20/5	20/5	25/5	25/5	25/5
nanoe X Generator			Mark 1	Mark 1	Mark 1	Mark 1	Mark 1	Mark 1	Mark 1
Outdoor unit			U-36PZ3E5	U-50PZ3E5	U-60PZ3E5A	U-71PZ3E5A	U-100PZ3E5	U-125PZ3E5	U-140PZ3E5
Power supply		V	220 - 230 - 240	220 - 230 - 240	220 - 230 - 240	220 - 230 - 240	220 - 230 - 240	220 - 230 - 240	220 - 230 - 240
Current	Cool	A	3,85 - 3,70 - 3,55	5,95 - 5,70 - 5,45	7,45 - 7,15 - 6,85	10,00 - 9,65 - 9,25	13,10 - 12,50 - 12,00	16,90 - 16,10 - 15,40	21,00 - 20,00 - 19,20
	Heat	A	3,35 - 3,20 - 3,05	5,05 - 4,85 - 4,65	6,20 - 5,95 - 5,70	7,80 - 7,45 - 7,15	10,10 - 9,70 - 9,30	13,60 - 13,00 - 12,50	16,20 - 15,50 - 14,80
Air flow	Cool / Heat	m ³ /min	33,6/34,0	32,7/31,9	42,6/41,5	44,7/45,9	73,0/73,0	82,0/80,0	84,0/82,0
Sound pressure	Cool / Heat (Hi)	dB(A)	46/47	46/46	47/48	48/49	52/52	55/55	56/56
Sound power	Cool / Heat (Hi)	dB(A)	64/66	64/64	64/65	66/68	70/70	73/73	74/74
Dimension	HxWxD	mm	619x824x299	619x824x299	695x875x320	695x875x320	996x980x370	996x980x370	996x980x370
Net weight		kg	32	35	42	50	83	87	87
Piping diameter	Liquid	Inch (mm)	1/4 (6,35)	1/4 (6,35)	1/4 (6,35) ⁵⁾	1/4 (6,35) ⁵⁾	3/8(9,52)	3/8(9,52)	3/8(9,52)
	Gas	Inch (mm)	1/2(12,70)	1/2(12,70)	1/2(12,70) ⁶⁾	5/8(15,88)	5/8(15,88)	5/8(15,88)	5/8(15,88)
Pipe length range		m	3~15	3~20	3~40	3~40	5~50	5~50	5~50
Elevation difference (in / out) ⁷⁾		m	15/15	15/15	15/30	20/30	15/30	15/30	15/30
Pre-charged pipe length		m	7,5	7,5	30	30	30	30	30
Additional gas amount		g/m	10	15	15	17	45	45	45
Refrigerant (R32) / CO ₂ Eq.		kg / T	0,87/0,59	1,14/0,77	1,15/0,78	1,32/0,89	2,40/1,62	2,80/1,89	2,80/1,89
Operating range	Cool Min - Max	°C	-10~+43	-10~+43	-10~+43	-10~+43	-10~+43	-10~+43	-10~+43
	Heat Min - Max	°C	-15~+24	-15~+24	-15~+24	-15~+24	-15~+24	-15~+24	-15~+24

Technical focus

- High performance turbo fan
- Econavi: An optional intelligent sensor to reduce waste of energy
- nanoe™ X (Generator Mark 1= 4,8 trillion hydroxyl radicals/sec) as standard for better indoor air quality, indoor unit internal cleaning with nanoe™ X plus dry operation
- Lower noise in low fan operation
- Light weight, easy piping and integrated drain pump for quick installation
- Wired remote control CZ-RTC6WBL and CZ-RTC6BL allows easy system setting via Bluetooth®
- High volume fresh air input with optional air-intake plenum and chamber (CZ-FDU3+CZ-ATU2)



CZ-RTC5B



Standard panel.
CZ-KPU3W



Optional Econavi panel
(CZ-RTC5B is required).
CZ-KPU3AW

COMPATIBLE WITH ALL PANASONIC CONNECTIVITY SOLUTIONS. FOR DETAILED INFORMATION GO TO THE CONTROL SYSTEMS SECTION

Optional:



CONEX wired remote controller, white. CZ-RTC6W/BL/BLW



CONEX wired remote controller, black. CZ-RTC6/BL/BLW



Infrared remote controller. CZ-RWS3 + CZ-RWRU3W



Kit	Three phase				
	10,0 kW	12,5 kW	14,0 kW		
Remote controller	KIT-100PU3Z8	KIT-125PU3Z8	KIT-140PU3Z8		
Cooling capacity	Nominal (Min - Max) kW	10,0(3,0 - 11,5)	12,5(3,2 - 13,5)	14,0(3,3 - 15,0)	
EER ¹⁾	Nominal (Min - Max) W/W	3,82(2,88 - 5,36)	3,58(2,81 - 5,33)	3,23(2,73 - 5,32)	
SEER / η _{s,c} ²⁾		6,7 A++	265,8%	256,2%	
Pdesign	kW	10,0	12,5	14,0	
Input power	Nominal (Min - Max) kW	2,62(0,56 - 4,00)	3,49(0,60 - 4,80)	4,34(0,62 - 5,50)	
Annual energy consumption ³⁾	kWh/a	521	—	—	
Heating capacity	Nominal (Min - Max) kW	10,0(3,0 - 14,0)	12,5(3,3 - 15,0)	14,0(3,4 - 16,0)	
COP ¹⁾	Nominal (Min - Max) W/W	4,93(3,59 - 5,36)	4,43(3,57 - 5,50)	4,18(3,33 - 5,48)	
SCOP / η _{s,h} ²⁾		4,4 A+	157,0%	152,2%	
Pdesign at -10 °C	kW	10,0	12,5	14,0 (at -7 °C)	
Input power	Nominal (Min - Max) kW	2,03(0,56 - 3,90)	2,82(0,60 - 4,20)	3,35(0,62 - 4,80)	
Annual energy consumption ³⁾	kWh/a	3182	—	—	
Indoor unit		S-1014PU3E	S-1014PU3E	S-1014PU3E	
Air flow	Hi / Med / Lo	m ³ /min	36,0/26,0/18,0	37,0/27,0/19,0	38,0/29,0/20,0
Moisture removal volume		L/h	2,7	4,8	6,0
Sound pressure ⁴⁾	Hi / Med / Lo	dB(A)	45/38/32	46/39/33	47/40/34
Sound power	Hi / Med / Lo	dB(A)	60/53/47	61/54/48	62/55/49
Dimension	Indoor (HxWxD)	mm	319 x 840 x 840	319 x 840 x 840	319 x 840 x 840
	Panel (HxWxD)	mm	33,5 x 950 x 950	33,5 x 950 x 950	33,5 x 950 x 950
Net weight	Indoor / Panel	kg	25/5	25/5	25/5
nanoe X Generator		Mark 1	Mark 1	Mark 1	
Outdoor unit		U-100PZ3E8	U-125PZ3E8	U-140PZ3E8	
Power supply		V	380 - 400 - 415	380 - 400 - 415	380 - 400 - 415
Current	Cool	A	4,35 - 4,15 - 4,00	5,65 - 5,35 - 5,15	7,00 - 6,65 - 6,40
	Heat	A	3,40 - 3,20 - 3,10	4,55 - 4,35 - 4,15	5,40 - 5,15 - 4,95
Air flow	Cool / Heat	m ³ /min	73,0/73,0	82,0/80,0	84,0/82,0
Sound pressure	Cool / Heat (Hi)	dB(A)	52/52	55/55	56/56
Sound power	Cool / Heat (Hi)	dB(A)	70/70	73/73	74/74
Dimension	H x W x D	mm	996 x 980 x 370	996 x 980 x 370	996 x 980 x 370
Net weight		kg	83	87	87
Piping diameter	Liquid	Inch (mm)	3/8(9,52)	3/8(9,52)	3/8(9,52)
	Gas	Inch (mm)	5/8(15,88)	5/8(15,88)	5/8(15,88)
Pipe length range		m	5 - 50	5 - 50	5 - 50
Elevation difference (in / out) ⁷⁾		m	15/30	15/30	15/30
Pre-charged pipe length		m	30	30	30
Additional gas amount		g/m	45	45	45
Refrigerant (R32) / CO ₂ Eq.		kg / T	2,40/1,62	2,80/1,89	2,80/1,89
Operating range	Cool Min ~ Max	°C	-10 ~ +43	-10 ~ +43	-10 ~ +43
	Heat Min ~ Max	°C	-15 ~ +24	-15 ~ +24	-15 ~ +24

1) EER and COP calculation is based in accordance to EN14511. 2) For models below 12 kW, the SEER and SCOP is calculated based on values of EU/626/2011. For models above 12 kW, the η_{s,c} / η_{s,h} values is calculated based on EN 14825. 3) Factory setting. 4) The sound pressure of the units shows the value measured of the position 1,5 m below the unit. The sound pressure is measured in accordance with Eurovent 6/C/006-97 specification. 5) Connect the liquid socket tube (Ø6,35-Ø9,52) to the liquid tubing side indoor unit. 6) Connect the gas socket tube (Ø12,70-Ø15,88) to the gas tubing side indoor unit. 7) Outdoor unit located lower / outdoor unit located higher. * Recommended fuse for the indoor 3 A. ** Above values are in the case of nanoe™ X OFF.

Accessories

CZ-RTC6W	CONEX wired remote controller (non-wireless), white
CZ-RTC6WBL	CONEX wired remote controller with Bluetooth®, white
CZ-RTC6WBLW	CONEX wired remote controller with Wi-Fi and Bluetooth®, white
CZ-RTC6	CONEX wired remote controller (non-wireless), black
CZ-RTC6BL	CONEX wired remote controller with Bluetooth®, black
CZ-RTC6BLW	CONEX wired remote controller with Wi-Fi and Bluetooth®, black
CZ-RTC5B	Wired remote controller with Econavi function and datanavi
CZ-RWS3 + CZ-RWRU3W	Infrared remote controller and receiver

Accessories

CZ-CAPWFC1	Commercial Wi-Fi Adaptor
CZ-KPU3AW	Econavi exclusive panel
PAW-PACR4	Interface to run up to 4 indoor unit groups on backup and alternative run
PAW-WTRAY	Tray for condenser water compatible with outdoor elevation platform
PAW-GRDBSE20	Outdoor base ground support for noise and vibration absorption
PAW-GRDSTD40	Outdoor elevation platform 400x900x400 mm
CZ-FDU3+CZ-ATU2	Fresh air-intake kit

SEER: For S-3650PU3E + U-36PZ3E5. SCOP: For S-6071PU3E + U-60PZ3E5A. ECONAVI and INTERNET CONTROL: Optional.

PACi NX Series Elite ceiling - PT3 · R32

Ceiling mounted units provide large and wide air distribution which is ideal for large rooms.

The height and depth of all capacities are the same for unified appearance in mixed installations.



			Single phase							
			3,6 kW	5,0 kW	6,0 kW	7,1 kW	10,0 kW	12,5 kW	14,0 kW	
Kit			KIT-36PT3ZH5	KIT-50PT3ZH5	KIT-60PT3ZH5	KIT-71PT3ZH45	KIT-100PT3ZH45	KIT-125PT3ZH45	KIT-140PT3ZH45	
Remote controller			CZ-RTC5B	CZ-RTC5B	CZ-RTC5B	CZ-RTC5B	CZ-RTC5B	CZ-RTC5B	CZ-RTC5B	
Cooling capacity	Nominal (Min - Max)	kW	3,5(1,2 - 4,0)	5,0(1,2 - 5,6)	6,0(1,2 - 7,1)	6,8(2,2 - 9,0)	9,5(3,1 - 12,5)	12,1(3,2 - 14,0)	13,4(3,3 - 16,0)	
EER ¹⁾	Nominal (Min - Max)	W/W	4,86(4,55 - 5,45)	4,03(3,57 - 5,45)	3,82(3,02 - 5,45)	3,91(2,69 - 5,79)	4,06(3,29 - 5,34)	3,46(3,01 - 5,33)	3,21(2,67 - 5,32)	
SEER / η _{sc} ²⁾			7,7 A++	7,4 A++	7,5 A++	7,3 A++	7,3 A++	278,4%	263,3%	
Pdesign			3,5	5,0	6,0	6,8	9,5	12,1	13,4	
Input power	Nominal (Min - Max)	kW	0,72(0,22 - 0,88)	1,24(0,22 - 1,57)	1,57(0,22 - 2,35)	1,74(0,38 - 3,35)	2,34(0,58 - 3,80)	3,50(0,60 - 4,65)	4,17(0,62 - 6,00)	
Annual energy consumption ³⁾			160	237	280	326	456	—	—	
Heating capacity	Nominal (Min - Max)	kW	4,0(1,2 - 5,0)	5,6(1,2 - 6,5)	7,0(1,2 - 8,0)	8,0(2,0 - 9,0)	11,2(3,1 - 14,0)	14,0(3,2 - 16,0)	16,0(3,3 - 18,0)	
COP ¹⁾	Nominal (Min - Max)	W/W	5,00(4,17 - 5,45)	4,03(3,94 - 5,45)	4,14(3,40 - 5,45)	3,96(3,16 - 5,56)	4,00(3,54 - 5,54)	3,78(3,20 - 5,52)	3,38(3,10 - 5,50)	
SCOP / η _{sh} ²⁾			4,9 A++	4,8 A++	4,8 A++	4,7 A++	4,5 A+	175,6%	169,3%	
Pdesign at -10 °C			3,1	4,0	4,6	4,7	7,8	9,5	10,2	
Input power	Nominal (Min - Max)	kW	0,80(0,22 - 1,20)	1,39(0,22 - 1,65)	1,69(0,22 - 2,35)	2,02(0,36 - 2,85)	2,80(0,56 - 3,95)	3,70(0,58 - 5,00)	4,74(0,62 - 5,80)	
Annual energy consumption ³⁾			886	1167	1342	1400	2426	—	—	
Indoor unit			S-3650PT3E	S-3650PT3E	S-6071PT3E	S-6071PT3E	S-1014PT3E	S-1014PT3E	S-1014PT3E	
Air flow	Hi / Med / Lo	m ³ /min	14,0/12,0/10,5	15,0/12,5/10,5	20,0/17,0/14,5	21,0/18,0/15,5	30,0/25,0/23,0	34,0/28,0/24,0	35,0/29,0/25,0	
Moisture removal volume			0,8	2,0	2,1	2,7	3,6	5,4	6,4	
Sound pressure ⁴⁾	Hi / Med / Lo	dB(A)	36/32/28	37/33/28	38/34/29	39/35/30	42/37/34	46/40/35	47/41/36	
Sound power	Hi / Med / Lo	dB(A)	54/50/46	55/51/46	56/52/47	57/53/48	60/55/52	64/58/53	65/59/54	
Dimension	HxWxD	mm	235x960x690	235x960x690	235x1275x690	235x1275x690	235x1590x690	235x1590x690	235x1590x690	
Net weight			26	26	34	34	40	40	40	
nanoe X Generator			Mark 2	Mark 2	Mark 2	Mark 2	Mark 2	Mark 2	Mark 2	
Outdoor unit			U-36PZH3E5	U-50PZH3E5	U-60PZH3E5	U-71PZH4E5	U-100PZH4E5	U-125PZH4E5	U-140PZH4E5	
Power supply			220 - 230 - 240	220 - 230 - 240	220 - 230 - 240	220 - 230 - 240	220 - 230 - 240	220 - 230 - 240	220 - 230 - 240	
Current	Cool	A	3,55 - 3,40 - 3,25	5,85 - 5,60 - 5,40	7,35 - 7,05 - 6,75	8,80 - 8,40 - 8,05	11,60 - 11,10 - 10,60	17,10 - 16,40 - 15,70	20,40 - 19,50 - 18,70	
	Heat	A	3,90 - 3,75 - 3,60	6,60 - 6,30 - 6,05	7,85 - 7,50 - 7,20	10,20 - 9,75 - 9,35	13,70 - 13,20 - 12,70	18,10 - 17,30 - 16,60	23,20 - 22,20 - 21,20	
Air flow	Cool / Heat	m ³ /min	34,1/36,4	42,0/42,0	42,0/42,0	62,0/66,0	76,0/70,0	86,0/78,0	89,0/83,0	
Sound pressure	Cool / Heat (Hi)	dB(A)	43/44	46/48	47/50	48/50	52/52	55/55	56/56	
Sound power	Cool / Heat (Hi)	dB(A)	62/64	64/67	65/69	65/67	69/69	73/73	74/74	
Dimension	HxWxD	mm	695x875x320	695x875x320	695x875x320	996x980x370	996x980x370	996x980x370	996x980x370	
Net weight			42	42	43	66	84	86	86	
Piping diameter	Liquid	Inch (mm)	1/4 (6,35)	1/4 (6,35)	1/4 (6,35) ⁵⁾	3/8 (9,52)	3/8 (9,52)	3/8 (9,52)	3/8 (9,52)	
	Gas	Inch (mm)	1/2 (12,70)	1/2 (12,70)	1/2 (12,70) ⁶⁾	5/8 (15,88)	5/8 (15,88)	5/8 (15,88)	5/8 (15,88)	
Pipe length range			3 - 40	3 - 40	3 - 40	5 - 60	5 - 100	5 - 100	5 - 100	
Elevation difference (in / out) ⁷⁾			15/30	15/30	15/30	15/30	15/30	15/30	15/30	
Pre-charged pipe length			30	30	30	30	30	30	30	
Additional gas amount			15	15	15	30	40	40	40	
Refrigerant (R32) / CO ₂ Eq.			1,13/0,76	1,13/0,76	1,15/0,78	1,95/1,32	2,70/1,82	3,00/2,03	3,00/2,03	
Operating range	Cool Min - Max	°C	-15 ~ +46	-15 ~ +46	-15 ~ +46	-15 ~ +52	-20 ⁸⁾ ~ +52	-20 ⁸⁾ ~ +52	-20 ⁸⁾ ~ +52	
	Heat Min - Max	°C	-20 ~ +24	-20 ~ +24	-20 ~ +24	-20 ~ +24	-20 ~ +24	-20 ~ +24	-20 ~ +24	

Technical focus

- Wide air distribution for large rooms
- Horizontal air flow reaches maximum 9,5 m
- Fresh air connection available on the unit
- Slim design with 235 mm height fits narrow space
- Silent operation
- nanoe™ X (Generator Mark 2: 9,6 trillion hydroxyl radicals/sec) as standard for better indoor air quality
- Wired remote control CZ-RTC6WBL and CZ-RTC6BL allows easy system setting via Bluetooth®
- Twin, Triple and Double-twin split options
- Easy connection and control of external fan or ERV using the connector PAW-FDC on the indoor unit PCB. The external device can be controlled by the remote control of the Panasonic indoor unit

Further comfort improvement with air flow distribution

Horizontal air flow reaches maximum 9,5 m. This is ideal for wide rooms.

The wide air discharge opening expands the air flow to the left and right. The unpleasant feeling caused when the air flow directly hits the human body is prevented by the "Draft prevention position", which changes the swing width, increasing the degree of comfort.

+ COMPATIBLE WITH ALL PANASONIC CONNECTIVITY SOLUTIONS. FOR DETAILED INFORMATION GO TO THE CONTROL SYSTEMS SECTION



CZ-RTC5B

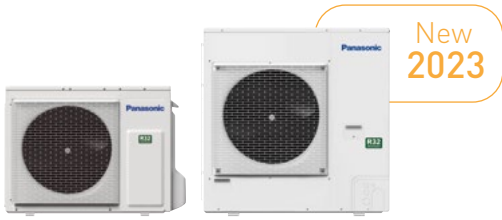

Optional:



CONEX wired remote controller, white. CZ-RTC6W/BL/BLW



CONEX wired remote controller, black. CZ-RTC6/BL/BLW



Infrared remote controller. CZ-RWS3 + CZ-RWRT3



Econavi sensor. CZ-CENSC1

Three phase

Kit			7,1 kW	10,0 kW	12,5 kW	14,0 kW
			KIT-71PT3ZH48	KIT-100PT3ZH48	KIT-125PT3ZH48	KIT-140PT3ZH48
Remote controller			CZ-RTC5B	CZ-RTC5B	CZ-RTC5B	CZ-RTC5B
Cooling capacity	Nominal (Min - Max)	kW	6,8[2,2 - 9,0]	9,5[3,1 - 12,5]	12,1[3,2 - 14,0]	13,4[3,3 - 16,0]
EER ¹⁾	Nominal (Min - Max)	W/W	3,91[2,69 - 5,79]	4,06[3,29 - 5,34]	3,46[3,01 - 5,33]	3,21[2,67 - 5,32]
SEER / η _{sc} ²⁾			7,2 A++	7,2 A++	277,3%	262,4%
Pdesign			6,8	9,5	12,1	13,4
Input power	Nominal (Min - Max)	kW	1,74[0,38 - 3,35]	2,34[0,58 - 3,80]	3,50[0,60 - 4,65]	4,17[0,66 - 6,00]
Annual energy consumption ³⁾			331	462	—	—
Heating capacity	Nominal (Min - Max)	kW	8,0[2,0 - 9,0]	11,2[3,1 - 14,0]	14,0[3,2 - 16,0]	16,0[3,3 - 18,0]
COP ¹⁾	Nominal (Min - Max)	W/W	3,96[3,16 - 5,56]	4,00[3,54 - 5,54]	3,78[3,20 - 5,52]	3,38[3,10 - 5,50]
SCOP / η _{sh} ²⁾			4,7 A++	4,5 A+	175,6%	169,3%
Pdesign at -10 °C			4,7	7,8	9,5	10,2
Input power	Nominal (Min - Max)	kW	2,02[0,36 - 2,85]	2,80[0,56 - 3,95]	3,70[0,58 - 5,00]	4,74[0,60 - 5,80]
Annual energy consumption ³⁾			1400	2427	—	—
Indoor unit			S-6071PT3E	S-1014PT3E	S-1014PT3E	S-1014PT3E
Air flow	Hi / Med / Lo	m ³ /min	21,0/18,0/15,5	30,0/25,0/23,0	34,0/28,0/24,0	35,0/29,0/25,0
Moisture removal volume			2,7	3,6	5,4	6,4
Sound pressure ⁴⁾	Hi / Med / Lo	dB(A)	39/35/30	42/37/34	46/40/35	47/41/36
Sound power	Hi / Med / Lo	dB(A)	57/53/48	60/55/52	64/58/53	65/59/54
Dimension	HxWxD	mm	235x1275x690	235x1590x690	235x1590x690	235x1590x690
Net weight			34	40	40	40
nanoe X Generator			Mark 2	Mark 2	Mark 2	Mark 2
Outdoor unit			U-71PZH4E8	U-100PZH4E8	U-125PZH4E8	U-140PZH4E8
Power supply			380 - 400 - 415	380 - 400 - 415	380 - 400 - 415	380 - 400 - 415
Current	Cool	A	2,95 - 2,80 - 2,70	3,60 - 3,40 - 3,25	5,45 - 5,15 - 5,00	6,15 - 5,85 - 5,65
	Heat	A	3,15 - 3,00 - 2,90	3,75 - 3,55 - 3,40	5,10 - 4,80 - 4,65	6,20 - 5,90 - 5,65
Air flow	Cool / Heat	m ³ /min	62,0/66,0	76,0/70,0	86,0/78,0	89,0/83,0
Sound pressure	Cool / Heat (Hi)	dB(A)	48/50	52/52	55/55	56/56
Sound power	Cool / Heat (Hi)	dB(A)	65/67	69/69	73/73	74/74
Dimension	HxWxD	mm	996x980x370	996x980x370	996x980x370	996x980x370
Net weight			66	82	84	84
Piping diameter	Liquid	Inch (mm)	3/8(9,52)	3/8(9,52)	3/8(9,52)	3/8(9,52)
	Gas	Inch (mm)	5/8(15,88)	5/8(15,88)	5/8(15,88)	5/8(15,88)
Pipe length range			5 - 60	5 - 100	5 - 100	5 - 100
Elevation difference (in / out) ⁷⁾			15/30	15/30	15/30	15/30
Pre-charged pipe length			30	30	30	30
Additional gas amount			30	40	40	40
Refrigerant (R32) / CO ₂ Eq.			1,95/1,32	2,70/1,82	3,00/2,03	3,00/2,03
Operating range	Cool Min ~ Max	°C	-15 ~ +52	-20 ⁸⁾ ~ +52	-20 ⁸⁾ ~ +52	-20 ⁸⁾ ~ +52
	Heat Min ~ Max	°C	-20 ~ +24	-20 ~ +24	-20 ~ +24	-20 ~ +24

1) EER and COP calculation is based in accordance to EN14511. 2) For models below 12 kW, the SEER and SCOP is calculated based on values of EU/626/2011. For models above 12 kW, the η_{sc} / η_{sh} values is calculated based on EN 14825. 3) Factory setting. 4) The sound pressure of the units shows the value measured of the position 1 m in front of the main body and 1 m below the unit. The sound pressure is measured in accordance with Eurovent 6/C/006-97 specification. 5) Connect the liquid socket tube (Ø6,35-Ø9,52) to the liquid tubing side indoor unit. 6) Connect the gas socket tube (Ø12,70-Ø15,88) to the gas tubing side indoor unit. 7) Outdoor unit located lower / outdoor unit located higher. 8) Pipe length up to 30 m. * Recommended fuse for the indoor 3 A. ** Above values are in the case of nanoe™ X OFF.

Accessories

CZ-RTC6W	CONEX wired remote controller (non-wireless), white
CZ-RTC6WBL	CONEX wired remote controller with Bluetooth®, white
CZ-RTC6WBLW	CONEX wired remote controller with Wi-Fi and Bluetooth®, white
CZ-RTC6	CONEX wired remote controller (non-wireless), black
CZ-RTC6BL	CONEX wired remote controller with Bluetooth®, black
CZ-RTC6BLW	CONEX wired remote controller with Wi-Fi and Bluetooth®, black
CZ-RTC5B	Wired remote controller with Econavi function and datanavi
CZ-RWS3 + CZ-RWRT3	Infrared remote controller

Accessories

CZ-CAPWFC1	Commercial Wi-Fi Adaptor
PAW-PACR4	Interface to run up to 4 indoor unit groups on backup and alternative run
PAW-WTRAY	Tray for condenser water compatible with outdoor elevation platform
PAW-GRDBSE20	Outdoor base ground support for noise and vibration absorption
PAW-GRDSTD40	Outdoor elevation platform 400x900x400 mm
CZ-CENSC1	Econavi energy saving sensor



SEER and SCOP: For S-3650PT3E + U-36PZH3E5. INTERNET CONTROL: Optional.

Rating conditions: Cooling indoor 27 °C DB / 19 °C WB. Cooling outdoor 35 °C DB / 24 °C WB. Heating indoor 20 °C DB. Heating outdoor 7 °C DB / 6 °C WB. (DB: Dry Bulb; WB: Wet Bulb). Specifications subject to change without notice. For detailed information about ErP / Energy Labelling, please visit our websites www.aircon.panasonic.eu or www.ptc.panasonic.eu.

PACi NX Series Standard ceiling - PT3 · R32

Ceiling mounted units provide large and wide air distribution which is ideal for large rooms.

The height and depth of all capacities are the same for unified appearance in mixed installations.



			Single phase							
Kit			3,6 kW	5,0 kW	6,0 kW	7,1 kW	10,0 kW	12,5 kW	14,0 kW	
Remote controller			KIT-36PT3Z5	KIT-50PT3Z5	KIT-60PT3Z5	KIT-71PT3Z5	KIT-100PT3Z5	KIT-125PT3Z5	KIT-140PT3Z5	
			CZ-RTC5B	CZ-RTC5B	CZ-RTC5B	CZ-RTC5B	CZ-RTC5B	CZ-RTC5B	CZ-RTC5B	
Cooling capacity	Nominal (Min - Max)	kW	3,5(1,5 - 4,0)	5,0(1,5 - 5,2)	6,0(2,0 - 7,1)	6,8(2,6 - 7,7)	10,0(3,0 - 11,5)	12,5(3,2 - 13,5)	14,0(3,3 - 15,0)	
EER ¹⁾	Nominal (Min - Max)	W/W	4,14(3,69 - 5,17)	3,03(2,86 - 5,00)	3,59(2,90 - 6,90)	3,24(2,75 - 4,91)	3,64(2,80 - 5,36)	3,32(2,77 - 5,33)	2,98(2,73 - 5,32)	
SEER / η _{sc} ²⁾			7,2 A++	6,7 A++	7,3 A++	5,9 A+	6,6 A++	241,7%	228,8%	
Pdesign		kW	3,5	5,0	6,0	6,8	10,0	12,5	14,0	
Input power	Nominal (Min - Max)	kW	0,85(0,29 - 1,10)	1,65(0,30 - 1,82)	1,67(0,29 - 2,45)	2,10(0,53 - 2,80)	2,75(0,56 - 4,10)	3,76(0,60 - 4,88)	4,70(0,62 - 5,50)	
Annual energy consumption ³⁾		kWh/a	171	262	288	404	531	—	—	
Heating capacity	Nominal (Min - Max)	kW	3,5(1,5 - 4,6)	5,0(1,5 - 6,4)	6,0(1,8 - 7,0)	6,8(2,1 - 8,1)	10,0(3,0 - 14,0)	12,5(3,3 - 15,0)	14,0(3,4 - 16,0)	
COP ¹⁾	Nominal (Min - Max)	W/W	4,61(3,51 - 5,70)	3,73(3,12 - 6,25)	4,11(2,92 - 6,67)	4,20(3,06 - 5,68)	4,24(3,30 - 5,36)	3,89(3,41 - 4,52)	3,70(3,08 - 5,48)	
SCOP / η _{sh} ²⁾			4,4 A+	4,1 A+	4,6 A++	4,3 A+	4,2 A+	147,4%	145,3%	
Pdesign at -10 °C		kW	2,8	4,0	4,6	4,7	10,0	12,5	13,6	
Input power	Nominal (Min - Max)	kW	0,76(0,26 - 1,31)	1,34(0,24 - 2,05)	1,46(0,27 - 2,40)	1,62(0,37 - 2,65)	2,36(0,56 - 4,00)	3,21(0,73 - 4,40)	3,78(0,62 - 5,20)	
Annual energy consumption ³⁾		kWh/a	891	1365	1399	1529	3331	—	—	
Indoor unit			S-3650PT3E	S-3650PT3E	S-6071PT3E	S-6071PT3E	S-1014PT3E	S-1014PT3E	S-1014PT3E	
Air flow	Hi / Med / Lo	m ³ /min	14,0/12,0/10,5	15,0/12,5/10,5	20,0/17,0/14,5	21,0/18,0/15,5	30,0/25,0/23,0	34,0/28,0/24,0	35,0/29,0/25,0	
Moisture removal volume		L/h	0,8	2,0	2,1	2,7	4,1	5,7	6,9	
Sound pressure ⁴⁾	Hi / Med / Lo	dB(A)	36/32/28	37/33/28	38/34/29	39/35/30	42/37/34	46/40/35	47/41/36	
Sound power	Hi / Med / Lo	dB(A)	54/50/46	55/51/46	56/52/47	57/53/48	60/55/52	64/58/53	65/59/54	
Dimension	HxWxD	mm	235x960x690	235x960x690	235x1275x690	235x1275x690	235x1590x690	235x1590x690	235x1590x690	
Net weight		kg	26	26	34	34	40	40	40	
nanoe X Generator			Mark 2	Mark 2	Mark 2	Mark 2	Mark 2	Mark 2	Mark 2	
Outdoor unit			U-36PZ3E5	U-50PZ3E5	U-60PZ3E5A	U-71PZ3E5A	U-100PZ3E5	U-125PZ3E5	U-140PZ3E5	
Power supply		V	220 - 230 - 240	220 - 230 - 240	220 - 230 - 240	220 - 230 - 240	220 - 230 - 240	220 - 230 - 240	220 - 230 - 240	
Current	Cool	A	3,90 - 3,75 - 3,60	7,65 - 7,30 - 7,00	7,75 - 7,40 - 7,10	9,75 - 9,30 - 8,95	13,70 - 13,10 - 12,60	18,20 - 17,40 - 16,70	22,70 - 21,70 - 20,80	
	Heat	A	3,55 - 3,40 - 3,25	6,30 - 6,00 - 5,75	6,75 - 6,50 - 6,20	7,50 - 7,20 - 6,90	11,80 - 11,30 - 10,80	15,50 - 14,80 - 14,20	18,30 - 17,50 - 16,80	
Air flow	Cool / Heat	m ³ /min	33,6/34,0	32,7/31,9	42,6/41,5	44,7/45,9	73,0/73,0	82,0/80,0	84,0/82,0	
Sound pressure	Cool / Heat (Hi)	dB(A)	46/47	46/46	47/48	48/49	52/52	55/55	56/56	
Sound power	Cool / Heat (Hi)	dB(A)	64/66	64/64	64/65	66/68	70/70	73/73	74/74	
Dimension	HxWxD	mm	619x824x299	619x824x299	695x875x320	695x875x320	996x980x370	996x980x370	996x980x370	
Net weight		kg	32	35	42	50	83	87	87	
Piping diameter	Liquid	Inch (mm)	1/4 (6,35)	1/4 (6,35)	1/4 (6,35) ⁵⁾	1/4 (6,35) ⁵⁾	3/8 (9,52)	3/8 (9,52)	3/8 (9,52)	
	Gas	Inch (mm)	1/2 (12,70)	1/2 (12,70)	1/2 (12,70) ⁶⁾	5/8 (15,88)	5/8 (15,88)	5/8 (15,88)	5/8 (15,88)	
Pipe length range		m	3 - 15	3 - 20	3 - 40	3 - 40	5 - 50	5 - 50	5 - 50	
Elevation difference (in / out) ⁷⁾		m	15/15	15/15	15/30	20/30	15/30	15/30	15/30	
Pre-charged pipe length		m	7,5	7,5	30	30	30	30	30	
Additional gas amount		g/m	10	15	15	17	45	45	45	
Refrigerant (R32) / CO ₂ Eq.		kg / T	0,87/0,59	1,14/0,77	1,15/0,78	1,32/0,89	2,40/1,62	2,80/1,89	2,80/1,89	
Operating range	Cool Min - Max	°C	-10 ~ +43	-10 ~ +43	-10 ~ +43	-10 ~ +43	-10 ~ +43	-10 ~ +43	-10 ~ +43	
	Heat Min - Max	°C	-15 ~ +24	-15 ~ +24	-15 ~ +24	-15 ~ +24	-15 ~ +24	-15 ~ +24	-15 ~ +24	

Technical focus

- Wide air distribution for large rooms
- Horizontal air flow reaches maximum 9,5 m
- Fresh air connection available on the unit
- Slim design with 235 mm height fits narrow space
- Silent operation
- nanoe™ X (Generator Mark 2: 9,6 trillion hydroxyl radicals/sec) as standard for better indoor air quality
- Wired remote control CZ-RTC6WBL and CZ-RTC6BL allows easy system setting via Bluetooth®
- Twin, Triple and Double-twin split options
- Easy connection and control of external fan or ERV using the connector PAW-FDC on the indoor unit PCB. The external device can be controlled by the remote control of the Panasonic indoor unit

Further comfort improvement with air flow distribution

Horizontal air flow reaches maximum 9,5 m. This is ideal for wide rooms.

The wide air discharge opening expands the air flow to the left and right. The unpleasant feeling caused when the air flow directly hits the human body is prevented by the "Draft prevention position", which changes the swing width, increasing the degree of comfort.

+ COMPATIBLE WITH ALL PANASONIC CONNECTIVITY SOLUTIONS. FOR DETAILED INFORMATION GO TO THE CONTROL SYSTEMS SECTION



CZ-RTC5B

Optional:

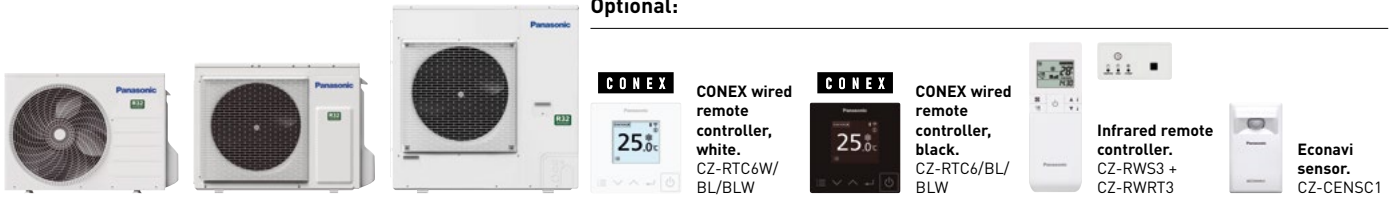

			Three phase		
			10,0 kW	12,5 kW	14,0 kW
Kit			KIT-100PT3Z8	KIT-125PT3Z8	KIT-140PT3Z8
Remote controller			CZ-RTC5B	CZ-RTC5B	CZ-RTC5B
Cooling capacity	Nominal (Min - Max)	kW	10,0(3,0 - 11,5)	12,5(3,2 - 13,5)	14,0(3,3 - 15,0)
EER ¹⁾	Nominal (Min - Max)	W/W	3,64(3,50 - 5,36)	3,32(2,77 - 5,33)	2,98(2,73 - 5,32)
SEER / η_{s,c} ²⁾			6,5 A++	241,7%	228,8%
Pdesign		kW	10,0	12,5	14,0
Input power	Nominal (Min - Max)	kW	2,75(0,56 - 4,10)	3,76(0,60 - 4,88)	4,70(0,62 - 5,50)
Annual energy consumption ³⁾		kWh/a	537	—	—
Heating capacity	Nominal (Min - Max)	kW	10,0(3,0 - 14,0)	12,5(3,3 - 15,0)	14,0(3,4 - 16,0)
COP ¹⁾	Nominal (Min - Max)	W/W	4,24(3,50 - 5,36)	3,89(3,41 - 4,52)	3,70(3,08 - 5,48)
SCOP / η_{s,h} ²⁾			4,2 A+	147,4%	145,3%
Pdesign at -10 °C		kW	10,0	12,5	13,6
Input power	Nominal (Min - Max)	kW	2,36(0,56 - 4,00)	3,21(0,73 - 4,40)	3,78(0,62 - 5,20)
Annual energy consumption ³⁾		kWh/a	3331	—	—
Indoor unit			S-1014PT3E	S-1014PT3E	S-1014PT3E
Air flow	Hi / Med / Lo	m ³ /min	30,0/25,0/23,0	34,0/28,0/24,0	35,0/29,0/25,0
Moisture removal volume		L/h	4,1	5,7	6,9
Sound pressure ⁴⁾	Hi / Med / Lo	dB(A)	42/37/34	46/40/35	47/41/36
Sound power	Hi / Med / Lo	dB(A)	60/55/52	64/58/53	65/59/54
Dimension	H x W x D	mm	235 x 1590 x 690	235 x 1590 x 690	235 x 1590 x 690
Net weight		kg	40	40	40
nanoe X Generator			Mark 2	Mark 2	Mark 2
Outdoor unit			U-100PZ3E8	U-125PZ3E8	U-140PZ3E8
Power supply		V	380 - 400 - 415	380 - 400 - 415	380 - 400 - 415
Current	Cool	A	4,60 - 4,35 - 4,20	6,10 - 5,75 - 5,55	7,60 - 7,20 - 6,95
	Heat	A	3,95 - 3,75 - 3,60	5,20 - 4,95 - 4,75	6,10 - 5,80 - 5,60
Air flow	Cool / Heat	m ³ /min	73,0/73,0	82,0/80,0	84,0/82,0
Sound pressure	Cool / Heat (Hi)	dB(A)	52/52	55/55	56/56
Sound power	Cool / Heat (Hi)	dB(A)	70/70	73/73	74/74
Dimension	H x W x D	mm	996 x 980 x 370	996 x 980 x 370	996 x 980 x 370
Net weight		kg	83	87	87
Piping diameter	Liquid	Inch (mm)	3/8(9,52)	3/8(9,52)	3/8(9,52)
	Gas	Inch (mm)	5/8(15,88)	5/8(15,88)	5/8(15,88)
Pipe length range		m	5 ~ 50	5 ~ 50	5 ~ 50
Elevation difference (in / out) ⁷⁾		m	15/30	15/30	15/30
Pre-charged pipe length		m	30	30	30
Additional gas amount		g/m	45	45	45
Refrigerant (R32) / CO ₂ Eq.		kg / T	2,40/1,62	2,8/1,89	2,8/1,89
Operating range	Cool Min ~ Max	°C	-10 ~ +43	-10 ~ +43	-10 ~ +43
	Heat Min ~ Max	°C	-15 ~ +24	-15 ~ +24	-15 ~ +24

1) EER and COP calculation is based in accordance to EN14511. 2) For models below 12 kW, the SEER and SCOP is calculated based on values of EU/626/2011. For models above 12 kW, the η_{s,c} / η_{s,h} values is calculated based on EN 14825. 3) Factory setting. 4) The sound pressure of the units shows the value measured of the position 1 m in front of the main body and 1 m below the unit. The sound pressure is measured in accordance with Eurovent 6/C/006-97 specification. 5) Connect the liquid socket tube (Ø6,35-Ø9,52) to the liquid tubing side indoor unit. 6) Connect the gas socket tube (Ø12,70-Ø15,88) to the gas tubing side indoor unit. 7) Outdoor unit located lower / outdoor unit located higher. * Recommended fuse for the indoor 3 A. ** Above values are in the case of nanoe™ X OFF.

Accessories

CZ-RTC6W	CONEX wired remote controller (non-wireless), white
CZ-RTC6WBL	CONEX wired remote controller with Bluetooth®, white
CZ-RTC6WBLW	CONEX wired remote controller with Wi-Fi and Bluetooth®, white
CZ-RTC6	CONEX wired remote controller (non-wireless), black
CZ-RTC6BL	CONEX wired remote controller with Bluetooth®, black
CZ-RTC6BLW	CONEX wired remote controller with Wi-Fi and Bluetooth®, black
CZ-RTC5B	Wired remote controller with Econavi function and datanavi
CZ-RWS3 + CZ-RWRT3	Infrared remote controller

Accessories

CZ-CAPWFC1	Commercial Wi-Fi Adaptor
PAW-PACR4	Interface to run up to 4 indoor unit groups on backup and alternative run
PAW-WTRAY	Tray for condenser water compatible with outdoor elevation platform
PAW-GRDBSE20	Outdoor base ground support for noise and vibration absorption
PAW-GRDSTD40	Outdoor elevation platform 400x900x400 mm
CZ-CENSC1	Econavi energy saving sensor



SEER and SCOP: For S-6071PT3E + U-60PZ3E8A. INTERNET CONTROL: Optional.

Rating conditions: Cooling indoor 27 °C DB / 19 °C WB. Cooling outdoor 35 °C DB / 24 °C WB. Heating indoor 20 °C DB. Heating outdoor 7 °C DB / 6 °C WB. (DB: Dry Bulb; WB: Wet Bulb). Specifications subject to change without notice. For detailed information about ErP / Energy Labelling, please visit our websites www.aircon.panasonic.eu or www.ptc.panasonic.eu.

PACi NX Series Elite adaptive ducted unit - PF3 · R32

Adaptive ducted unit - PF3.

2 installation possibilities (horizontal / vertical) with high ESP 150Pa allows flexible installation.



		Single phase							
		3,6 kW	5,0 kW	6,0 kW	7,1 kW	10,0 kW	12,5 kW	14,0 kW	
Kit		KIT-36PF3ZH5	KIT-50PF3ZH5	KIT-60PF3ZH5	KIT-71PF3ZH45	KIT-100PF3ZH45	KIT-125PF3ZH45	KIT-140PF3ZH45	
Remote controller		CZ-RTC5B	CZ-RTC5B	CZ-RTC5B	CZ-RTC5B	CZ-RTC5B	CZ-RTC5B	CZ-RTC5B	
Cooling capacity	Nominal (Min - Max)	kW	3,6(1,2 - 4,0)	5,0(1,2 - 5,6)	5,7(1,2 - 6,3)	6,8(2,2 - 7,8)	9,5(3,1 - 11,4)	12,1(3,2 - 13,6)	13,4(3,3 - 15,3)
EER ¹⁾	Nominal (Min - Max)	W/W	4,24(3,57 - 5,45)	3,42(3,11 - 5,45)	3,68(3,15 - 5,45)	3,74(2,41 - 5,64)	4,09(2,82 - 5,08)	3,53(3,00 - 5,00)	3,38(2,59 - 4,18)
SEER / η _{sc} ²⁾			6,8 A++	6,1 A++	7,1 A++	7,1 A++	7,4 A++	281,7%	275,9%
Pdesign		kW	3,6	5,0	5,7	6,8	9,5	12,1	13,4
Input power	Nominal (Min - Max)	kW	0,85(0,22 - 1,12)	1,46(0,22 - 1,80)	1,55(0,22 - 2,00)	1,82(0,39 - 3,24)	3,23(0,61 - 4,04)	3,43(0,64 - 4,54)	3,96(0,79 - 5,90)
Annual energy consumption ³⁾		kWh/a	185	287	281	332	447	—	—
Heating capacity	Nominal (Min - Max)	kW	4,0(1,2 - 5,0)	5,6(1,2 - 6,5)	7,0(1,2 - 8,0)	7,5(2,0 - 9,0)	10,8(3,1 - 13,5)	13,5(3,2 - 15,4)	15,5(3,3 - 17,4)
COP ¹⁾	Nominal (Min - Max)	W/W	4,17(3,23 - 5,45)	3,61(2,97 - 5,45)	3,74(3,33 - 5,45)	4,03(3,16 - 5,41)	3,88(3,07 - 5,25)	3,46(3,06 - 5,16)	3,33(3,14 - 4,29)
SCOP / η _{sh} ²⁾			4,5 A+	4,2 A+	4,4 A+	4,7 A++	4,3 A+	165,0%	162,6%
Pdesign at -10 °C		kW	3,6	4,0	4,7	4,7	7,8	9,3	9,5
Input power	Nominal (Min - Max)	kW	0,96(0,22 - 1,55)	1,55(0,22 - 2,19)	1,87(0,22 - 2,40)	1,86(0,37 - 2,85)	2,78(0,59 - 4,40)	3,90(0,62 - 5,04)	4,65(0,77 - 5,55)
Annual energy consumption ³⁾		kWh/a	1120	1333	1495	1393	2540	—	—
Indoor unit			S-3650PF3E	S-3650PF3E	S-6071PF3E	S-6071PF3E	S-1014PF3E	S-1014PF3E	S-1014PF3E
External static pressure ⁴⁾	Nominal (Min - Max)	Pa	30(10 - 150)	30(10 - 150)	30(10 - 150)	30(10 - 150)	40(10 - 150)	50(10 - 150)	50(10 - 150)
Air flow	Hi / Med / Lo	m ³ /min	14,0/13,0/10,0	16,0/15,0/12,0	21,0/19,0/15,0	21,0/19,0/15,0	20,0/26,0/21,0	34,0/29,0/23,0	36,0/32,0/25,0
Moisture removal volume		L/h	0,9	1,9	1,7	2,7	3,2	4,1	4,9
Sound pressure ⁵⁾	Hi / Med / Lo	dB(A)	30/27/22	34/30/25	30/26/23	30/26/23	33/29/25	35/31/27	39/35/29
Sound power	Hi / Med / Lo	dB(A)	53/50/45	57/53/48	53/49/46	53/49/46	56/52/48	58/54/50	62/58/52
Dimension	HxWxD	mm	250x800x730	250x800x730	250x1000x730	250x1000x730	250x1400x730	250x1400x730	250x1400x730
Net weight		kg	25	25	30	30	39	39	39
nanoex X Generator			Mark 2	Mark 2	Mark 2	Mark 2	Mark 2	Mark 2	Mark 2
Outdoor unit			U-36PZH3E5	U-50PZH3E5	U-60PZH3E5	U-71PZH4E5	U-100PZH4E5	U-125PZH4E5	U-140PZH4E5
Power supply		V	220 - 230 - 240	220 - 230 - 240	220 - 230 - 240	220 - 230 - 240	220 - 230 - 240	220 - 230 - 240	220 - 230 - 240
Current	Cool	A	4,20 - 4,00 - 3,85	6,90 - 6,60 - 6,35	7,25 - 6,95 - 6,65	9,20 - 8,80 - 8,45	11,50 - 11,00 - 10,50	16,80 - 16,00 - 15,40	19,40 - 18,50 - 17,70
	Heat	A	4,70 - 4,50 - 4,30	7,35 - 7,00 - 6,75	8,65 - 8,30 - 7,95	9,40 - 9,00 - 8,60	13,60 - 13,10 - 12,60	19,10 - 18,20 - 17,50	22,70 - 21,70 - 20,80
Air flow	Cool / Heat	m ³ /min	34,1/36,4	42,0/42,0	42,0/42,0	62,0/66,0	76,0/70,0	86,0/78,0	89,0/83,0
Sound pressure	Cool / Heat (Hi)	dB(A)	43/44	46/48	47/50	48/50	52/52	55/55	56/56
Sound power	Cool / Heat (Hi)	dB(A)	62/64	64/67	65/69	65/67	69/69	73/73	74/74
Dimension	HxWxD	mm	695x875x320	695x875x320	695x875x320	996x980x370	996x980x370	996x980x370	996x980x370
Net weight		kg	42	42	43	66	84	86	86
Piping diameter	Liquid	Inch (mm)	1/4 (6,35)	1/4 (6,35)	1/4 (6,35) ⁶⁾	3/8 (9,52)	3/8 (9,52)	3/8 (9,52)	3/8 (9,52)
	Gas	Inch (mm)	1/2 (12,70)	1/2 (12,70)	1/2 (12,70) ⁷⁾	5/8 (15,88)	5/8 (15,88)	5/8 (15,88)	5/8 (15,88)
Pipe length range		m	3 - 40	3 - 40	3 - 40	5 - 60	5 - 100	5 - 100	5 - 100
Elevation difference (in / out) ⁸⁾		m	15/30	15/30	15/30	15/30	15/30	15/30	15/30
Pre-charged pipe length		m	30	30	30	30	30	30	30
Additional gas amount		g/m	15	15	15	30	40	40	40
Refrigerant (R32) / CO ₂ Eq.		kg / T	1,13/0,76	1,13/0,76	1,15/0,78	1,95/1,32	2,70/1,82	3,00/2,03	3,00/2,03
Operating range	Cool Min - Max	°C	-15 ~ +46	-15 ~ +46	-15 ~ +46	-15 ~ +52	-20 ⁹⁾ ~ +52	-20 ⁹⁾ ~ +52	-20 ⁹⁾ ~ +52
	Heat Min - Max	°C	-20 ~ +24	-20 ~ +24	-20 ~ +24	-20 ~ +24	-20 ~ +24	-20 ~ +24	-20 ~ +24

Technical focus

- 2 installation possibilities (horizontal / vertical)
- Maximum external static pressure: 150 Pa
- Selectable inlet air position (rear / bottom entry)
- Improved drain pan suitable for both horizontal / vertical installation
- Drain pump included
- nanoex™ X (Generator Mark 2: 9,6 trillion hydroxyl radicals/sec) as standard for the long duct piping case*
- Wired remote control CZ-RTC6WBL and CZ-RTC6BL allows easy system setting via Bluetooth®

* The performance of nanoex™ X air can be expected even by 10 m long duct by Panasonic internal survey.

2 installation possibilities (horizontal / vertical)

Vertical installation is available. ESP 150Pa, sufficient for remotely installing units away from the rooms.



Improved drain pan design

Drain pan is shared in both cases horizontal and vertical installation. No need to modify the unit.

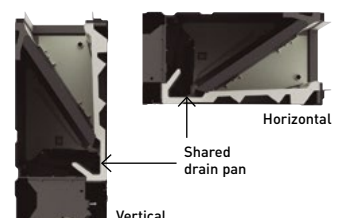

+ COMPATIBLE WITH ALL PANASONIC CONNECTIVITY SOLUTIONS. FOR DETAILED INFORMATION GO TO THE CONTROL SYSTEMS SECTION



CZ-RTC5B

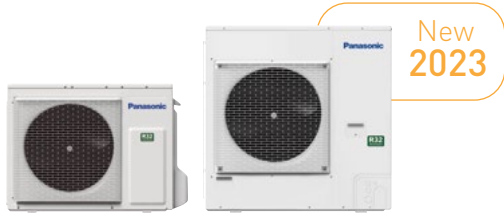

Optional:

CONEX



CONEX wired remote controller, white. CZ-RTC6W/BL/BLW

CONEX



CONEX wired remote controller, black. CZ-RTC6/BL/BLW



Infrared remote controller. CZ-RWS3 + CZ-RWRC3



Econavi sensor. CZ-CENSC1

Three phase

Kit	Three phase				
	7,1 kW	10,0 kW	12,5 kW	14,0 kW	
Remote controller	KIT-71PF3ZH48	KIT-100PF3ZH48	KIT-125PF3ZH48	KIT-140PF3ZH48	
Remote controller	CZ-RTC5B	CZ-RTC5B	CZ-RTC5B	CZ-RTC5B	
Cooling capacity	Nominal (Min - Max) kW	6,8[2,2 - 7,8]	9,5[3,1 - 11,4]	12,1[3,2 - 13,6]	13,4[3,3 - 15,3]
EER ¹⁾	Nominal (Min - Max) W/W	3,74[2,41 - 5,64]	4,09[2,82 - 5,08]	3,53[3,00 - 5,00]	3,38[2,59 - 4,18]
SEER / η_{sc} ²⁾		7,1 A++	7,4 A++	281,0%	275,2%
Pdesign	kW	6,8	9,5	12,1	13,4
Input power	Nominal (Min - Max) kW	1,82[0,39 - 3,24]	2,32[0,61 - 4,04]	3,43[0,64 - 4,54]	3,96[0,79 - 5,90]
Annual energy consumption ³⁾	kWh/a	332	447	—	—
Heating capacity	Nominal (Min - Max) kW	7,5[2,0 - 9,0]	10,8[3,1 - 13,5]	13,5[3,2 - 15,4]	15,5[3,3 - 17,4]
COP ¹⁾	Nominal (Min - Max) W/W	4,03[3,16 - 5,41]	3,88[3,07 - 5,25]	3,46[3,06 - 5,16]	3,33[3,14 - 4,29]
SCOP / η_{sh} ²⁾		4,7 A++	4,3 A+	165,0%	162,6%
Pdesign at -10 °C	kW	4,7	7,8	9,3	9,5
Input power	Nominal (Min - Max) kW	1,86[0,37 - 2,85]	2,78[0,59 - 4,40]	3,90[0,62 - 5,04]	4,65[0,77 - 5,55]
Annual energy consumption ³⁾	kWh/a	1394	2540	—	—
Indoor unit		S-6071PF3E	S-1014PF3E	S-1014PF3E	S-1014PF3E
External static pressure ⁴⁾	Nominal (Min - Max) Pa	30[10 - 150]	40[10 - 150]	50[10 - 150]	50[10 - 150]
Air flow	Hi / Med / Lo m ³ /min	21,0/19,0/15,0	32,0/26,0/21,0	34,0/29,0/23,0	36,0/32,0/25,0
Moisture removal volume	L/h	2,7	3,2	4,1	4,9
Sound pressure ⁵⁾	Hi / Med / Lo dB(A)	30/26/23	33/29/25	35/31/27	39/35/29
Sound power	Hi / Med / Lo dB(A)	53/49/46	56/52/48	58/54/50	62/58/52
Dimension	H x W x D mm	250 x 1000 x 730	250 x 1400 x 730	250 x 1400 x 730	250 x 1400 x 730
Net weight	kg	30	39	39	39
nanoe X Generator		Mark 2	Mark 2	Mark 2	Mark 2
Outdoor unit		U-71PZH4E8	U-100PZH4E8	U-125PZH4E8	U-140PZH4E8
Power supply	V	380 - 400 - 415	380 - 400 - 415	380 - 400 - 415	380 - 400 - 415
Current	Cool A	3,05 - 2,90 - 2,80	3,85 - 3,70 - 3,50	5,65 - 5,40 - 5,20	6,55 - 6,20 - 6,00
	Heat A	3,15 - 3,00 - 2,90	4,65 - 4,40 - 4,20	6,50 - 6,20 - 5,95	7,75 - 7,40 - 7,05
Air flow	Cool / Heat m ³ /min	62,0/66,0	76,0/70,0	86,0/78,0	89,0/83,0
Sound pressure	Cool / Heat (Hi) dB(A)	48/50	52/52	55/55	56/56
Sound power	Cool / Heat (Hi) dB(A)	65/67	69/69	73/73	74/74
Dimension	H x W x D mm	996 x 980 x 370	996 x 980 x 370	996 x 980 x 370	996 x 980 x 370
Net weight	kg	66	82	84	84
Piping diameter	Liquid Inch (mm)	3/8(9,52)	3/8(9,52)	3/8(9,52)	3/8(9,52)
	Gas Inch (mm)	5/8(15,88)	5/8(15,88)	5/8(15,88)	5/8(15,88)
Pipe length range	m	5 - 60	5 - 100	5 - 100	5 - 100
Elevation difference (in / out) ⁸⁾	m	15/30	15/30	15/30	15/30
Pre-charged pipe length	m	30	30	30	30
Additional gas amount	g/m	30	40	40	40
Refrigerant (R32) / CO ₂ Eq.	kg / T	1,95/1,32	2,70/1,82	3,00/2,03	3,00/2,03
Operating range	Cool Min ~ Max °C	-15 ~ +52	-20 ⁹⁾ ~ +52	-20 ⁹⁾ ~ +52	-20 ⁹⁾ ~ +52
	Heat Min ~ Max °C	-20 ~ +24	-20 ~ +24	-20 ~ +24	-20 ~ +24

1) EER and COP calculation is based in accordance to EN14511. 2) For models below 12 kW, the SEER and SCOP is calculated based on values of EU/626/2011. For models above 12 kW, the η_{sc} / η_{sh} values is calculated based on EN 14825. 3) Factory setting. 4) Medium external static pressure setting from factory. 5) The sound pressure of the units shows the value measured of the position 1,5 m below the unit. The sound pressure is measured in accordance with Eurovent 6/C/006-97 specification. 6) Connect the liquid socket tube (Ø6,35-Ø9,52) to the liquid tubing side indoor unit. 7) Connect the gas socket tube (Ø12,70-Ø15,88) to the gas tubing side indoor unit. 8) Outdoor unit located lower / outdoor unit located higher. 9) Pipe length up to 30 m. * Recommended fuse for the indoor 3 A. ** Above values are in the case of standard installation(horizontal installation in the ceiling, rear side air intake) and nanoe™ X OFF.

Accessories

CZ-RTC6W	CONEX wired remote controller (non-wireless), white
CZ-RTC6WBL	CONEX wired remote controller with Bluetooth®, white
CZ-RTC6WBLW	CONEX wired remote controller with Wi-Fi and Bluetooth®, white
CZ-RTC6	CONEX wired remote controller (non-wireless), black
CZ-RTC6BL	CONEX wired remote controller with Bluetooth®, black
CZ-RTC6BLW	CONEX wired remote controller with Wi-Fi and Bluetooth®, black
CZ-RTC5B	Wired remote controller with Econavi function and datanavi
CZ-RWS3 + CZ-RWRC3	Infrared remote controller and receiver
CZ-CAPWFC1	Commercial Wi-Fi Adaptor

Accessories

PAW-PACR4	Interface to run up to 4 indoor unit groups on backup and alternative run
PAW-WTRAY	Tray for condenser water compatible with outdoor elevation platform
PAW-GRDBSE20	Outdoor base ground support for noise and vibration absorption
PAW-GRDSTD40	Outdoor elevation platform 400x900x400 mm
CZ-CENSC1	Econavi energy saving sensor
CZ-56DAF2	Air outlet plenum for S-3650PF3E
CZ-90DAF2	Air outlet plenum for S-6071PF3E
CZ-160DAF2	Air outlet plenum for S-1014PF3E



SEER and SCOP: For S-6071PF3E + U-71PZH4E5. SUPER QUIET: For S-3650PF3E + U-36PZH3E5. INTERNET CONTROL: Optional.

Rating conditions: Cooling indoor 27 °C DB / 19 °C WB. Cooling outdoor 35 °C DB / 24 °C WB. Heating indoor 20 °C DB. Heating outdoor 7 °C DB / 6 °C WB. (DB: Dry Bulb, WB: Wet Bulb). Specifications subject to change without notice. For detailed information about ErP / Energy Labelling, please visit our websites www.aircon.panasonic.eu or www.ptc.panasonic.eu.

PACi NX Series Standard adaptive ducted unit - PF3 · R32

Adaptive ducted unit - PF3.

2 installation possibilities (horizontal / vertical) with high ESP 150Pa allows flexible installation.



		Single phase							
Kit		3,6 kW	5,0 kW	6,0 kW	7,1 kW	10,0 kW	12,5 kW	14,0 kW	
Remote controller		KIT-36PF3Z5	KIT-50PF3Z5	KIT-60PF3Z5	KIT-71PF3Z5	KIT-100PF3Z5	KIT-125PF3Z5	KIT-140PF3Z5	
		CZ-RTC5B	CZ-RTC5B	CZ-RTC5B	CZ-RTC5B	CZ-RTC5B	CZ-RTC5B	CZ-RTC5B	
Cooling capacity	Nominal (Min - Max)	kW	3,4(1,5 - 4,0)	5,0(1,5 - 5,3)	5,7(2,0 - 6,3)	6,8(2,6 - 7,7)	9,5(3,0 - 11,4)	12,1(3,2 - 13,5)	13,4(3,3 - 15,0)
EER ¹⁾	Nominal (Min - Max)	W/W	3,78(3,51 - 5,00)	2,78(2,76 - 4,63)	3,54(2,63 - 5,88)	3,18(2,69 - 4,56)	3,57(2,36 - 5,08)	3,40(2,76 - 5,08)	3,16(2,56 - 5,08)
SEER / η _{sc} ²⁾			6,0 A+	6,5 A++	6,4 A++	6,0 A+	6,6 A++	257,4%	252,2%
Pdesign		kW	3,4	5,0	5,7	6,8	9,5	12,1	13,4
Input power	Nominal (Min - Max)	kW	0,90(0,30 - 1,14)	1,80(0,32 - 1,92)	1,61(0,34 - 2,40)	2,14(0,57 - 2,86)	2,66(0,59 - 4,84)	3,56(0,63 - 4,90)	4,24(0,65 - 5,86)
Annual energy consumption ³⁾		kWh/a	198	267	310	391	502	—	—
Heating capacity	Nominal (Min - Max)	kW	3,4(1,5 - 4,6)	5,0(1,5 - 5,9)	5,7(1,8 - 7,0)	6,8(2,1 - 8,1)	9,5(3,0 - 13,5)	12,1(3,3 - 15,0)	13,4(3,4 - 16,0)
COP ¹⁾	Nominal (Min - Max)	W/W	4,15(3,51 - 5,36)	3,62(3,06 - 5,36)	4,04(2,82 - 6,21)	4,00(3,03 - 5,68)	4,09(3,00 - 5,08)	3,56(3,16 - 5,24)	3,76(3,03 - 5,23)
SCOP / η _{sh} ²⁾			4,0 A+	4,0 A+	4,4 A+	4,1 A+	3,9 A	142,6%	140,6%
Pdesign at -10 °C		kW	2,4	3,8	4,4	4,7	7,8	9,3	9,5
Input power	Nominal (Min - Max)	kW	0,82(0,28 - 1,31)	1,38(0,28 - 1,73)	1,41(0,29 - 2,48)	1,70(0,37 - 2,67)	2,32(0,59 - 4,50)	3,40(0,63 - 4,74)	3,56(0,65 - 5,28)
Annual energy consumption ³⁾		kWh/a	839	1303	1376	1591	2795	—	—
Indoor unit			S-3650PF3E	S-3650PF3E	S-6071PF3E	S-6071PF3E	S-1014PF3E	S-1014PF3E	S-1014PF3E
External static pressure ⁴⁾	Nominal (Min - Max)	Pa	30(10 - 150)	30(10 - 150)	30(10 - 150)	30(10 - 150)	40(10 - 150)	50(10 - 150)	50(10 - 150)
Air flow	Hi / Med / Lo	m ³ /min	14,0/13,0/10,0	16,0/15,0/12,0	21,0/19,0/15,0	21,0/19,0/15,0	32,0/26,0/21,0	34,0/29,0/23,0	36,0/32,0/25,0
Moisture removal volume		L/h	0,9	1,9	1,7	2,7	3,2	4,1	4,9
Sound pressure ⁵⁾	Hi / Med / Lo	dB(A)	30/27/22	34/30/25	30/26/23	30/26/23	33/29/25	35/31/27	39/35/29
Sound power	Hi / Med / Lo	dB(A)	53/50/45	57/53/48	53/49/46	53/49/46	56/52/48	58/54/50	62/58/52
Dimension	HxWxD	mm	250x800x730	250x800x730	250x1000x730	250x1000x730	250x1400x730	250x1400x730	250x1400x730
Net weight		kg	25	25	30	30	39	39	39
nanoe X Generator			Mark 2	Mark 2	Mark 2	Mark 2	Mark 2	Mark 2	Mark 2
Outdoor unit			U-36PZ3E5	U-50PZ3E5	U-60PZ3E5A	U-71PZ3E5A	U-100PZ3E5	U-125PZ3E5	U-140PZ3E5
Power supply		V	220 - 230 - 240	220 - 230 - 240	220 - 230 - 240	220 - 230 - 240	220 - 230 - 240	220 - 230 - 240	220 - 230 - 240
Current	Cool	A	4,15 - 4,00 - 3,85	8,35 - 8,00 - 7,65	7,45 - 7,15 - 6,85	9,95 - 9,50 - 9,10	13,30 - 12,70 - 12,20	17,20 - 16,40 - 15,80	20,50 - 19,60 - 18,8
	Heat	A	3,85 - 3,70 - 3,50	6,45 - 6,20 - 5,95	6,55 - 6,25 - 6,00	7,90 - 7,55 - 7,25	11,60 - 11,10 - 10,60	16,40 - 15,70 - 15,00	17,20 - 16,40 - 15,80
Air flow	Cool / Heat	m ³ /min	33,6/34,0	32,7/31,9	42,6/41,5	44,7/45,9	73,0/73,0	82,0/80,0	84,0/82,0
Sound pressure	Cool / Heat (Hi)	dB(A)	46/47	46/46	47/48	48/49	52/52	55/55	56/56
Sound power	Cool / Heat (Hi)	dB(A)	64/66	64/64	64/65	66/68	70/70	73/73	74/74
Dimension	HxWxD	mm	619x824x299	619x824x299	695x875x320	695x875x320	996x980x370	996x980x370	996x980x370
Net weight		kg	32	35	42	50	83	87	87
Piping diameter	Liquid	Inch (mm)	1/4(Ø6,35)	1/4(Ø6,35)	1/4(Ø6,35) ⁶⁾	1/4(Ø6,35) ⁶⁾	3/8(9,52)	3/8(9,52)	3/8(9,52)
	Gas	Inch (mm)	1/2(Ø12,7)	1/2(Ø12,7)	1/2(Ø12,7) ⁷⁾	5/8(Ø15,88)	5/8(15,88)	5/8(15,88)	5/8(15,88)
Pipe length range		m	3 - 15	3 - 20	3 - 40	3 - 40	5 - 50	5 - 50	5 - 50
Elevation difference (in / out) ⁸⁾		m	15/15	15/15	15/30	20/30	15/30	15/30	15/30
Pre-charged pipe length		m	7,5	7,5	30	30	30	30	30
Additional gas amount		g/m	10	15	15	17	45	45	45
Refrigerant (R32) / CO ₂ Eq.		kg / T	0,87/0,59	1,14/0,77	1,15/0,78	1,32/0,89	2,40/1,62	2,80/1,89	2,80/1,89
Operating range	Cool Min - Max	°C	-10 ~ +43	-10 ~ +43	-10 ~ +43	-10 ~ +43	-10 ~ +43	-10 ~ +43	-10 ~ +43
	Heat Min - Max	°C	-15 ~ +24	-15 ~ +24	-15 ~ +24	-15 ~ +24	-15 ~ +24	-15 ~ +24	-15 ~ +24

Technical focus

- 2 installation possibilities (horizontal / vertical)
- Maximum external static pressure: 150 Pa
- Selectable inlet air position (rear / bottom entry)
- Improved drain pan suitable for both horizontal / vertical installation
- Drain pump included
- nanoe™ X (Generator Mark 2: 9,6 trillion hydroxyl radicals/sec) as standard for the long duct piping case*
- Wired remote control CZ-RTC6WBL and CZ-RTC6BL allows easy system setting via Bluetooth®

* The performance of nanoe™ X air can be expected even by 10 m long duct by Panasonic internal survey.

2 installation possibilities (horizontal / vertical)

Vertical installation is available. ESP 150Pa, sufficient for remotely installing units away from the rooms.



Improved drain pan design

Drain pan is shared in both cases horizontal and vertical installation. No need to modify the unit.

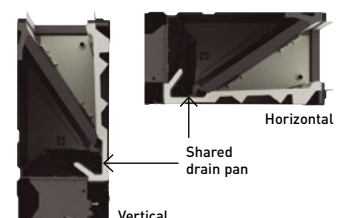



CZ-RTC5B

+ COMPATIBLE WITH ALL PANASONIC CONNECTIVITY SOLUTIONS. FOR DETAILED INFORMATION GO TO THE CONTROL SYSTEMS SECTION



Optional:

CONEX

CONEX wired remote controller, white. CZ-RTC6W/BL/BLW



CONEX

CONEX wired remote controller, black. CZ-RTC6/BL/BLW



Infrared remote controller. CZ-RWS3 + CZ-RWRC3



Econavi sensor. CZ-CENSC1

Kit			10,0 kW		Three phase		14,0 kW	
			KIT-100PF3Z8		KIT-125PF3Z8		KIT-140PF3Z8	
Remote controller		CZ-RTC5B		CZ-RTC5B		CZ-RTC5B		
Cooling capacity	Nominal (Min - Max)	kW	9,5(3,0 - 11,4)		12,1(3,2 - 13,5)		13,4(3,3 - 15,0)	
EER ¹⁾	Nominal (Min - Max)	W/W	3,57(2,36 - 5,08)		3,40(2,76 - 5,08)		3,16(2,56 - 5,08)	
SEER / η _{s,c} ²⁾			6,5 A++		256,2%		251,4%	
Pdesign		kW	9,5		12,1		13,4	
Input power	Nominal (Min - Max)	kW	2,66(0,59 - 4,84)		3,56(0,63 - 4,90)		4,24(0,65 - 5,86)	
Annual energy consumption ³⁾		kWh/a	508		—		—	
Heating capacity	Nominal (Min - Max)	kW	9,5(3,0 - 13,5)		12,1(3,3 - 15,0)		13,4(3,4 - 16,0)	
COP ¹⁾	Nominal (Min - Max)	W/W	4,09(3,00 - 5,08)		3,56(3,16 - 5,24)		3,76(3,03 - 5,23)	
SCOP / η _{s,h} ²⁾			3,9 A		142,6%		140,6%	
Pdesign at -10 °C		kW	7,8		9,3		9,5	
Input power	Nominal (Min - Max)	kW	2,32(0,59 - 4,50)		3,40(0,63 - 4,74)		3,56(0,65 - 5,28)	
Annual energy consumption ³⁾		kWh/a	2795		—		—	
Indoor unit			S-1014PF3E		S-1014PF3E		S-1014PF3E	
External static pressure ⁴⁾	Nominal (Min - Max)	Pa	40(10 - 150)		50(10 - 150)		50(10 - 150)	
Air flow	Hi / Med / Lo	m ³ /min	32,0/26,0/21,0		34,0/29,0/23,0		36,0/32,0/25,0	
Moisture removal volume		L/h	3,2		4,1		4,9	
Sound pressure ⁵⁾	Hi / Med / Lo	dB(A)	33/29/25		35/31/27		39/35/29	
Sound power	Hi / Med / Lo	dB(A)	56/52/48		58/54/50		62/58/52	
Dimension	H x W x D	mm	250 x 1400 x 730		250 x 1400 x 730		250 x 1400 x 730	
Net weight		kg	39		39		39	
nanoe X Generator			Mark 2		Mark 2		Mark 2	
Outdoor unit			U-100PZ3E8		U-125PZ3E8		U-140PZ3E8	
Power supply		V	380 - 400 - 415		380 - 400 - 415		380 - 400 - 415	
Current	Cool	A	4,45 - 4,20 - 4,05		5,75 - 5,45 - 5,25		6,85 - 6,50 - 6,30	
	Heat	A	3,85 - 3,70 - 3,55		5,50 - 5,20 - 5,05		5,75 - 5,45 - 5,25	
Air flow	Cool / Heat	m ³ /min	73,0/73,0		82,0/80,0		84,0/82,0	
Sound pressure	Cool / Heat (Hi)	dB(A)	52/52		55/55		56/56	
Sound power	Cool / Heat (Hi)	dB(A)	70/70		73/73		74/74	
Dimension	H x W x D	mm	996 x 980 x 370		996 x 980 x 370		996 x 980 x 370	
Net weight		kg	83		87		87	
Piping diameter	Liquid	Inch (mm)	3/8(9,52)		3/8(9,52)		3/8(9,52)	
	Gas	Inch (mm)	5/8(15,88)		5/8(15,88)		5/8(15,88)	
Pipe length range		m	5 - 50		5 - 50		5 - 50	
Elevation difference (in / out) ⁸⁾		m	15/30		15/30		15/30	
Pre-charged pipe length		m	30		30		30	
Additional gas amount		g/m	45		45		45	
Refrigerant (R32) / CO ₂ Eq.		kg / T	2,40/1,62		2,80/1,89		2,80/1,89	
Operating range	Cool Min ~ Max	°C	-10 ~ +43		-10 ~ +43		-10 ~ +43	
	Heat Min ~ Max	°C	-15 ~ +24		-15 ~ +24		-15 ~ +24	

1) EER and COP calculation is based in accordance to EN14511. 2) For models below 12 kW, the SEER and SCOP is calculated based on values of EU/626/2011. For models above 12 kW, the η_{s,c} / η_{s,h} values is calculated based on EN 14825. 3) Factory setting. 4) Medium external static pressure setting from factory. 5) The sound pressure of the units shows the value measured of the position 1,5 m below the unit. The sound pressure is measured in accordance with Eurovent 6/C/006-97 specification. 6) Connect the liquid socket tube (Ø6,35-Ø9,52) to the liquid tubing side indoor unit. 7) Connect the gas socket tube (Ø12,70-Ø15,88) to the gas tubing side indoor unit. 8) Outdoor unit located lower / outdoor unit located higher. * Recommended fuse for the indoor 3 A. ** Above values are in the case of standard installation(horizontal installation in the ceiling, rear side air intake) and nanoe™ X OFF.

Accessories	
CZ-RTC6W	CONEX wired remote controller (non-wireless), white
CZ-RTC6WBL	CONEX wired remote controller with Bluetooth®, white
CZ-RTC6WBLW	CONEX wired remote controller with Wi-Fi and Bluetooth®, white
CZ-RTC6	CONEX wired remote controller (non-wireless), black
CZ-RTC6BL	CONEX wired remote controller with Bluetooth®, black
CZ-RTC6BLW	CONEX wired remote controller with Wi-Fi and Bluetooth®, black
CZ-RTC5B	Wired remote controller with Econavi function and datanavi
CZ-RWS3 + CZ-RWRC3	Infrared remote controller and receiver
CZ-CAPWFC1	Commercial Wi-Fi Adaptor

Accessories	
PAW-PACR4	Interface to run up to 4 indoor unit groups on backup and alternative run
PAW-WTRAY	Tray for condenser water compatible with outdoor elevation platform
PAW-GRDBSE20	Outdoor base ground support for noise and vibration absorption
PAW-GRDSTD40	Outdoor elevation platform 400x900x400 mm
CZ-CENSC1	Econavi energy saving sensor
CZ-56DAF2	Air outlet plenum for S-3650PF3E
CZ-90DAF2	Air outlet plenum for S-6071PF3E
CZ-160DAF2	Air outlet plenum for S-1014PF3E

SEER: For S-1014PF3E + U-100PZ3E5. SCOP: For S-6071PF3E + U-60PZ3E5A. SUPER QUIET: For S-3650PF3E + U-36PZ3E5. INTERNET CONTROL: Optional.

Rating conditions: Cooling indoor 27 °C DB / 19 °C WB. Cooling outdoor 35 °C DB / 24 °C WB. Heating indoor 20 °C DB. Heating outdoor 7 °C DB / 6 °C WB. (DB: Dry Bulb; WB: Wet Bulb). Specifications subject to change without notice. For detailed information about ErP / Energy Labelling, please visit our websites www.aircon.panasonic.eu or www.ptc.panasonic.eu.

Panasonic Big PACi, not only environmentally friendly but also a groundbreaking product.

Big PACi with R32 has been introduced with full renewal of its indoor unit, also offering hydronic application by PACi Water heat exchanger.

1 Compact and light indoor body
Compact and light indoor body, keeping the high efficiency, has a split-able design for easy installation within a limited narrow space. Plus ease of maintenance due to the simplified disassembly design.

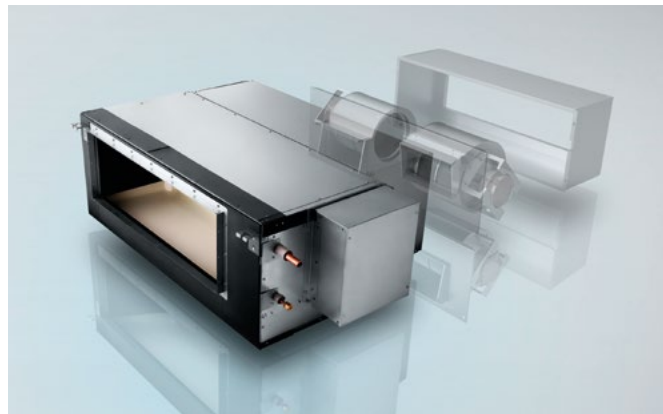

2 Easy pipe work with split-able hide-away indoor design
Heat exchanger and fan elements (fan + casing) can be separated during installation. The hide-away indoor unit is easily reassembled and will fit through a narrow space.

3 High external static pressure, maximum 200 Pa* setting
A high static pressure enables the use of long ducts for installation in a wide range of spaces.
* S-250PE3E5B.

4 Panasonic Comfort Cloud App control
Smartphone ready to control of PACi systems with Panasonic Comfort Cloud App*.
* Panasonic Wi-Fi Adaptor CZ-CAPWFC1 is required.

Compact and light indoor body, keeping high efficiency
15% lighter weight vs conventional model drastically improves installation work.

	Conventional model	Panasonic model
20,0 kW	100 kg	86 kg
25,0 kW	104 kg	88 kg



Maximum 200 Pa* static pressure setting
A high static pressure enables the use of long ducts for installation in a wide range of spaces.



3-step static pressure set up.
Selectable of static pressure modes can change 200 Pa / 130 Pa / 75 Pa for extra installation flexibility.
* In case of S-250PE3E5B.

Easy installation with light components
Indoor unit can easily be split into 3 components, the heaviest of which weighs only 48 kg.

Dimensions of each component (lightweight design for easy disassembly).

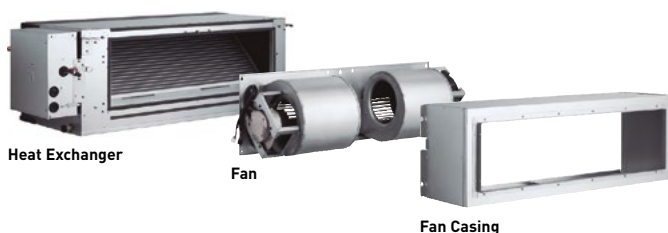

The weight is for S-200PE3E5B model.

Panasonic Big PACi high static pressure hide-away 20,0-25,0 kW · R32

+ COMPATIBLE WITH ALL PANASONIC CONNECTIVITY SOLUTIONS. FOR DETAILED INFORMATION GO TO THE CONTROL SYSTEMS SECTION

Optional:

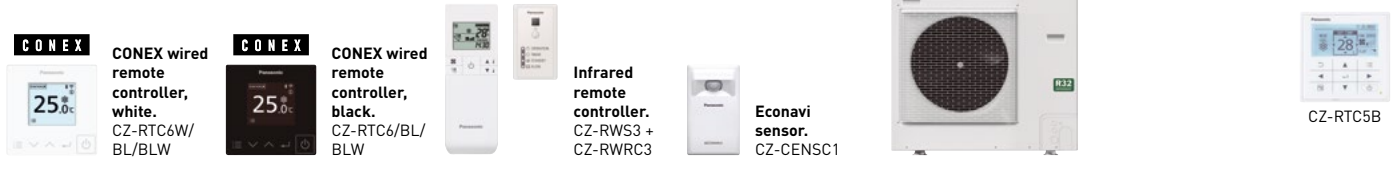

			Three phase	
			20,0 kW	25,0 kW
Kit			KIT-200PE3ZH8	KIT-250PE3ZH8
Remote controller			CZ-RTC5B	CZ-RTC5B
Cooling capacity	Nominal (Min - Max)	kW	19,5 [5,7 - 21,0]	23,2 [6,1 - 27,0]
EER ¹⁾	Nominal (Min - Max)	W/W	3,22 [3,09 - 4,52]	3,11 [2,93 - 4,59]
SEER / η _{sc} ²⁾			207,0%	190,6%
P _{design}		kW	19,5	23,2
Input power	Nominal (Min - Max)	kW	6,06 [1,26 - 6,80]	7,46 [1,33 - 9,20]
Heating capacity	Nominal (Min - Max)	kW	22,4 [5,0 - 25,0]	28,0 [5,5 - 29,0]
COP ¹⁾	Nominal (Min - Max)	W/W	3,61 [3,16 - 4,76]	3,41 [3,05 - 5,00]
SCOP / η _{s,h} ²⁾			141,3%	142,7%
P _{design} at -10 °C		kW	17,0	20,0
Input power	Nominal (Min - Max)	kW	6,21 [1,05 - 7,90]	8,21 [1,10 - 9,50]
Indoor unit			S-200PE3E5B	S-250PE3E5B
Power supply		V / ph / Hz	220 - 230 - 240 / 1/50	220 - 230 - 240 / 1/50
External static pressure at shipment (adjustable)		Pa	75 ³⁾ - 120 - 180	75 ³⁾ - 130 - 200
Air flow	Hi / Med / Lo	m ³ /min	72 / 63 / 53	84 / 72 / 59
Sound pressure ⁴⁾	Hi / Med / Lo	dB(A)	46 / 44 / 41	47 / 45 / 42
Dimension / Net weight	H x W x D	mm / kg	486 x 1456 x 916 / 86	486 x 1456 x 916 / 88
Outdoor unit			U-200PZH2E8	U-250PZH2E8
Power supply		V / ph / Hz	380 - 400 - 415 / 3/50	380 - 400 - 415 / 3/50
Recommended fuse		A	30	30
Air flow	Cool / Heat	m ³ /min	164 / 164	160 / 160
Sound pressure	Cool / Heat (Hi)	dB(A)	59 / 61	59 / 63
Sound power	Cool / Heat (Hi)	dB(A)	77 / 79	78 / 82
Dimension ⁵⁾ / Net weight	H x W x D	mm / kg	1500 x 980 x 370 / 117	1500 x 980 x 370 / 128
Piping diameter	Liquid / Gas	Inch (mm)	3/8 [9,52] / 1 [25,40]	1/2 [12,70] / 1 [25,40]
Pipe length range / Elevation difference (in / out)	m / m		5 - 90 / 30	5 - 60 / 30
Pre-charged pipe length / Additional gas amount	m / g/m		30 / 60	30 / 80
Refrigerant (R32) / CO ₂ Eq.		kg / T	4,20 / 2,835	5,20 / 3,51
Operating range	Cool Min ~ Max	°C	-15 ~ +46	-15 ~ +46
	Heat Min ~ Max	°C	-20 ~ +24	-20 ~ +24

1) EER and COP calculation is based in accordance to EN14511. 2) For models below 12 kW, the SEER and SCOP is calculated based on values of EU/626/2011. For models above 12 kW, the η_{sc} / η_{s,h} values is calculated based on EN 14825. 3) Factory setting. 4) The sound pressure of the units shows the value measured of the position 1,5 m below the unit. The sound pressure is measured in accordance with Eurovent 6/C/006-97 specification. 5) Add 100 mm for indoor unit or 70 mm for outdoor unit for piping port. * No filter included.

Accessories	
CZ-RTC6W	CONEX wired remote controller (non-wireless), white
CZ-RTC6WBL	CONEX wired remote controller with Bluetooth®, white
CZ-RTC6	CONEX wired remote controller (non-wireless), black
CZ-RTC6BL	CONEX wired remote controller with Bluetooth®, black
CZ-RTC5B	Wired remote controller with Econavi function and datanavi
CZ-RWS3 + CZ-RWRC3	Infrared remote controller and receiver

Accessories	
CZ-CAPDC3	Demand control for Mini ECOi and PACi outdoor units
CZ-CAPWFC1	Commercial Wi-Fi Adaptor
PAW-PACR4	Interface to run up to 4 indoor unit groups on backup and alternative run
PAW-GRDBSE20	Outdoor base ground support for noise and vibration absorption
PAW-GRDSTD40	Outdoor elevation platform 400 x 900 x 400 mm
CZ-CENSC1	Econavi energy saving sensor

Demand response compliant as a standard function

CZ-CAPDC3. This terminal allows demand control of the outdoor unit.

Several setting levels are available:

- Level-1, 2, 3: 75 / 50 / 0%
 - Level-1, 2 can be set in 40 - 100% (40, 45, 50...95, 100: each 5%)
- CZ-CAPDC3 also allows for forced stop which can be used for fire-alarm connection on LV3.

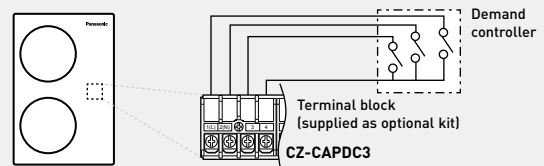

INTERNET CONTROL: Optional.

Rating conditions: Cooling indoor 27 °C DB / 19 °C WB. Cooling outdoor 35 °C DB / 24 °C WB. Heating indoor 20 °C DB. Heating outdoor 7 °C DB / 6 °C WB. (DB: Dry Bulb; WB: Wet Bulb). Specifications subject to change without notice. For detailed information about ErP / Energy Labelling, please visit our websites www.aircon.panasonic.eu or www.ptc.panasonic.eu.

Commercial twin, triple and double-twin systems · R32

With this system, a single outdoor unit can split its capacity simultaneously across up to 4 indoor units, for better distribution within the space. This makes the system particularly apt for common areas. It reduces noise concentration and enables the same temperature to be reached around the room. A wide variety of the same type of indoor units can be connected in multi combinations (including wall-mounted, cassette, hide-away and ceiling).



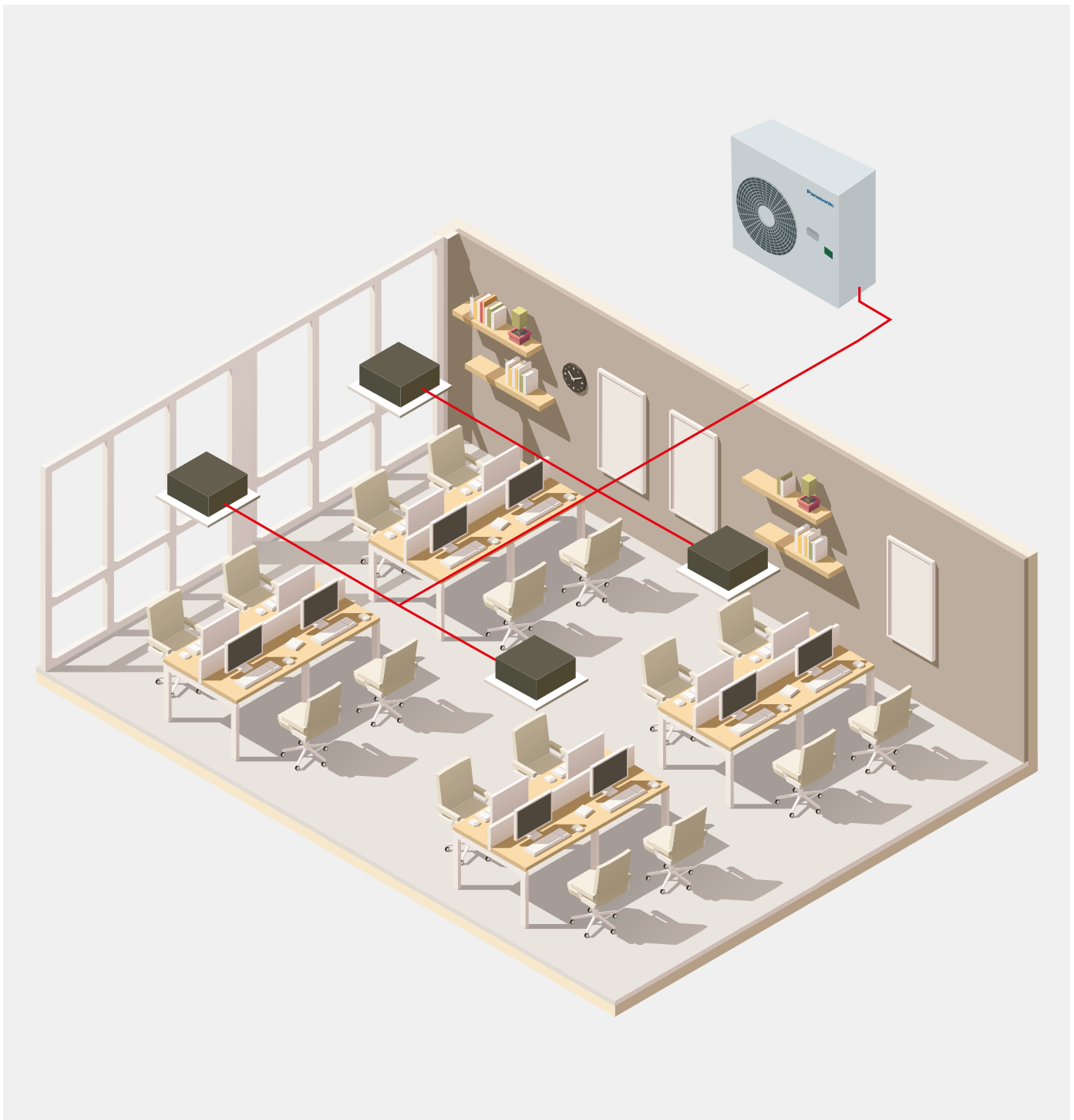

1 PACi NX Elite from 7,1 to 14,0 kW

Up to 4 indoor units can be connected to the same outdoor unit. Panasonic's Elite units 7,1, 10,0, 12,0 and 14,0 can be installed as twin, triple and double-twin systems. The indoor units can be combined as per the selection table. The operation will always be simultaneous. All the indoor units will work with the same settings.

2 PACi NX Standard from 10,0 to 14,0 kW

Up to 2 indoor units connectable on the same outdoor. Panasonic's Standard units can be installed as single and twin systems. The indoor units can be combined following the selection table. The operation will always be simultaneous. All the indoor units will work with the same settings.

3 Big PACi Elite from 20,0 to 25,0 kW

Up to 4 indoor units can be connected to the same outdoor unit. Panasonic's PACi units 20,0 and 25,0 can be installed as twin, triple and double-twin systems. The indoor units can be combined as per the selection table. The operation will always be simultaneous. All the indoor units will work with the same settings.

Commercial twin, triple and double-twin systems - R32

New
2023

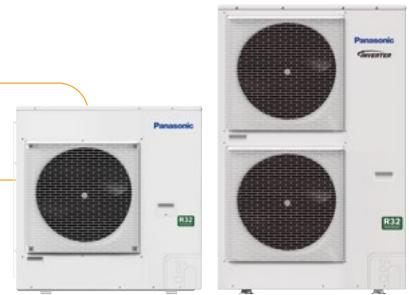

PACi Elite outdoor units - R32

			PACi NX				Big PACi	
			7,1 kW	10,0 kW	12,5 kW	14,0 kW	20,0 kW	25,0 kW
Outdoor unit single phase			U-71PZH4E5	U-100PZH4E5	U-125PZH4E5	U-140PZH4E5	—	—
Outdoor unit three phase			U-71PZH4E8	U-100PZH4E8	U-125PZH4E8	U-140PZH4E8	U-200PZH2E8	U-250PZH2E8
Cooling capacity ¹⁾	Nominal (Min - Max)	kW	7,1 (2,2 - 9,0)	9,5 (3,1 - 12,5)	12,5 (3,2 - 14,0)	13,4 (3,3 - 16,0)	20,0 (5,7 - 22,4)	25,0 (6,1 - 28,0)
Heating capacity ¹⁾	Nominal (Min - Max)	kW	8,0 (2,0 - 9,0)	11,2 (3,1 - 14,0)	14,0 (3,2 - 16,0)	16,0 (3,3 - 18,0)	22,4 (5,0 - 25,0)	28,0 (5,5 - 31,5)
Power supply	Single phase	V	220 - 230 - 240	220 - 230 - 240	220 - 230 - 240	220 - 230 - 240	—	—
	Three phase	V	380 - 400 - 415	380 - 400 - 415	380 - 400 - 415	380 - 400 - 415	380 - 400 - 415	380 - 400 - 415
Connection indoor / outdoor		mm ²	2x1,5 or 2,5	2x1,5 or 2,5	2x1,5 or 2,5	2x1,5 or 2,5	—	—
Air flow	Cool / Heat	m ³ /min	62,0/66,0	76,0/70,0	86,0/78,0	89,0/83,0	164/164	160/160
Sound pressure	Cool / Heat (Hi)	dB(A)	48/50	52/52	55/55	56/56	59/61	59/63
Sound power	Cool / Heat (Hi)	dB(A)	65/67	69/69	73/73	74/74	77/79	78/82
Dimension	HxWxD	mm	996x980x370	996x980x370	996x980x370	996x980x370	1500x980x370	1500x980x370
Net weight	1ph / 3ph	kg	66	84/82	86/84	86/84	117	128
	Liquid	Inch (mm)	3/8 (9,52)	3/8 (9,52)	3/8 (9,52)	3/8 (9,52)	3/8 (9,52)	1/2 (12,70)
Piping diameter	Gas	Inch (mm)	5/8 (15,88)	5/8 (15,88)	5/8 (15,88)	5/8 (15,88)	1 (25,40)	1 (25,40)
	Min ~ Max	m	5 ~ 60	5 ~ 100	5 ~ 100	5 ~ 100	5 ~ 80	5 ~ 60
Elevation difference (in / out)	Max	m	15/30 ²⁾	15/30 ²⁾	15/30 ²⁾	15/30 ²⁾	30	30
Pre-charged pipe length		m	30	30	30	30	30	30
Additional gas amount		g/m	30	40	40	40	60	80
Refrigerant (R32) / CO ₂ Eq.		kg / T	1,95/1,32	2,70/1,82	3,00/2,03	3,00/2,03	4,20/2,835	5,20/3,51
Operating range	Cool Min ~ Max	°C	-15 ~ +52	-20 ³⁾ ~ +52	-20 ³⁾ ~ +52	-20 ³⁾ ~ +52	-15 ~ +46	-15 ~ +46
	Heat Min ~ Max	°C	-20 ~ +24	-20 ~ +24	-20 ~ +24	-20 ~ +24	-20 ~ +24	-20 ~ +24

1) With 4 way 90x90 cassette. 2) Outdoor unit located lower / outdoor unit located higher. 3) Pipe length up to 30 m.



PACi NX Standard outdoor units - R32

			10,0 kW	12,5 kW	14,0 kW
Outdoor unit single phase			U-100PZ3E5	U-125PZ3E5	U-140PZ3E5
Outdoor unit three phase			U-100PZ3E8	U-125PZ3E8	U-140PZ3E8
Cooling capacity ¹⁾	Nominal (Min - Max)	kW	10,0 (3,0 - 11,5)	12,5 (3,2 - 13,5)	14,0 (3,3 - 15,0)
Heating capacity ¹⁾	Nominal (Min - Max)	kW	10,0 (3,0 - 14,0)	12,5 (3,3 - 15,0)	14,0 (3,4 - 16,0)
Power supply	Single phase	V	220-230-240	220-230-240	220-230-240
	Three phase	V	380 - 400 - 415	380 - 400 - 415	380 - 400 - 415
Connection indoor / outdoor		mm ²	2x1,5 or 2,5	2x1,5 or 2,5	2x1,5 or 2,5
Air flow	Cool / Heat	m ³ /min	73,0/73,0	82,0/80,0	84,0/82,0
Sound pressure	Cool / Heat (Hi)	dB(A)	52/52	55/55	56/56
Sound power	Cool / Heat (Hi)	dB(A)	70/70	73/73	74/74
Dimension	HxWxD	mm	996x980x370	996x980x370	996x980x370
Net weight		kg	83	87	87
	Liquid	Inch (mm)	3/8 (9,52)	3/8 (9,52)	3/8 (9,52)
Piping diameter	Gas	Inch (mm)	5/8 (15,88)	5/8 (15,88)	5/8 (15,88)
	Min ~ Max	m	5 ~ 50	5 ~ 50	5 ~ 50
Elevation difference (in / out) ²⁾	Max	m	15/30	15/30	15/30
Pre-charged pipe length		m	30	30	30
Additional gas amount		g/m	45	45	45
Refrigerant (R32) / CO ₂ Eq.		kg / T	2,4/1,62	2,8/1,89	2,8/1,89
Operating range	Cool Min ~ Max	°C	-10 ~ +43	-10 ~ +43	-10 ~ +43
	Heat Min ~ Max	°C	-15 ~ 24	-15 ~ 24	-15 ~ 24

1) With 4 way 90x90 cassette. 2) Outdoor unit located lower / outdoor unit located higher.

Compatible indoor units for multi combinations

Optional:

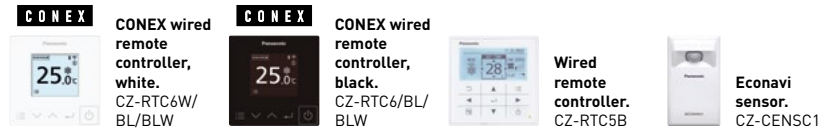

PANASONIC AC SMART CLOUD and AC SERVICE CLOUD: Optional.



Wall-mounted	Indoor unit	Cooling capacity	Heating capacity	Dimension	Sound pressure ¹⁾	Air flow ²⁾
		kW	kW	HxWxD mm	Hi / Med / Lo dB(A)	Hi / Med / Lo m ³ /min
3,6 - 5,0 kW	S-3650PK3E	3,6-5,0	4,0-5,6	302x1120x236	35/31/27 - 40/36/32	13,0/11,0/9,0 - 16,0/13,5/11,0
6,0 - 7,1 kW	S-6010PK3E	6,1-7,1	7,0-8,0	302x1120x236	47/44/40 - 47/44/40	20,0/17,5/14,5 - 20,0/17,5/14,5
10,0 kW	S-6010PK3E	9,5	9,5	302x1120x236	49/45/41	22,0/18,5/15,0



PANASONIC AC SMART CLOUD and AC SERVICE CLOUD: Optional.



4 way 60x60 cassette	Indoor unit (panel CZ-KPY4)	Cooling capacity	Heating capacity	Dimension indoor / panel	Sound pressure ¹⁾	Air flow ²⁾
		kW	kW	HxWxD mm	Hi / Med / Lo dB(A)	Hi / Med / Lo m ³ /min
2,5 kW	S-25PY3E	2,5	3,2	243x575x575 / 30x625x625	31/28/25	8,5/7,0/6,0
3,6 kW	S-36PY3E	3,6	4,0	243x575x575 / 30x625x625	34/30/25	9,5/7,5/6,0
5,0 kW	S-50PY3E	5,0	5,6	243x575x575 / 30x625x625	39/34/27	12,0/9,5/6,5
6,0 kW	S-60PY3E	6,0	7,0	243x575x575 / 30x625x625	43/37/31	14,0/10,5/8,0



PANASONIC AC SMART CLOUD and AC SERVICE CLOUD: Optional.



4 way 90x90 cassette	Indoor unit (panels CZ-KPU3W/3AW)	Cooling capacity	Heating capacity	Dimension indoor / panel	Sound pressure ¹⁾	Air flow ²⁾
		kW	kW	HxWxD mm	Hi / Med / Lo dB(A)	Hi / Med / Lo m ³ /min
3,6 - 5,0 kW	S-3650PU3E	3,6-5,0	4,0-5,6	256x840x840 / 33,5x950x950	30/28/27 - 32/29/27	14,5/13,0/11,5 - 16,5/13,5/11,5
6,0 - 7,1 kW	S-6071PU3E	6,0-7,1	7,0-8,0	256x840x840 / 33,5x950x950	36/31/28 - 37/31/28	21,0/16,0/13,0 - 22,0/16,0/13,0
10,0 - 12,5 kW	S-1014PU3E	10,0-12,5	11,2-14,0	319x840x840 / 33,5x950x950	45/38/32 - 46/39/33	36,0/26,0/18,0 - 37,0/27,0/19,0
14,0 kW	S-1014PU3E	14,0	16,0	319x840x840 / 33,5x950x950	47/40/34	38,0/29,0/20,0



PANASONIC AC SMART CLOUD and AC SERVICE CLOUD: Optional.



Ceiling	Indoor unit	Cooling capacity	Heating capacity	Dimension	Sound pressure ¹⁾	Air flow ²⁾
		kW	kW	HxWxD mm	Hi / Med / Lo dB(A)	Hi / Med / Lo m ³ /min
3,6 - 5,0 kW	S-3650PT3E	3,5-5,0	4,0-5,6	235x960x690	36/32/28 - 37/33/28	14,0/12,0/10,5 - 15,0/12,5/10,5
6,0 - 7,1 kW	S-6071PT3E	6,0-6,8	7,0-8,0	235x1275x690	38/34/29 - 39/35/30	20,0/17,0/14,5 - 21,0/18,0/15,5
10,0 - 12,5 kW	S-1014PT3E	9,5-12,1	11,2-14,0	235x1590x690	42/37/34 - 46/40/35	30,0/25,0/23,0 - 34,0/28,0/24,0
14,0 kW	S-1014PT3E	13,4	16,0	235x1590x690	47/41/36	35,0/29,0/25,0



PANASONIC AC SMART CLOUD and AC SERVICE CLOUD: Optional.



Adaptive ducted unit	Indoor unit	Cooling capacity	Heating capacity	Dimension	External static pressure	Sound pressure ¹⁾	Air flow ²⁾
		kW	kW	HxWxD mm	Nominal (Min - Max) Pa	Hi / Med / Lo dB(A)	Hi / Med / Lo m ³ /min
3,6 - 5,0 kW	S-3650PF3E	3,6-5,0	4,0-5,6	250x800x730	30(10-150) - 30(10-150)	30/27/22 - 34/30/25	14,0/13,0/10,0 - 16,0/15,0/12,0
6,0 - 7,1 kW	S-6071PF3E	5,7-6,8	7,0-7,5	250x1000x730	30(10-150) - 30(10-150)	30/26/23 - 30/26/23	21,0/19,0/15,0 - 21,0/19,0/15,0
10,0 - 12,5 kW	S-1014PF3E	9,5-12,1	10,8-13,5	250x1400x730	40(10-150) - 50(10-150)	33/29/25 - 35/31/27	32,0/26,0/21,0 - 34,0/29,0/23,0
14,0 kW	S-1014PF3E	13,4	15,5	250x1400x730	50(10-150)	39/35/29	36,0/32,0/25,0

* The data shown in these tables are based on PACi NX Elite combinations. 1) The sound pressure is measured in accordance with Eurovent 6/C/006-97 specification. 2) Factory setting.

Rating conditions: Cooling indoor 27 °C DB / 19 °C WB. Cooling outdoor 35 °C DB / 24 °C WB. Heating indoor 20 °C DB. Heating outdoor 7 °C DB / 6 °C WB. (DB: Dry Bulb, WB: Wet Bulb). Specifications subject to change without notice. For detailed information about ErP / Energy Labelling, please visit our websites www.aircon.panasonic.eu or www.ptc.panasonic.eu.

Simultaneous operation system combinations

PACi NX Elite from 7,1 to 14,0 kW simultaneous operation system combinations - R32

Capacity	Indoor	Outdoor			
		7,1 kW	10,0 kW	12,5 kW	14,0 kW
2,5 kW	S-25PY3E	Triple U-71 (3x 2,5)	Double-twin U-100 (2x 2,5)		
3,6 kW	S-36PY3E S-3650PF3E S-3650PK3E S-3650PT3E S-3650PU3E	Twin U-71 (2x 3,6)	Triple U-100 (3x 3,6)	Double-twin U-125 (2x 3,6)	
4,5 kW	S-3650PF3E S-3650PK3E S-3650PT3E S-3650PU3E			Triple U-125 (3x 4,5)	
5,0 kW	S-50PY3E S-3650PF3E S-3650PK3E S-3650PT3E S-3650PU3E		Twin U-100 (2x 5,0)		Triple U-140 (3x 5,0)
6,0 kW	S-60PY3E S-6071PF3E S-6010PK3E S-6071PT3E S-6071PU3E			Twin U-125 (2x 6,0)	
7,1 kW	S-6071PF3E S-6010PK3E S-6071PT3E S-6071PU3E				Twin U-140 (2x 7,1)

PACi NX Standard from 10,0 to 14,0 kW simultaneous operation system combinations - R32

Capacity	Indoor	Outdoor		
		10,0 kW	12,5 kW	14,0 kW
5,0 kW	S-50PY3E S-3650PF3E S-3650PK3E S-3650PT3E S-3650PU3E	Twin U-100 (2x 5,0)		
6,0 kW	S-60PY3E S-6071PF3E S-6010PK3E S-6071PT3E S-6071PU3E		Twin U-125 (2x 6,0)	
7,1 kW	S-6071PF3E S-6010PK3E S-6071PT3E S-6071PU3E			Twin U-140 (2x 7,1)

Big PACi Elite from 20,0 to 25,0 kW simultaneous operation system combinations - R32

Capacity	Indoor	Outdoor	
		20,0 kW	25,0 kW
5,0 kW	S-50PY3E S-3650PF3E S-3650PK3E S-3650PT3E S-3650PU3E	Double-twin U-200 (2x 5,0)	
6,0 kW	S-60PY3E S-6071PF3E S-6010PK3E S-6071PT3E S-6071PU3E		Double-twin U-250 (2x 6,0)
7,1 kW	S-6071PF3E S-6010PK3E S-6071PT3E S-6071PU3E	Triple U-200 (3x 7,1)	
10,0 kW	S-1014PF3E S-6010PK3E S-1014PT3E S-1014PU3E	Twin U-200 (2x 10,0)	
12,5 kW	S-1014PF3E S-1014PT3E S-1014PU3E		Twin U-250 (2x 12,5)

Refrigerant piping arrangements

Single

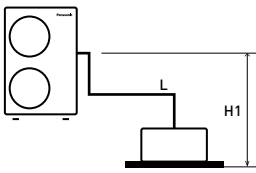

Twin

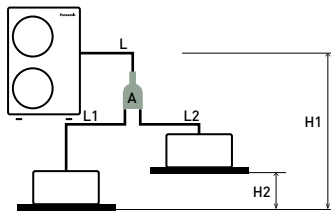

Triple

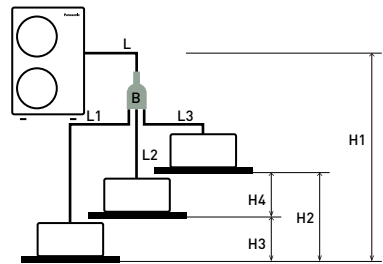

Double-twin

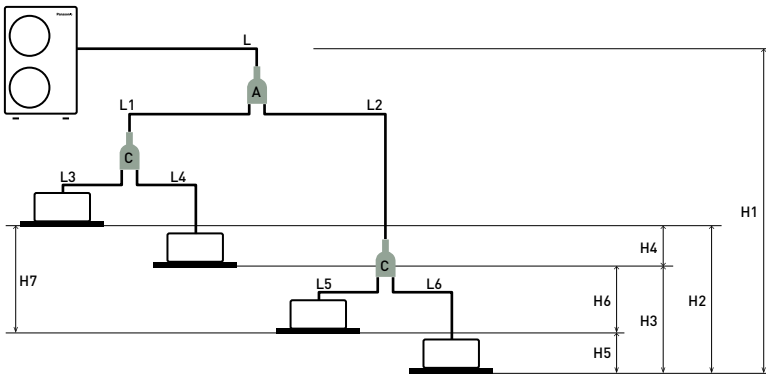

PACi NX Elite twin, triple and double-twin system from 7,1 to 14,0 kW

Joint distribution (sold separately)
 A= CZ-P224BK2BM
 B= CZ-P3 HPC2BM
 C= CZ-P224BK2BM

PACi NX Standard twin system from 10,0 to 14,0 kW

Joint distribution (sold separately)
 A= CZ-P224BK2BM

PACi Elite twin, triple and double-twin system from 20,0 to 25,0 kW

Joint distribution (sold separately)
 A= CZ-P680BK2BM
 B= CZ-P3 HPC2BM
 C= CZ-P224BK2BM

Twin System	PACi NX Standard single and twin system from 7,1 to 14,0 kW				PACi NX Elite and PACi Elite twin, triple and double-twin system from 7,1 to 25 kW							
	Indoor unit combinations (see examples above)		Equivalent lengths and height differences (m) for outdoor unit sizes...		Indoor unit combinations (see examples above)				Equivalent lengths and height differences (m) for outdoor unit sizes from 7,1 to 14,0 kW		Equivalent lengths and height differences (m) for outdoor unit sizes from 20,0 to 25,0 kW	
	Single	Twin	Single	Twin	Single	Twin	Triple	Double-Twin				
Total pipe length	L	L + L1 + L2	≤ 50 m	L	L + L1 + L2	L + L1 + L2 + L3	L + L1 + L2 + L3 + L4 + L5 + L6	U-60/U-71: ≤ 50 m U-100/125/140: ≤ 75 m			U-200: ≤ 100 m U-250: ≤ 80 m	
Maximum pipe length from outdoor unit to most distant indoor unit	-	-	-	-	L + L1 or L + L2	L + L1 or L + L2 or L + L3	L + L1 + L3 or L + L1 + L4 or L + L2 + L5 or L + L2 + L6	-			U-200: 90 m U-250: 60 m	
Maximum branch pipe length	-	L1 L2	≤ 15	-	L1 or L2	L1 or L2 or L3	L1 + L3 or L1 + L4 or L2 + L5 or L2 + L6	≤ 15 m			≤ 20 m	
Maximum branch pipe length differences	-	L1 > L2 L1 - L2	≤ 10	-	L1 > L2; L1 - L2	L1 > L2 > L3: L1 - L2 L2 - L3 L1 - L3	L2 + L6 (Max.) L1 + L3 (Min.): (L2 + L6) - (L1 + L3)	≤ 10 m			≤ 10 m	
Maximum pipe length differences after first branch (Double-Twin)	-	-	-	-	-	-	L2 > L1: L2 - L1	≤ 10 m			≤ 10 m	
Maximum pipe length differences after second branch (Double-Twin)	-	-	-	-	-	-	L4 > L3: L4 - L3 L6 > L5: L6 - L5	≤ 10 m			≤ 10 m	
Height difference (outdoor unit located higher)	H1	H1	≤ 30	H1	H1	H1	H1	≤ 30 m			≤ 30 m	
Height difference (outdoor unit located lower)	H1	H1	≤ 15	H1	H1	H1	H1	≤ 15 m			≤ 15 m	
Height difference between indoor units	-	H2	≤ 0,5	-	H2	H2 or H3 or H4	H2 or H3 or H4 or H5 or H6	≤ 0,5 m			≤ 0,5 m	

Twin System	PACi NX Standard single and twin system from 7,1 to 14,0 kW				PACi NX Elite twin, triple and double-twin system from 7,1 to 14,0 kW						PACi Elite twin, triple and double-twin system from 20,0 to 25,0 kW				
	Outdoor unit main piping diameter (L)		Indoor unit connection tube (L1, L2)		Outdoor unit main piping diameter (L)	Indoor unit connection piping diameter (L1, L2, L3, L4) (mm)					Outdoor unit main piping diameter (L) (mm)	Double-Twin distribution pipe (L1, L2) ¹⁾		Indoor unit connection piping diameter ²⁾	
Unit type capacity	100	125	50	60	71 - 140	36	45	50	60	71	200	250	100 - 125	50	60 - 125
Liquid (mm)	Ø 9,52	Ø 12,70	Ø 6,35	Ø 9,52	Ø 9,52	Ø 6,35	Ø 6,35	Ø 6,35	Ø 9,52	Ø 9,52	Ø 9,52	Ø 12,70	Ø 9,52	Ø 6,35	Ø 9,52
Gas (mm)	Ø 15,88	Ø 15,88	Ø 12,70	Ø 15,88	Ø 15,88	Ø 12,70	Ø 12,70	Ø 12,70	Ø 15,88	Ø 15,88	Ø 25,40	Ø 25,40	Ø 15,88	Ø 12,70	Ø 15,88
Additional gas amount (g/m)	50	50	20	50	50	20	20	20	50	50	60	80	45	20	45

1) Total capacity of indoor unit connected after the branch. 2) 4 way cassette type.

Make additional charges by adding up tube length in an order of main tube (L) > branch tube (L1 > L2 > L3 wide diameter) and then selecting the amount of refrigerant corresponding to the remaining (after charge-less tube length: 30 m) liquid tube diameter and tube length from the above table.

PRO-HT Tank Series for PACi

Enjoy an efficient DHW / heating and cooling tank.

Panasonic commercial PRO-HT Tank solutions meet all needs of your hot water applications providing 65 °C water.

Maximum 65 °C
water outlet temperature



PRO-HT Tank DHW: PAW-VP750DHW and PAW-VP1000LDHW

PRO-HT TANK

Big volume and high temperature tank for commercial application.

1 High performance and high saving

- Energy efficiency class for energy label: A+ (from A+ to F)
- High temperature hot water without booster
- Save installation time and cost by skipping additional accessories

2 Sufficient hot water production

- Maximum water outlet temperature up to 65 °C
- Big volume tanks with 750 L and 1000 L capacity
- Heat exchanger design inhibits limescale

3 Trusted quality

- Double tube heat exchanger following drinking-water regulation
- Tank and heat exchanger made with stainless steel
- Internal and external pickling

Solution example DHW tank 1000 L + PACi

- Ideal for small hotels and high-end residential
- Hot water temperature up to 65 °C

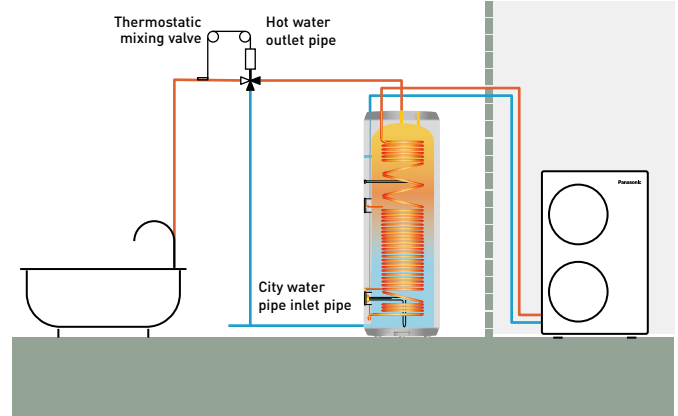

One by one system compatible list with PACi Elite

Model	Tank type	Product compatibility	Hot water outlet temperature without an electric heater
PAW-VP750LDHW-1	DHW	U-250PE2E8A	65 °C
PAW-VP1000LDHW-1	DHW	U-250PE2E8A	65 °C

PRO-HT Tank heating and cooling: PAW-VP380L

Waterborne heating and cooling for floor heating, radiators or fan coils

1 High performance and high saving

- A7 COP 3,26, heating water temperature at 50 °C
- Maximum 50 °C water outlet temperature
- Energy efficiency class: A+++ (from A+++ to D)

2 Simple waterborne heating and cooling solution

- High temperature water without any boosters
- Installation cost can be saved without additional boosters and buffer tanks

3 Trusted quality

- Tank and heat exchanger made with stainless steel
- Internal and external pickling

Heating and cooling tank 380L + PACi 20,0 kW

- Ideal offer for small offices
- Cost saving solution with simple waterborne heating and cooling
- Hot water up to 50 °C

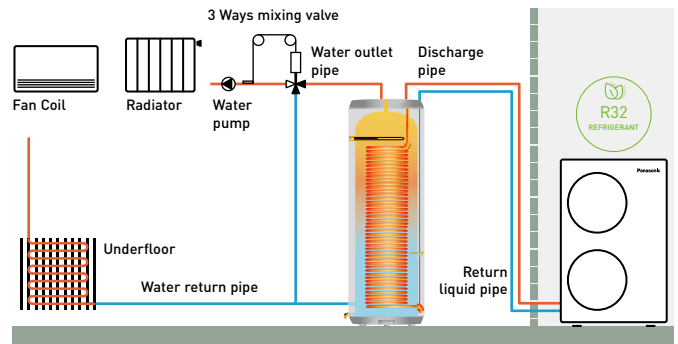

One by one system compatible list with PACi Elite

Model	Tank type	Product compatibility	Water outlet temperature range
PAW-VP380L	Heating and cooling	U-200PZH2E8	5 °C ~ 50 °C

PRO-HT Tank DHW

PRO-HT TANK



High temperature hot water is efficiently produced without any boosters.
Panasonic commercial PRO-HT Tank solutions can be adapted to various projects from high-end residential to gyms, and hotels.

PRO-HT Tank			PAW-VP750LDHW-1	PAW-VP1000LDHW-1
COP DHW (A +7 °C, W 10-55 °C) EN 16147 ¹⁾			4,10	3,86
COP DHW (A +15 °C, W 10-55 °C) EN 16147 ²⁾			4,79	4,79
Energy efficiency class (from A+ to F) ³⁾			A+	A+
Water volume (net)	L		726	933
Reference tapping cycle			2XL	2XL
Standby heat loss according to EN16147	W/h		77	80
Maximum water temperature	Heat pump	°C	65	65
	Electrical heater	°C	85	85
Dimension	H x Ø	mm	1855 x 990	2210 x 990
Net weight / with water	kg		179 / 905	191 / 1124
Stainless steel 316 L tank			Yes	Yes
Connections to the water supply network			RP 1½	RP 1½
Average insulation thickness	mm		100	100
Number of electrical heaters x power	W		1 x 6000	1 x 6000
Electric protection	A		16	16
Moisture protection (PAW-VP-RTC5B-PAC)			IP24	IP24
Heat exchanger connection	Inlet	Inch (mm)	1/2 (12,70)	1/2 (12,70)
	Outlet	Inch (mm)	3/4 (19,05)	3/4 (19,05)
Outdoor unit			U-250PE2E8A	U-250PE2E8A
Nominal electrical power - related to rated heat output	W		6670	6670
Energy consumption by chosen cycle (A +7 °C, W 10-55 °C)	kWh		6,00	6,36
Energy consumption by chosen cycle (A +15 °C, W 10-55 °C)	kWh		5,12	5,12
Power supply	Voltage	V	400	400
	Phase		Three phase	Three phase
	Frequency	Hz	50	50
Maximum power consumption	Without heater	W	12900	12900
	With heater	W	18900	18900
Dimension	H x W x D	mm	1642 x 1095 x 529	1642 x 1095 x 529
Net weight	kg		138	138
Sound pressure at 1 m from outdoor unit	dB(A)		57	57
Refrigerant (R410A) / CO ₂ Eq.	kg / T		6,4 / 13,363	6,4 / 13,363
Piping diameter	Liquid	Inch (mm)	1/2 (12,70)	1/2 (12,70)
	Gas	Inch (mm)	1 (25,40)	1 (25,40)
Pipe length range ⁴⁾	m		30	30
Elevation difference (in / out)	m		30 (OU above) 30 (OU below)	30 (OU above) 30 (OU below)
Pipe length for nominal capacity	m		7,5	7,5
Pre-charged pipe length	m		> 7,5	> 7,5
Additional gas amount	g/m		Refer to manual	Refer to manual
Operating range - outdoor ambient	Heat Min ~ Max	°C	-20 ~ +35	-20 ~ +35

1) Heating of sanitary water up to 55 °C with inlet air temperature at 7 °C, humidity at 89% and inlet water temperature at 10 °C. According to EN16147. 2) Heating of sanitary water up to 55 °C with inlet air temperature at 15 °C, humidity at 74% and inlet water temperature at 10 °C. According to EN16147. 3) Scale from A+ to F following COMMISSION DELEGATED REGULATION (EU) No. 812/2013. 4) The pipe length range is between indoor and outdoor, but does not include additional length for coil.

This product is designed to comply with the European Water Quality Directive 98/83/EC amended by 2015/1787/EU. The lifespan of the product is not guaranteed in the case of the use of groundwater, such as spring water or well water, the use of tap water when salt or other impurities are contained, nor in areas of acidic water quality. Maintenance and warranty costs related to these cases are the customer's responsibility.

* When connected as pressurised, safety valve is mandatory.

Accessories

PAW-VP-RTC5B-PAC Tank controller for PACi system

Technical focus

- Water volume 750 L and 1000 L
- Maximum hot water production 65 °C without boosters
- Heating coil 52 m (750 L) and 63 m (1000 L)
- Tank material 3 mm
- ABS external case



PRO-HT Tank heating and cooling

High temperature hot water is efficiently produced without any boosters.
Panasonic commercial PRO-HT Tank solutions can be combined with PACi to adapt various projects from high-end residential to small offices.

PRO-HT TANK



PRO-HT Tank		PAW-VP380L	
Cooling capacity at 35 °C, water outlet 7 °C		kW	12,8
Heating capacity		kW	25
Heating capacity at +7 °C, heating water temperature at 45 °C		kW	23
COP at +7 °C with heating water temperature at 45 °C		W/W	3,26
Heating energy efficiency class at 35 °C (from A+++ to D)			A+++
$\eta_{s,h}$ (LOT1) ¹⁾		%	193
Dimension	H x Ø	mm	1820 x 690
Water volume (net)		L	380
Shipping weight		kg	99
Connections to the water supply network			RP 1¼
Heating water flow (ΔT=5 K, 35 °C)		m³/h	3,9
Water outlet	Cool Min ~ Max	°C	5 ~ 15
	Heat Min ~ Max	°C	25 ~ 45
Piping diameter	Liquid	Inch (mm)	1/2 (12,70)
	Gas	Inch (mm)	3/4 (19,05)
Outdoor unit			U-200PZH2E8
Dimension	HxWxD	mm	1500x980x370
Net weight		kg	117
Sound pressure at 1 m from outdoor unit		dB(A)	57
Refrigerant (R32) / CO ₂ Eq.		kg	4,20 / 3 510
Piping diameter	Liquid	Inch (mm)	3/8 (9,52)
	Gas	Inch (mm)	1 (25,40) + adapter
Pipe length range ²⁾		m	30
Elevation difference (in / out)		m	30 (OU above) 30 (OU below)
Pipe length for nominal capacity		m	7,5
Pre-charged pipe length		m	> 7,5
Additional gas amount		g/m	Refer to manual
Operating range - outdoor ambient	Cool Min ~ Max	°C	-15 ~ +46
	Heat Min ~ Max	°C	-20 ~ +35

1) Seasonal space cooling / heating energy efficiency following COMMISSION REGULATION (EU) 811/2013. 2) The pipe length range is between indoor and outdoor, but does not include additional length for coil.

This product is designed to comply with the European Water Quality Directive 98/83/EC amended by 2015/1787/EU. The lifespan of the product is not guaranteed in the case of the use of groundwater, such as spring water or well water, the use of tap water when salt or other impurities are contained, nor in areas of acidic water quality. Maintenance and warranty costs related to these cases are the customer's responsibility.

Performance calculation in agreement with Eurovent. Sound pressure measured at 1 m from the outdoor unit and at 1,5 m height.

* Flow switch and water filter are not equipped.

Accessories

PAW-VP-RTC5B-PAC	Tank controller for PACi system
PAW-IU39	Additional heater

Technical focus

- Water volume 380 L
- Maximum hot water production 50 °C
- Tank and heat exchanger made with stainless steel
- Heating coil 52 m 316 L
- Internal and external pickling
- Foam insulation 70 mm
- Tank material 2 mm 316 L
- ABS external case



Panasonic PACi with Water Heat Exchanger for chilled and hot water production

Introducing a highly-efficient Water Heat Exchanger for PACi Series. This ground-breaking product provides further possibilities by adding hydronic options.

Water outlet temperature:
Cooling: 5 ~ 15 °C
Heating: 30 ~ 55 °C



Highly-efficient Water Heat Exchanger for PACi Series.

System example.

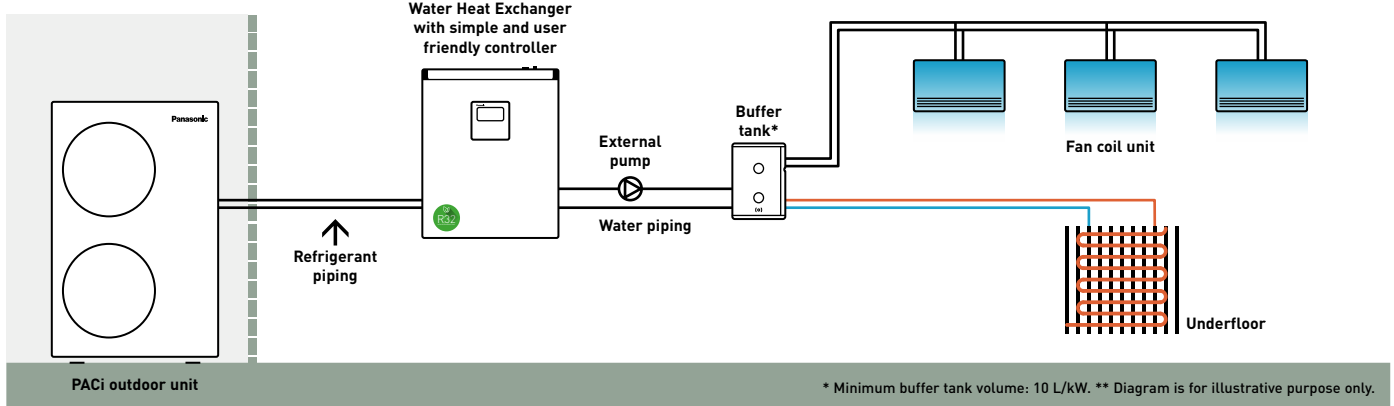

1 Cost saving solution

- A+++ Energy efficiency class (scale from A+++ to D)
- Cost effective water projects thanks to lower cost for PACi compared to VRF
- Reducing the amount of HFC refrigeration in the project

2 Flexible and space saving system

- 2 installation possibilities (wall-mounted / floor-standing)
- Compact, lightweight unit design, only 27 kg

3 Easy installation, maintenance

- Quick mounting process
- Flow switch kit is included as a standard
- Direct access to electrical box
- Operation down to -20 °C ambient without the need for glycol

Flexible and space saving system

Compact and light unit.

- Only 205 mm depth fits within a limited space
- Lightweight design at only 27 kg, makes it easy to maneuver and position
- Maximum total refrigerant piping length: 90 m*

* 90 m for PAW-200W5APAC-1.

2 installation options.

- Wall-mounted and floor-standing installation options are available. Free-up floor space by using the wall-mounted installation
- Quick mounting process with its lightweight compact design
Make fixing holes > Fix 2 screws > Hang the unit > Finish

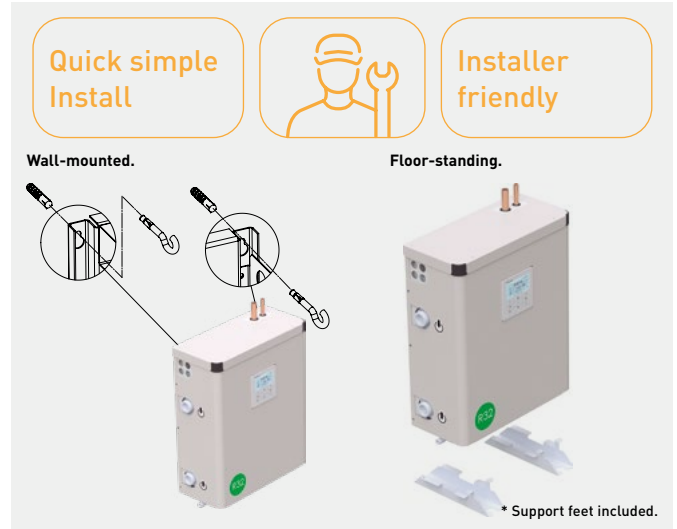
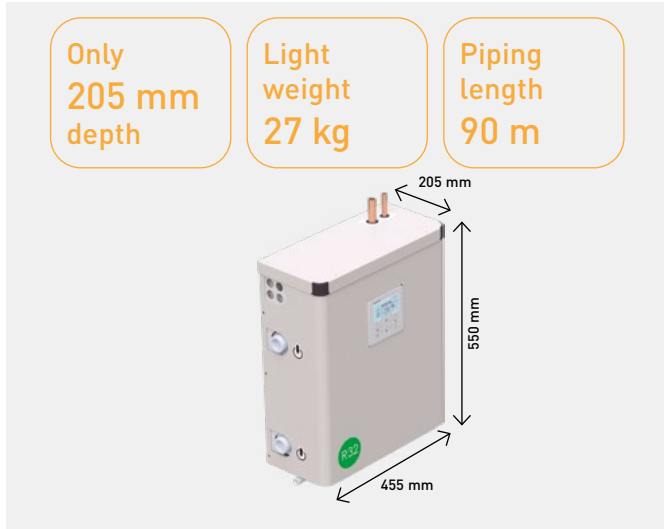

Foodchain/Small office application

- Fulfilling R32 refrigerant needs to follow environmental perspective, Company policy
- Hydraulic system to reduce total amount of HFC refrigeration
- Water solution to substitute electric heating system



Foodchain.

Residential/Commercial retail application

- Water solution to substitute existing boiler system
- For heating projects with longer than 50 m piping



Commercial retail.

PACi Water Heat Exchanger (WHE) is the ideal solution for residential and commercial applications; the investment costs can be amortised in a short period.

Easy maintenance operation from two points of access

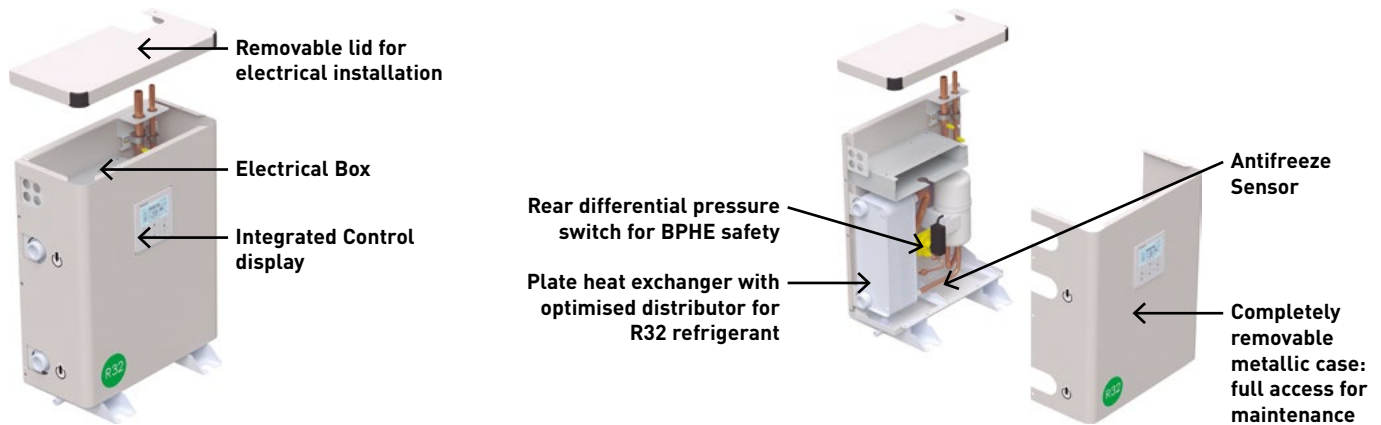

Integrated cascade control as standard for maximum ease and flexibility

Built-in cascade control for 2 units.

The control of 2 refrigerant systems can be combined together in a cascade. This option is included in the standard scope of delivery on the WHE. It is activated using the one of the CZ-RTC5B remote controllers on the units as master. Rotation and Backup operation modes can be selected.

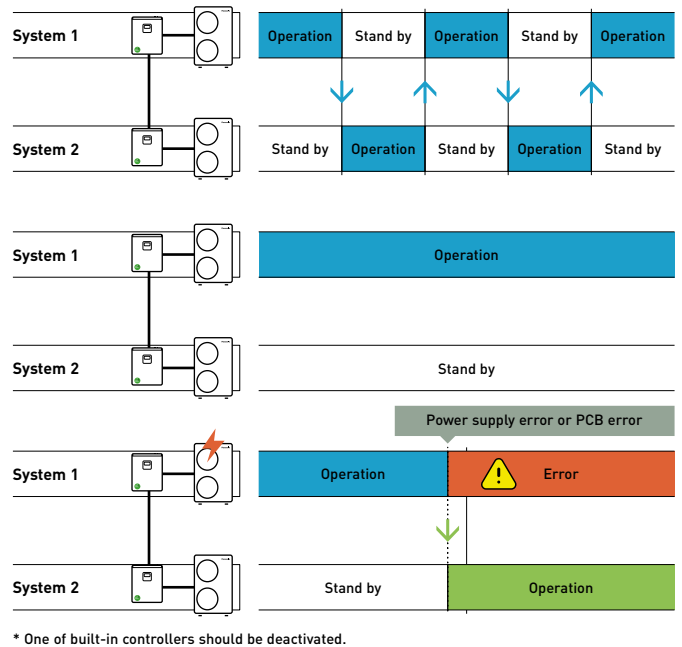
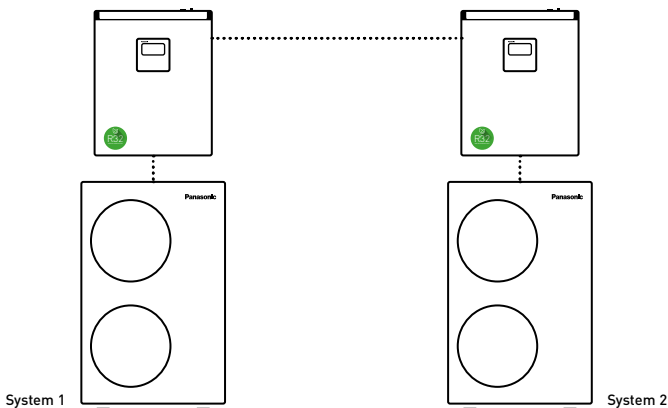

PACi Water Heat Exchanger can be connected as a cascade with up to 4 groups of 8 units, reaching up to 600 kW

Optional PAW-PACR4 cascade controller allows up to three groups, with each group containing between 1-8 units, to be combined into a cascade for failure substitution or temperature assist.

- Maximum 4 groups (up to 8 units per group)
- Rotation
- Failure substitution
- Temperature assist
- Operation output signal
- Alarm output signal

Example: 4 x groups.
 Maximum available capacity per group: 8 x 25 kW = 200 kW.
 Total maximum available capacity: 4 x 200 kW = 600 kW.

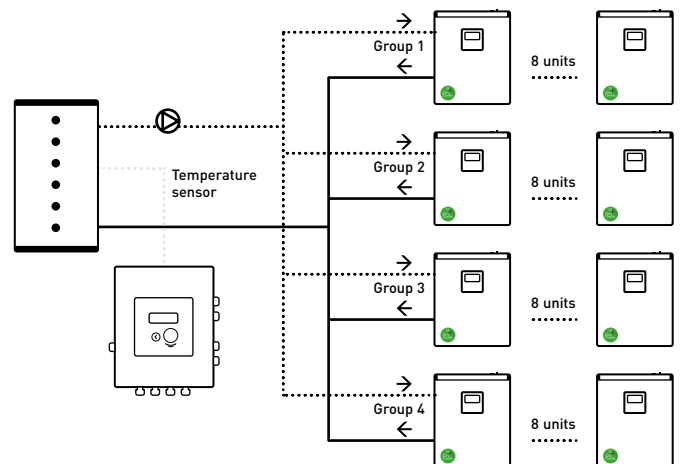

PACi with Water Heat Exchanger for chilled and hot water production

Constant 55 °C flow available.

Short-term investment recovery.

PACi Water Heat Exchanger is ideal for small offices and retails. The investment costs can be amortised within a very short period. This solution allows investors and operators to save money.



Water Heat Exchanger			PAW-200W5APAC-1	PAW-250W5APAC-1
Cooling capacity ¹⁾		kW	20,0	26,0
EER ¹⁾		W/W	3,03	2,89
Heating capacity ²⁾		kW	26,5	31,6
COP ²⁾		W/W	3,34	3,31
Energy efficiency class (Scale A+++ to D) ³⁾	35 °C (low temperature HP)		A+++	A+++
	55 °C (low temperature HP)		A+	A+
$\eta_{s,h}$ (LOT1) ⁴⁾		%	178	178
Dimension	H x W x D	mm	550 x 455 x 205	550 x 455 x 205
Net weight		kg	27	27
Water pipe connector		Inch	Male Thread 1 1/4	Male Thread 1 1/4
Cooling water flow ($\Delta T=5$ K, 35 °C)		m ³ /h	3,45	4,30
Heating water flow ($\Delta T=5$ K, 35 °C)		m ³ /h	4,15	4,85
Flow switch			Included	Included
Water filter			Included	Included
Outdoor unit			U-200PZH2E8	U-250PZH2E8
Sound pressure	Cool / Heat (Hi)	dB(A)	59 / 61	59 / 63
Dimension	H x W x D	mm	1500 x 980 x 370	1500 x 980 x 370
Net weight		kg	117	128
Piping diameter	Liquid	Inch (mm)	3/8 (9,52)	1/2 (12,70)
	Gas	Inch (mm)	1 (25,40)	1 (25,40)
Pipe length range		m	5 ~ 90	5 ~ 60
Elevation difference (in / out)		m	30	30
Pre-charged pipe length		m	30	30
Additional gas amount		g/m	60	80
Water outlet temperature range	Cool Min ~ Max	°C	+5 ~ +15	+5 ~ +15
	Heat Min ~ Max	°C	+30 ~ +55	+30 ~ +55
Operating range	Cool Min ~ Max	°C	-15 ~ +46	-15 ~ +46
	Heat Min ~ Max	°C	-20 ~ +24	-20 ~ +24

1) Data refers to 7 °C leaving chilled water temperature and 35 °C ambient air temperature, according to EN14511 standard. 2) Data refers to 35 °C leaving warm water temperature and 7 °C ambient air temperature according to EN14511 standard. 3) Following COMMISSION REGULATION (EU) No 811/2013 for low-temperature heat pumps. Scale from A+++ to D. 4) Following COMMISSION REGULATION (EU) No 813/2013 for low-temperature heat pumps.

Professional solution

Water heat exchanger is compatible with R32 PACi.

Many air conditioning manufacturers are selling R32 systems and it is becoming the standard refrigerant for split type air conditioning, because R32 has a much lower global warming potential than R410A, and can also provide higher efficiency.

Quick installation with pre-assembled flow switch

The flow switches come pre-assembled with pipe fittings for ease of installation.

Operation down to -20 °C with no glycol as the heat exchanger is installed indoors.

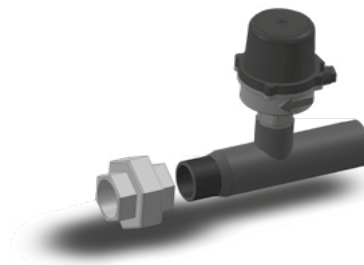

R22 Renewal. Fast, easy to install and cost effective

An important drive to further reduce the potential damage to our ozone.

It is often said that legislation is ruling our lives but sometimes it is there to help save lives. R22 phase out can be described as one of these and from Jan 1st 2010 the use of Virgin R22 refrigerant was banned within the European Union.



Panasonic is doing its part.

We at Panasonic are also doing our part – recognising that all finances are under pressure at the moment. Panasonic has developed a clean and cost effective solution to enable this latest legislation to offer less financial impact on your business.

The Panasonic renewal system allows good quality existing R22 or R410A pipe work to be re-used whilst installing high efficiency R32 systems.

By bringing a simple solution to the problem Panasonic can renew all Split Systems and PACi systems; and depending upon certain restrictions we don't even limit the manufacturer's equipment we are replacing.

By installing a high efficiency Panasonic R32 system you can benefit from around 30% running cost saving compared to the R22 system.

Yes...

1. Check the capacity of the system you wish to replace
2. Select from the Panasonic range the best system to replace it with
3. Follow the procedure detailed in the brochure and technical data

Simple...

Why renewal?

Unique R22 Renewal from Panasonic: Fast, easy to install and cost effective.

- Panasonic refrigerant oil doesn't react to the most common oil types used in air-conditioning systems. This ensures the mix of oil does not damage the units. Therefore installations are easier

- All Panasonic PACi units can be installed in R22 pipings, no specific models are available
- Up to 33 Bar! When there is any doubt about the strength of the piping, the maximum working pressure can be reduced to 33 Bar with a setting in the software of the outdoor unit

Reuse of existing piping (renewal design and installation)

Notes on reuse of existing refrigerant piping.

It is possible for each series of PZH and PZ series outdoor unit to reuse the existing refrigerant piping without cleaning when obtained under certain conditions. Make sure that the requirements under the section "Notes on reuse of existing refrigerant piping", "Measurement procedure for renewal" and "Refrigerant piping size and allowable piping length" will be satisfied in order to carry out.

Also, check the items with regard to section "Safety" and "Cleaning".

1. Prerequisite.

- If the refrigerant used for the existing unit is other than R22, R407C and R410A / R32, the existing refrigerant piping cannot be used.
- If the existing unit has another use than air conditioning, then existing refrigerant piping cannot be used.

2. Safety.

- If there is a hollow, crack or corrosion on the piping, make sure to install new piping.
- If the existing piping is other than capable of reuse of piping as shown in the flowchart, make sure to install new piping.
- In case of multiple operation, use our genuine branch piping for refrigerant R32.

A local supplier shall assume responsibility for the defects and hollows on the reuse of existing piping surface and recognition of reliability of the piping strength. There is no guarantee that we take responsibility for such damages.

The operational pressure of the refrigerant R32 becomes higher compared to R22 or R410A. In the worst case, a lack of compressive strength may lead to piping explosion.

3. Cleaning.

- When the refrigerant oil used for the existing unit is other than the listed below, make sure to install new piping or wash it thoroughly before reusing it.
[Mineral Oil] SUNISO, FIORE S, MS
[Synthesized oil] alkyl benzene oil (HAB, parallel freeze), ester oil, ether oil (PVE only)

If the existing unit is GHP type, it is necessary to wash the piping thoroughly.

- If the existing pipes in the outdoor and indoor units remain disconnected, make sure to install a new piping or wash it thoroughly before reusing it.
- If the discoloured oil or residue remains in the existing piping, make sure to install a new piping or wash it thoroughly before reusing it. See "Deterioration Criteria for Refrigerant Oil" in table 3.
- If the compressor of the existing air conditioner has a failure history, make sure to install a new piping or wash it through thoroughly before reusing it.

When reusing the existing piping as it is without removing dirt and dust, inadequate piping could result a renewal appliance in failure.



Notes on renewal for simultaneous operation of multiple units.

Only main pipe is applicable for using the different diameter size.

In case of different diameter size for the branch pipes, a new installation work for a standard size is necessary. Be sure to use our genuine branch piping for refrigerant R32.

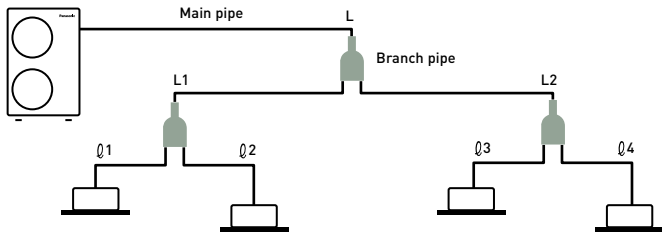

Notes on renewal for simultaneous operation of multiple units

Capacity class	Standard liquid pipe size	Standard gas pipe size
Type 50	∅ 6,35	∅ 12,70
Type from 60 to 140	∅ 9,52	∅ 15,88
Type 200	∅ 9,52	∅ 25,40
Type 250	∅ 12,70	∅ 25,40

- Only the main pipe L can be used among different diameter's existing piping
- Installation work as a standard size is capable for L1, L2, Q1 - Q4 piping
- Be sure to use our genuine branch piping for refrigerant R32

1. In case of single unit:
It is not necessary to charge with additional refrigerant until the chargeless pipe length in the table 2. If the pipe length is exceeding the charge less pipe length, charge with additional refrigerant amount per 1 m according to the equivalent length.
2. In case of simultaneous operation of multiple units:
Calculate the refrigerant charging amount according to the calculating method of the standard piping diameter. As to the additional refrigerant charging amount per 1 m, refer to the additional amount in the table 2.

Measurement procedure for renewal

Observe the following procedure when reusing the existing piping or carrying out renewal installation work. Flowchart of existing piping measures criteria for PZH and PZ series outdoor unit.

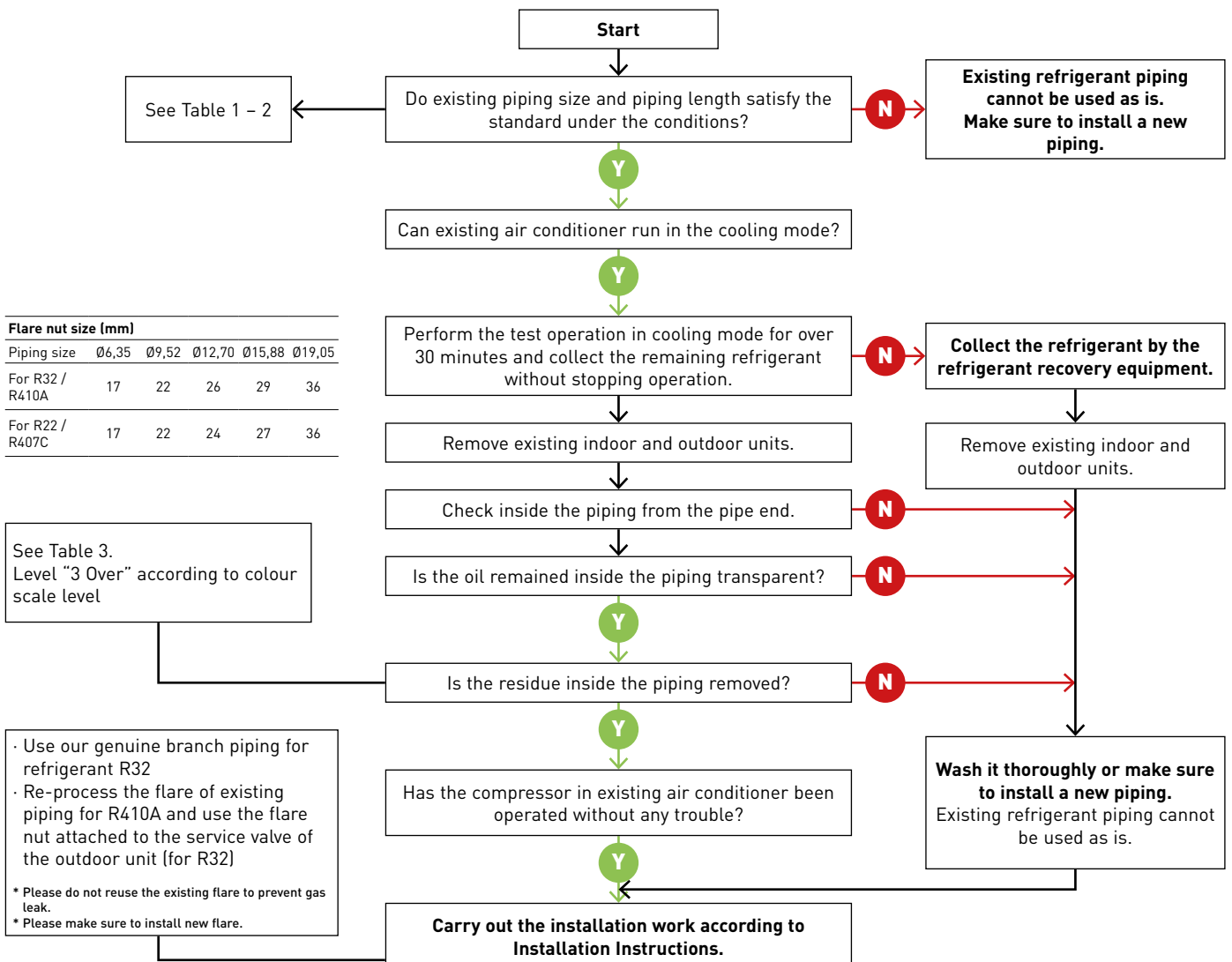

Refrigerant piping size and allowable piping length.

Check if reuse of existing refrigerant piping is possible based on the following chart.

The standards other than this one (difference of elevation, etc.) are identical to the requirements of ordinary refrigerant piping.

Table 1 - Reusable existing piping (mm)

Material	0								1/2 H, H*	
External diameter	Ø6,35	Ø9,52	Ø12,70	Ø15,88	Ø19,05	Ø22,22	Ø25,40	Ø28,58		
Thickness	0,80	0,80	0,80	1,00	1,00	1,00	1,00	1,00	1,00	1,00

* It is impossible to reuse the size of Ø19,05, Ø22,22, Ø25,4 and Ø28,58 for material O. Change to material 1/2H or material H.

Table 2 - 1 Refrigerant piping size: 2,5 - 14,0 kW type (mm)

Liquid pipe			Ø6,35				Ø9,52			Ø12,70	
Gas pipe			Ø9,52	Ø12,70	Ø15,88	Ø12,70	Ø15,88	Ø19,05	Ø15,88	Ø19,05	
PZH3	Type 36 ~ 60	Additional gas 15 g/m	✗	Standard 40 m (30 m)	✗	✗	✗	✗	✗	✗	✗
	Type 25		Tentative data								
PZ3	Type 36	Additional gas 10 g/m	✗	Standard 15 m (7,5 m)	✗	✗	✗	✗	✗	✗	✗
	Type 50	Additional gas 15 g/m	✗	Standard 20 m (7,5 m)	✗	✗	✗	✗	✗	✗	✗
	Type 60	Additional gas 15 g/m	✗	Standard 30 m (7,5 m)	✗	✗	✗	✗	✗	✗	✗
	Type 71	Additional gas 17 g/m	✗	✗	Standard 40 m (10 m)	✗	✗	✗	✗	✗	✗

Liquid pipe			Ø6,35				Ø9,52			Ø12,70	
Gas pipe			Ø9,52	Ø12,70	Ø15,88	Ø12,70	Ø15,88	Ø19,05	Ø15,88	Ø19,05	
PZH3	Type 71		✗	□ 10 m (10 m)	□ 10 m (10 m)	▽ 30 m (30 m)	Standard 50 m (30 m)	✗	□ 25 m (15 m)	□ 35 m (15 m)	✗
	Type 100 - 140		✗	✗	✗	✗	Standard 85 m (30 m)	⊙ 85 m (30 m)	□ 35 m (15 m)	□ 35 m (15 m)	
Additional gas			20 g/m				45 g/m			80 g/m	
PZ3	Type 100 - 140		✗	✗	✗	✗	Standard 50 m (30 m)	⊙ 50 m (30 m)	□ 25 m (15 m)	□ 25 m (15 m)	
Additional gas			20 g/m				45 g/m			80 g/m	
PZH2	Type 50		✗	Standard 40 m (30 m)	⊙ 40 m (30 m)	□ 20 m (15 m)	□ 20 m (15 m)	✗	✗	✗	✗
PZ2	Type 60 ~ 71		✗	▽ 10 m (10 m)	□ 10 m (10 m)	▽ 30 m (20 m)	Standard 50 m (20 m)	✗	□ 25 m (10 m)	□ 35 m (15 m)	✗
Additional refrigerant charging amount per 1 m			20 g/m				40 g/m			80 g/m	
PZH2	Type 60 ~ 71		✗	▽ 10 m (10 m)	□ 10 m (10 m)	▽ 30 m (30 m)	Standard 50 m (30 m)	✗	□ 25 m (15 m)	□ 35 m (15 m)	✗
	Type 100 - 140		✗	✗	✗	✗	Standard 75 m (30 m)	⊙ 75 m (30 m)	□ 35 m (15 m)	□ 35 m (15 m)	
PZ2	Type 100 - 140		✗	✗	✗	✗	Standard 50 m (30 m)	⊙ 50 m (30 m)	□ 25 m (15 m)	□ 25 m (15 m)	
Additional refrigerant charging amount per 1 m			20 g/m				50 g/m			80 g/m	

How to see table definition (example):

In case of type 71, standard size is liquid pipe Ø9,52 / gas pipe Ø15,88.

There is a limitation to liquid pipe Ø9,52 / gas pipe Ø12,70 and to liquid pipe Ø12,70 / gas pipe Ø15,88.

However, they are applicable for different diameter's pipes.

Table 2 - 2 Refrigerant piping size: 20,0 - 25,0 kW type (mm)

Liquid pipe			Ø9,52				Ø12,70			Ø15,88	
Gas pipe			Ø22,22	Ø25,40	Ø28,58	Ø22,22	Ø25,40	Ø28,58	Ø22,22	Ø25,40	Ø28,58
PZH	Type 200		▽ 80 m (30 m)	Standard 100 m (30 m)	⊙ 100 m (30 m)	▽ 50 m (15 m)	□ 50 m (15 m)	□ 50 m (15 m)	✗	✗	✗
	Type 250		✗	✗	✗	▽ 80 m (30 m)	Standard 100 m (30 m)	⊙ 100 m (30 m)	▽ 65 m (20 m)	□ 65 m (20 m)	□ 65 m (20 m)
Additional refrigerant charging amount per 1 m			40 g/m				80 g/m			120 g/m	

⊙ Allowable □ Limited piping length 50 m Maximum piping length
 ▽ Cooling capacity down ✗ Unallowable (50 m) Charge less piping length in a single connection

Table 3 - Deterioration Criteria for Refrigerant Oil

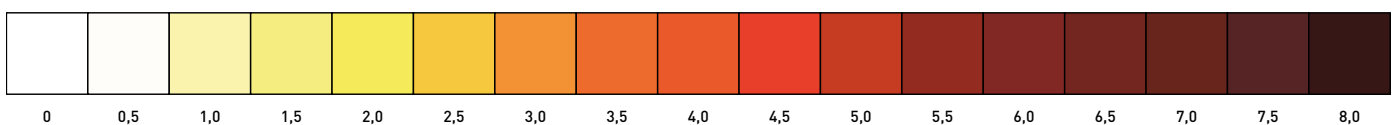

Accessories and control

Drain kits

Drain kit to suit outdoor units from 5,0 to 7,1 kW.

CZ-50DRS1

Drain kit to suit outdoor units from 10,0 to 25 kW.

CZ-140DRS1

Branch Pipes, Header



Branch pipe.

CZ-P224BK2BM



Branch pipe (from 22,4 kW to 68 kW).

CZ-P680BK2BM



Header.

CZ-P3HPC2BM

Outdoor accessories



Tray for condenser water compatible with outdoor elevation platform.

PAW-WTRAY



Outdoor elevation platform.

Dimension (H x W x D): 400 x 900 x 400 mm

PAW-GRDSTD40



Outdoor base ground support for noise and vibration absorption.

Dimension (H x W x D): 600 x 95 x 130 mm

Safe working load: 500 kg

PAW-GRDBSE20

Panels



Panel for 4 way 60x60 cassette - PY3.

CZ-KPY4



Standard panel for 4 way 90x90 cassette.

CZ-KPU3W



Econavi panel for 4 way 90x90 cassette.

CZ-KPU3AW

Sensors



Econavi energy saving sensor.

CZ-CENSC1



Remote temperature sensor.

CZ-CSRC3



Plenums

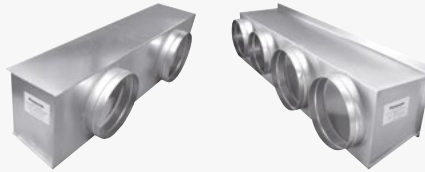

Air outlet plenum for S-3650PF3E.

CZ-56DAF2

Air outlet plenum for S-6071PF3E.

CZ-90DAF2

Air outlet plenum for S-1014PF3E.

CZ-160DAF2

Air outlet plenum for S-200PE3E5B and S-200PE2E5.

CZ-TREMIESPW705

Air outlet plenum for S-250PE3E5B and S-250PE2E5.

CZ-TREMIESPW706

VRF Smart Connectivity+



Remote controller Panasonic Net Con, RH, No PIR, R1/R2.

SER8150R0B1194

Remote controller Panasonic Net Con, RH, PIR, R1/R2.

SER8150R5B1194



Wireless ZigBee® Pro module / Green Com card.

VCM8000V5094P



Hotel room expansion module 14 indoor units.

HRCEP14R



Hotel room controller 28 indoor units.

HRCPB628R

Hotel room controller w/Display 42 indoor units.

HRCPDG42R



Door / window wireless sensor.

SED-WDC-G-5045



Wall / ceiling (motion) wireless sensor.

SED-MTH-G-5045



CO₂ sensor.

SED-C02-G-5045



Sensor with room temperature and humidity.

SED-TRH-G-5045



Water leakage sensor.

SED-WLS-G-5045



Cover frame. Silver.

FAS-00



Cover frame. White.

FAS-01



Cover frame. Glossy translucent white.

FAS-03



Cover frame. Light tan wood.

FAS-05



Cover frame. Dark brown wood.

FAS-06



Cover frame. Dark black wood.

FAS-07



Cover frame. Brushed steel finish.

FAS-10

Controller and touch controllers for hotels with dry contacts

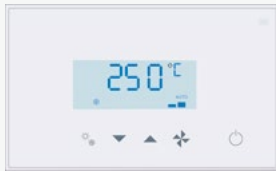

Modbus RS-485 touch room controller with I/O, white.

PAW-RE2C4-MOD-WH

Touch display control with 2 digital inputs, white.

PAW-RE2D4-WH

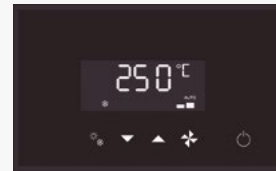

Modbus RS-485 touch room controller with I/O, black.

PAW-RE2C4-MOD-BK

Touch display control with 2 digital inputs, black.

PAW-RE2D4-BK

Hotel sensors for dry contacts



Wall motion sensor 24 V.

PAW-WMS-DC

Wall motion sensor 240 V AC.

PAW-WMS-AC



Ceiling motion sensor 24 V.

PAW-CMS-DC

Ceiling motion sensor 240 V AC.

PAW-CMS-AC



Power supply 24 V.

PAW-24DC



Door or window contact.

PAW-DWC

Centralised controls



System controller for 64 indoor units with weekly timer.

CZ-64ESMC3



Central ON / OFF controller, up to 16 groups, 64 indoor units.

CZ-ANC3



Intelligent controller (touch screen/web server) to control up to 256 indoors with included load distribution ratio (LDR).

CZ-256ESMC3

Panasonic AC Smart Cloud



+ ALL REFERENCES RELATED TO AC SMART CLOUD IS IN THE DEDICATED PAGE

Panasonic AC Smart Cloud. Cloud internet control. Up to 128 groups. Controls 128 units.

CZ-CFUSCC1

BMS interface with S-Link



Modbus RTU and TCP interface for 16 indoor units.

PAW-AC2-MBS-16P

Modbus RTU and TCP interface for 64 indoor units.

PAW-AC2-MBS-64P

Modbus RTU and TCP interface for 128 indoor units.

PAW-AC2-MBS-128P

KNX interface for 16 indoor units.

PAW-AC2-KNX-16P

KNX interface for 64 indoor units.

PAW-AC2-KNX-64P



BACnet IP and MSTP interface for 16 indoor units.

PAW-AC2-BAC-16P

BACnet IP and MSTP interface for 64 indoor units.

PAW-AC2-BAC-64P

BACnet IP and MSTP interface for 128 indoor units.

PAW-AC2-BAC-128P

Accessories interfaces



Commercial Wi-Fi Adaptor.

CZ-CAPWFC1



KNX interface (Intesis).

PAW-RC2-KNX-1i



Modbus RTU interface (Intesis).

PAW-RC2-MBS-1



Modbus RTU interface to control 4 indoor/groups (Intesis).

PAW-RC2-MBS-4



BACnet IP and MSTP (Intesis).

PAW-RC2-BAC-1





NEW KNX interface (Airzone).













PAW-AZRC-KNX-1

 <p>NEW Modbus RTU interface (Airzone).</p> <p>----- PAW-AZRC-MBS-1</p>	 <p>NEW BACnet IP and MSTP interface (Airzone).</p> <p>----- PAW-AZRC-BAC-1</p>	 <p>RAC interface adapter for integration into S-Link, plus external input and alarm/status output (for YKEA units).</p> <p>----- CZ-CAPRA1</p>
---	---	---

Centralised controls. Connection with general equipment

 <p>Adaptor for ON / OFF control of external devices.</p> <p>----- CZ-CAPC3</p>	 <p>Demand control for Mini ECOi and PACi outdoor units.</p> <p>----- CZ-CAPDC3</p>	 <p>Mini series parallel device controlling indoor units, maximum 1 group and 8 indoor unit.</p> <p>----- CZ-CAPBC2</p>	 <p>Communication Adaptor. Up to 128 groups. Controls 128 units.</p> <p>----- CZ-CFUNC2</p>
---	---	--	---

Individual controls

 <p>NEW CONEX wired remote controller (non-wireless), white.</p> <p>----- CZ-RTC6W ¹⁾</p>	 <p>NEW CONEX wired remote controller with Bluetooth®, white.</p> <p>----- CZ-RTC6WBL ¹⁾</p>	 <p>NEW CONEX wired remote controller with Wi-Fi and Bluetooth®, white.</p> <p>----- CZ-RTC6WBLW ^{1) 2)}</p>	 <p>CONEX wired remote controller (non-wireless), black.</p> <p>----- CZ-RTC6</p>
 <p>CONEX wired remote controller with Bluetooth®, black.</p> <p>----- CZ-RTC6BL</p>	 <p>CONEX wired remote controller with Wi-Fi and Bluetooth®, black.</p> <p>----- CZ-RTC6BLW ²⁾</p>	 <p>Design wired remote controller with Econavi function and datanavi.</p> <p>----- CZ-RTC5B</p>	 <p>Infrared remote controller for wall-mounted.</p> <p>----- CZ-RWS3</p>
 <p>Infrared remote controller and receiver for 4 way 60x60 cassette - PY3 with panel.</p> <p>----- CZ-RWS3 + CZ-RWRY3</p>	 <p>Infrared remote controller and receiver for 4 way 90x90 cassette.</p> <p>----- CZ-RWS3 + CZ-RWRU3W</p>	 <p>Infrared remote controller and receiver for ceiling.</p> <p>----- CZ-RWS3 + CZ-RWRT3</p>	 <p>Infrared remote controller and receiver for all indoor units.</p> <p>----- CZ-RWS3 + CZ-RWRC3</p>

Accessories PCB

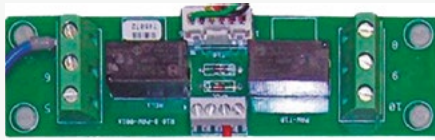

T10 interface PCB with digital and relay connections.

PAW-T10



PCB for server room application, control up to 4 indoor unit groups, redundancy, backup, etc.

PAW-PACR4



Connector to PACi NX indoor unit's PCB to provide OPT functions.

PAW-OPT-NX

Accessories cables

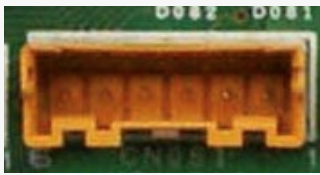

Cable for all the T10 functions.

CZ-T10



Cable to operate external EC fan.

PAW-FDC



Cable for all option monitoring signals.

PAW-OCT



Cable with force thermo OFF/leakage detection.

PAW-EXCT

PRO-HT Tank accessories

Tank controller for PACi system.

PAW-VP-RTC5B-PAC

Additional heater.

PAW-IU39

1) Available in Autumn 2023. 2) Only compatible with PACi NX Series.

ECO i EX

ECO i

ECO G



Commercial VRF Systems

Professional solutions for commercial projects.

Panasonic VRF Systems are specifically designed for energy saving, easy installation and high efficiency performance. A wide range of outdoor and indoor unit models offer unique features which are designed for the most demanding offices and large buildings.



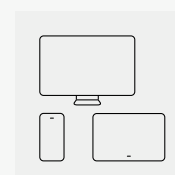
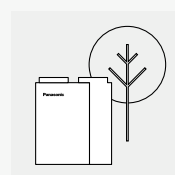
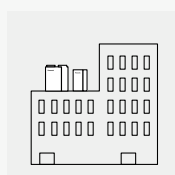
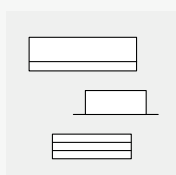
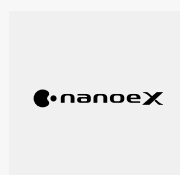



VRF highlighted features	→ 226	Design support software for VRF	→ 300
Panasonic: delivering TOP energy efficiencies for many years	→ 228	R22 Renewal	→ 301
Bringing nature's balance indoors	→ 230	ECOi and ECO G indoor units range	→ 302
Panasonic VRF: TOP in comfort	→ 232	U2 type 4 way 90x90 cassette · R32 / R410A	→ 305
Solutions for Restaurants	→ 234	Y3 type 4 way 60x60 cassette · R32 / R410A	→ 306
Your entire hotel with superior comfort, control and savings too	→ 236	L1 type 2 way cassette · R410A	→ 307
Innovative solutions for retail	→ 238	D1 type 1 way cassette · R410A	→ 308
Best efficiency ECOi Series from Panasonic	→ 242	F3 type variable static pressure adaptive duct · R32 / R410A	→ 309
Mini ECOi LZ2 Series R32	→ 244	F2 type variable static pressure hide-away · R410A	→ 310
Mini ECOi LE Series	→ 250	M1 type slim variable static pressure hide-away concealed duct · R32 / R410A	→ 311
ECOi EX. The Game Changer	→ 256	E2 type high static pressure hide-away · R410A	→ 312
Slim 3-Pipe control box kit / Multiple connection type	→ 273	Heat recovery with DX coil · R410A	→ 313
Eurovent certified technical data	→ 278	T2 type ceiling · R410A	→ 314
ECO G, the gas driven VRF	→ 280	K2 type wall-mounted · R32 / R410A	→ 315
Panasonic GHP/EHP Hybrid System	→ 290	G1 type floor console · R410A	→ 316
Water heat exchanger for hydronic applications	→ 294	P1 type floor-standing · R410A	→ 317
Leak detection and automatic refrigerant Pump Down for R410A refrigerant	→ 298	R1 type concealed floor-standing · R410A	→ 318
VRF outdoor units range	→ 240	Hydrokit for ECOi, water at 45 °C · R410A	→ 319
Mini ECOi LZ2 Series 4 to 6 HP · R32	→ 248	PRO-HT Tank Series for ECOi	→ 320
Mini ECOi LZ2 Series 8 and 10 HP · R32	→ 249	Fan coils highlighted features	→ 322
Mini ECOi LE2 Series 4 to 6 HP · R410A	→ 254	Smart fan coils	→ 323
Mini ECOi LE1 Series 8 and 10 HP · R410A	→ 255	Fan coils - ducted	→ 324
2-Pipe ECOi EX ME2 Series	→ 267	Fan coils - wall-mounted	→ 325
3-Pipe ECOi EX MF3 Series	→ 276	Accessories and control	→ 326
2-Pipe ECO G GE3 Series	→ 286	Dimensions and tube sizes of branches and headers for 2-Pipe ECOi EX ME2 and Mini ECOi Series	→ 334
3-Pipe ECO G GF3 Series	→ 289	Dimensions and tube sizes of branches and headers for 3-Pipe ECOi EX MF3 Series	→ 336
2-Pipe Hybrid GHP/EHP	→ 293		
ECOi 2-Pipe with water heat exchanger	→ 296		
ECO G with water heat exchanger	→ 297		



VRF highlighted features

Panasonic provides an extensive range of solutions for medium and large sized buildings, combining the best options to satisfy all needs and site restrictions.



ECOi. Electrical VRF				ECO G. Gas Powered VRF	
2-Pipe Mini ECOi LZ2 · R32	2-Pipe Mini ECOi LE2 / LE1 · R410A	2-Pipe ECOi EX	3-Pipe ECOi EX	2-Pipe ECO G GE3	3-Pipe ECO G GF3
					
Capacity range					
4 - 10 HP	4 - 10 HP	8 - 80 HP	8 - 48 HP	16 - 60 HP	16 - 25 HP
Extreme temperatures operation					
-20 °C (heating) / 52 °C (cooling)	-20 °C (heating) / 46 °C (cooling)	-25 °C (heating) / 52 °C (cooling)	-20 °C (heating) / 52 °C (cooling)	-21 °C (heating) / 43 °C (cooling)	-21 °C (heating) / 43 °C (cooling)
Maximum number of connectable indoor units					
16 ¹⁾	15	64	52	64	24
Indoor to outdoor connection ratio					
50 ~ 150%	50 ~ 130%	50 ~ 200%	50 ~ 150%	50 ~ 200% ²⁾	50 ~ 200%
Indoor units					
All (check restrictions)					
Controls					
All					
Other ranges integration					
PACi range full control integration + Domestic range integration by accessory					

¹⁾ For 6 HP model. ²⁾ 50 ~ 200% only when one outdoor unit is installed. In other cases 50 ~ 130%.

Uniquely, you can choose from both electric and gas-powered VRF systems from Panasonic, delivering the best choice and flexibility for our customers.

Providing a large choice of indoor units, you can also connect water heat exchangers, air handling units and ventilation units with or without a heat exchanger. And all managed from a simple and powerful stand-alone remote control, centralised controls or cloud connection with 3G embedded.

This cutting edge control technology is called VRF Smart Connectivity, combining the expertise of VRF communication and a leading BEMS company to maximise comfort and efficiency while also reducing installation costs.

Panasonic ECOi is Eurovent certified. Panasonic's VRF systems - ECOi range is now certified by Eurovent*. The Eurovent certification verifies the performance ratings of heating and cooling systems following European standards. Those data provides products efficiency with full transparency for the benefit of customers and professionals.



* Reference website: <https://www.eurovent-certification.com/en>.

Energy saving



Refrigerant gas R32.

R32 Our heat pumps containing R32 refrigerant show a drastic reduction in the value of Global Warming Potential (GWP).



Inverter Plus system.

Inverter Plus system classification highlights Panasonic's highest performing systems.



Panasonic R2 rotary compressor.

Designed to withstand extreme conditions, it delivers high performance and efficiency.



All Inverter compressors.

Multiple large-capacity all Inverter compressors (more than 14 HP). Two independently controlled Inverter compressors achieve high efficiency. Redesigned components in the body provide performance improvement especially in the rated cooling condition and EER performance.



High COP.

High efficiency models performs higher COP than standard units and standard combinations.



Gas powered.

ECO G technology offers the best in energy efficiency. ECO G gas VRF is specially designed for buildings where the electricity is restricted or CO₂ emissions must be reduced.



Commercial Econavi.

Intelligent human activity sensor and sunlight sensor technologies that can detect and reduces the waste of energy by optimising air conditioner operation according to room conditions. With just one touch of a button, you can save energy.



ErP 2018.

Compliant following COMMISSION REGULATION (EU) No2016/2281.

High performance and indoor air quality



Bluefin.

Panasonic has extended the life of its condensers with an original anti-rust coating.



Down to -10 °C in cooling mode.

The air conditioner works in cooling mode when the outdoor temperature of -10 °C.



Down to -25 °C in heating mode.

The air conditioner works in heat pump mode when the outdoor temperature is as low as -25 °C.



Cooling with outdoor temperature up to 52 °C.

The ECOi EX system works in cooling mode with performance data at outdoor temperature up to 52 °C.



Automatic restart.

Automatic restart function for power failure. Even when power failure occurs, preset programmed operation can be reactivated once power is resumed.



R22 renewal.

The Panasonic renewal system allows good quality existing R22 pipe work to be re-used whilst installing high efficiency R410A systems.



nanoe™ X.

Technology with the benefits of hydroxyl radicals has the capacity to inhibit pollutants, viruses, and bacteria to clean and deodorise.



Self-diagnosing function.

By using electronic control valves past warnings are stored. This makes it easier to diagnose malfunctions, reducing service labour and therefore costs.



Automatic fan operation.

Convenient microprocessor control automatically adjusts fan speed to High, Medium or Low, corresponding to room sensor and maintains comfortable air flow throughout the room.



Mild Dry.

By intermittent control of compressor and indoor unit's fan, "Mild Dry" gives you comfort. It realizes efficient dehumidification according to room temperature.



Comfortable auto-flap control.

When the unit is first turned on, flap position is automatically adjusted in accordance with the cooling or heating operation.



Air Sweep.

The air sweep function moves the flap up and down in the air outlet, directing air in a "sweeping" motion around the room and providing comfort in every corner.



Built-in drain pump.

Maximum head 50 cm (or 75 cm for U type) from the bottom of the unit.



Filter included.

Hide-away with filter included.



DHW.

With PRO-HT Tank you can also heat your domestic hot water at a very low cost with the optional hot water cylinder.



High temperature.

With PRO-HT Tank, maximum water outlet temperature up to 65 °C.



-20 °C operating range.

The PRO-HT Tanks work with an outdoor temperature is as low as -20 °C.



5 Years compressor warranty.

We guarantee the outdoor unit compressors in the entire range for five years.

High connectivity



Domestic integration to S-Link - CZ-CAPRA1.

Can connect RAC range to S-Link. Full control is now possible.



Internet control.

A next generation system providing user-friendly remote control of air conditioning or heat pump units from everywhere, using a simple Android™ or iOS smartphone, tablet or PC via the internet.



BMS Connectivity.

The communication port can be integrated into the indoor unit and provides easy connection to, and control of, your Panasonic heat pump to your home or building management system.



Panasonic AC Smart Cloud.

The AC Smart Cloud from Panasonic allows you to have complete control of all your installations. In a simple click, receive status updates from all your units in real-time, preventing breakdowns and optimising costs.

Panasonic: delivering TOP energy efficiencies for many years



Particularly suitable for retail, hotels and office applications.

Outstanding efficiency at part load conditions:

Panasonic ECOi EX model covers down 30% part load with extremely high efficiency.

EER comparison of Panasonic 2-Pipe ECOi EX ME2 at different partial loads

Load %	100%	80%	60%	50%	40%	30%
18 HP High Efficiency model	4,54	5,30	6,37	7,12	8,23	6,93
18 HP Space saving model	3,38	3,97	4,75	5,25	5,13	4,97

Conditions: Outdoor temperature 35 °C DB, Room temperature 19 °C WB.

COP comparison of Panasonic 2-Pipe ECOi EX ME2 at different partial loads

Load %	100%	80%	60%	50%	40%	30%
18 HP High Efficiency model	3,89	5,42	6,90	6,94	6,59	6,11
18 HP Space saving model	3,43	4,90	6,36	6,59	6,33	5,92

Conditions: Outdoor temperature 0 °C WB, Room temperature 20 °C DB.

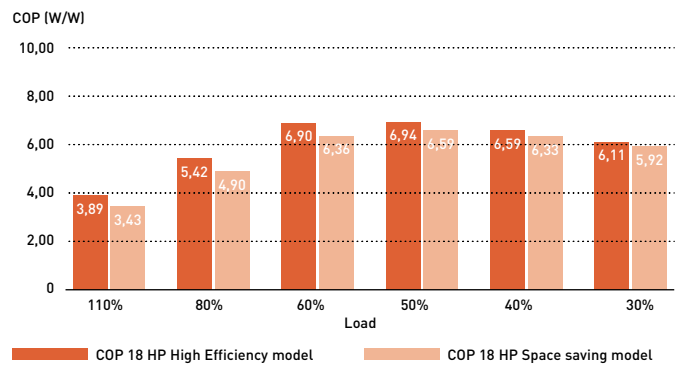
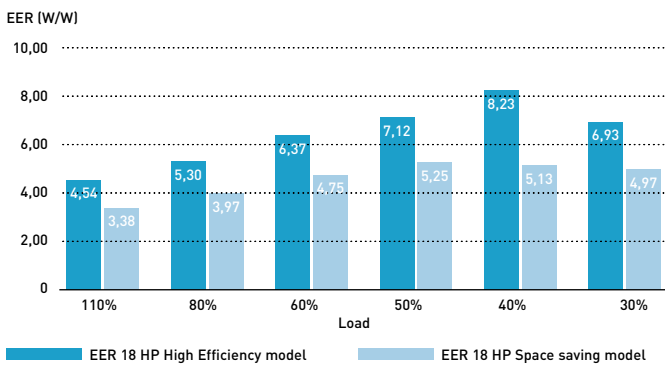

* Data from Panasonic official technical data book.

Excellent SEER and SCOP values for VRF 2 and 3-Pipe

Panasonic have a extremely high SEER and SCOP values following LOT21 (seasonal space cooling / heating energy efficiency by COMMISSION REGULATION (EU) 2016/2281).

HP	Mini ECOi (LZ)					Mini ECOi (LE)					2-Pipe				3-Pipe							
	4	5	6	8	10	4	5	6	8	10	8	10	12	16	18	20	8	10	12	14	16	
SEER	8,50	8,12	7,71	7,56	7,08	7,85	7,48	7,25	6,27	6,37	7,43	6,96	6,74	7,23	6,43	7,56	7,03	7,02	7,05	6,39	6,69	6,02
$\eta_{s,c}$	337,0	321,8	305,4	299,4	280,2	311,0	296,2	286,8	247,9	251,8	294,3	275,4	266,6	286,0	254,3	299,2	278,2	277,7	278,9	252,7	264,4	237,7
SCOP	5,05	4,61	4,59	4,59	4,60	4,87	4,40	4,24	4,24	4,31	4,79	4,27	4,72	4,28	4,05	4,29	4,09	4,85	4,25	4,27	4,13	3,81
$\eta_{s,h}$	199,0	181,4	180,6	180,6	181,0	191,8	172,9	166,7	166,4	169,5	188,4	167,6	185,8	168,2	159,0	168,7	160,4	190,9	166,8	167,8	162,1	149,3

Efficient defrost operation

Panasonic uses the second unit to defrost the first unit. This makes the system more efficient during defrost and does not affect comfort.

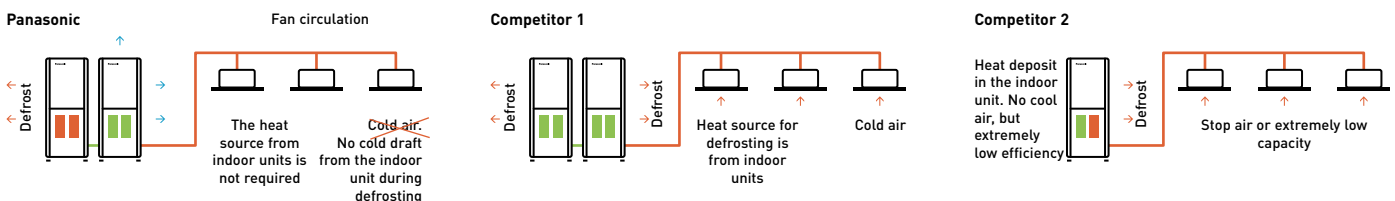

Panasonic ECOi operates down to -25 °C

This unique feature demonstrate the supremacy of Panasonic ECOi EX Series.

Panasonic use the second unit to defrost the first unit. This makes the system more efficient during defrost and does not affect the comfort.

Outside air temperature (up to 15 [°C WB]).

Lowest operating outdoor temperature in the market -25 °C

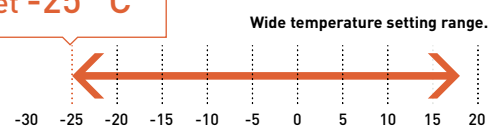

Bringing nature's balance indoors



nanoe™ X, technology with the benefits of hydroxyl radicals.

Abundant in nature, hydroxyl radicals (also known as OH radicals) have the capacity to inhibit pollutants, viruses, and bacteria to clean and deodorise. nanoe™ X technology can bring these incredible benefits indoors so that hard surfaces, soft furnishings, and the indoor environment can be a cleaner and more pleasant place to be, whether at home, work, or visiting hotels, shops and restaurants etc.



Panasonic's nanoe™ X technology takes this a step further and brings nature's detergent – hydroxyl radicals – indoors to help create an ideal environment

Thanks to the nanoe™ X properties, several types of pollutants can be inhibited such as certain types of bacteria, viruses, mould, allergens, pollen and certain hazardous substances.

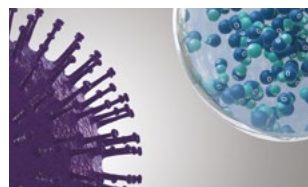

1 | nanoe™ X reliably reaches pollutants.



2 | Hydroxyl radicals denature pollutants' proteins.

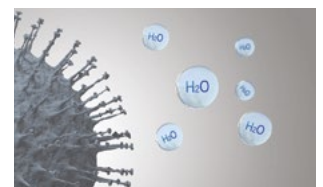

3 | Pollutants activity is inhibited.

What is unique about nanoe™ X?

Effective on fabrics and surfaces.

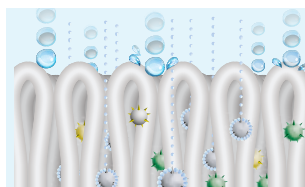

1 | At one billionth of a metre, nanoe™ X is much smaller than steam and can deeply penetrate cloth fabrics to deodorise.

Longer lifespan.



2 | Contained in tiny water particles, nanoe™ X has a long lifespan, which is about 600 seconds, to spread easily around the room.

Huge quantity.



3 | nanoe X Generator Mark 2 produces 9,6 trillion hydroxyl radicals per second. Greater amounts of hydroxyl radicals contained in nanoe™ X lead to higher performance on inhibition of pollutants.

Maintenance-free.

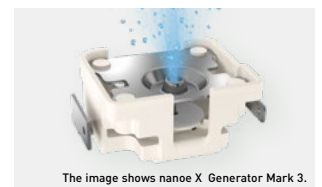

4 | No service and maintenance required. nanoe™ X is a filter free solution that does not require maintenance, as its atomisation electrode is enveloped with water during its generation process and it is made with Titanium.

7 effects of nanoe™ X – Panasonic unique technology

Deodorises

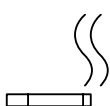

Odours

Capacity to inhibit 5 types of pollutants

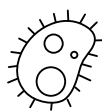

Bacteria and viruses

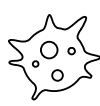

Mould



Allergens



Pollen



Hazardous substances



Skin and hair

* Refer to <https://aircon.panasonic.eu> for more details and validation data.

nanoe™ X has evolved again - the nanoe X Generator Mark 3.

The latest of the continuously evolving nanoe™ X technology, it has the largest amount of hydroxyl radical in the history of nanoe™ which generates 48 trillion hydroxyl radical per second, 100 times the hydroxyl radical contained in traditional nanoe™. The increased number of hydroxyl radical, which are the key to nanoe™ cleaning power, means you can expect an even higher level of performance.



First nanoe™ device was developed by Panasonic in 2003

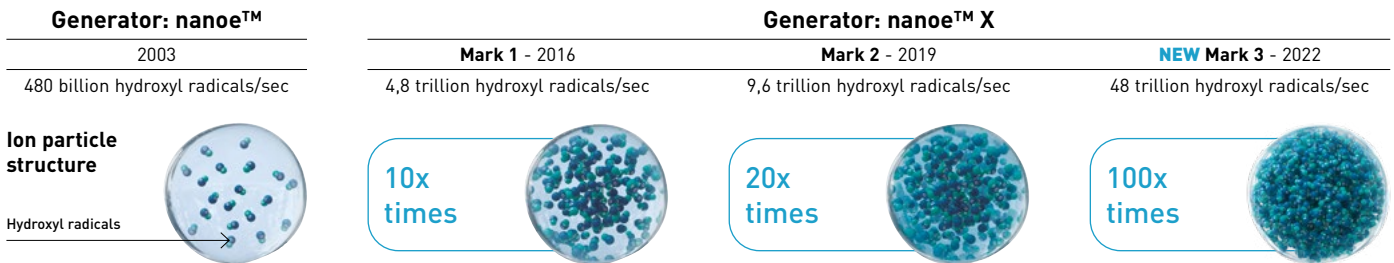

Higher concentration, even in large spaces

Greater effectiveness even in large spaces of more than 100 m².

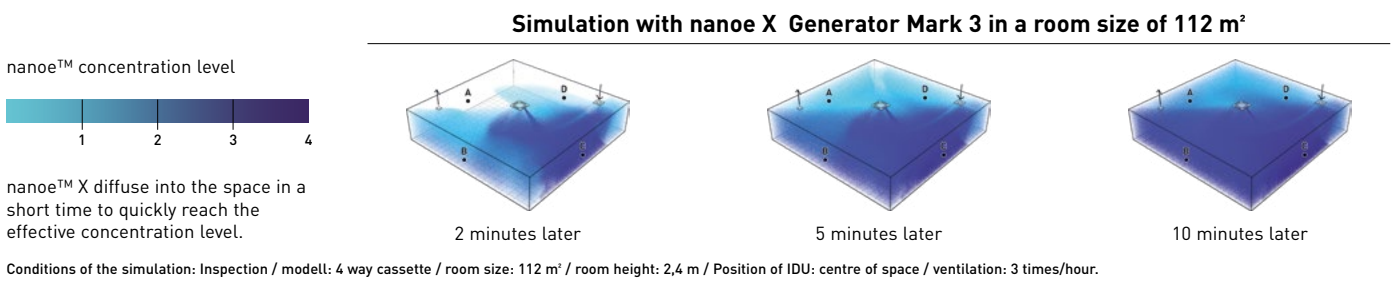

Effectiveness in large space with Generator Mark 3

Inhibits virus.

An air conditioner equipped with nanoe X Generator Mark 3 inhibits activity of adhered virus (Bacteriophage) by 98,81% in 4 hours¹⁾.

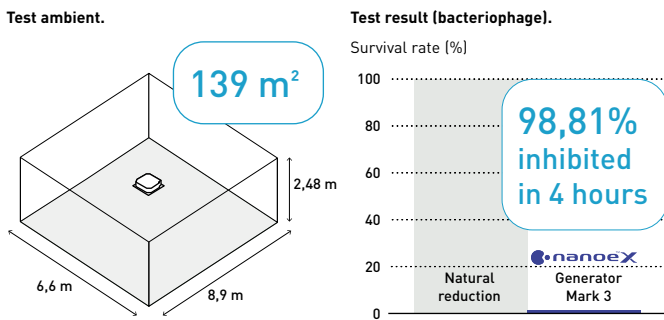

Inhibits pollen.

The result of nanoe X Generator Mark 3. Inhibits pollen in 1/4 the time of nanoe X Generator Mark 2²⁾.

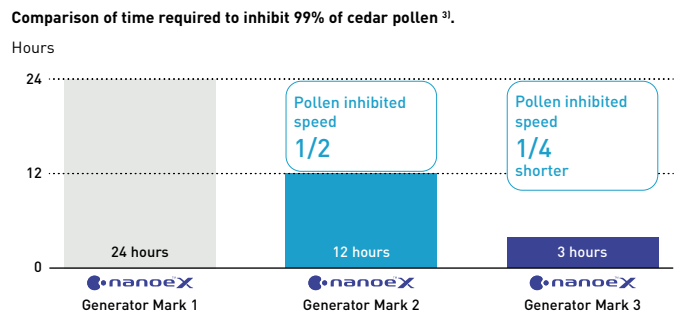

1) Testing organisation: SGS Inc / Test subject: Adhered Bacteriophage / Test volume: Approx. 139 m² large space (6,6 x 8,9 x 2,48 m). Test result: Inhibited 98,81% in 4 hours. Test report no.: SHES210901902583.
 2) Effect after 3 hours in a test space of approx. 24 m². The figures are not the results of testing in an actual operating space. 3) nanoe X Generator Mark 1: [Testing organisation] Panasonic Product Analysis Center [Test method] ELISA method of measuring allergens adhering to fabric in a test room (approx. 24 m²) [Method of inhibition] Release of nanoe™ [Target] Adhered allergen (cedar pollen) [Test Result] Inhibition of 99% or more in 24 hours (4AA33-151001-F01). nanoe X Generator Mark 2: [Testing organisation] Panasonic Product Analysis Center, [Test method] ELISA method of measuring allergens adhering to fabric in a test room (approx. 24 m²) [Method of inhibition] Release of nanoe™ [Target] Adhered allergen (cedar pollen) [Test Result] Inhibition of 99% or more in 12 hours confirmed (L19YA009). nanoe X Generator Mark 3: [Testing organisation] Panasonic Product Analysis Center [Test method] ELISA method of measuring allergens adhering to fabric in a test room (approx. 24 m²) [Method of inhibition] Release of nanoe™ [Target] Adhered allergen (cedar pollen) [Test Result] Inhibition of 99% or more in 3 hours (H21YA017-1).

Panasonic Heating & Cooling Solutions is incorporating nanoe™ technology in a wide range of equipment



U2 type 4 way 90x90 cassette.
Built-in nanoe X Generator Mark 2 / 3.



F3 type adaptive duct.
Built-in nanoe X Generator Mark 2 / 3.



Y3 type 4 way 60x60 cassette.
Built-in nanoe X Generator Mark 3.



G1 type floor console.
Built-in nanoe X Generator Mark 1.



Ceiling mounted air-e nanoe X Generator.
Built-in nanoe X Generator Mark 1.

Panasonic VRF: TOP in comfort

Since 2006, all Panasonic VRF systems have included special VET technology, with variable refrigerant temperature control, as standard.



Variable Evaporation and Condensation Temperature.

Our 'smart logic' system checks the temperature every 30 seconds, automatically adjusting the refrigerant temperature according to actual demand and outdoor conditions. This ensures better energy performance at all times.

Temperature varies from 16 °C to 3 °C.

Similarly, the condensation temperature is also variable and is adjusted to the room thermal load, within a range of 33 - 55 °C.

Refrigerant evaporation temperature (°C).

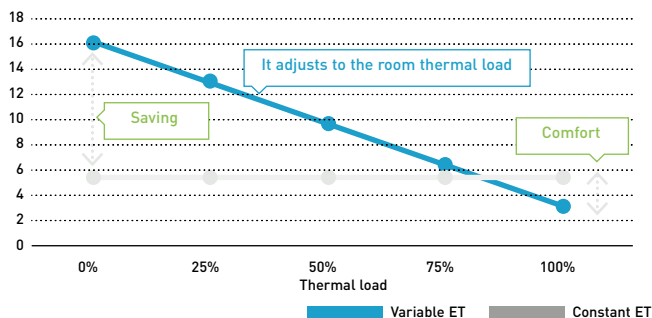

Refrigerant condensation temperature (°C).

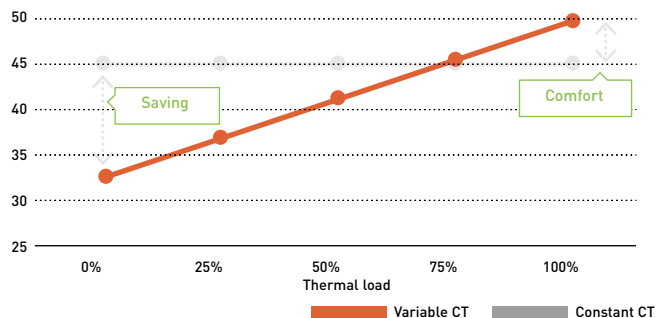

Example of cooling mode (similarly applicable to heating mode).

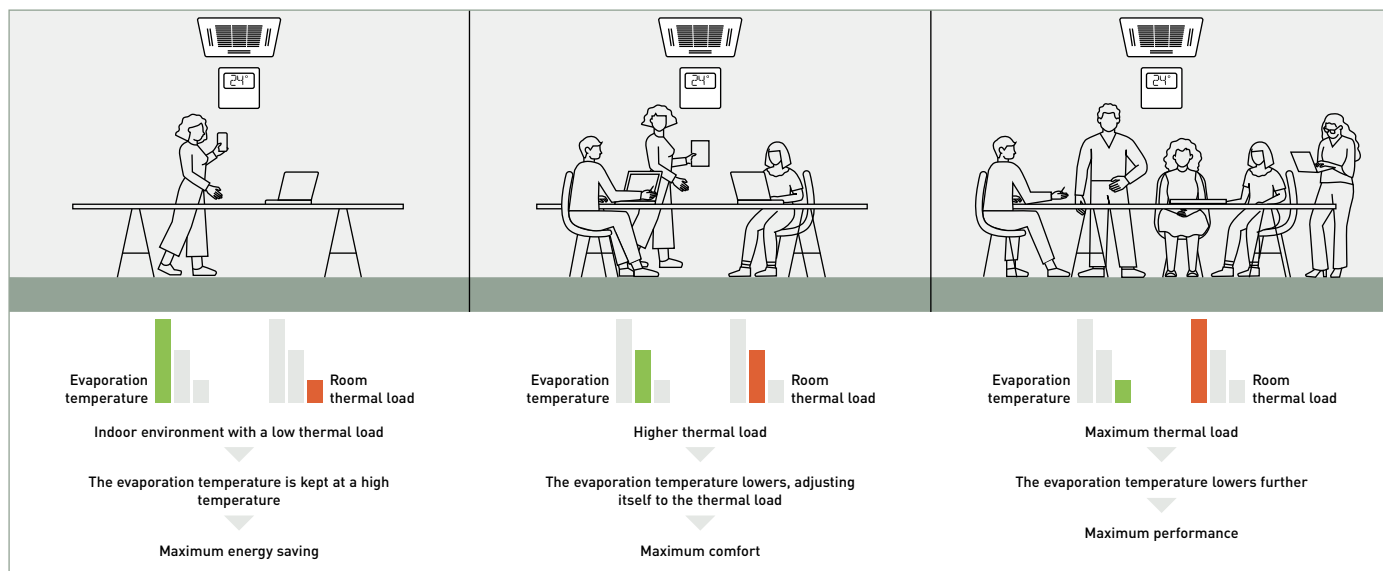

Technical focus on variable temperatures

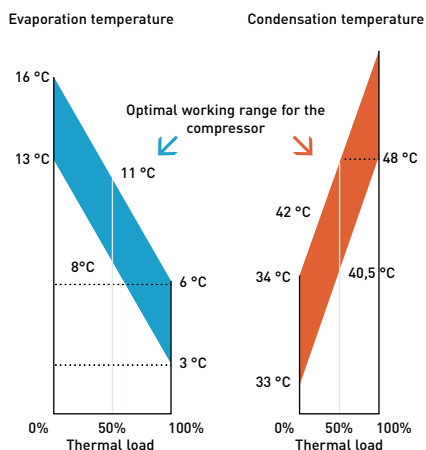

Control of the discharge temperature

This special function is available in all of Panasonic VRF systems' indoor units to guarantee maximum comfort for the end user. For example, in cooling mode, if the temperature of the discharged air was below 10 °C, the user may feel discomfort, just as he would do in heating mode if the temperature was far too high. With the Panasonic control of the discharge air temperature, this can be adjusted within a cooling range of 7 - 22 °C.

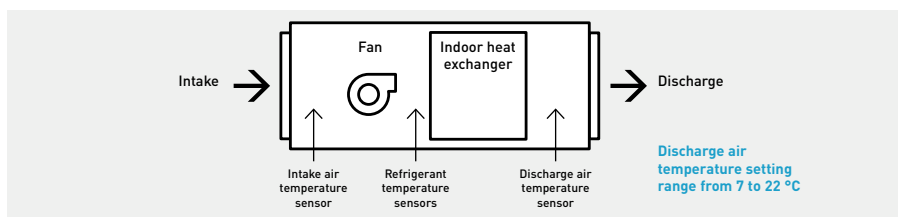

Benefits:

- The air will never be too cold or too warm
- Available in cooling and in heating
- Higher comfort
- Energy saving
- It prevents the formation of condensation within ducts and vents, improving levels of hygiene

Solutions for Restaurants

Full heating, cooling and DHW solutions for Restaurants.



1a Gas VRF. ECO G.

ECO G gas VRF is designed for buildings where the electricity is restricted or CO₂ emissions must be reduced. Sanitary hot water is produced for free, all year round.



1b Electric VRF. ECOi EX and Mini ECOi.

ECOi electrical VRF is specifically designed for the most demanding hotels. High efficiency system. Extended operating range to provide heating at outdoor temperature as low as -25 °C (2-Pipe ECOi EX). Suitable for refurbishment projects.

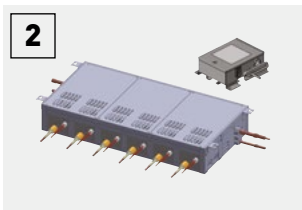

2 3-Pipe control box kit.

Heat Recovery box to connect multiple indoor units with just one box, 4, 6 and up to 8 indoor units or groups
This is good advantage in the restaurants, where space for connecting several boxes is limited.

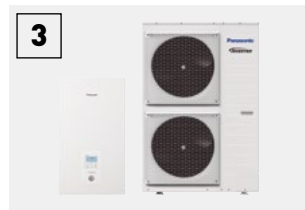

3 Aquarea T-CAP.

Ideal for heating, cooling and for production of big quantities of hot water at 65 °C, Aquarea have a extremely quick return on investment and a low CO₂ footprint.



4 Water heat exchanger for ECOi and ECO G. Water up to 55 °C.

Producing hot water, compatible with both ECOi and ECO G, heat pump outdoor units.



5 Air handling unit kits for efficient ventilation.

The AHU connection kit is specially designed to improve the efficiency of the pre-heating or pre-cooling ventilation process.



6 Adaptive ducted with nanoe™ X.

Super silent units deliver the ideal air supply. Units available from 1,5 kW providing precise temperature control even in small rooms. 2 installation possibilities (horizontal / vertical) with high ESP 150 Pa allows for flexible installation. nanoe™ X is built-in as standard.



7 Mini Cassette.

The Y3 type 4 way 60x60 cassette unit has modern and stylish panel design which matches with any type of the building design.



8 Control your way.

Wide variety of controls, from simple user control to full system control via remote access functionality. Touch panel and consumption control.



9 Air curtain with DX coil.

The Panasonic range of air curtains is designed for smooth operation and efficient performance.



10 Protocol friendly.

Great flexibility for integration into your KNX / Modbus / LonWorks / BACnet projects allows fully bi-directional monitoring and control of all the functioning parameters. Range of solutions to control locally or remotely the full system in bi-directional mode.



11 Panasonic AC Smart Cloud / Service Cloud.

Taking your business under control. The Service function makes maintenance work simpler.



12 Condensing unit with natural refrigerant.

Panasonic CO₂ unit is the natural choice for showcases and cold rooms in restaurants. Always fresh foods from a future-proof refrigeration technology, without any contamination risk.

Highly efficient at part load conditions.

Panasonic has solutions for optimising the installation of cooling, heating and DHW production in restaurants. While the kitchen needs cooling, heating is needed for DHW and also for heating the public area, with the advantage of 100% fresh air that removes odours. Combining all these needs smartly with Panasonic technology results in a simple and flexible system adaptable to any restaurant requests, with lower utility bills. Additionally, Panasonic is offering the unique solution for areas where electric power is limited, using ECO G. VRF units powered mainly by Natural Gas or Propane, bringing comfort and DHW anywhere.

For chiller options, please check chiller section.

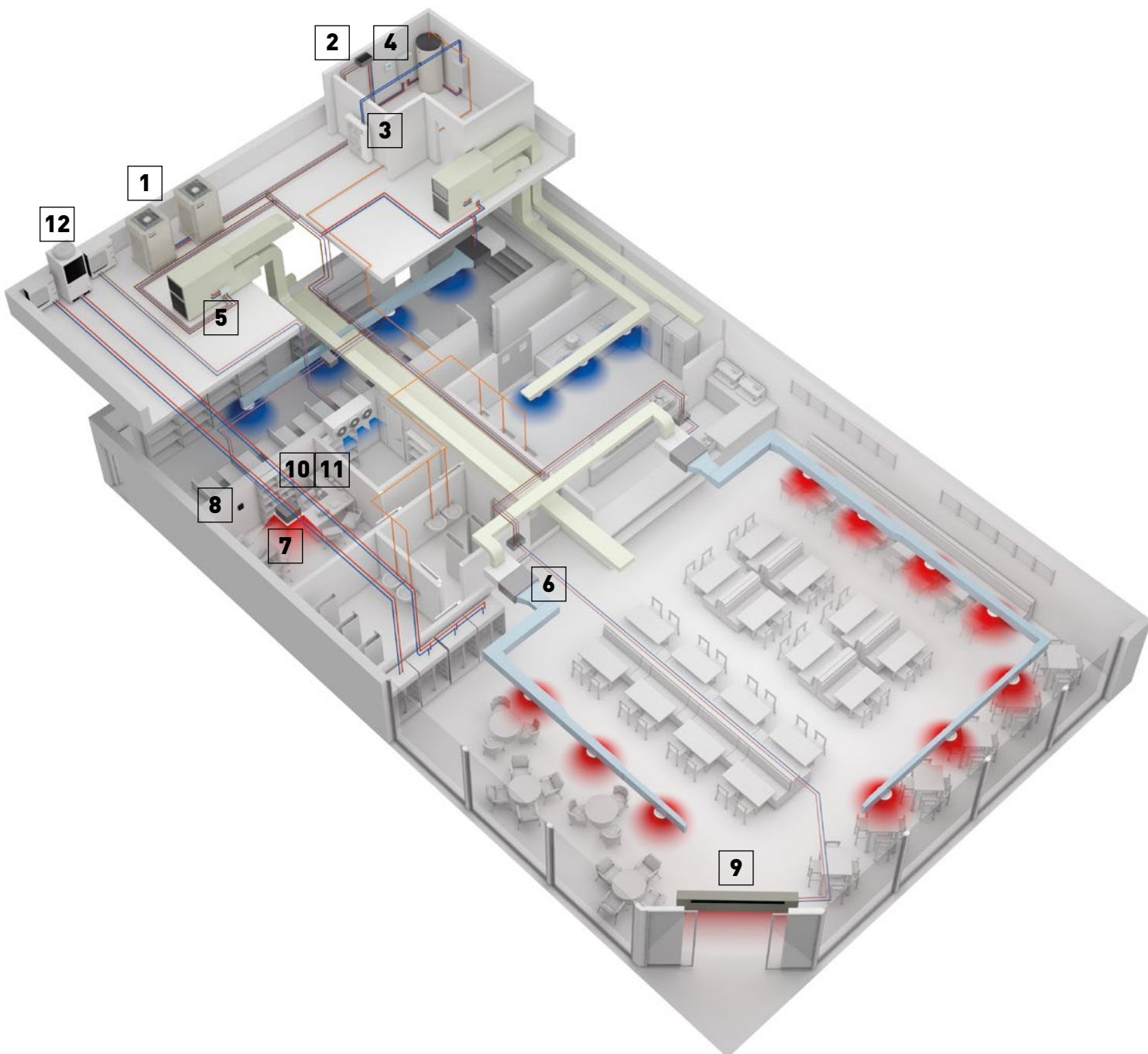

Your entire hotel with superior comfort, control and savings too



1a Hybrid system.
Gas + Electricity Hybrid system. Taking advantage of Gas and Electricity to achieve the most efficient performance and maximum energy saving, whilst reducing reliance on the electricity grid.



1b Gas VRF. ECO G.
ECO G gas VRF is designed for buildings where the electricity is restricted or CO₂ emissions must be reduced. Sanitary hot water is produced for free, all year round.



2 Hydronic units.
Providing hot and cold water for heating and refrigeration (Aquarea Air radiators, underfloor heating, radiators...).

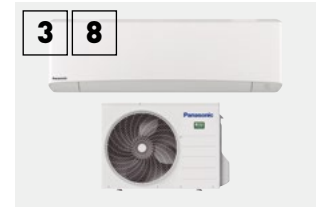

3 8 YKEA unit for server room.
Steady cooling, nonstop, even at -25 °C and still with high efficiency. Ready for continuous operation and easy to connect 2 systems to automatically alternate and ensure server rooms are kept cool.



4 Air handling unit kits for efficient ventilation.
The AHU connection kit is specially designed to improve the efficiency of the pre-heating or pre-cooling ventilation process.



5 PRO-HT Tank DHW.
DHW tank with maximum outlet temperature 65 °C. Ideal solution for high demand hot water such as shower, spa, or swimming pool.



6 Electric VRF. ECOi EX.
ECOi electrical VRF is specifically designed for the most demanding hotels. High efficiency system. Extended operating range to provide heating at outdoor temperature as low as -25 °C (2-Pipe ECOi EX). Suitable for refurbishment projects.



7 Control your way.
Wide variety of controls, from simple user control to full system control via remote access functionality. Touch panel, web server, consumption control, smartphone control... everything is possible.



9 Wide range of indoor units.
All units provided with supply air temperature sensor and low operation sound level to guarantee maximum guest comfort. Units equipped with nanoe™ X (available in specific models) provide better air quality in public spaces in the hotel.



10 Panasonic AC Smart Cloud / Service Cloud.
Taking your business under control. The Service function makes maintenance work simpler.



11 Protocol friendly.
Great flexibility for integration into your KNX / Modbus / LonWorks / BACnet projects allows fully bi-directional monitoring and control of all the functioning parameters.



12 Air curtain with DX coil.
The Panasonic range of air curtains is designed for smooth operation and efficient performance.

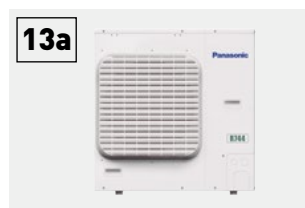

13a Condensing unit with natural refrigerant.
Panasonic CO₂ unit is the natural choice for an energy saving and environmentally friendly solution.



13b PACi NX Elite Series for cooling rooms.
High quality and efficient solution for high temperature refrigeration applications.



14 Maximum savings on hot water production.
Hot water for swimming pool, spa and laundry for free thanks to the residual heat generated by the ECO G units.

Panasonic offers the widest range in HVAC, DHW and ventilation available. That enables us to offer the most suitable solution 24 hours a day, 365 days a year. Panasonic Solutions ensure not only a higher customer satisfaction but also a lower energy bill.

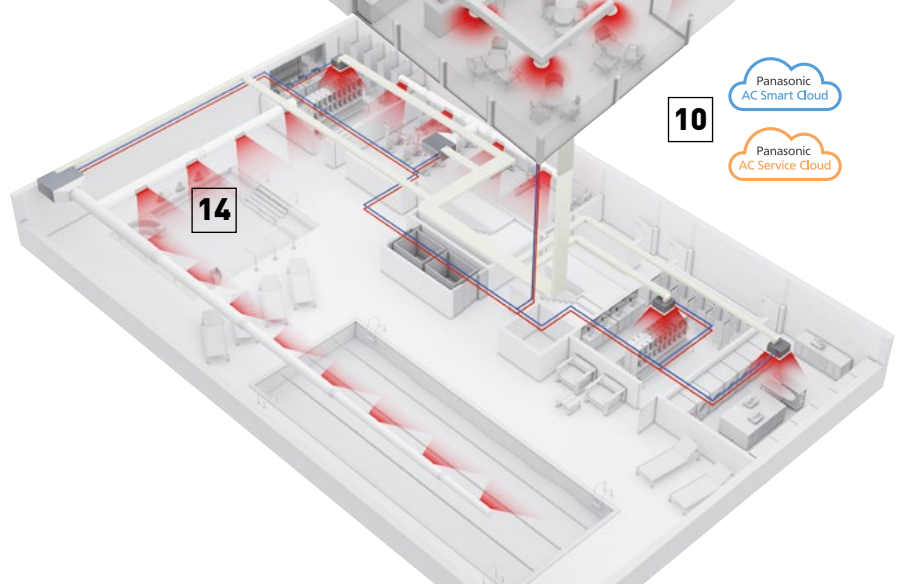
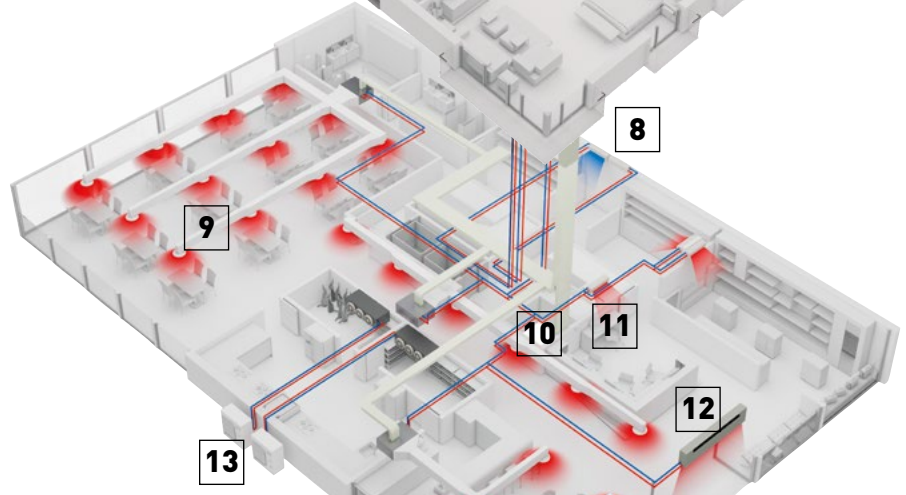
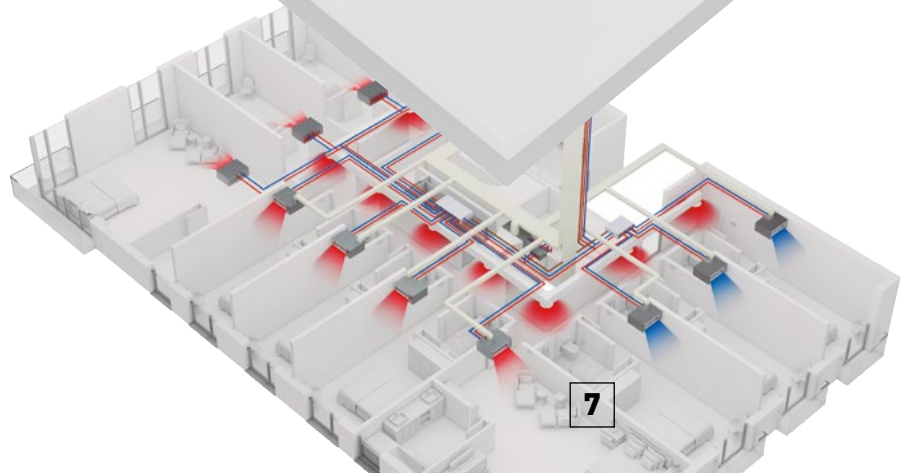
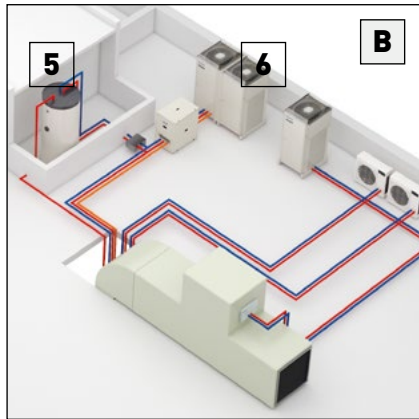
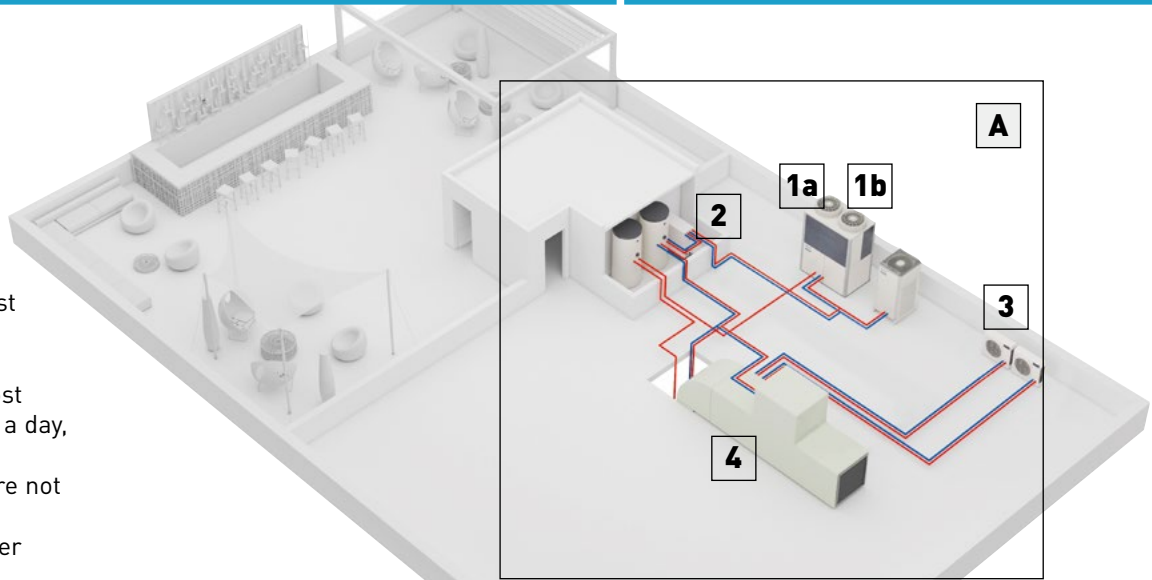

A

Option A: Hybrid solution. Gas + electric:
When large quantities of hot/cold water is needed.

- ECO G (gas heat pump)
- Water heat exchanger
- Aquarea HT to produce hot water up to 65 °C
- Air handling unit kit to connect the ECO G to the AHU
- YKEA wall-mounted to cool the server rooms efficiently

B

Option B: Full Electric solution 2 and 3-Pipe.
When flexibility is needed and electricity power availability is not an issue.

- ECOi (electric VRF)
- Direct expansion indoor units
- Air handling unit (AHU) kit to connect the ECOi to the AHU
- YKEA wall-mounted to cool the server rooms efficiently
- Panasonic Pump Down system

Innovative solutions for retail

Heating and cooling solutions for retail applications

Panasonic has developed solutions for retail and office applications where return on investment is a key factor! The comfort inside the shop is key for a good customer experience. From local control or Panasonic's cloud control system, a detailed status of the heating and cooling system can be displayed, analysed and optimised in order to improve the efficiency, reduce the running time and increase the life time of the units.

8 reason why Panasonic is the best solution for your retail:

- Complete solution
- Flexibility and adaptability
- Go green retail: low CO₂ emissions
- Comfort - high customer satisfaction
- Future expansion
- Panasonic offers efficient systems meeting expectations over the life-span of the project
- High quality of service with Panasonic pro-partner installation team
- The system will still operate down to 25% of the connected indoor units. System will not stop when only 25% of indoor units have power supply breakdown when they are on mode

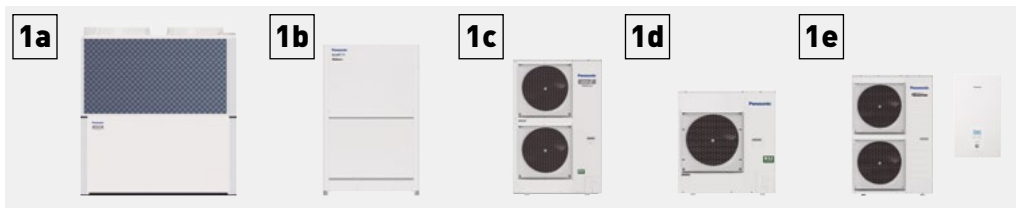

Multi energy solutions, gas or electric.

The Multi energy solution (Gas and Electric) from Panasonic provides the best choice in energy saving and on the flexibility of the installation. Panasonic solutions can be connected to direct expansion systems, water chiller installations and ventilation systems as air handling units.

- 1a: Gas VRF. ECO G
 1b: Electric VRF. ECOi
 1c: Electric VRF. Mini ECOi
 1d: Electric 1x1. PACi NX
 1e: Electric A2W. Aquarea



YKEA unit for server room.

Steady cooling, nonstop, even at -25 °C and still with high efficiency. Ready for continuous operation and easy to connect 2 systems to automatically alternate and ensure server rooms are kept cool.



Control your way.

Wide variety of controls, from simple user control to full system control via remote access functionality. Touch panel and consumption control.



Econavi Sensor.

The Econavi Sensor detects presence in the room, and quietly adapts the PACi or VRF air conditioning system in order to improve comfort and energy savings.



Wide range of indoor units.

All units provided with supply air temperature sensor and low operation sound level to guarantee maximum guest comfort. Units equipped with nanoE™ X (available in specific models) provide better air quality in public spaces in the hotel.



Hide-away, for power and efficiency.

Super silent units deliver the ideal air supply. Units available from 1,5 kW providing precise temperature control even in small rooms. Two models available: slim unit for height restricted areas (MM type with only 200 mm height and MF type).



Air curtain with DX coil.

The Panasonic range of air curtains is designed for smooth operation and efficient performance.



Protocol friendly.

Great flexibility for integration into your KNX / Modbus / LonWorks / BACnet projects allows fully bi-directional monitoring and control of all the functioning parameters. Range of solutions to control locally or remotely the full system in bi-directional mode.



Air handling unit kits for efficient ventilation.

The AHU connection kit is specially designed to improve the efficiency of the pre-heating or pre-cooling process of the ventilation.

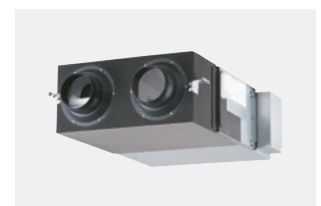





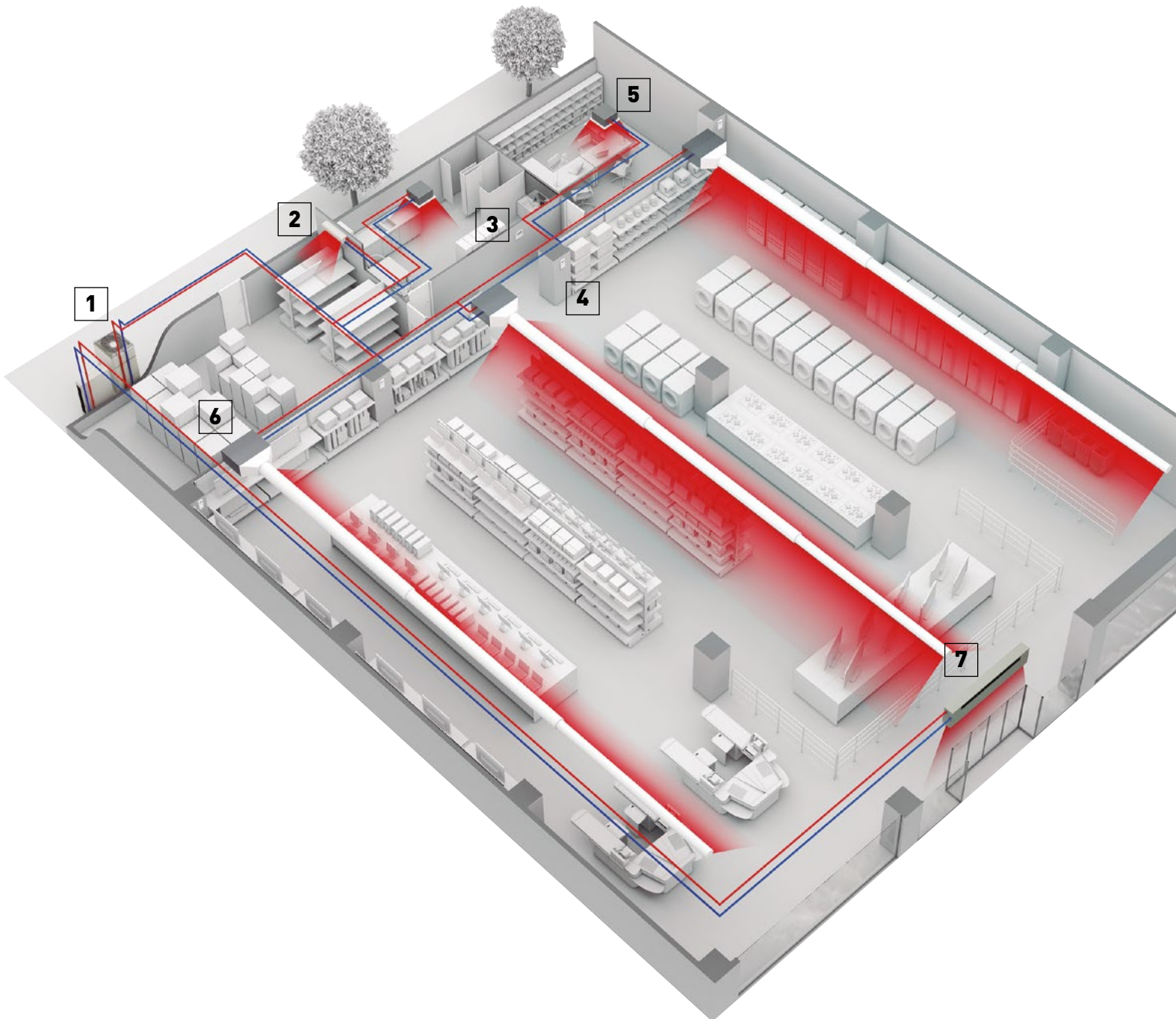











Energy Recovery unit for high efficiency of the system.

Panasonic Energy Recovery Ventilators can reduce the outside air load because they efficiently recover the heat lost by ventilation during the heat recovery process.



VRF outdoor units range

Page	Outdoor units	4 HP	5 HP	6 HP	8 HP	10 HP	12 HP
P. 244	 Mini ECOi LZ2 Series · R32						
		U-4LZ2E5 / U-4LZ2E8	U-5LZ2E5 / U-5LZ2E8	U-6LZ2E5 / U-6LZ2E8	U-8LZ2E8	U-10LZ2E8	
P. 250	Mini ECOi LE2 / LE1 Series · R410A						
		U-4LE2E5 / U-4LE2E8	U-5LE2E5 / U-5LE2E8	U-6LE2E5 / U-6LE2E8	U-8LE1E8	U-10LE1E8	
P. 262	2-Pipe ECOi EX ME2 Series · R410A						
					U-8ME2E8	U-10ME2E8	U-12ME2E8
P. 272	3-Pipe ECOi EX MF3 Series · R410A						
					U-8MF3E8	U-10MF3E8	U-12MF3E8
P. 284	2-Pipe ECO G GE3 Series · R410A						
P. 288	3-Pipe ECO G GF3 Series · R410A						
P. 290	GHP/EHP Hybrid System · R410A						

14 HP

16 HP

18 HP

20 HP

25 HP

30 HP



U-14ME2E8



U-16ME2E8



U-18ME2E8



U-20ME2E8



U-14MF3E8



U-16MF3E8



U-16GE3E5



U-20GE3E5



U-25GE3E5



U-30GE3E5



U-16GF3E5



U-20GF3E5



U-25GF3E5



U-20GES3E5 / U-10MES2E8

Best efficiency ECOi Series from Panasonic

ECOi

The ECOi Series is designed for energy savings, easy installation, and high efficiency. Always continuing to evolve, Panasonic uses advanced technologies to meet the requirements of diverse situations and contribute to the creation of comfortable living spaces.



High performance of
Panasonic's ECOi Series is
verified by Eurovent now*!

* Detailed data in page 278.

Mini ECOi LZ2 Series · R32.

The Mini ECOi LZ2 Series utilizes environmentally friendly R32 refrigerant, reducing the total amount of refrigerant by 20% and more, resulting in lower GWP, reduced by 75%*.

* As a result of applying R32 while at the same time reducing the total refrigerant amount.



Mini ECOi LE Series · R410A.

The 2-Pipe heat pump small VRF system specifically designed for the European market.



2-Pipe ECOi EX ME2 Series · R410A.

The VRF system delivering energy-saving performance, powerful operation, reliability and comfort surpassing anything previously possible.



3-Pipe ECOi EX MF3 Series · R410A.

The VRF system that offers high-efficiency and performance for simultaneous heating and cooling.



Lower running and life cycle costs.

Panasonic ECOi systems are highly efficient VRF systems, offering COPs in excess of 4,0 at full load conditions. The system is also designed to make sure that we reduce the running cost of each system by using our unique road map control routine to ensure that the efficient combination of compressors are running at any one time. Improved defrost sequencing also reduces running costs by defrosting each outdoor coil in turn when conditions allow. Up to 64 indoor units can be connected with a capacity ratio of up to 200% indexed indoor unit loads, enabling the system to be used effectively on highly diversified building loads: this large connectability feature makes it an easy-

to-design solution for schools, hotels, hospitals and other large buildings. Up to 1000 m in pipe length enables the VRF ECOi Series to be used in very large buildings, with maximum design flexibility. The ECOi system is also easy to control. It has more than 8 types of control from standard wired remote controls to touch screen panels or web access interfaces.

DC-Inverter control technology for rapid and powerful cooling and heating. The ever-evolving Panasonic ECOi Series.

ECOi Series benefits.

Ease of installation.

R410A with its higher operating pressure and lower pressure loss allows for smaller pipe sizes to be used with reduced refrigerant charge.

Simple to design.

Panasonic recognise that designing, selecting and preparing a professional VRF quotation can be a time consuming and costly process, especially as it is often also a speculative exercise. So we have designed proprietary software which is quick and easy to use and produces a full schematic layout of pipework and controls, as well as a full materials list with supporting performance data.

Easy to control.

A wide variety of control options are available to ensure that the ECOi system provides the user with the degree of control that they desire, from simple room controllers through to state of the art BMS controls.

Simple to commission.

Simple set-up procedure including automatic addressing of connected indoor units. Configuration settings can be made from an outdoor unit or via a remote controller.

Easy to position.

The compact design of the ECOi outdoor units means that sizes 4 HP to 10 HP fit into a standard lift and are easy to handle and position when on site. The small footprint and modular appearance of the units ensure a cohesive appearance to an installation.

Wide selection and connectability.

With 17 indoor model styles available, ECOi systems are the ideal choice for multiple small capacity indoor unit installations, with the ability to connect up to 40 indoor units to systems of 24 HP or greater for 3-Pipe ECOi EX MF3 Series.

Easy to maintain.

Each system allows the use of prognostic and diagnostic controls routines, to manage system operation and identifying faults, all designed to reduce the speed of maintenance calls and unit down time.

Mini ECOi LZ2 Series R32

ECO i

Outstanding efficiency in a compact body and continuous operation even at extreme ambient temperatures.



Industry 1st 8 HP and 10 HP
Mini VRF units with R32



4 / 5 / 6 HP



8 / 10 HP



1 Low GWP and less refrigerant

The Mini ECOi LZ2 Series utilizes environmentally friendly R32 refrigerant, reducing the total amount of refrigerant by 20% and more, resulting in lower GWP, reduced by 75%*.

* As a result of applying R32 while at the same time reducing the total refrigerant amount.

2 Outstanding efficiency at the most challenging ambient conditions

Re-engineered for better performance, the LZ2 series produces extraordinary savings with SEER levels up to 8,5 and SCOP levels up to 5,0 (for 4 HP model). The large range of outdoor units from 12 kW to 28 kW can also work at extreme ambient temperatures, down to -20 °C in heating and up to 52 °C in cooling, providing a very wide range of operating ability.

3 More flexibility for your project

The ECOi LZ2 series provides ease of installation with long piping lengths and small footprints in a lightweight body. A variety of indoor units, supporting Panasonic's optional R32 refrigerant leak detector, increases the flexibility for installers. A wide range of individual and central controllers, AC Smart Cloud and Service Cloud, as well as apps for end users and installers, provide a fully customizable monitoring and controlling solution.

Minimum environmental impact.

Panasonic has designed the LZ2 series in order to minimize the environmental impact of the system. Low GWP refrigerant R32 and highest efficiency levels ensure this through the total operational lifetime.



VRF with outstanding energy-saving performance and superior SEER and SCOP

Mini ECOi LZ2 provides the optimal performance in any climatic condition.

Wide operating range
-20 °C in heating to
52 °C in cooling

8,5 SEER | 5,0 SCOP
Extraordinary savings

ECOi LZ2 mini VRF series from 12 to 28 kW

- Improving protection 24/7. Unique indoors with nanoe™ X, hydroxyl radicals contained in water
- SEER levels up to 8,5 and SCOP levels up to 5,0 (for 4 HP model)
- Low GWP and highly reduced refrigerant volume
- Improved connectivity with CONEX remote controllers and app support, Smart and Service Cloud applications and support for communication protocols for BMS integration
- Wide range of connectable units allowing wide range of installations with and without refrigerant mitigation
- Increased indoor / outdoor capacity ratio up to 150%
- Quiet mode operation with low capacity drop
- Same Panasonic DNA with Panasonic compressors and precise temperature control thanks to discharge temperature sensors in the indoor units
- Continuous operation at extreme ambient temperatures: -20 °C (heating) to 52 °C (cooling)
- Flexible mitigation measures, with Panasonic R32 refrigerant leak detector / alarm to be installed only when required
- 35 Pa static pressure

For the most challenging spaces

The Mini ECOi LZ2 R32 VRF system is the ideal solution to fit into any application thanks to its compact design and long piping length support.

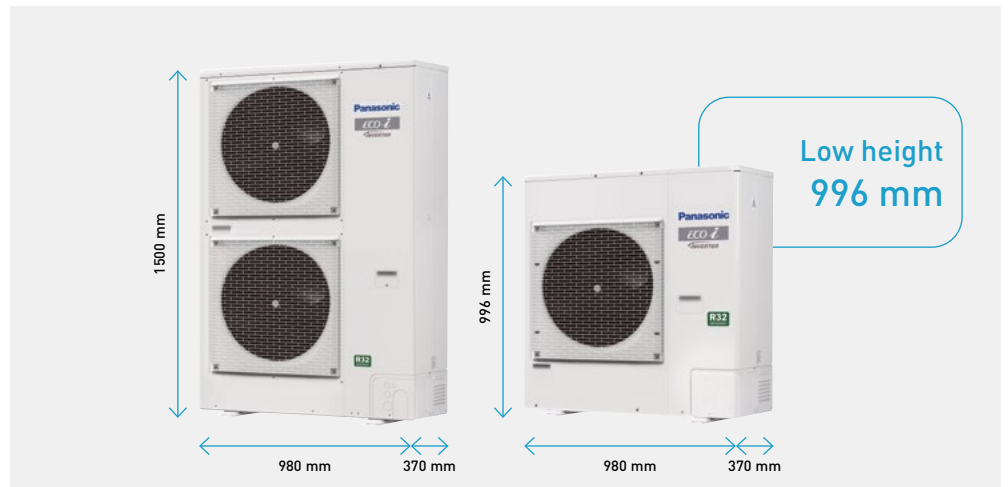

Extended design operation conditions

LZ2 mini VRF is extremely reliable even under the most difficult conditions. The units can operate in cooling mode at extreme temperatures, 52 °C in cooling and -20 °C in heating mode.

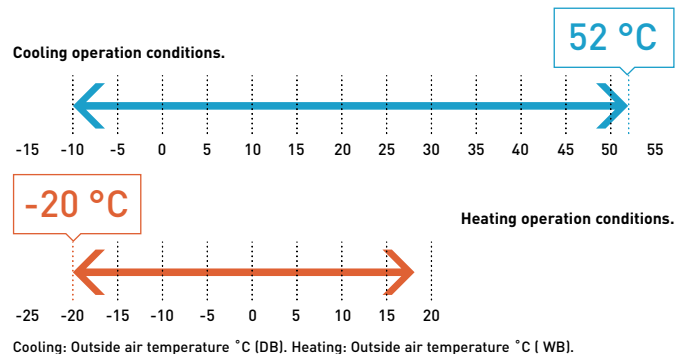
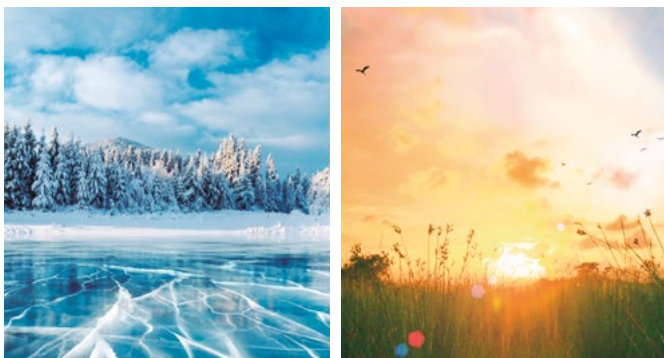











Compatible with a large range of indoor units and controls

An expansion of Panasonic VRF line up, the Mini ECOi R32 is compatible with a large range of indoor units and can utilize all Panasonic's scalable control and monitoring solutions.

Wide range of indoor units, either supporting Panasonic's optional R32 refrigerant leak detector alarm or having built-in detectors provide a great flexibility for all types of installation.

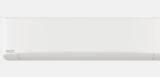
Scaling your control options from a single zone to geographically distributed facilities.

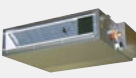
LZ2 series are fully compatible with all control and connectivity solutions from Panasonic. With a wide range of individual controllers, hotel room controllers, optional wireless adapters, VRF Smart Connectivity+, easy BMS connection with S-Link and Panasonic AC Smart Cloud compatibility. LZ2 series, the most flexible control and monitoring R32 solution in the market.

	4 way 90x90 cassette		Connects Panasonic R32 sensor
	4 way 60x60 cassette		Connects Panasonic R32 sensor
	Variable static pressure adaptive duct		Built-in R32 sensors
	Wall-mounted		Connects Panasonic R32 sensor
	Slim variable static pressure hide-away		Connects Panasonic R32 sensor

Panasonic R32 refrigerant leak detector/alarm (optional)

For compatible indoor unit models, Panasonic offers its optional external Panasonic R32 refrigerant leak detector (CZ-CGLSC1). This enables the customer to decide if a Panasonic R32 refrigerant leak detector is required to comply with the restrictions, or if the indoor unit may be safely installed in this room without it. This optional leakage detection sensor has an integrated alarm buzzer and can output a signal to a central alarm system in the building. The device is connected to the remote control terminals of the indoor unit and can be used in combination with any of the Panasonic VRF remote controllers, either wired or wireless.

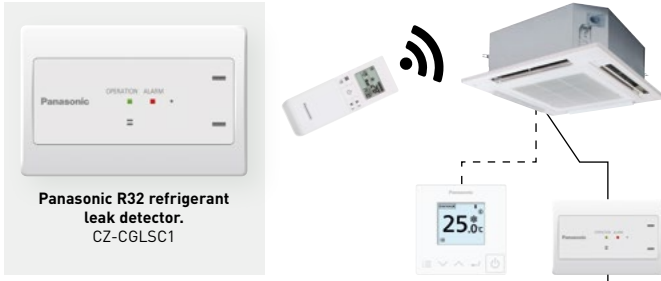

Panasonic R32 refrigerant leak detector. CZ-CGLSC1

The alarm triggered by the Panasonic R32 refrigerant leak detector will also be transmitted and displayed on any connected centralised controller.

* Only one remote controller can be connected with the Panasonic R32 refrigerant leak detector.

5 V external output (central monitoring etc.)

R32 Pump Down solution

R32 Pump Down solution offers the assurance of additional safety protection, whilst expanding the potential installation cases, allowing for installation within smaller rooms.

Suitable for the Mini ECOi LZ2 range up to 10 HP, compatible indoor units connected to CZ-CGLSC1 or integrated Panasonic R32 refrigerant leak detector.

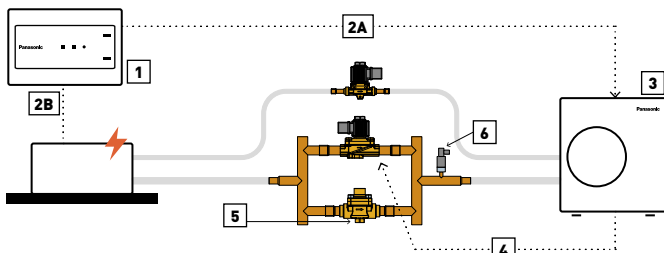

Operation steps: 1 | A leak is detected by the leak detection sensor. 2A | Leak alarm signal is sent to the outdoor unit. 2B | Indoor unit fan activated and runs at maximum speed. 3 | Pump Down procedure is activated. 4 | Solenoid valves are closed preventing refrigerant returning to indoor units. 5 | Outdoor unit is operating in Pump Down mode and check valve only allows flow to the outdoor unit. 6 | Low pressure switch threshold is reached. Error signal isolates the outdoor unit, preventing restart.

Technical focus

- Simplified design and installation
- Complies with IEC 60335-2-40 ed.6.0
- Recovers base charge within outdoor unit
- Expands potential installation cases
- IP rated connections for outdoor installation

Model reference	Description
PAW-PUD2WB-1	Basic Pump Down system (2 way) for one R32 Mini ECOi outdoor unit

Pump Down kit.
Indication of the items included within the Pump Down kit.

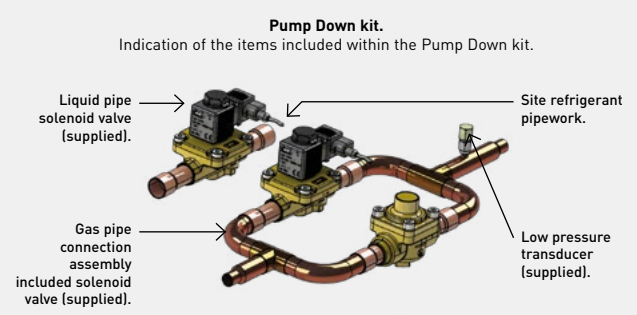

- Liquid pipe solenoid valve (supplied).
- Gas pipe connection assembly included solenoid valve (supplied).
- Site refrigerant pipework.
- Low pressure transducer (supplied).

Mini ECOi LZ2 Series 4 to 6 HP · R32

Outstanding efficiency in a compact body and continuous operation even at extreme ambient temperatures.

- SEER levels up to 8,5 and SCOP levels up to 5,0 (for 4 HP model)
- Continuous operation at extreme ambient temperatures: -20 °C (heating) to 52 °C (cooling)
- Wide range of connectable units
- Unique indoors with nanoe™ X, hydroxyl radicals contained in water
- Allowing wide range of installations with and without mitigation measures
- Flexible mitigation measures, with Panasonic R32 refrigerant leak detector / alarm to be installed only when required

Low height
996 mm



HP			4 HP	5 HP	6 HP	4 HP	5 HP	6 HP
Outdoor unit			U-4LZ2E5	U-5LZ2E5	U-6LZ2E5	U-4LZ2E8	U-5LZ2E8	U-6LZ2E8
Power supply	Voltage	V	220 - 230 - 240	220 - 230 - 240	220 - 230 - 240	380 - 400 - 415	380 - 400 - 415	380 - 400 - 415
	Phase		Single phase	Single phase	Single phase	Three phase	Three phase	Three phase
	Frequency	Hz	50	50	50	50	50	50
Cooling capacity		kW	12,1	14,0	15,5	12,1	14,0	15,5
EER ¹⁾		W/W	4,53	4,12	3,88	4,53	4,12	3,88
Current		A	13,30 - 12,80 - 12,20	16,90 - 16,20 - 15,50	19,60 - 18,70 - 18,00	4,37 - 4,15 - 4,00	5,50 - 5,23 - 5,04	6,44 - 6,12 - 5,89
Input power		kW	2,67	3,40	4,00	2,67	3,40	4,00
Heating capacity		kW	12,5	16,0	16,5	12,5	16,0	16,5
COP ¹⁾		W/W	5,27	4,71	4,42	5,27	4,71	4,42
Current		A	12,00 - 11,40 - 11,00	16,90 - 16,20 - 15,50	18,50 - 17,70 - 17,00	3,91 - 3,71 - 3,58	5,50 - 5,22 - 5,03	6,02 - 5,72 - 5,51
Input power		kW	2,37	3,40	3,73	2,37	3,40	3,73
Starting current		A	1,0	1,0	1,0	1,0	1,0	1,0
Maximum current		A	19,6	23,7	26,5	7,2	9,2	9,9
Maximum input power		kW	3,92 - 4,10 - 4,28	4,76 - 4,98 - 5,19	5,41 - 5,66 - 5,90	4,40 - 4,63 - 4,80	5,69 - 5,99 - 6,22	6,15 - 6,47 - 6,72
Maximum number of connectable indoor units ²⁾			7(10)	8(12)	9(12)	7(10)	8(12)	9(12)
External static pressure		Pa	0 - 35	0 - 35	0 - 35	0 - 35	0 - 35	0 - 35
Air flow		m ³ /min	69	72	74	69	72	74
Sound pressure	Cool	dB(A)	52	53	54	52	53	54
	Cool (Silent 1/2/3/4)	dB(A)	49/47/45/45	50/48/46/45	51/49/47/45	49/47/45/45	50/48/46/45	51/49/47/45
	Heat	dB(A)	54	56	56	54	56	56
Sound power	Cool / Heat	dB(A)	69/72	70/74	72/75	69/72	70/74	72/75
Dimension	H x W x D	mm	996 x 980 x 370	996 x 980 x 370	996 x 980 x 370	996 x 980 x 370	996 x 980 x 370	996 x 980 x 370
Net weight		kg	94	94	94	94	94	94
Piping diameter	Liquid	Inch (mm)	3/8(9,52)	3/8(9,52)	3/8(9,52)	3/8(9,52)	3/8(9,52)	3/8(9,52)
	Gas	Inch (mm)	5/8(15,88)	5/8(15,88)	5/8(15,88)	5/8(15,88)	5/8(15,88)	5/8(15,88)
Maximum piping length (total)		m	90(180)	90(180)	90(180)	90(180)	90(180)	90(180)
Elevation difference (in / out)		m	50(OU above)/ 40(OU below)	50(OU above)/ 40(OU below)	50(OU above)/ 40(OU below)	50(OU above)/ 40(OU below)	50(OU above)/ 40(OU below)	50(OU above)/ 40(OU below)
Refrigerant (R32)		kg	2,7	2,7	2,7	2,7	2,7	2,7
Maximum allowable indoor / outdoor capacity ratio ³⁾		%	50 - 150(130)	50 - 150(130)	50 - 150(130)	50 - 150(130)	50 - 150(130)	50 - 150(130)
Operating range	Cool Min - Max	°C	-10 - 52	-10 - 52	-10 - 52	-10 - 52	-10 - 52	-10 - 52
	Heat Min - Max	°C	-20 - 18	-20 - 18	-20 - 18	-20 - 18	-20 - 18	-20 - 18

ErP data ⁴⁾								
SEER ⁵⁾			8,50	8,12	7,71	8,50	8,12	7,71
$\eta_{s,c}$			337,0%	321,8%	305,4%	337,0%	321,8%	305,4%
SCOP ⁵⁾			5,05	4,61	4,59	5,05	4,61	4,59
$\eta_{s,h}$			199,0%	181,4%	180,6%	199,0%	181,4%	180,6%

1) EER and COP calculation is based on EN 14511. 2) The number in parenthesis indicates maximum number of connectable indoor unit in case of 1,5 kW indoor units connection. 3) The number in parenthesis indicates maximum allowed indoor / outdoor capacity ratio in case of 1,5 kW indoor units connection. 4) SEER / SCOP and $\eta_{s,c}$ / $\eta_{s,h}$ are in accordance with ErP test data for U2 type 4 way 90x90 cassette indoor units. Eurovent certified. 5) SEER / SCOP is calculated based on the seasonal space cooling / heating efficiency " η " values of the COMMISSION REGULATION (EU) 2016/2281. SEER, SCOP = (η + Correction) × PEF.

Minimum environmental impact

Panasonic has designed the LZ2 series in order to minimize the environmental impact of the system. Low GWP refrigerant R32 and highest efficiency levels ensure this through the total operational lifetime.

For the most challenging spaces

The Mini ECOi LZ2 R32 VRF system is the ideal solution to fit into any application thanks to its compact design and long piping lengths.



INTERNET CONTROL: Optional.

Mini ECOi LZ2 Series 8 and 10 HP · R32

Introducing widest range of R32 Mini VRF.

- SEER levels up to 7,6 and SCOP levels up to 4,6 (for 8 HP model)
- Continuous operation at extreme ambient temperatures: -20 °C (heating) to 52 °C (cooling)
- Widest range of connectable units in R32 VRF
- Unique indoors with nanoe™ X, hydroxyl radicals contained in water
- Allowing wide range of installations with and without refrigerant mitigation
- Flexible mitigation measures, with Panasonic R32 refrigerant leak detector / alarm to be installed only when required

Industry 1st
8 HP and 10 HP
Mini VRF units
with R32

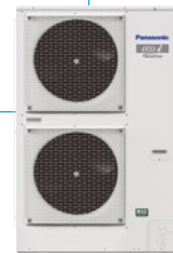

HP			8 HP	10 HP
Outdoor unit			U-8LZ2E8	U-10LZ2E8
Power supply	Voltage	V	380-400-415	380-400-415
	Phase		Three phase	Three phase
	Frequency	Hz	50	50
Cooling capacity		kW	22,4	28,0
EER ¹⁾		W/W	3,84	3,47
Current		A	9,73 - 9,25 - 8,91	13,2 - 12,5 - 12,1
Input power		kW	5,83	8,07
Heating capacity		kW	25,0	28,0
COP ¹⁾		W/W	4,30	4,47
Current		A	9,81 - 9,32 - 8,98	10,5 - 9,93 - 9,57
Input power		kW	5,81	6,26
Starting current		A	1,0	1,0
Maximum current		A	13,7	19,5
Maximum input power		kW	8,21 - 8,64 - 8,96	11,9 - 12,6 - 13,0
Maximum number of connectable indoor units ²⁾			16	16
External static pressure		Pa	0 - 35	0 - 35
Air flow		m ³ /min	158	167
Sound pressure	Cool	dB(A)	59,0	60,0
	Cool (Silent 1/2/3/4)	dB(A)	56/54/52/50	57/55/53/50
Sound power	Cool	dB(A)	72	74
Dimension	H x W x D	mm	1500 x 980 x 370	1500 x 980 x 370
Net weight		kg	125	126
Piping diameter	Liquid	Inch (mm)	3/8(9,52)	3/8(9,52)
	Gas	Inch (mm)	3/4(19,05)	7/8(22,22)
Maximum piping length (total)		m	100(300)	100(300)
Elevation difference (in / out)		m	50(OU above)/40(OU below)	50(OU above)/40(OU below)
Refrigerant (R32)		kg	4,9	5,1
Maximum allowable indoor / outdoor capacity ratio ³⁾		%	50 - 150(130)	50 - 150(130)
Operating range	Cool Min ~ Max	°C	-10 - 52	-10 - 52
	Heat Min ~ Max	°C	-20 ~ 18	-20 ~ 18

ErP data⁴⁾

SEER ⁵⁾	7,56	7,08
$\eta_{s,c}$	299,4%	280,2%
SCOP ⁵⁾	4,59	4,60
$\eta_{s,h}$	180,6%	181,0%

1) EER and COP calculation is based on EN 14511. 2) The number in parenthesis indicates maximum number of connectable indoor unit in case of 1,5 kW indoor units connection. 3) The number in parenthesis indicates maximum allowed indoor / outdoor capacity ratio in case of 1,5 kW indoor units connection. 4) SEER / SCOP and $\eta_{s,c}$ / $\eta_{s,h}$ are in accordance with ErP test data for F2 type variable static pressure hide-away indoor units. Eurovent certified. 5) SEER / SCOP is calculated based on the seasonal space cooling / heating efficiency " η " values of the COMMISSION REGULATION (EU) 2016/2281. SEER, SCOP = (η + Correction) × PEF.

Perfect fit for small to medium size projects

8 and 10 HP LZ2 Mini VRF units bring in the total benefits of a VRF system in a smaller application. You can enjoy advanced individual and central VRF control options including the revolutionary Panasonic AC Smart Cloud and AC Service Cloud.

For the most difficult conditions

The Mini ECOi LZ2 series are able to operate at the hardest conditions from -20 °C up to +52 °C providing continuous and efficient, heating and cooling for your space all year long.



INTERNET CONTROL: Optional.

Rating conditions: Cooling indoor 27 °C DB / 19 °C WB. Cooling outdoor 35 °C DB / 24 °C WB. Heating indoor 20 °C DB. Heating outdoor 7 °C DB / 6 °C WB. (DB: Dry Bulb; WB: Wet Bulb). Specifications subject to change without notice. For detailed information about ErP / Energy Labelling, please visit our websites www.aircon.panasonic.eu or www.ptc.panasonic.eu.

Mini ECOi LE Series for light commercial and residential use

ECOi

Mini ECOi with extraordinary energy-saving performance and high external static pressure (35Pa).

Compact design



7,9
SEER4,9*
SCOPIndustry leading
efficiency

4 / 5 / 6 HP

6,4*
SEER4,3
SCOP

8 / 10 HP

1 Efficiency energy control

Upgraded outdoor units deliver high efficiency rating and reduced energy costs.

2 Space saving

Ideal for commercial locations with limited space such as banks and shops. Compact units integrate easily and discreetly into building design.

3 Flexible installation

Reduced installation time thanks to compact units and extra long piping without additional refrigeration charge. High external static pressure 35 Pa and small chassis increase installation options.

Compact design: LE2 Series - 4 / 5 / 6 HP

- Extraordinary energy saving: 7,9 SEER and 4,9 SCOP (4 HP)*
- 50 m piping length without additional refrigerant charge
- Quiet operation mode with 4 levels
- High COP mode option

* SEER / SCOP is calculated based on the seasonal space cooling / heating efficiency "η" values of the COMMISSION REGULATION (EU) 2016/2281. SEER, SCOP = (η + Correction) × PEF.

LE1 Series - 8 / 10 HP

- 60% smaller than ECOi ME2 8 / 10 HP vertical flow type
- Flexible piping length (Total: 300 m, Furthest: 150 m)
- Maximum number of connectable indoor units: 15

Key features for LE2 / LE1.

- High external static pressure 35 Pa
- Full range of ECOi indoor units and controllers
- Variable evaporation temperature control as standard
- Connectable maximum indoor / outdoor capacity ratio up to 130%
- Auto restart from outdoor units
- Demand response (Peak cut) by optional parts
- Suitable for R22 renewable projects



Flexible, easy and hassle free installation

Compact space-saving design. High external static pressure 35 Pa. Long piping length for flexible installation. No additional refrigerant charge up to 50 m. 130% capacity ratio for connectable indoor units.

High external static pressure 35 Pa

- High air pressure
- An efficient blade design
- Perfect for high class condominiums

When unit is installed on a narrow balcony and exposed to the sun, the barrier at the front side may restrict hot air from being discharged. Heat accumulated in an enclosure can cause over-heating. This may potentially result in damage or shorten the product's life span. A high external static pressure fan sends the air further away from the outdoor unit and through the barrier. This provides better air circulation and distribution.

And a high air pressure of 35 Pa discharges the hot air to a sufficient distance.

Previous model - low pressure.

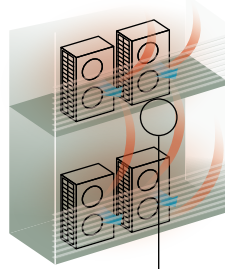

Heat accumulated.
When the pressure is low, hot air will accumulate in the unit thus affecting its work performance and that of unit above it as well.



Previous fan

LE Series - high pressure.

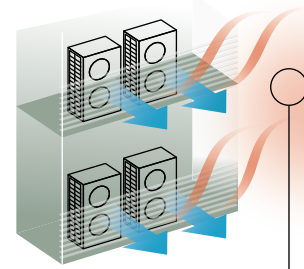

Heat discharged.
But with a high pressure of 35 Pa, hot air is sent further away preventing overheating inside the outdoor unit enclosure.



LE2's fan

Long piping design length for greater design flexibility

- LE1: Maximum total piping length: 300 m.
- LE2: Maximum total piping length: 180 m.

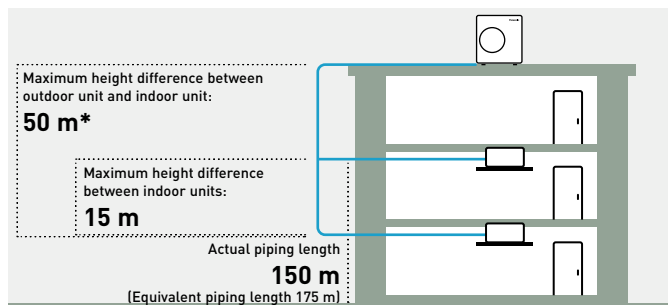

* 40 m if the outdoor unit is below the indoor unit.

Plug & Play concept

- 50 m piping length free of charge
- A 50 m pipe length is sufficient for most residential and small business buildings

Free of charge
50 m

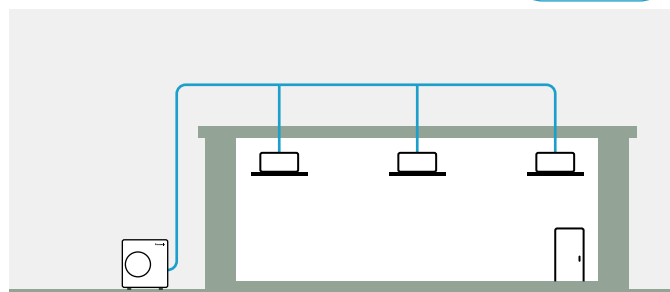

Connection of up to 15 indoor units

An expansion from Panasonic VRF line up, the mini ECOi is compatible with the same indoor units and controls as the rest of the ECOi range.

Compact design

Mini ECOi LE Series is a single unit.

Perfect for installations with limited space and easy to hide within a modern building. Flexible space-saving options compared to single split system.

LE2 low height of 996 mm.

LE2 Series is 25% smaller in height than conventional model.

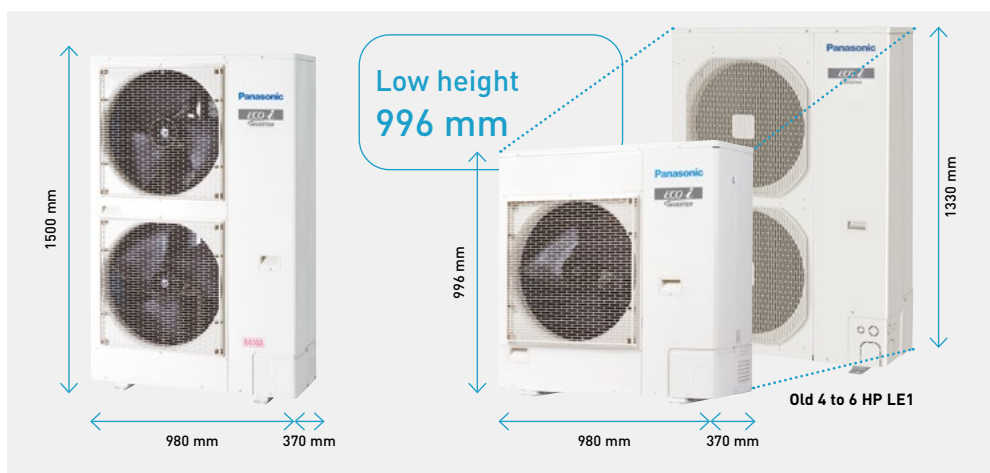

Energy control and reliability

The Mini ECOi system delivering energy-saving performance, powerful operation, reliability and comfort surpassing anything previously possible.

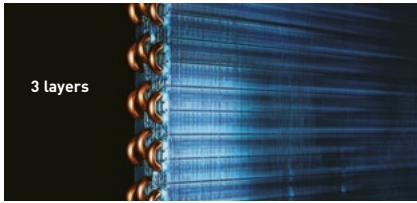

Powerful heat exchanger.
3 layers of heat exchanger for all LE Series. LE Series features the same heat exchange volume as conventional model even though it is 15% smaller in size.

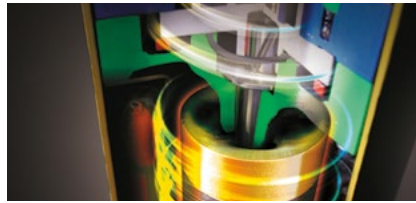

Panasonic twin rotary compressor.
A large capacity Inverter compressor has been adopted. This compressor features wider and 0,1 Hz step Inverter control.



Design fan.
Fan blades have been redesigned to inhibit air resistance and to increase efficiency. The larger fan increases air flow while maintaining low noise levels.

Energy savings design

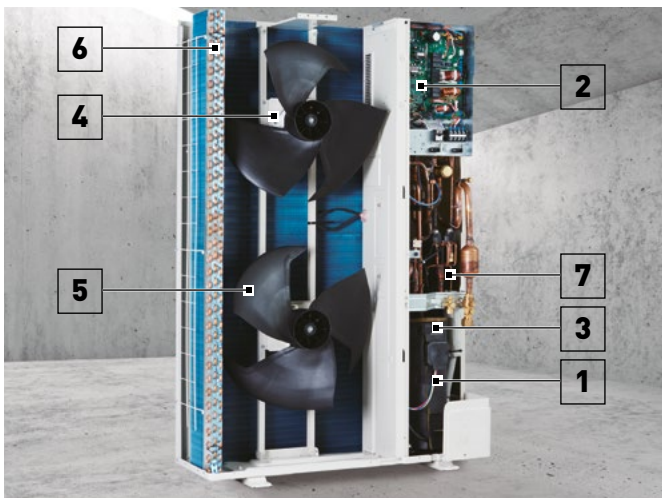

- 1 | **Panasonic Inverter compressor.** A large-capacity Inverter compressor has been adopted. The Inverter compressor is superior in performance with improved partial-load capacity.
- 2 | **Printed circuit board.** Maintenance is made easier with only 2 PCBs.
- 3 | **Accumulator.** A large accumulator has been adopted to maintain compressor reliability because of the increased refrigerant quantity, which allows an extended maximum piping length.
- 4 | **DC fan motor.** Checking load and outside temperature, the DC motor is controlled for optimum air flow.
- 5 | **Blade shape.** The fan blades have been developed to inhibit air turbulence and increase efficiency. As the fan diameter has been increased, air flow has also increased whilst maintaining a same sound level.
- 6 | **Heat exchanger and copper tubes.** The heat exchanger size and the copper tube sizes in the heat exchanger have been redesigned to increase efficiency.
- 7 | **Oil separator.** A centrifugal separator has been adopted to improve oil separation efficiency and reduce refrigerant pressure loss.

Bluefin condenser: high durability outdoor unit

The anti-corrosion Bluefin treatment of the heat exchanger provides greater resistance against corrosion. All models are equipped with Bluefin condenser and corrosion-resistance treated for high resistance to rust and salty air to assure long-lasting performance.

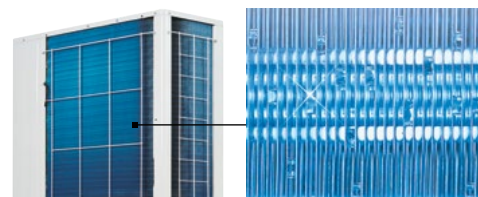

Heat exchanger (Bluefin condenser)

Maximum comfort with quiet operation mode

- Quiet operation mode reduces outdoor unit operating sound by 7 dB(A)
- 4-step set point is available
- Silent mode 1 maintains rated cooling capacity

* Timer setting of quiet operation mode is available in High-spec remote controller.

Silent mode options	Sound pressure level
Silent mode 1	-1,5 dB(A)
Silent mode 2	-3 dB(A)
Silent mode 3	-5 dB(A)
Silent mode 4	-7 dB(A)

SEER / SCOP

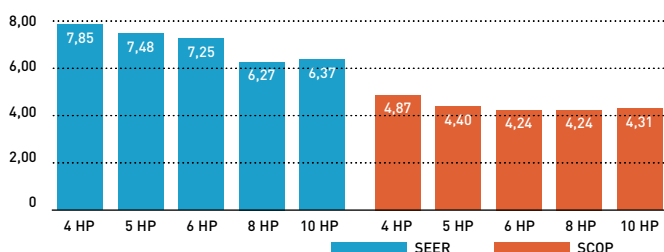

Superior seasonal energy efficiency (SEER / SCOP follows LOT21*)

The operation efficiency has been improved using highly efficient R410A refrigerant, a DC Inverter compressor, DC motor and a heat exchanger design.

* SEER / SCOP is calculated based on the seasonal space cooling / heating efficiency "η" values of the COMMISSION REGULATION (EU) 2016/2281. SEER, SCOP = (η + Correction) × PEF.

Mini ECOi LE2 Series high efficiency 4 to 6 HP · R410A

Panasonic Mini ECOi. Extraordinary energy-saving.

The most compact ECOi system ever.

- Outstanding SEER and SCOP
- Better efficiency even compared to 2 fan outdoor units
- 50 m piping without additional refrigeration charge
- High static pressure 35 Pa
- High COP mode selectable with maintenance remote controller
- Selectable silent mode



HP			4 HP	5 HP	6 HP	4 HP	5 HP	6 HP
Outdoor unit			U-4LE2E5	U-5LE2E5	U-6LE2E5	U-4LE2E8	U-5LE2E8	U-6LE2E8
Power supply	Voltage	V	220-230-240	220-230-240	220-230-240	380-400-415	380-400-415	380-400-415
	Phase		Single phase	Single phase	Single phase	Three phase	Three phase	Three phase
	Frequency	Hz	50	50	50	50	50	50
Cooling capacity		kW	12,1	14,0	15,5	12,1	14,0	15,5
EER ¹⁾		W/W	4,50	4,06	3,73	4,50	4,06	3,73
Current		A	13,30-12,70-12,20	16,30-15,60-17,00	20,30-19,40-18,60	4,39-4,17-4,02	5,58-5,30-5,11	6,71-6,37-6,14
Input power		kW	2,69	3,45	4,15	2,69	3,45	4,15
Heating capacity		kW	12,5	16,0	16,5	12,5	16,0	16,5
COP ¹⁾		W/W	5,19	4,60	4,27	5,19	4,60	4,27
Current		A	12,20-11,60-11,20	17,60-16,80-16,10	19,10-18,20-17,50	3,98-3,78-3,64	5,62-5,34-5,14	6,24-5,93-5,71
Input power		kW	2,41	3,48	3,86	2,41	3,48	3,86
Starting current		A	1,00	1,00	1,00	1,00	1,00	1,00
Maximum current		A	17,30	24,30	27,40	7,90	10,10	10,70
Maximum input power		kW	3,50-3,66-3,82	4,92-5,14-5,37	5,61-5,86-6,12	4,34-5,09-5,28	6,25-6,55-6,82	6,62-6,97-7,23
Maximum number of connectable indoor units ²⁾			7(10)	8(10)	9(12)	7(10)	8(10)	9(12)
External static pressure		Pa	0-35	0-35	0-35	0-35	0-35	0-35
Air flow		m ³ /min	69	72	74	69	72	74
Sound pressure	Cool	dB(A)	52	53	54	52	53	53
	Cool (Silent 1/2/3/4)	dB(A)	50,5/49/47/45	51,5/50/48/46	52,5/51/48/46	50,5/49/49/47	48,5/50/48/46	48,5/50/48/46
	Heat	dB(A)	54	56	56	54	56	56
Sound power	Cool / Heat	dB(A)	69/72	71/75	73/75	69/72	71/75	73/75
Dimension	HxWxD	mm	996x980x370	996x980x370	996x980x370	996x980x370	996x980x370	996x980x370
Net weight		kg	106	106	106	106	106	106
Piping diameter	Liquid	Inch (mm)	3/8(9,52)	3/8(9,52)	3/8(9,52)	3/8(9,52)	3/8(9,52)	3/8(9,52)
	Gas	Inch (mm)	5/8(15,88)	5/8(15,88)	5/8(15,88)	5/8(15,88)	5/8(15,88)	5/8(15,88)
Maximum piping length (total)		m	150(180)	150(180)	150(180)	150(180)	150(180)	150(180)
Elevation difference (in / out)		m	50(OU above)/ 40(OU below)	50(OU above)/ 40(OU below)	50(OU above)/ 40(OU below)	50(OU above)/ 40(OU below)	50(OU above)/ 40(OU below)	50(OU above)/ 40(OU below)
Refrigerant (R410A) / CO ₂ Eq.		kg / T	6,70(14,40)/ 13,9896	6,70(14,40)/ 13,9896	6,70(14,40)/ 13,9896	6,70(14,40)/ 13,9896	6,70(14,40)/ 13,9896	6,70(14,40)/ 13,9896
Maximum allowable indoor / outdoor capacity ratio		%	50-130	50-130	50-130	50-130	50-130	50-130
Operating range	Cool Min - Max	°C	-10 ~ +46	-10 ~ +46	-10 ~ +46	-10 ~ +46	-10 ~ +46	-10 ~ +46
	Heat Min - Max	°C	-20 ~ +18	-20 ~ +18	-20 ~ +18	-20 ~ +18	-20 ~ +18	-20 ~ +18

ErP data³⁾

SEER ⁴⁾	7,85	7,48	7,25	7,85	7,48	7,25
$\eta_{s,c}$	311,0%	296,2%	286,8%	311,0%	296,2%	286,8%
SCOP ⁴⁾	4,87	4,40	4,24	4,87	4,40	4,24
$\eta_{s,h}$	191,8%	172,9%	166,7%	191,8%	172,9%	166,7%

1) EER and COP calculation is based in accordance to EN14511. 2) In case of 1,5 kW indoor units connection, able to connect maximum 12 indoor units. 3) SEER / SCOP and $\eta_{s,c}$ / $\eta_{s,h}$ are in accordance with ErP test data for F2 type variable static pressure hide-away indoor units. Eurovent certified. 4) SEER / SCOP is calculated based on the seasonal space cooling / heating efficiency " η " values of the COMMISSION REGULATION (EU) 2016/2281. SEER, SCOP = (η + Correction) × PEF.

For light commercial use

Mini ECOi allows easier installation in condominiums and medium sized buildings with limited spaces. Utilising R410A and DC Inverter technology, Panasonic offers VRF to a new and growing market.

Reduced height of 996 mm

In addition to raising efficiency, the outdoor unit has been designed to be as compact as possible. It can now be installed in places that were previously too small.



INTERNET CONTROL: Optional.

Mini ECOi LE1 Series high efficiency 8 and 10 HP · R410A

Prepare to be blown away by Panasonic's Mini VRF system.

The Mini VRF compact system is the ideal solution for minimum outdoor space.

Panasonic extends the Mini VRF range by 8 and 10 HP units.

- Piping flexibility with 150 m maximum length
- High efficiency
- Connection of up to 15 indoor units
- Quiet operation mode (one of the lowest in the market)
- High ambient temp performance
- High static pressure 35 Pa



HP			8 HP	10 HP
Outdoor unit			U-8LE1E8	U-10LE1E8
Power supply	Voltage	V	380-400-415	380-400-415
	Phase		Three phase	Three phase
	Frequency	Hz	50	50
Cooling capacity		kW	22,4	28,0
EER ¹⁾		W/W	3,80	3,11
Current		A	9,60 - 9,15 - 8,80	14,70 - 14,00 - 13,50
Input power		kW	5,89	9,00
Heating capacity		kW	25,0	28,0
COP ¹⁾		W/W	4,02	3,93
Current		A	10,20 - 9,65 - 9,30	11,60 - 11,10 - 10,70
Input power		kW	6,22	7,13
Starting current		A	1,00	1,00
Maximum current		A	13,70	19,60
Maximum input power		kW	9,16	13,10
Maximum number of connectable indoor units ²⁾			15	15
External static pressure		Pa	0 - 35	0 - 35
Air flow		m ³ /min	150	160
Sound pressure	Cool	dB(A)	60	63
	Cool (Silent 1/2/3)	dB(A)	57/55/53	60/58/56
	Heat	dB(A)	64	65
Sound power	Cool / Heat	dB(A)	81/85	84/86
Dimension	H x W x D	mm	1500 x 980 x 370	1500 x 980 x 370
Net weight		kg	132	133
Piping diameter	Liquid	Inch (mm)	3/8(9,52) ³⁾ /1/2(12,70) ⁴⁾	3/8(9,52) ³⁾ /1/2(12,70) ⁴⁾
	Gas	Inch (mm)	3/4(19,05) ³⁾ /7/8(22,22) ⁴⁾	7/8(22,22) ³⁾ /1(25,40) ⁴⁾
Maximum piping length (total)		m	7,5 - 150(7,5 - 300)	7,5 - 150(7,5 - 300)
Elevation difference (in / out)		m	50(OU above)/40(OU below)	50(OU above)/40(OU below)
Refrigerant (R410A) / CO ₂ Eq.		kg / T	6,30(24,00)/13,1544	6,60(24,00)/13,7808
Maximum allowable indoor / outdoor capacity ratio		%	50 - 130	50 - 130
Operating range	Cool Min ~ Max	°C	-10 ~ +46	-10 ~ +46
	Heat Min ~ Max	°C	-20 ~ +18	-20 ~ +18

ErP data ⁵⁾	8 HP	10 HP
SEER ⁶⁾	6,27	6,37
$\eta_{s,c}$	247,9%	251,8%
SCOP ⁶⁾	4,24	4,31
$\eta_{s,h}$	166,4%	169,5%

1) EER and COP calculation is based in accordance to EN14511. 2) If the heating utilized, it is necessary to increase 1 size with respect to the main liquid pipe, depending on the combination of the indoor unit. 3) Under 90 m for ultimate indoor unit. 4) Over 90 m for ultimate indoor unit. If the longest piping equivalent length exceeds 90 m, increase the sizes of the main tubes by 1 rank for gas and liquid pipes. 5) SEER / SCOP and $\eta_{s,c}$ / $\eta_{s,h}$ are in accordance with ErP test data for F2 type variable static pressure hide-away indoor units. Eurovent certified. 6) SEER / SCOP is calculated based on the seasonal space cooling / heating efficiency " η " values of the COMMISSION REGULATION (EU) 2016/2281. SEER, SCOP = (η + Correction) × PEF.

Increase external static pressure

When unit is installed on a narrow balcony, any barrier in front will be an obstacle. High external static pressure will overcome this obstacle and maintain operating capacity.

High ambient temperature performance

Cooling operation range up to 46 °C. The system can maintain the rated (100%) capacity up to 40 °C by 8 HP model and up to 37 °C by 10 HP model.



INTERNET CONTROL: Optional.



ECOi EX. The Game Changer



VRF with outstanding energy-saving performance and powerful operation SEER 7,56 (2-Pipe 18 HP model).



A game-changing VRF system delivering energy-saving performance, powerful operation, reliability and comfort surpassing anything previously possible.

It represents a true paradigm shift in air conditioning solutions. Taking quality to the extreme — that's the Panasonic challenge.

1 High performance at extreme conditions

ECOi EX is highly reliable, with strong cooling and heating power, even when operating at extreme ambient temperatures. The units can operate at 100% of capacity at 43 °C, reaching a great cooling operation up to 52 °C and in heating to -25 °C*.

Also, the ECOi EX features include Bluefin in the heat exchanger, improving efficiency in marine ambient. A silicone coated PCB (Printed Circuit Board) protects the unit from being damaged by environmental factors such as moisture and dust.

2 Outstanding efficiency and comfort

The ECOi EX system is designed to increase energy efficiency by delivering high SEER rating, as well as high efficiency for part-load operation.

The system has reduced energy costs thanks to "All-Inverter Compressors" with independent control, to deliver highly flexible performance. Also, the ECOi EX features an enlarged heat exchanger with triple surfaces that allow for improved heat transfer and a curved air discharge bell-mouth, for better aerodynamics. The three-stage oil recovery design makes it able to minimise the frequency of forced oil recovery, leading to reduced energy costs and sustained comfort.

3 Superior flexibility

With up to 1000* meters of pipeline, 30 meters maximum height difference between indoor units and maximum 90 meters between outdoor unit and indoor unit, the design possibilities have grown exponentially, making the ECOi EX the ideal air conditioning option for expansive buildings, such as train stations, airports, schools or hospitals. These advantages are enhanced with the wide range of indoor unit models and capacities, facilitating the perfect adaptation to all kinds of project. The careful selection of controls and peripherals such as the Pump Down, the AHU and / or the chiller, enables an optimised system selection. Maximum allowable indoor / outdoor connected capacity ratio of up to 200%.

* Conditions of 2-Pipe ECOi EX ME2 Series.



TOP efficiency and comfort

Remarkable improvement on key components: extraordinary energy-saving performance and redesigned for smooth and better air discharge.

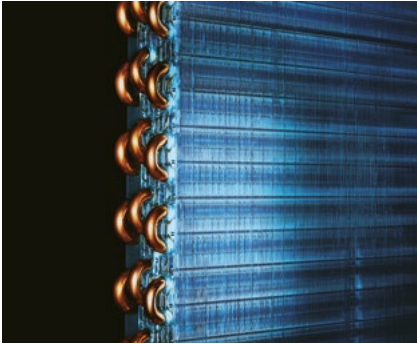

Enlarged heat exchanger surface area with triple rows.

* For 8 and 10 HP unit, the heat exchanger is 2 row design.



Multiple large-capacity all Inverter compressors (from 14 HP).



Designed curved air discharge bell mouth for better aerodynamics.

Improvements on refrigerant circuit

Compressor.

Redesigned components in the body provide performance improvements especially in the rated cooling condition and ASEER performance.



Accumulator.

Oil returning circuit with control valve makes efficient oil recovery to compressors.

Oil separator.

Modified tank design makes efficient oil separation with less pressure drop.



Receiver tank-less design

Improved refrigerant control program recovers the remaining refrigerant gas in the system back to the accumulator tank effectively.



Smooth exhaust flow by bell-mouth

The curved shape with integrated top and bottom assure smooth exhaust flow. This gives more air-volume with same sound level, less input power at same air flow.

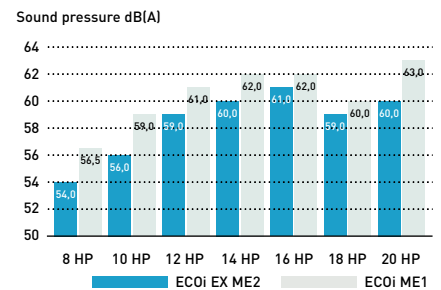
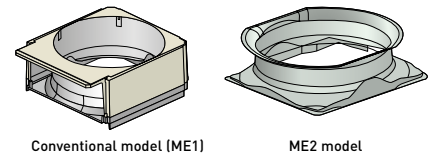

Combined 3 surface heat exchanger

The highly efficient piping pattern increases heat exchange performance by 5%. The heat exchanger features a 3 surface construction. Compared to the divided dual-surface construction in current models, there is no divided space and the face area of heat exchanger becomes larger.

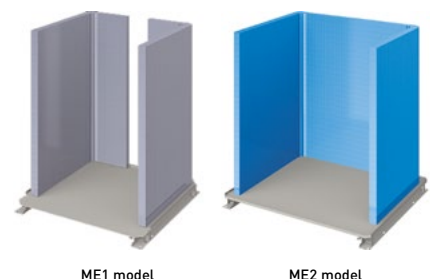

Oil recovery intelligent control

Oil recovery intelligent control advantages:

1. Higher efficiency
2. Durability
3. Comfort: continuous operation, low noise and low vibration

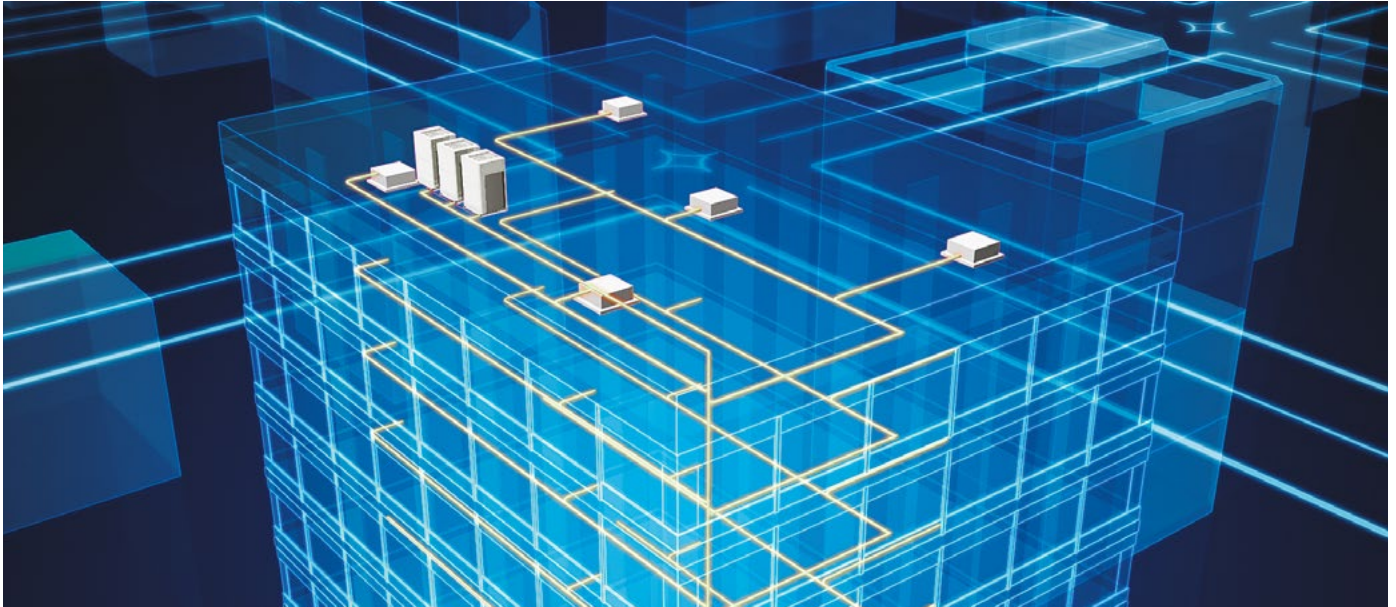

Intelligent 3-stage oil management system

In a VRF system, where lengthy piping and a large number of indoor units need to be controlled collectively, the key to maintaining the system's reliability is to ensure an appropriate amount of oil is secured in the compressors. In order to avoid oil shortage in the compressor, maximum operation is normally forcibly conducted at regular intervals to recover oil from indoor units. This method, typically employed in a standard VRF, causes the system to overheat or overcool and thus waste energy. In Panasonic VRF systems, a sensor for detecting oil levels is mounted in each compressor. In installations with multiple outdoor units, a shortage of oil in one compressor can be compensated for by recovering oil either from another compressor in the same unit, from a compressor in an adjacent outdoor unit, or from connected indoor units. Panasonic VRF systems provide users with a comfortable environment whilst saving energy.

The Panasonic system efficiently manages oil recovery in three stages; minimising the frequency of forced oil recovery while reducing energy cost and maintaining comfort.

STAGE-1: Panasonic compressors are equipped with sensors which monitor oil levels precisely at all times. If oil levels fall, oil can be transferred from other compressors within the same outdoor unit.

STAGE-2: If oil levels in all compressors within the outdoor unit fall, oil can be replenished from adjacent outdoor units.

STAGE-3: Forced oil recovery is implemented only if oil levels become insufficient in spite of above measures. The Panasonic system's design concept is radically different from conventional oil systems.

Features of oil recovery design

Oil sensors installed in each compressor.

Oil sensors installed in each Panasonic compressor precisely monitor oil levels, eliminating unnecessary oil recovery.

Highly functional oil separator.

Thanks to extended separate piping, oil recovery efficiency reaches 90%, minimising the oil discharged from the compressor.

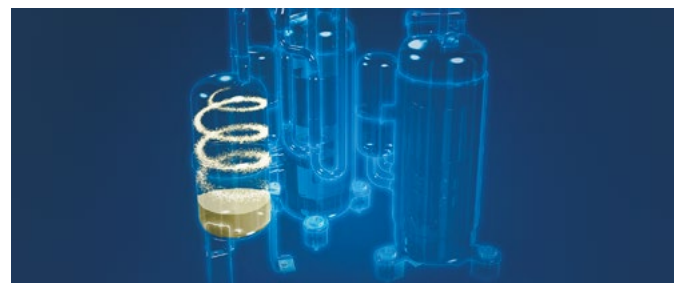
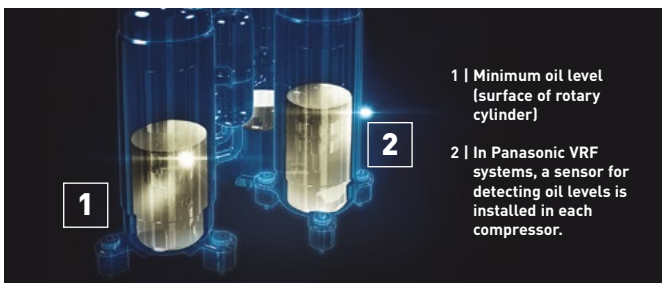

Twin rotary Inverter compressor

- Wider and flexible control on Inverter compressor
- Better oil lubrication
- Smooth start up

Extraordinary energy-saving performance

Designed for Actual Operation Performance. Panasonic builds air conditioning systems not only with a high EER for rated operation, but also with Seasonal-EER appropriate to the customer's actual environment of use. For instance, with rated operation, outdoor temperature is constant at 35 °C, but in reality the outdoor temperature is continuously changing. Consequently, required air conditioning performance also changes. That's why Panasonic implements the following kind of proprietary control.

Compressor efficiency electric system VRF. COP

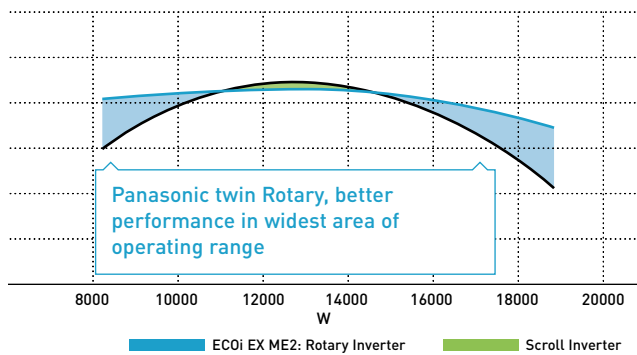

- 1 | Set temperature is rapidly attained; full-load operating time is kept to a minimum.
- 2 | The frequency of forced oil recovery is minimised. The volume of oil within the compressors is monitored precisely by sensors, so forced oil recovery under full-load operation is conducted only when necessary. Since this suppresses noise due to oil recovery, comfort is maintained.
- 3 | Panasonic pursues a high EER, of course, as well as high EER in part load, for energy saving performance under a broad range of loads.

Panasonic's design concept contributes to substantial energy cost reductions.

Number of Inverter compressors.

Size	2-Pipe ECOi EX ME2						3-Pipe ECOi EX MF3					
	Small		Medium			Large	Medium					
HP	8	10	12	14	16	18	20	8	10	12	14	16
Number	1 pc.		1 pc.	2 pcs.	2 pcs.			1 pc.			2 pcs.	

Actual operation data graph of Panasonic VRF

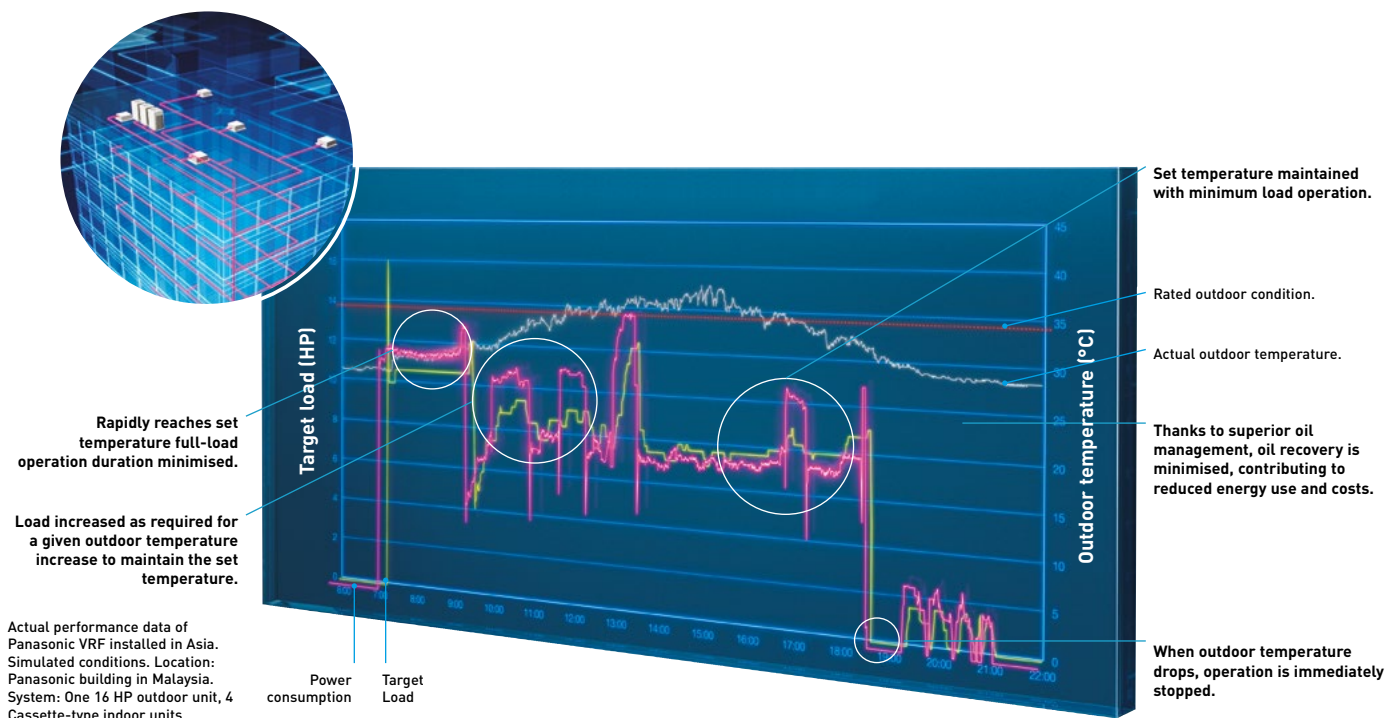

Superior quality, reliability and durability

Two independently controlled Inverter compressors achieve high efficiency. Redesigned components in the body provide performance improvement especially in the rated cooling condition and EER performance.

High safety operation in case of breakdown!

Automatic Back-Up operation. Ensures heating and cooling.

It is possible for the system to keep working, even if the compressors, fan motor and the temperature sensor are damaged (even when a compressor fails in single unit with 2 compressors inside).

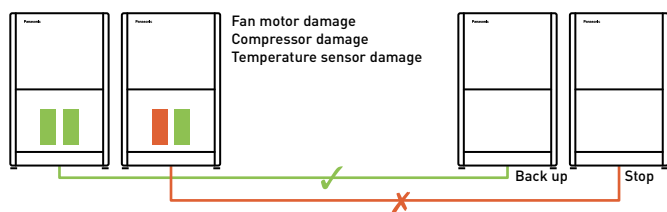

The system will still operate with only 25% of the connected indoor units.

System will not stop when only 25% of indoor units have power supply and breakdown on other indoor units.

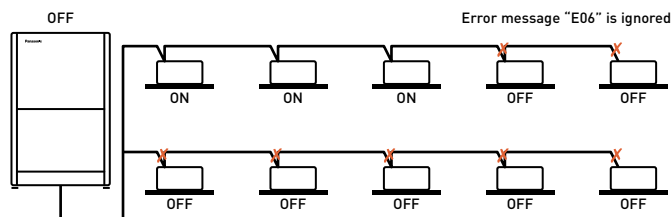

Hi-durability outdoor unit

Treated for high resistance to corrosion (rust and salty air) to ensure long-lasting performance.

Note: Selecting this unit does not completely eliminate the possibility of rust developing. For details concerning unit installation and maintenance, please consult an authorised dealer.

Specially protected parts.

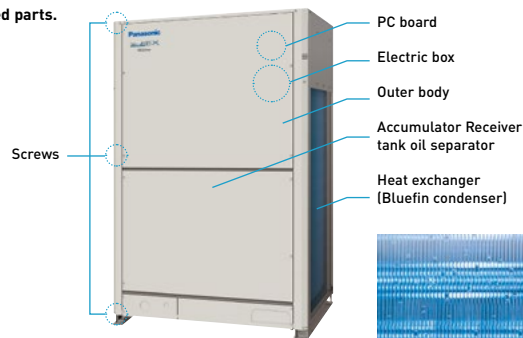

Extended compressor life by uniform compressor operation time

The total run-time of compressors are monitored by a built-in microcomputer, which ensures that operation times of all compressors within the same refrigerant circuit are balanced.

Compressors with histories showing shorter run times are selected first, ensuring equal wear and tear across all units and extending the working life of the system.

System example.

A,C: DC Inverter compressor

B,D: Constant speed compressor

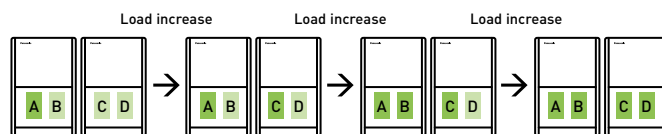

50 h 30 h 60 h 10 h

* Depend on accumulated operation time of each compressors.

* Compressor priority has possibility to be changed.

[e.g] Case 1: A>C>B>D, Case 2: C>A>D>B, Case 3: A>C>D>B, Case 4: C>A>B>D

* Also other cases available.

A large number of indoor unit models can be connected.



2-Pipe ECOi EX ME2 Series



Extraordinary partial load, SEER and SCOP.

Efficiency in VRF systems

In the past it was only possible to compare the nominal efficiency at outdoor ambient temperature of 35 °C (EER) in Cooling and at 7 °C in heating (COP). With EN-14825 seasonal efficiency will be shown, the result will be SEER and SCOP. ECOi EX is reaching excellent performance without using any additional saving functions.

The highest EER / COP rating in most capacities

Compared to conventional model ECOi (ME1)

The ECOi EX marks a revolutionary step forward in VRF efficiency. A look at the incredible EER / COP value clearly indicates that. What's more, this high EER / COP value is achieved even during part load operation. This shows the extraordinary energy-saving performance the ECOi EX is capable of providing.

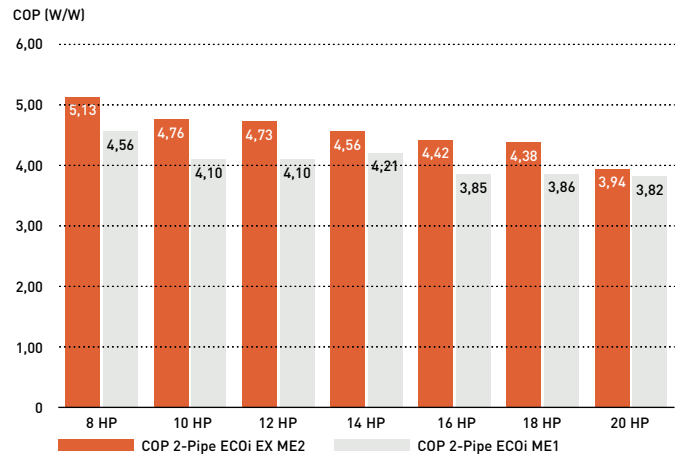
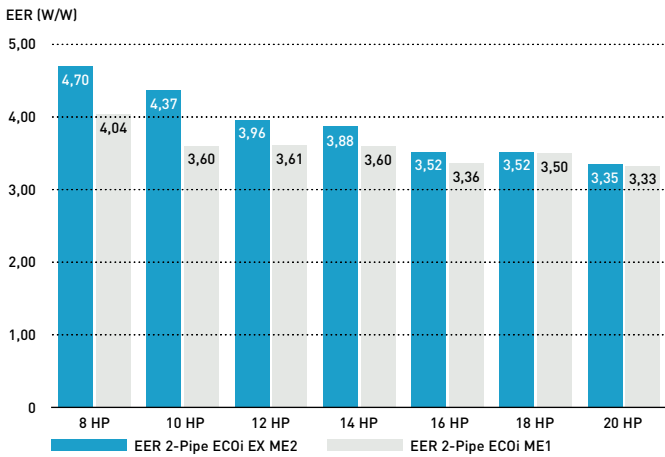

Partial load for seasonal and real system efficiency

VRF units are designed to adapt to the heating and cooling demand, adapting its performance to different outdoor conditions. When compressor runs at lower than 100% capacity, the system is working at partial load. A wider compressor operating range results in better system performance both at full load and partial load conditions. Panasonic ECOi EX partial load is excellent, reaching a minimum of 15% of compressor capacity.

Excellent efficiency at any condition and partial load

In both heating and cooling mode, Panasonic ECOi EX is reaching exceptional levels of efficiency.

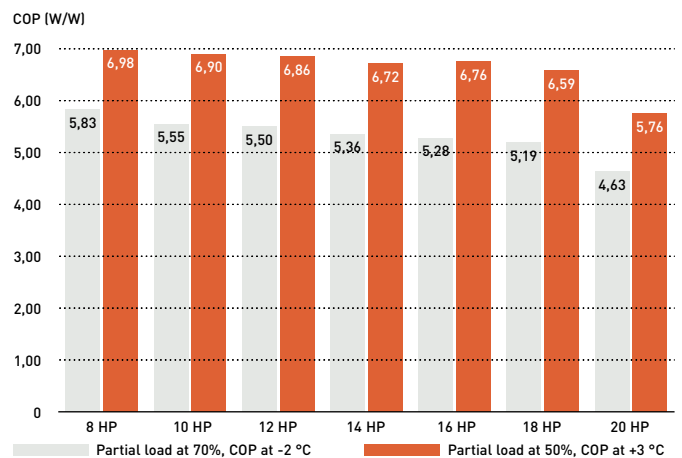
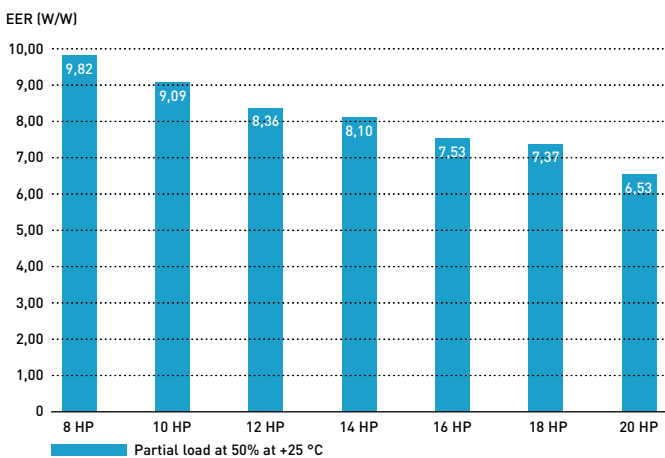

SEER and SCOP following EN-14825

When better partial load, better efficiency is achieved in real operation. The EN-14825 is showing the way to calculate considering full year operation hours at different conditions. Panasonic ECOi EX is designed to save energy in any partial load condition. During most operation hours a system is under partial load conditions, 80% of total operation hours is less than 70% of full load.

In below graphs is the example for average ambient conditions, this uses Strasbourg ambient conditions for calculation.

Outside temperature distribution.

Time distribution (hours / year)

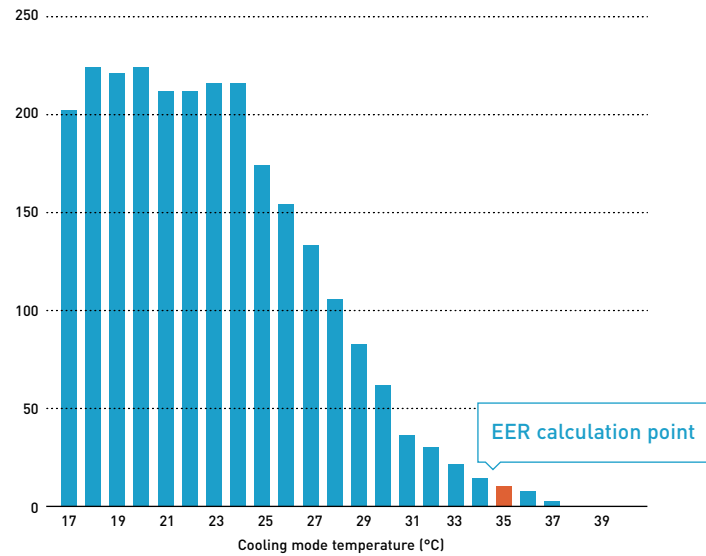

Outside temperature distribution.

Time distribution (hours / year)

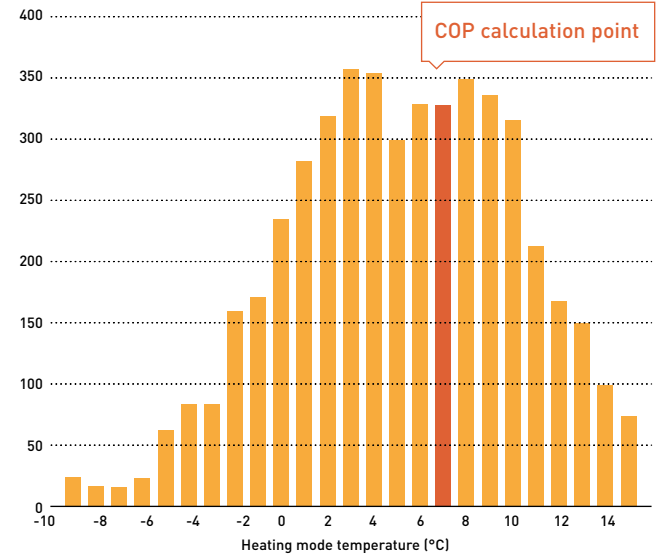

In the characteristics EER and COP only a single temperature for the assessment of the efficiency is taken as a basis in each case. Data calculated under EN-14825 conditions, not additional saving function considered for this calculation. Compressor frequency according to ambient temperature and building design.

SEER and SCOP values

ECOi EX models have superior seasonal space cooling / heating efficiency following not only EN 14825 but also COMMISSION REGULATION (EU) 2016/2281. This regulation requires to use "η" values in the technical documents.

Please visit our websites www.aircon.panasonic.eu or www.ptc.panasonic.eu.

During commissioning, Panasonic can further increase efficiency by "20%" increasing evaporation refrigerant temperature range, for a higher efficiency and lower energy consumption.

SEER / SCOP

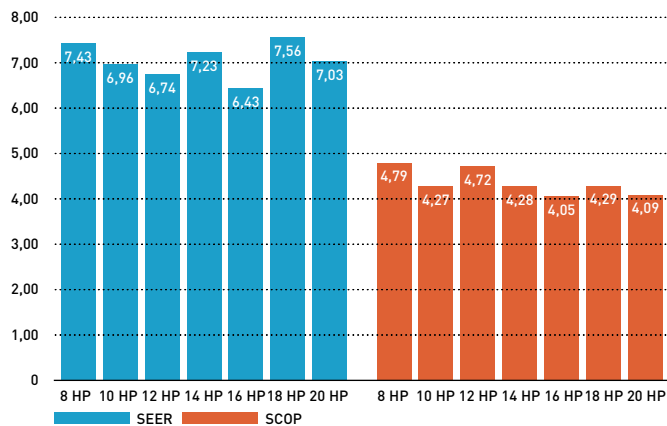

ESEER (W/W)

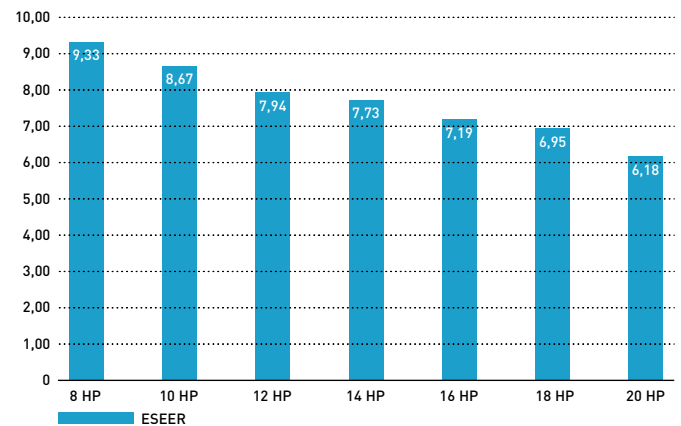

2-Pipe ECOi EX ME2 Series high performance at extreme conditions

The ECOi EX can still operate at 100% capacity when the outside temperature is as high as 43 °C. This high power capability enables reliable operation even under extremely high temperature conditions.

Extremely high capacity at -20 °C and unique heating capacity at -25 °C

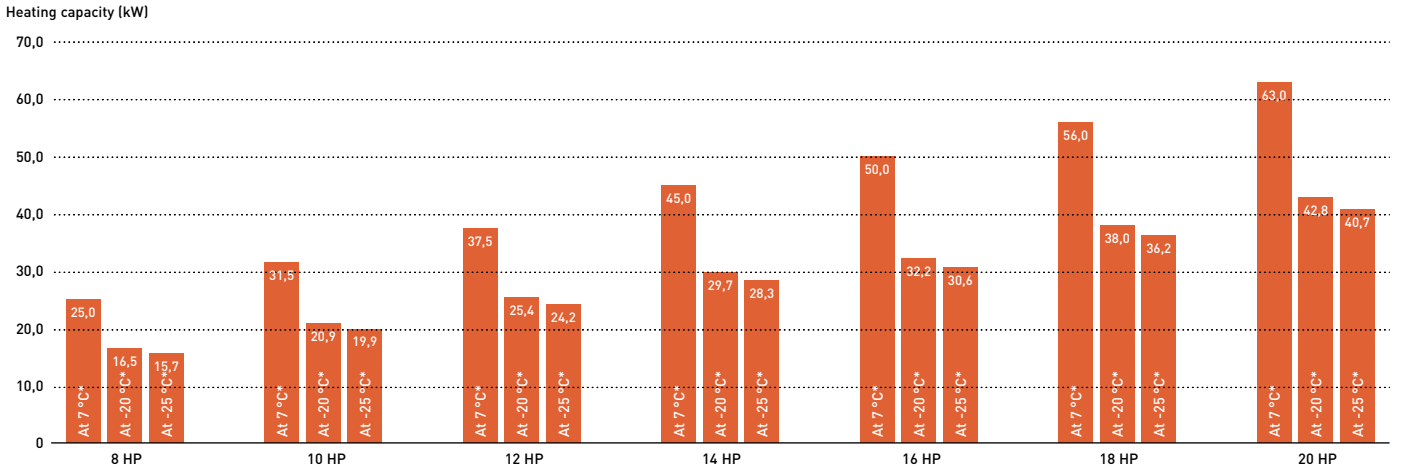

* Outdoor air temperature [°C WB].

Trusted reliability even under high and low temperature conditions

Designed to be durable enough to withstand extreme heat, 2-Pipe ECOi EX ME2 Series ensures reliable cooling operation over an extended operating range up to 52 °C, and heating operation also at -25 °C.

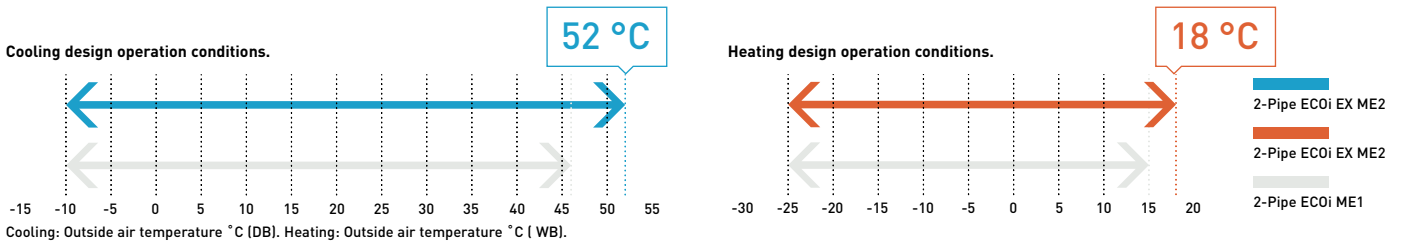

2-Pipe ECOi EX ME2 Series superior flexibility

Maximum allowable connected indoor / outdoor capacity ratio up to 200%*

ECOi EX attain maximum indoor unit connection capacity of up to 130% of the unit's connection range. This limit can be surpassed and reach up to 200% if some conditions are satisfied. With this feature, ECOi EX provides an ideal air conditioning solution for locations where full cooling / heating are not always required in all spaces at same time.

System (HP)	8	10	12	14	16	18	20	22	24	26	28	30	32	34	36	38	40	42	44	46	48	50	52	54	56	58	60	62	64	66	68	70	72	74	76	78	80						
Connectable indoor units: 130%	13	16	19	23	26	29	33	36	40	43	46	50	53	56	59															64													
Connectable indoor units: 200%	20	25	30	35	40	45	50	55	60											64																							

Note: If more than 100% indoor units are operated with a high load, the units may not perform at the rated capacity. For the details, please consult with an authorised Panasonic dealer. * If the following conditions are satisfied, the effective range is above 130% up to 200%. Obey the limited number of connectable indoor units. The lower limit of operating range for heating outdoor temperature is limited to -10 °C WB (standard -25 °C WB). Simultaneous operation is limited to less than 130% of connectable indoor units. 1.5 kW capacity of Indoor Units are included.

Increased piping lengths and design flexibility

Adaptable to various building types and sizes. Actual piping length: 200 m. Maximum piping length: 1000 m.

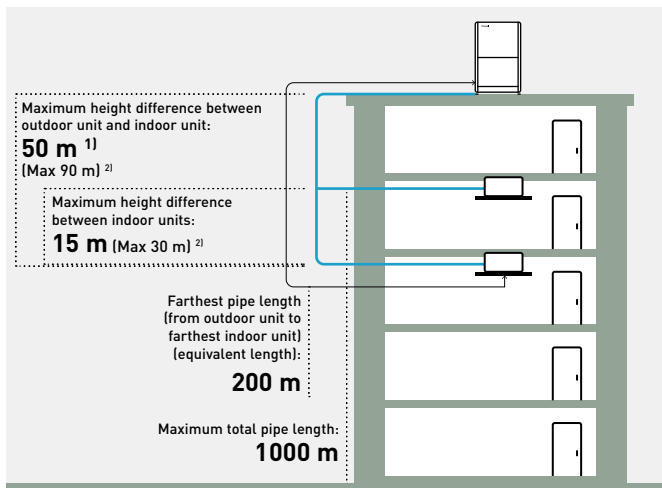

1) 40 m if the outdoor unit is below the indoor unit.
2) For height differences between outdoor unit and indoor unit > 50 m, as well as for height differences between indoor units > 15 m, contact an authorized Panasonic dealer.

Up to 50 m length difference between the longest and the shortest piping from the first branch

Flexible piping layout makes it easier to design systems for locations such as train stations, airports, schools and hospitals.

- Up to 64 units can be connected to one system
- Difference between maximum and minimum pipe runs after first branch can be a maximum of 50 m
- Larger pipe runs can be up to 200 m

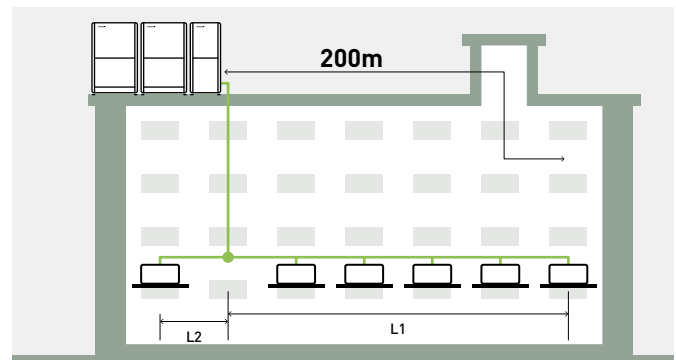

Compact design

The ME2 Series has reduced the installation space required with up to 20 HP available in a single chassis. 8 - 10 HP are able to fit inside a lift for easy handling on site.

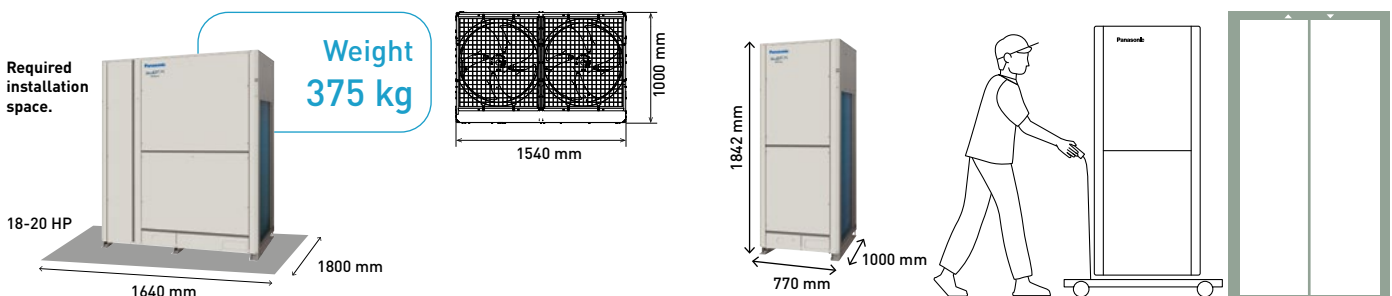

2-Pipe ECOi EX ME2 Series piping design

Select installation locations so that the lengths and sizes of refrigerant piping are within the allowable ranges shown in the figure below.

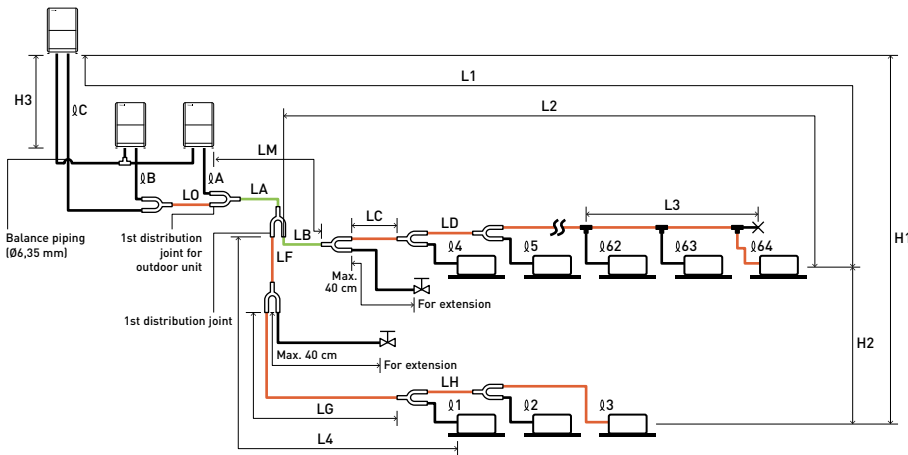

The outdoor connection main piping (LO portion) is determined by the total capacity of the outdoor units that are connected to the tube ends.

Note: Be sure to use special R410A distribution joints (CZ: optional parts) for outdoor unit connections and piping branches.

R410A distribution joint.

- CZ-P680PH2BM (for outdoor unit)
- CZ-P1350PH2BM (for outdoor unit)
- CZ-P224BK2BM (for indoor unit)
- CZ-P680BK2BM (for indoor unit)
- CZ-P1350BK2BM (for indoor unit)

Main piping length (maximum piping size) LM= LA + LB ...

Main distribution tubes LC – LH are selected according to the capacity after the distribution joint.

Sizes of indoor unit connection piping Ø1 – Ø64 are determined by the connection piping sizes on the indoor units.

Distribution joint (CZ: optional parts).

Ball valve (field supply).

T-joint (field supply).

Solidly welded shut (pinch weld).

Ranges that apply to refrigerant piping lengths and to differences in installation heights

Items	Mark	Contents	Length (m)
Allowable piping length	L1	Maximum piping length	Actual length ≤200 ¹⁾ Equivalent length ≤210 ¹⁾
	Δ L (L2-L4)	Difference between maximum length and minimum length from the 1st distribution joint	≤50 ²⁾
	LM	Maximum length of main piping (at maximum size) * Even after 1st distribution joint, LM is allowed if at maximum piping length.	— ³⁾
	Ø1, Ø2- Ø64	Maximum length of each distribution tube	≤50 ⁴⁾
	L1+ Ø1+ Ø2- Ø63+ ØA+ØB+LF+LG+LH	Total maximum piping length including length of each distribution tube (only liquid piping)	≤1000
Allowable elevation difference	ØA, ØB+LO, ØC+LO	Maximum piping length from outdoor's 1st distribution joint to each outdoor unit	≤10
	H1	When outdoor unit is installed higher than indoor unit	≤50
	H2	When outdoor unit is installed lower than indoor unit	≤40
	H3	Maximum difference between indoor units	≤15
Allowable length of joint piping	L3	T-joint piping (field-supply); Maximum piping length between the first T-joint and solidly welded-shut end point	≤2

L = Length, H = Height

1) If the longest piping length (L1) exceeds 90 m (equivalent length), increase the sizes of the main tubes (LM) by 1 rank for gas tubes and liquid tubes. Use a field supply reducer. Select the tube size from the table of main piping sizes (Table 3) and from the table of refrigerant piping sizes (Table 8). 2) When the piping length exceeds 40 m, increase a longer liquid or gas piping by 1 rank. Refer to the Technical Data for the details. 3) If the longest main piping length (LM) exceeds 50 m, increase the main piping size at the portion before 50 m by 1 rank for the gas tubes. Use a field supply reducer. Determine the length less than the limitation of allowable maximum piping length. For the portion that exceeds 50 m, set based on the main piping size (LA) listed in Table 3. 4) If any of the piping length exceeds 30 m, increase the size of the liquid and gas tubes by 1 rank. 5) If the total distribution piping length exceeds 500 m, maximum allowable elevation difference (H2) between the indoor units is calculated by the following formula. Make sure the indoor unit's actual elevation difference should fall within the figure calculated as follows. Unit of account (meter): $15 \times [2 - \text{total piping length (m)} \div 500]$.

* The outdoor connection main piping (LO portion) is determined by the total capacity of the outdoor units that are connected to the tube ends. If the size of the existing piping is already larger than the standard piping size, it is not necessary to further increase the size. ** If the existing piping is used, and the amount of on-site refrigerant charge exceeds the value listed below, then change the size of the piping to reduce the amount of refrigerant. Total amount of refrigerant for the system with 1 outdoor unit: 50kg. Total amount of refrigerant for the system with 2 outdoor units: 80kg. Total amount of refrigerant for the system with 3 outdoor units or 4 outdoor units: 105 kg.

Necessary amount of additional refrigerant charge per outdoor unit.

U-8ME2E8	U-10ME2E8	U-12ME2E8	U-14ME2E8	U-16ME2E8
5,5 kg	5,5 kg	7,0 kg	7,0 kg	7,0 kg

System limitations.

Maximum number allowable connected outdoor units	4 ¹⁾
Maximum capacity allowable connected outdoor units	224 kW (80 HP)
Maximum connectable indoor units	64 ²⁾
Maximum allowable indoor / outdoor capacity ratio	50-130% ³⁾

- 1) Up to 4 units can be connected if the system has been extended.
- 2) In the case of 38 HP or smaller units, the number is limited by the total capacity of the connected indoor units.
- 3) If the following conditions are satisfied, the effective range is above 130% and below 200%.
 - A) Obey the limited number of connectable indoor units. B) The lower limit of operating range for heating outdoor temperature is limited to -10 °C WB (standard -25 °C WB). C) Simultaneous operation is limited to less than 130% of connectable indoor units.

Additional refrigerant charge.

Liquid piping size (Inch (mm))	1/4 (6,35)	3/8 (9,52)	1/2 (12,70)	5/8 (15,88)	3/4 (19,05)	7/8 (22,22)	1 (25,40)
	Amount of refrigerant charge (g/m)	26	56	128	185	259	366

Refrigerant piping (existing piping can be used).

Piping size (mm)				Material Temper - 1/2 H, H									
Material Temper - O													
Ø6,35	t 0,8	Ø12,70	t 0,8	Ø19,05	t 1,2	Ø22,22	t 1,0	Ø28,58	t 1,0	Ø38,10	over t 1,35	Ø44,45	over t1,55
Ø9,52	t 0,8	Ø15,88	t 1,0			Ø25,40	t 1,0	Ø31,75	t 1,1	Ø41,28	over t 1,45	Ø44,45	over t1,55

* When bending the tubes, use a bending radius that is at least 4 times the outer diameter of the tubes. In addition, take sufficient care to avoid crushing or damaging the tubes when bending them.

2-Pipe ECOi EX ME2 Series

A VRF system delivering energy-saving performance, powerful operation, reliability and comfort, surpassing anything previously possible. It represents a true paradigm shift in air conditioning solutions.

VRF with outstanding energy-saving performance and powerful operation SEER 7,56 (18 HP model).



			8 HP	10 HP	12 HP	14 HP	16 HP	18 HP	20 HP
Outdoor unit			U-8ME2E8	U-10ME2E8	U-12ME2E8	U-14ME2E8	U-16ME2E8	U-18ME2E8	U-20ME2E8
Power supply	Voltage	V	380-400-415	380-400-415	380-400-415	380-400-415	380-400-415	380-400-415	380-400-415
	Phase		Three phase	Three phase	Three phase	Three phase	Three phase	Three phase	Three phase
	Frequency	Hz	50	50	50	50	50	50	50
Cooling capacity		kW	22,4	28,0	33,5	40,0	45,0	50,0	56,0
EER ¹⁾		W/W	4,70	4,37	3,96	3,88	3,52	3,52	3,35
ESEER		W/W	9,33	8,67	7,94	7,73	7,19	6,95	6,18
Current		A	7,79-7,40-7,14	10,70-10,20-9,80	13,70-13,00-12,50	17,40-16,50-15,90	21,10-20,10-19,40	23,20-22,00-21,20	26,70-25,40-24,50
Input power		kW	4,77	6,41	8,47	10,30	12,80	14,20	16,70
Heating capacity		kW	25,0	31,5	37,5	45,0	50,0	56,0	63,0
COP ¹⁾		W/W	5,13	4,76	4,73	4,56	4,42	4,38	3,94
Current		A	7,96-7,56-7,29	11,10-10,50-10,10	12,90-12,30-11,80	16,60-15,80-15,20	18,90-17,90-17,30	21,10-20,10-19,40	25,90-24,60-23,70
Input power		kW	4,87	6,62	7,92	9,86	11,30	12,80	16,00
Starting current		A	1,00	1,00	1,00	2,00	2,00	2,00	2,00
External static pressure (Max)		Pa	80	80	80	80	80	80	80
Air flow		m ³ /min	224	224	232	232	232	405	405
Sound pressure	Normal mode	dB(A)	54	56	59	60	61	59	60
	Silent mode	dB(A)	51	53	56	57	58	56	57
Sound power	Normal mode	dB(A)	75	77	80	81	82	80	81
Dimension	H x W x D	mm	1842 x 770 x 1000	1842 x 770 x 1000	1842 x 1180 x 1000	1842 x 1180 x 1000	1842 x 1180 x 1000	1842 x 1540 x 1000	1842 x 1540 x 1000
Net weight		kg	210	210	270	315	315	375	375
Piping diameter ²⁾	Liquid	Inch (mm)	3/8(9,52)/1/2(12,70)	3/8(9,52)/1/2(12,70)	1/2(12,70)/5/8(15,88)	1/2(12,70)/5/8(15,88)	1/2(12,70)/5/8(15,88)	5/8(15,88)/3/4(19,05)	5/8(15,88)/3/4(19,05)
	Gas	Inch (mm)	3/4(19,05)/7/8(22,22)	7/8(22,22)/1(25,40)	1(25,40)/1-1/8(28,58)	1(25,40)/1-1/8(28,58)	1-1/8(28,58)/1-1/4(31,75)	1-1/8(28,58)/1-1/4(31,75)	1-1/8(28,58)/1-1/4(31,75)
	Balance	Inch (mm)	1/4(6,35)	1/4(6,35)	1/4(6,35)	1/4(6,35)	1/4(6,35)	1/4(6,35)	1/4(6,35)
Refrigerant (R410A) / CO ₂ Eq		kg/T	5,60/11,6928	5,60/11,6928	8,30/17,3304	8,30/17,3304	8,30/17,3304	9,50/19,836	9,50/19,836
Maximum allowable indoor / outdoor capacity ratio % ³⁾			50 ~ 130(200)	50 ~ 130(200)	50 ~ 130(200)	50 ~ 130(200)	50 ~ 130(200)	50 ~ 130(200)	50 ~ 130(200)
Operating range	Cool Min ~ Max	°C	-10 ~ +52	-10 ~ +52	-10 ~ +52	-10 ~ +52	-10 ~ +52	-10 ~ +52	-10 ~ +52
	Heat Min ~ Max	°C	-25 ~ +18	-25 ~ +18	-25 ~ +18	-25 ~ +18	-25 ~ +18	-25 ~ +18	-25 ~ +18

ErP data⁴⁾

SEER ⁵⁾	7,43	6,96	6,74	7,23	6,43	7,56	7,03
$\eta_{s,c}$	294,3%	275,4%	266,6%	286,0%	254,3%	299,2%	278,2%
SCOP ⁵⁾	4,79	4,27	4,72	4,28	4,05	4,29	4,09
$\eta_{s,h}$	188,4%	167,6%	185,8%	168,2%	159,0%	168,7%	160,4%

1) EER and COP calculation is based in accordance to EN14511. 2) Piping diameter under 90 m for ultimate indoor unit / over 90 m for ultimate indoor unit (if the longest piping equivalent length exceeds 90 m, increase the sizes of the main tubes by 1 rank for gas tubes and liquid tubes). 3) If the following conditions are satisfied, the effective range is above 130% and below 200%: A. Obey the limited number of connectable indoor units. B. The lower limit of operating range for heating outdoor temperature is limited to -10 °C WB (standard -25 °C WB). C. Simultaneous operation is limited to less than 130% of connectable indoor units. 4) SEER / SCOP and $\eta_{s,c}$ / $\eta_{s,h}$ are in accordance with ErP test data for F2 type variable static pressure hide-away indoor units. Eurovent certified. 5) SEER / SCOP is calculated based on the seasonal space cooling / heating efficiency $\eta_{s,c}$ / $\eta_{s,h}$ values of the COMMISSION REGULATION (EU) 2016/2281. SEER, SCOP = (η + Correction) × PEF.

Technical focus

- Twin rotary Inverter compressor
- High performance at extreme conditions
- Outstanding efficiency and comfort
- Extraordinary partial load, SEER and SCOP
- SEER and SCOP following EN-14825
- Oil recovery intelligent control
- Top comfort
- Superior flexibility
- Bluefin full line up EX
- Extremely high capacity at -20 °C and unique heating capacity at -25 °C
- Smooth exhaust flow by bell-mouth



2-Pipe ECOi EX ME2 Series high efficiency model combination from 18 to 64 HP

			18 HP	20 HP	22 HP	24 HP	26 HP	28 HP
			U-8ME2E8	U-10ME2E8	U-10ME2E8	U-12ME2E8	U-10ME2E8	U-12ME2E8
			U-10ME2E8	U-10ME2E8	U-12ME2E8	U-12ME2E8	U-16ME2E8	U-16ME2E8
Outdoor unit	Voltage	V	380-400-415	380-400-415	380-400-415	380-400-415	380-400-415	380-400-415
	Phase		Three phase	Three phase	Three phase	Three phase	Three phase	Three phase
	Frequency	Hz	50	50	50	50	50	50
Cooling capacity	kW		50,0	56,0	61,5	68,0	73,0	78,5
EER ¹⁾	W/W		4,55	4,38	4,13	3,93	3,80	3,69
Current	A		18,20-17,30-16,60	21,40-20,30-19,60	24,30-23,10-22,30	28,00-26,60-25,60	31,70-30,10-29,00	34,80-33,10-31,90
Input power	kW		11,00	12,80	14,90	17,30	19,20	21,30
Heating capacity	kW		56,0	63,0	69,0	76,5	81,5	87,5
COP ¹⁾	W/W		4,96	4,77	4,76	4,69	4,55	4,56
Current	A		18,70-17,70-17,10	22,00-20,90-20,20	23,90-22,70-21,90	26,60-25,30-24,40	29,90-28,40-27,40	31,70-30,10-29,00
Input power	kW		11,30	13,20	14,50	16,30	17,90	19,20
Starting current	A		2,00	2,00	2,00	2,00	3,00	3,00
External static pressure (Max)	Pa		80	80	80	80	80	80
Air flow	m ³ /min		448	448	456	464	456	464
Sound pressure	Normal	dB(A)	58,5	59,0	61,0	62,0	62,5	63,5
	Silent mode	dB(A)	55,5	56,0	58,0	59,0	59,5	60,5
Sound power	Normal mode	dB(A)	79,5	80,0	82,0	83,0	83,5	84,5
Dimension / Net weight	HxWxD	mm / kg	1842 x 1600 x 1000/420	1842 x 1600 x 1000/420	1842 x 2010 x 1000/480	1842 x 2420 x 1000/540	1842 x 2010 x 1000/535	1842 x 2420 x 1000/585
	Liquid	Inch (mm)	5/8(15,88)/3/4(19,05)	5/8(15,88)/3/4(19,05)	5/8(15,88)/3/4(19,05)	5/8(15,88)/3/4(19,05)	3/4(19,05)/7/8(22,22)	3/4(19,05)/7/8(22,22)
Piping diameter ²⁾	Gas	Inch (mm)	1-1/8(28,58)/1-1/4(31,75)	1-1/8(28,58)/1-1/4(31,75)	1-1/8(28,58)/1-1/4(31,75)	1-1/8(28,58)/1-1/4(31,75)	1-1/4(31,75)/1-1/2(38,10)	1-1/4(31,75)/1-1/2(38,10)
	Balance	Inch (mm)	1/4(6,35)	1/4(6,35)	1/4(6,35)	1/4(6,35)	1/4(6,35)	1/4(6,35)
	Refrigerant (R410A) / CO ₂ Eq.	kg / T	11,20/23,3856	11,20/23,3856	13,90/29,0232	16,60/34,6608	13,90/29,0232	16,60/34,6608
Maximum allowable indoor / outdoor capacity ratio % ³⁾			50 ~ 130(200)	50 ~ 130(200)	50 ~ 130(200)	50 ~ 130(200)	50 ~ 130(200)	50 ~ 130(200)
Operating range	Cool Min ~ Max	°C	-10 ~ +52	-10 ~ +52	-10 ~ +52	-10 ~ +52	-10 ~ +52	-10 ~ +52
	Heat Min ~ Max	°C	-25 ~ +18	-25 ~ +18	-25 ~ +18	-25 ~ +18	-25 ~ +18	-25 ~ +18

			30 HP	32 HP	34 HP	36 HP	38 HP	40 HP
			U-14ME2E8	U-16ME2E8	U-10ME2E8	U-12ME2E8	U-10ME2E8	U-12ME2E8
			U-16ME2E8	U-16ME2E8	U-12ME2E8	U-12ME2E8	U-16ME2E8	U-16ME2E8
Outdoor unit	Voltage	V	380-400-415	380-400-415	380-400-415	380-400-415	380-400-415	380-400-415
	Phase		Three phase	Three phase	Three phase	Three phase	Three phase	Three phase
	Frequency	Hz	50	50	50	50	50	50
Cooling capacity	kW		85,0	90,0	96,0	101,0	107,0	113,0
EER ¹⁾	W/W		3,68	3,52	4,05	3,95	3,84	3,75
Current	A		38,60-36,60-35,30	42,30-40,20-38,70	38,70-36,80-35,50	41,40-39,30-37,90	46,10-43,80-42,20	49,20-46,70-45,00
Input power	kW		23,10	25,60	23,70	25,60	27,90	30,10
Heating capacity	kW		95,0	100,0	108,0	113,0	119,0	127,0
COP ¹⁾	W/W		4,48	4,42	4,72	4,73	4,61	4,57
Current	A		35,40-33,60-32,40	37,70-35,80-34,60	37,80-35,90-34,60	39,00-37,10-35,80	42,60-40,50-39,00	45,90-43,60-42,00
Input power	kW		21,20	22,60	22,90	23,90	25,80	27,80
Starting current	A		4,00	4,00	3,00	3,00	4,00	4,00
External static pressure (Max)	Pa		80	80	80	80	80	80
Air flow	m ³ /min		464	464	688	696	688	696
Sound pressure	Normal	dB(A)	63,5	64,0	63,0	64,0	64,0	64,5
	Silent mode	dB(A)	60,5	61,0	60,0	61,0	61,0	61,5
Sound power	Normal mode	dB(A)	84,5	85,0	84,0	85,0	85,0	85,5
Dimension / Net weight	HxWxD	mm / kg	1842 x 2420 x 1000/630	1842 x 2420 x 1000/630	1842 x 3250 x 1000/750	1842 x 3660 x 1000/810	1842 x 3250 x 1000/795	1842 x 3660 x 1000/855
	Liquid	Inch (mm)	3/4(19,05)/7/8(22,22)	3/4(19,05)/7/8(22,22)	3/4(19,05)/7/8(22,22)	3/4(19,05)/7/8(22,22)	3/4(19,05)/7/8(22,22)	3/4(19,05)/7/8(22,22)
Piping diameter ²⁾	Gas	Inch (mm)	1-1/4(31,75)/1-1/2(38,10)	1-1/4(31,75)/1-1/2(38,10)	1-1/4(31,75)/1-1/2(38,10)	1-1/2(38,10)/1-5/8(41,28)	1-1/2(38,10)/1-5/8(41,28)	1-1/2(38,10)/1-5/8(41,28)
	Balance	Inch (mm)	1/4(6,35)	1/4(6,35)	1/4(6,35)	1/4(6,35)	1/4(6,35)	1/4(6,35)
	Refrigerant (R410A) / CO ₂ Eq.	kg / T	16,60/34,6608	16,60/34,6608	22,20/46,3536	24,90/51,9912	22,20/46,3536	24,90/46,3536
Maximum allowable indoor / outdoor capacity ratio % ³⁾			50 ~ 130(200)	50 ~ 130(200)	50 ~ 130(200)	50 ~ 130(200)	50 ~ 130(200)	50 ~ 130(200)
Operating range	Cool Min ~ Max	°C	-10 ~ +52	-10 ~ +52	-10 ~ +52	-10 ~ +52	-10 ~ +52	-10 ~ +52
	Heat Min ~ Max	°C	-25 ~ +18	-25 ~ +18	-25 ~ +18	-25 ~ +18	-25 ~ +18	-25 ~ +18

Data is for reference. 1) EER and COP calculation is based in accordance to EN14511. 2) Piping diameter under 90 m for ultimate indoor unit / over 90 m for ultimate indoor unit (if the longest piping equivalent length exceeds 90 m, increase the sizes of the main tubes by 1 rank for gas tubes and liquid tubes). 3) If the following conditions are satisfied, the effective range is above 130% and below 200%: A. Obey the limited number of connectable indoor units. B. The lower limit of operating range for heating outdoor temperature is limited to -10 °C WB (standard -25 °C WB). C. Simultaneous operation is limited to less than 130% of connectable indoor units.

			42 HP	44 HP	46 HP	48 HP	50 HP	52 HP	
			U-10ME2E8	U-12ME2E8	U-14ME2E8	U-16ME2E8	U-10ME2E8	U-12ME2E8	
			U-16ME2E8	U-16ME2E8	U-16ME2E8	U-16ME2E8	U-12ME2E8	U-12ME2E8	
			U-16ME2E8	U-16ME2E8	U-16ME2E8	U-16ME2E8	U-12ME2E8	U-12ME2E8	
Outdoor unit	Power supply	Voltage	V	380 - 400 - 415	380 - 400 - 415	380 - 400 - 415	380 - 400 - 415	380 - 400 - 415	380 - 400 - 415
		Phase		Three phase	Three phase	Three phase	Three phase	Three phase	Three phase
		Frequency	Hz	50	50	50	50	50	50
	Cooling capacity	kW	118,0	124,0	130,0	135,0	140,0	145,0	
	EER ¹⁾	W/W	3,69	3,62	3,62	3,52	3,87	3,82	
	Current	A	52,80 - 50,20 - 48,40	56,00 - 53,20 - 51,30	59,90 - 56,90 - 54,90	63,40 - 60,20 - 58,10	59,10 - 56,20 - 54,20	62,10 - 59,00 - 56,80	
	Input power	kW	32,00	34,30	35,90	38,40	36,20	38,00	
	Heating capacity	kW	132,0	138,0	145,0	150,0	155,0	160,0	
	COP ¹⁾	W/W	4,49	4,50	4,46	4,42	4,65	4,66	
	Current	A	49,10 - 46,60 - 44,90	50,70 - 48,20 - 46,40	54,30 - 51,50 - 49,70	56,60 - 53,80 - 51,80	55,00 - 52,20 - 50,40	56,60 - 53,80 - 51,90	
	Input power	kW	29,40	30,70	32,50	33,90	33,30	34,30	
	Starting current	A	5,00	5,00	6,00	6,00	5,00	5,00	
	External static pressure (Max)	Pa	80	80	80	80	80	80	
	Air flow	m ³ /min	688	696	696	696	920	928	
Sound pressure	Normal	dB(A)	65,0	65,5	65,5	66,0	65,5	66,0	
	Silent mode	dB(A)	62,0	62,5	62,5	63,0	62,5	63,0	
Sound power	Normal mode	dB(A)	86,0	86,5	86,5	87,0	86,5	87,0	
Dimension / Net weight	HxWxD	mm / kg	1842x3250 x1000/840	1842x3660 x1000/900	1842x3660 x1000/945	1842x3660 x1000/945	1842x4490 x1000/1065	1842x4900 x1000/1125	
	Piping diameter ²⁾								
Piping diameter ²⁾	Liquid	Inch (mm)	3/4 (19,05)/ 7/8 (22,22)	3/4 (19,05)/ 7/8 (22,22)	3/4 (19,05)/ 7/8 (22,22)	3/4 (19,05)/ 7/8 (22,22)	3/4 (19,05)/ 7/8 (22,22)	3/4 (19,05)/ 7/8 (22,22)	
	Gas	Inch (mm)	1-1/2 (38,10)/ 1-5/8 (41,28)	1-1/2 (38,10)/ 1-5/8 (41,28)	1-1/2 (38,10)/ 1-5/8 (41,28)	1-1/2 (38,10)/ 1-5/8 (41,28)	1-1/2 (38,10)/ 1-5/8 (41,28)	1-1/2 (38,10)/ 1-5/8 (41,28)	
	Balance	Inch (mm)	1/4 (6,35)	1/4 (6,35)	1/4 (6,35)	1/4 (6,35)	1/4 (6,35)	1/4 (6,35)	
	Refrigerant (R410A) / CO ₂ Eq.	kg / T	22,20/51,9912	24,90/51,9912	24,90/51,9912	24,90/51,9912	30,50/63,6840	33,20/69,3216	
	Maximum allowable indoor / outdoor capacity ratio % ³⁾		50 - 130 (200)	50 - 130 (200)	50 - 130 (200)	50 - 130 (200)	50 - 130 (200)	50 - 130 (200)	
Operating range	Cool Min ~ Max	°C	-10 ~ +52	-10 ~ +52	-10 ~ +52	-10 ~ +52	-10 ~ +52	-10 ~ +52	
	Heat Min ~ Max	°C	-25 ~ +18	-25 ~ +18	-25 ~ +18	-25 ~ +18	-25 ~ +18	-25 ~ +18	

			54 HP	56 HP	58 HP	60 HP	62 HP	64 HP	
			U-10ME2E8	U-12ME2E8	U-10ME2E8	U-12ME2E8	U-14ME2E8	U-16ME2E8	
			U-12ME2E8	U-12ME2E8	U-16ME2E8	U-16ME2E8	U-16ME2E8	U-16ME2E8	
			U-16ME2E8	U-16ME2E8	U-16ME2E8	U-16ME2E8	U-16ME2E8	U-16ME2E8	
			U-16ME2E8	U-16ME2E8	U-16ME2E8	U-16ME2E8	U-16ME2E8	U-16ME2E8	
Outdoor unit	Power supply	Voltage	V	380 - 400 - 415	380 - 400 - 415	380 - 400 - 415	380 - 400 - 415	380 - 400 - 415	380 - 400 - 415
		Phase		Three phase	Three phase	Three phase	Three phase	Three phase	Three phase
		Frequency	Hz	50	50	50	50	50	50
	Cooling capacity	kW	151,0	156,0	162,0	168,0	174,0	180,0	
	EER ¹⁾	W/W	3,75	3,71	3,65	3,60	3,60	3,52	
	Current	A	66,60 - 63,20 - 60,90	68,80 - 65,30 - 63,00	73,30 - 69,70 - 67,10	77,10 - 73,30 - 70,60	79,80 - 75,80 - 73,00	84,60 - 80,30 - 77,40	
	Input power	kW	40,30	42,10	44,40	46,70	48,30	51,20	
	Heating capacity	kW	169,0	175,0	182,0	189,0	195,0	201,0	
	COP ¹⁾	W/W	4,56	4,56	4,47	4,47	4,45	4,42	
	Current	A	61,90 - 58,80 - 56,70	63,40 - 60,20 - 58,10	68,00 - 64,60 - 62,20	70,60 - 67,10 - 64,70	73,10 - 69,50 - 67,00	76,00 - 72,20 - 69,60	
	Input power	kW	37,10	38,40	40,70	42,30	43,80	45,50	
	Starting current	A	6,00	6,00	7,00	7,00	8,00	8,00	
	External static pressure (Max)	Pa	80	80	80	80	80	80	
	Air flow	m ³ /min	920	928	920	928	928	928	
Sound pressure	Normal	dB(A)	66,0	66,5	66,5	67,0	67,0	67,0	
	Silent mode	dB(A)	63,0	63,5	63,5	64,0	64,0	64,0	
Sound power	Normal mode	dB(A)	87,0	87,5	87,5	88,0	88,0	88,0	
Dimension / Net weight	HxWxD	mm / kg	1842x4490 x1000/1110	1842x4900 x1000/1170	1842x4490 x1000/1155	1842x4900 x1000/1215	1842x4900 x1000/1260	1842x4900 x1000/1260	
	Piping diameter ²⁾								
Piping diameter ²⁾	Liquid	Inch (mm)	3/4 (19,05)/ 7/8 (22,22)	3/4 (19,05)/ 7/8 (22,22)	3/4 (19,05)/ 7/8 (22,22)	3/4 (19,05)/ 7/8 (22,22)	3/4 (19,05)/ 7/8 (22,22)	3/4 (19,05)/ 7/8 (22,22)	
	Gas	Inch (mm)	1-1/2 (38,10)/ 1-5/8 (41,28)	1-1/2 (38,10)/ 1-5/8 (41,28)	1-1/2 (38,10)/ 1-5/8 (41,28)	1-1/2 (38,10)/ 1-5/8 (41,28)	1-5/8 (41,28)/ 1-3/4 (44,45)	1-5/8 (41,28)/ 1-3/4 (44,45)	
	Balance	Inch (mm)	1/4 (6,35)	1/4 (6,35)	1/4 (6,35)	1/4 (6,35)	1/4 (6,35)	1/4 (6,35)	
	Refrigerant (R410A) / CO ₂ Eq.	kg / T	30,50/63,6840	33,20/69,3216	30,50/63,6840	33,20/69,3216	33,20/69,3216	33,20/69,3216	
	Maximum allowable indoor / outdoor capacity ratio % ³⁾		50 - 130 (200)	50 - 130 (200)	50 - 130 (200)	50 - 130 (200)	50 - 130 (200)	50 - 130 (200)	
Operating range	Cool Min ~ Max	°C	-10 ~ +52	-10 ~ +52	-10 ~ +52	-10 ~ +52	-10 ~ +52	-10 ~ +52	
	Heat Min ~ Max	°C	-25 ~ +18	-25 ~ +18	-25 ~ +18	-25 ~ +18	-25 ~ +18	-25 ~ +18	

Data is for reference. 1) EER and COP calculation is based in accordance to EN14511. 2) Piping diameter under 90 m for ultimate indoor unit / over 90 m for ultimate indoor unit (if the longest piping equivalent length exceeds 90 m, increase the sizes of the main tubes by 1 rank for gas tubes and liquid tubes). 3) If the following conditions are satisfied, the effective range is above 130% and below 200%: A. Obey the limited number of connectable indoor units. B. The lower limit of operating range for heating outdoor temperature is limited to -10 °C WB (standard -25 °C WB). C. Simultaneous operation is limited to less than 130% of connectable indoor units.

2-Pipe ECOi EX ME2 Series space saving model combination from 22 to 80 HP

			22 HP	24 HP	26 HP	28 HP	30 HP	32 HP	34 HP
			U-10ME2E8	U-12ME2E8	U-10ME2E8	U-12ME2E8	U-14ME2E8	U-16ME2E8	U-14ME2E8
			U-12ME2E8	U-12ME2E8	U-16ME2E8	U-16ME2E8	U-16ME2E8	U-16ME2E8	U-20ME2E8
Outdoor unit	Voltage	V	380-400-415	380-400-415	380-400-415	380-400-415	380-400-415	380-400-415	380-400-415
	Phase		Three phase	Three phase	Three phase	Three phase	Three phase	Three phase	Three phase
	Frequency	Hz	50	50	50	50	50	50	50
Cooling capacity	kW		61,5	68,0	73,0	78,5	85,0	90,0	96,0
EER ¹⁾	W/W		4,13	3,93	3,80	3,69	3,68	3,52	3,56
SEER ²⁾			6,90	6,86	6,62	6,60	6,88	6,55	7,21
Current	A		24,30-23,10-22,30	28,00-26,60-25,60	31,70-30,10-29,00	34,80-33,10-31,90	38,60-36,60-35,30	42,30-40,20-38,70	44,10-41,90-40,40
Input power	kW		14,90	17,30	19,20	21,30	23,10	25,60	27,00
Heating capacity	kW		69,0	76,5	81,5	87,5	93,0	100,0	108,0
COP ¹⁾	W/W		4,76	4,69	4,55	4,56	4,48	4,42	4,17
SCOP ²⁾			4,53	4,78	4,16	4,29	4,13	4,09	4,14
Current	A		23,90-22,70-21,90	26,60-25,30-24,40	29,90-28,40-27,40	31,70-30,10-29,00	35,40-33,60-32,40	37,70-35,80-34,60	42,80-40,60-39,20
Input power	kW		14,50	16,30	17,90	19,20	21,20	22,60	25,90
Starting current	A		2,00	2,00	3,00	3,00	4,00	4,00	4,00
External static pressure (Max)	Pa		80	80	80	80	80	80	80
Air flow	m ³ /min		456	464	456	464	464	464	637
Sound pressure	Normal / Silent mode	dB(A)	61,0/58,0	62,0/59,0	62,5/59,5	63,5/60,5	63,5/60,5	64,0/61,0	63,0/60,0
Sound power	Normal mode	dB(A)	82,0	83,0	83,5	84,5	84,5	85,0	84,0
Dimension / Net weight	HxWxD	mm / kg	1842x2010 x1000/480	1842x2420 x1000/540	1842x2010 x1000/525	1842x2420 x1000/585	1842x2420 x1000/630	1842x2420 x1000/630	1842x2780 x1000/690
Piping diameter ³⁾	Liquid	Inch (mm)	5/8(15,88)/ 3/4(19,05)	5/8(15,88)/ 3/4(19,05)	3/4(19,05)/ 7/8(22,22)	3/4(19,05)/ 7/8(22,22)	3/4(19,05)/ 7/8(22,22)	3/4(19,05)/ 7/8(22,22)	3/4(19,05)/ 7/8(22,22)
	Gas	Inch (mm)	1-1/8(28,58)/ 1-1/4(31,75)	1-1/8(28,58)/ 1-1/4(31,75)	1-1/4(31,75)/ 1-1/2(38,10)	1-1/4(31,75)/ 1-1/2(38,10)	1-1/4(31,75)/ 1-1/2(38,10)	1-1/4(31,75)/ 1-1/2(38,10)	1-1/4(31,75)/ 1-1/2(38,10)
	Balance	Inch (mm)	1/4(6,35)	1/4(6,35)	1/4(6,35)	1/4(6,35)	1/4(6,35)	1/4(6,35)	1/4(6,35)
Refrigerant (R410A) / CO ₂ Eq.	kg / T		13,90/23,3856	16,60/34,6608	13,90/29,0232	16,60/34,6608	16,60/34,6608	16,60/34,6608	17,80/37,1664
Maximum allowable indoor / outdoor capacity ratio% ⁴⁾			50 ~ 130(200)	50 ~ 130(200)	50 ~ 130(200)	50 ~ 130(200)	50 ~ 130(200)	50 ~ 130(200)	50 ~ 130(200)
Operating range	Cool Min ~ Max	°C	-10 ~ +52	-10 ~ +52	-10 ~ +52	-10 ~ +52	-10 ~ +52	-10 ~ +52	-10 ~ +52
	Heat Min ~ Max	°C	-25 ~ +18	-25 ~ +18	-25 ~ +18	-25 ~ +18	-25 ~ +18	-25 ~ +18	-25 ~ +18

			36 HP	38 HP	40 HP	42 HP	44 HP	46 HP	48 HP
			U-16ME2E8	U-18ME2E8	U-20ME2E8	U-10ME2E8	U-12ME2E8	U-14ME2E8	U-16ME2E8
			U-20ME2E8	U-20ME2E8	U-20ME2E8	U-16ME2E8	U-16ME2E8	U-16ME2E8	U-16ME2E8
Outdoor unit	Voltage	V	380-400-415	380-400-415	380-400-415	380-400-415	380-400-415	380-400-415	380-400-415
	Phase		Three phase	Three phase	Three phase	Three phase	Three phase	Three phase	Three phase
	Frequency	Hz	50	50	50	50	50	50	50
Cooling capacity	kW		101,0	107,0	113,0	118,0	124,0	130,0	135,0
EER ¹⁾	W/W		3,42	3,42	3,34	3,69	3,62	3,62	3,52
SEER ²⁾			6,86	7,32	7,16	6,57	6,60	6,70	6,55
Current	A		47,70-45,30-43,70	50,60-48,10-46,30	54,10-51,40-49,50	52,80-50,20-48,40	56,00-53,20-51,30	59,90-56,90-54,90	63,40-60,20-58,10
Input power	kW		25,9	31,3	33,8	32,0	34,3	35,9	38,4
Heating capacity	kW		113,0	119,0	127,0	132,0	138,0	145,0	150,0
COP ¹⁾	W/W		4,14	4,13	3,92	4,49	4,50	4,46	4,42
SCOP ²⁾			4,06	4,14	4,13	4,11	4,21	4,12	4,09
Current	A		44,60-42,40-40,80	47,10-44,70-43,10	52,40-49,80-48,00	49,10-46,60-44,90	50,70-48,20-46,40	54,30-51,50-49,7	56,60-53,80-51,8
Input power	kW		27,30	28,80	32,40	29,40	30,70	32,50	33,90
Starting current	A		4,00	4,00	4,00	5,00	5,00	6,00	6,00
External static pressure (Max)	Pa		80	80	80	80	80	80	80
Air flow	m ³ /min		637	810	810	688	696	696	696
Sound pressure	Normal / Silent mode	dB(A)	63,5/60,5	62,5/59,5	63,0/60,0	65,0/62,0	65,5/62,5	65,5/62,5	66,0/63,0
Sound power	Normal mode	dB(A)	84,5	83,5	84,0	86,0	86,5	86,5	87,0
Dimension / Net weight	HxWxD	mm / kg	1842x2780 x1000/690	1842x3140 x1000/750	1842x3140 x1000/750	1842x3250 x1000/840	1842x3660 x1000/900	1842x3660 x1000/945	1842x3660 x1000/945
Piping diameter ³⁾	Liquid	Inch (mm)	3/4(19,05)/ 7/8(22,22)	3/4(19,05)/ 7/8(22,22)	3/4(19,05)/ 7/8(22,22)	3/4(19,05)/ 7/8(22,22)	3/4(19,05)/ 7/8(22,22)	3/4(19,05)/ 7/8(22,22)	3/4(19,05)/ 7/8(22,22)
	Gas	Inch (mm)	1-1/2(38,10)/ 1-5/8(41,28)	1-1/2(38,10)/ 1-5/8(41,28)	1-1/2(38,10)/ 1-5/8(41,28)	1-1/2(38,10)/ 1-5/8(41,28)	1-1/2(38,10)/ 1-5/8(41,28)	1-1/2(38,10)/ 1-5/8(41,28)	1-1/2(38,10)/ 1-5/8(41,28)
	Balance	Inch (mm)	1/4(6,35)	1/4(6,35)	1/4(6,35)	1/4(6,35)	1/4(6,35)	1/4(6,35)	1/4(6,35)
Refrigerant (R410A) / CO ₂ Eq.	kg / T		17,80/37,1664	19,00/39,672	19,00/39,672	22,20/46,3536	24,90/51,9912	24,90/51,9912	24,90/51,9912
Maximum allowable indoor / outdoor capacity ratio% ⁴⁾			50 ~ 130(200)	50 ~ 130(200)	50 ~ 130(200)	50 ~ 130(200)	50 ~ 130(200)	50 ~ 130(200)	50 ~ 130(200)
Operating range	Cool Min ~ Max	°C	-10 ~ +52	-10 ~ +52	-10 ~ +52	-10 ~ +52	-10 ~ +52	-10 ~ +52	-10 ~ +52
	Heat Min ~ Max	°C	-25 ~ +18	-25 ~ +18	-25 ~ +18	-25 ~ +18	-25 ~ +18	-25 ~ +18	-25 ~ +18

1) EER and COP calculation is based in accordance to EN14511. 2) SEER / SCOP is calculated based on the seasonal space cooling / heating efficiency "η" values of the COMMISSION REGULATION (EU) 2016/2281. SEER, SCOP = (η + Correction) × PE.F. 3) Piping diameter under 90 m for ultimate indoor unit / over 90 m for ultimate indoor unit (if the longest piping equivalent length exceeds 90 m, increase the sizes of the main tubes by 1 rank for gas tubes and liquid tubes). 4) If the following conditions are satisfied, the effective range is above 130% and below 200%: A. Obey the limited number of connectable indoor units. B. The lower limit of operating range for heating outdoor temperature is limited to -10 °C WB [standard -25 °C WB]. C. Simultaneous operation is limited to less than 130% of connectable indoor units.

			50 HP	52 HP	54 HP	56 HP	58 HP	60 HP	62 HP	64 HP	
			U-14ME2E8	U-16ME2E8	U-14ME2E8	U-16ME2E8	U-18ME2E8	U-20ME2E8	U-14ME2E8	U-16ME2E8	
			U-16ME2E8	U-16ME2E8	U-20ME2E8	U-20ME2E8	U-20ME2E8	U-20ME2E8	U-16ME2E8	U-16ME2E8	
			U-20ME2E8	U-20ME2E8	U-20ME2E8	U-20ME2E8	U-20ME2E8	U-20ME2E8	U-16ME2E8	U-16ME2E8	
										U-16ME2E8	U-16ME2E8
Outdoor unit	Voltage	V	380-400-415	380-400-415	380-400-415	380-400-415	380-400-415	380-400-415	380-400-415	380-400-415	380-400-415
	Phase		Three phase	Three phase	Three phase	Three phase	Three phase	Three phase	Three phase	Three phase	Three phase
	Frequency	Hz	50	50	50	50	50	50	50	50	50
Cooling capacity		kW	140,0	145,0	151,0	156,0	162,0	168,0	174,0	180,0	180,0
EER ¹⁾		W/W	3,55	3,46	3,49	3,41	3,40	3,35	3,60	3,52	3,52
SEER ²⁾			6,96	6,72	7,16	6,92	7,30	7,16	6,68	6,55	6,55
Current		A	64,40-61,10-58,90	68,50-65,00-62,70	70,00-66,50-64,10	74,00-70,30-67,80	76,90-73,10-70,40	80,10-76,10-73,40	79,80-75,80-73,00	84,60-80,30-77,40	84,60-80,30-77,40
Input power		kW	39,40	41,90	43,30	45,80	47,60	50,10	48,30	51,20	51,20
Heating capacity		kW	155,0	160,0	169,0	175,0	182,0	189,0	195,0	201,0	201,0
COP ¹⁾		W/W	4,29	4,27	4,11	4,08	4,06	3,94	4,45	4,42	4,42
SCOP ²⁾			4,08	4,05	4,13	4,07	4,13	4,13	4,11	4,09	4,09
Current		A	59,60-56,60-54,60	61,90-58,80-56,70	67,10-63,80-61,50	70,10-66,60-64,20	73,20-69,50-67,00	77,60-73,70-71,00	73,10-69,50-67,00	76,00-72,20-69,6	76,00-72,20-69,6
Input power		kW	36,10	37,50	41,10	42,90	44,80	48,00	43,80	45,50	45,50
Starting current		A	6,00	6,00	6,00	6,00	6,00	6,00	8,00	8,00	8,00
External static pressure (Max)		Pa	80	80	80	80	80	80	80	80	80
Air flow		m ³ /min	869	869	1042	1042	1215	1215	928	928	928
Sound pressure	Normal / Silent mode	dB(A)	65,5/62,5	65,5/62,5	65,0/62,0	65,5/62,5	64,5/61,5	65,0/62,0	67,0/64,0	67,0/64,0	67,0/64,0
Sound power	Normal mode	dB(A)	86,5	86,5	86,0	86,5	85,5	86,0	88,0	88,0	88,0
Dimension / Net weight	H x W x D	mm / kg	1842 x 4020 x 1000/1005	1842 x 4020 x 1000/1005	1842 x 4380 x 1000/1065	1842 x 4380 x 1000/1065	1842 x 4740 x 1000/1125	1842 x 4740 x 1000/1125	1842 x 4900 x 1000/1260	1842 x 4900 x 1000/1260	1842 x 4900 x 1000/1260
	Liquid	Inch (mm)	3/4(19,05)/7/8(22,22)	3/4(19,05)/7/8(22,22)	3/4(19,05)/7/8(22,22)	3/4(19,05)/7/8(22,22)	3/4(19,05)/7/8(22,22)	3/4(19,05)/7/8(22,22)	3/4(19,05)/7/8(22,22)	3/4(19,05)/7/8(22,22)	3/4(19,05)/7/8(22,22)
Piping diameter ³⁾	Gas	Inch (mm)	1-1/2(38,10)/1-5/8(41,28)	1-1/2(38,10)/1-5/8(41,28)	1-1/2(38,10)/1-5/8(41,28)	1-1/2(38,10)/1-5/8(41,28)	1-1/2(38,10)/1-5/8(41,28)	1-1/2(38,10)/1-5/8(41,28)	1-5/8(41,28)/1-3/4(44,45)	1-5/8(41,28)/1-3/4(44,45)	1-5/8(41,28)/1-3/4(44,45)
	Balance	Inch (mm)	1/4(6,35)	1/4(6,35)	1/4(6,35)	1/4(6,35)	1/4(6,35)	1/4(6,35)	1/4(6,35)	1/4(6,35)	1/4(6,35)
	Refrigerant (R410A) / CO ₂ Eq.	kg / T	26,10/54,4968	26,10/54,4968	27,30/57,0024	27,30/57,0024	28,50/59,508	28,50/59,508	33,20/69,3216	33,20/69,3216	33,20/69,3216
Maximum allowable indoor / outdoor capacity ratio% ⁴⁾			50 ~ 130(200)	50 ~ 130(200)	50 ~ 130(200)	50 ~ 130(200)	50 ~ 130(200)	50 ~ 130(200)	50 ~ 130(200)	50 ~ 130(200)	50 ~ 130(200)
Operating range	Cool Min ~ Max	°C	-10 ~ +52	-10 ~ +52	-10 ~ +52	-10 ~ +52	-10 ~ +52	-10 ~ +52	-10 ~ +52	-10 ~ +52	-10 ~ +52
	Heat Min ~ Max	°C	-25 ~ +18	-25 ~ +18	-25 ~ +18	-25 ~ +18	-25 ~ +18	-25 ~ +18	-25 ~ +18	-25 ~ +18	-25 ~ +18

			66 HP	68 HP	70 HP	72 HP	74 HP	76 HP	78 HP	80 HP
			U-10ME2E8	U-12ME2E8	U-10ME2E8	U-16ME2E8	U-16ME2E8	U-16ME2E8	U-18ME2E8	U-20ME2E8
			U-16ME2E8	U-16ME2E8	U-20ME2E8	U-16ME2E8	U-18ME2E8	U-20ME2E8	U-20ME2E8	U-20ME2E8
			U-20ME2E8	U-20ME2E8	U-20ME2E8	U-20ME2E8	U-20ME2E8	U-20ME2E8	U-20ME2E8	U-20ME2E8
			U-20ME2E8	U-20ME2E8	U-20ME2E8	U-20ME2E8	U-20ME2E8	U-20ME2E8	U-20ME2E8	U-20ME2E8
Outdoor unit	Voltage	V	380-400-415	380-400-415	380-400-415	380-400-415	380-400-415	380-400-415	380-400-415	380-400-415
	Phase		Three phase	Three phase	Three phase	Three phase	Three phase	Three phase	Three phase	Three phase
	Frequency	Hz	50	50	50	50	50	50	50	50
Cooling capacity		kW	185,0	190,0	196,0	202,0	208,0	213,0	219,0	224,0
EER ¹⁾		W/W	3,52	3,49	3,47	3,42	3,42	3,39	3,38	3,35
SEER ²⁾			6,92	6,91	7,09	6,86	7,03	7,01	7,18	7,16
Current		A	85,00-80,80-77,80	88,10-83,70-80,70	91,30-86,80-83,60	95,40-90,60-87,30	98,30-93,40-90,00	101,70-96,60-93,10	103,50-98,30-94,70	106,80-101,50-97,80
Input power		kW	52,60	54,50	56,50	59,00	60,80	62,90	64,70	66,80
Heating capacity		kW	207,0	213,0	219,0	226,0	233,0	239,0	245,0	252,0
COP ¹⁾		W/W	4,16	4,18	4,05	4,14	4,12	4,03	4,03	3,94
SCOP ²⁾			4,11	4,17	4,13	4,06	4,12	4,07	4,13	4,13
Current		A	81,20-77,10-74,30	83,30-79,20-76,30	87,40-83,10-80,10	89,20-84,70-81,70	92,30-87,70-84,50	96,90-92,00-88,70	98,30-93,40-90,00	103,40-98,30-94,70
Input power		kW	49,70	51,00	54,10	54,60	56,50	59,30	60,80	64,00
Starting current		A	7,00	7,00	7,00	8,00	8,00	8,00	8,00	8,00
External static pressure (Max)		Pa	80	80	80	80	80	80	80	80
Air flow		m ³ /min	1266	1274	1439	1274	1447	1447	1620	1620
Sound pressure	Normal / Silent mode	dB(A)	66,0/63,0	66,5/63,5	65,5/62,5	66,5/63,5	66,5/63,5	66,5/63,5	66,0/63,0	66,0/63,0
Sound power	Normal mode	dB(A)	87,0	87,5	86,5	87,5	87,5	87,5	87,0	87,0
Dimension / Net weight	H x W x D	mm / kg	1842 x 5210 x 1000/1275	1842 x 5620 x 1000/1335	1842 x 5570 x 1000/1335	1842 x 5620 x 1000/1380	1842 x 5980 x 1000/1440	1842 x 5980 x 1000/1440	1842 x 6340 x 1000/1500	1842 x 6340 x 1000/1500
	Liquid	Inch (mm)	3/4(19,05)/7/8(22,22)	7/8(22,22)/1(25,04)	7/8(22,22)/1(25,04)	7/8(22,22)/1(25,04)	7/8(22,22)/1(25,04)	7/8(22,22)/1(25,04)	7/8(22,22)/1(25,04)	7/8(22,22)/1(25,04)
Piping diameter ³⁾	Gas	Inch (mm)	1-5/8(41,28)/1-3/4(44,45)	1-5/8(41,28)/1-3/4(44,45)	1-5/8(41,28)/1-3/4(44,45)	1-3/4(44,45)/2(50,80)	1-3/4(44,45)/2(50,80)	1-3/4(44,45)/2(50,80)	1-3/4(44,45)/2(50,80)	1-3/4(44,45)/2(50,80)
	Balance	Inch (mm)	1/4(6,35)	1/4(6,35)	1/4(6,35)	1/4(6,35)	1/4(6,35)	1/4(6,35)	1/4(6,35)	1/4(6,35)
	Refrigerant (R410A) / CO ₂ Eq.	kg / T	32,90/68,6952	35,60/74,3328	34,10/19,836	35,80/68,6952	36,80/76,8384	36,80/76,8384	38,00/79,344	38,00/79,344
Maximum allowable indoor / outdoor capacity ratio% ⁴⁾			50 ~ 130(200)	50 ~ 130(200)	50 ~ 130(200)	50 ~ 130(200)	50 ~ 130(200)	50 ~ 130(200)	50 ~ 130(200)	50 ~ 130(200)
Operating range	Cool Min ~ Max	°C	-10 ~ +52	-10 ~ +52	-10 ~ +52	-10 ~ +52	-10 ~ +52	-10 ~ +52	-10 ~ +52	-10 ~ +52
	Heat Min ~ Max	°C	-25 ~ +18	-25 ~ +18	-25 ~ +18	-25 ~ +18	-25 ~ +18	-25 ~ +18	-25 ~ +18	-25 ~ +18

1) EER and COP calculation is based in accordance to EN14511. 2) SEER / SCOP is calculated based on the seasonal space cooling / heating efficiency "η" values of the COMMISSION REGULATION (EU) 2016/2281. SEER, SCOP = (η + Correction) × PEF. 3) Piping diameter under 90 m for ultimate indoor unit / over 90 m for ultimate indoor unit (if the longest piping equivalent length exceeds 90 m, increase the sizes of the main tubes by 1 rank for gas tubes and liquid tubes). 4) If the following conditions are satisfied, the effective range is above 130% and below 200%: A. Obey the limited number of connectable indoor units. B. The lower limit of operating range for heating outdoor temperature is limited to -10 °C WB (standard -25 °C WB). C. Simultaneous operation is limited to less than 130% of connectable indoor units.

3-Pipe ECOi EX MF3 Series



Simultaneous heating and cooling VRF system.
 The Panasonic 3-Pipe ECOi EX MF3 Series offers the best solution for the most discerning customers and demanding installations.

Simultaneous heating and cooling VRF System

The Panasonic 3-Pipe ECOi EX MF3 Series offers the ideal solution to meet customer's demands.

Upgraded energy efficiency utilized ECOi EX technology.

- SEER / SCOP improved in full capacities from 8 to 16 HP
- SEER / SCOP follows LOT21 (January 2018)
- Eurovent certified EER / COP

Design flexibility.

- High reliability even under extreme temperature conditions
- Connection of up to 52 indoor units
- Slim heat recovery box with just 200 mm height
- Farthest piping length between indoor and outdoor units: 200 m

Excellent seasonal energy saving.

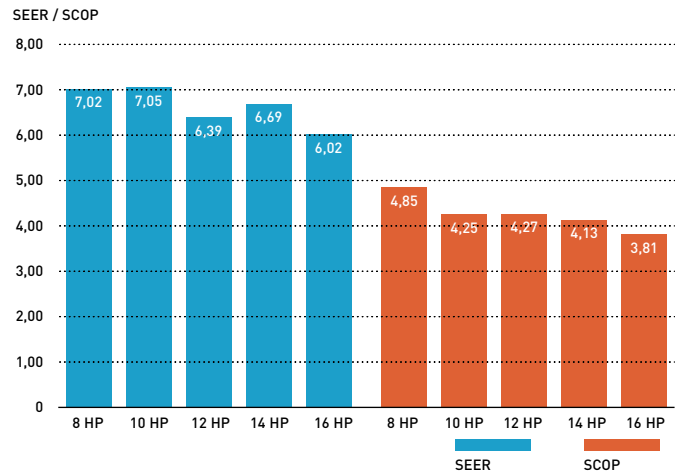

Extended design operation conditions

Cooling design operation conditions: The cooling operating range has been extended to -10 °C ~ 52 °C by changing the outdoor fan to an Inverter type.

Heating design operation conditions: Stable heating operation even with an outside air temperature of -20 °C. The heating operating range has been extended to -20 °C by use of a compressor with a high-pressure vessel.

Cooling design operation conditions.

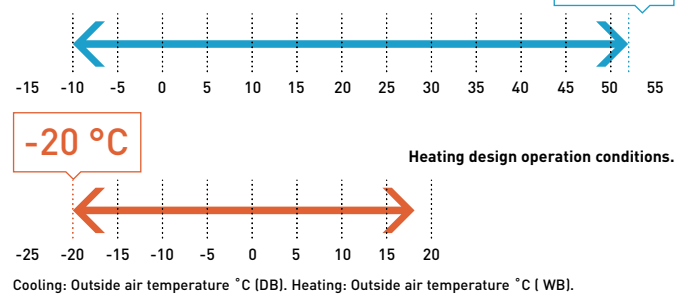

Wide temperature setting range

Wired remote controller heating temperature setting range is 16 to 30 °C as standard.

Increased maximum number of connectable indoor units

Maximum 48 HP with 52 indoor units can be set up according to user needs. Connectable indoor / outdoor unit capacity ratio up to 150%.

System (HP)	8	10	12	14	16	18	20	22	24	26	28	30	32	34	36	38	40	42	44	46	48
Connectable indoor units*: 150%	19	24	29	34	39	43	48	52					52								

*Depending on indoor units types. Please check service manuals.

Power suppression control for energy saving (demand control) ¹⁾

The 3-Pipe ECOi EX MF3 Series has a built-in demand function which uses the Inverter characteristics. With this demand function, the power consumption can be set in three steps, and operation ²⁾ at optimum performance is performed according to the setting and the power consumption. This function is useful to reduce the annual power consumption and to save electricity costs while maintaining comfort.

1) An outdoor Seri-Para I/O unit is required for demand input.

2) Setting is possible as 0% or in the range from 40 to 100% (in steps of 5%). At the time of shipping, setting has been done to the three steps of 0%, 70%, and 100%.

Slim 3-Pipe control box kit / Multiple connection type

Heat recovery Box to connect multiple indoor units with just one box, 4, 6 and up to 8 indoor units or groups.

The height is only 200 mm, which is especially advantageous in hotel applications, where space for connecting several boxes is limited.

Individual control of multiple indoor units with solenoid valve kits.

- Any design and layout can be used in a single system.
- Cooling operation is possible with an outdoor temperature of -10 °C.

System structure.

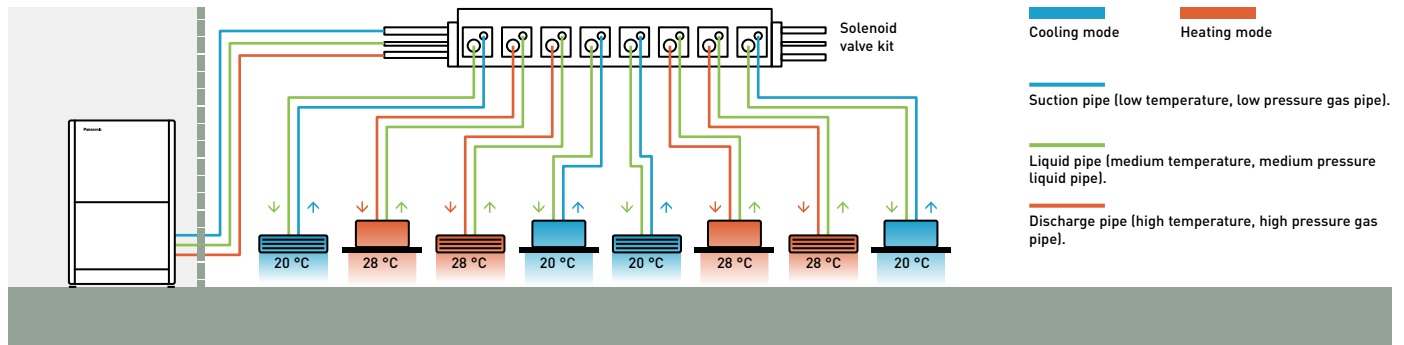

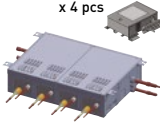
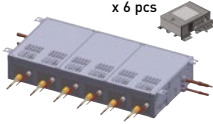
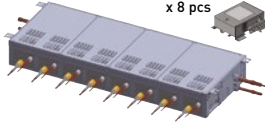
				
	1 port	4 port	6 port	8 port
56 type	CZ-P56HR3	CZ-P456HR3	CZ-P656HR3	CZ-P856HR3
160 type	CZ-P160HR3	CZ-P4160HR3	—	—

Solenoid valve kit / wiring work

Single connection type.

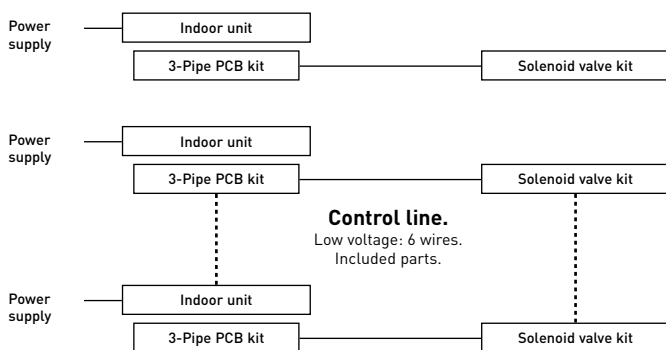

Multiple connection type.

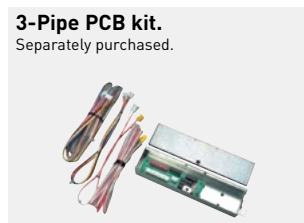
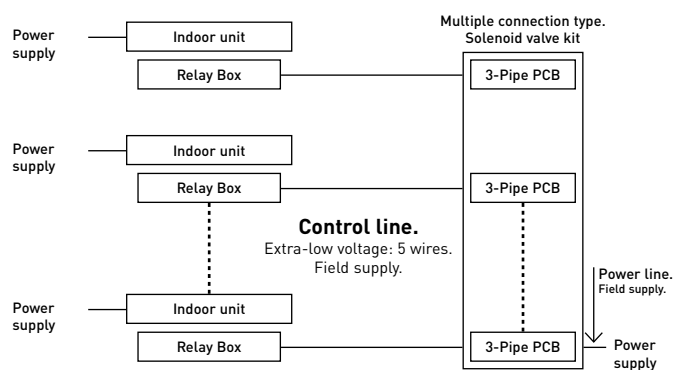

3-Pipe ECOi EX MF3 Series superior flexibility

Increased piping lengths and design flexibility

Adaptable to various building types and sizes. Actual piping length: 200 m. Maximum piping length: 500 m.

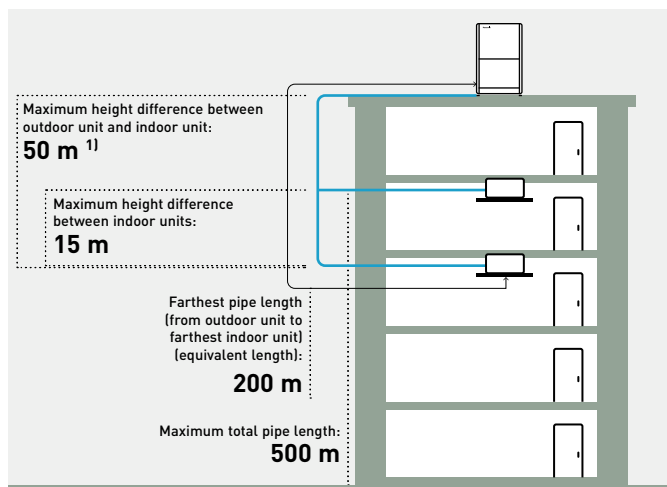

1) 40 m if the outdoor unit is below the indoor unit.

Up to 40 m piping after first branch

Up to 52 units can be connected to one system. Flexible piping layout makes it easier to design systems for locations such as train stations, airports, schools and hospitals.

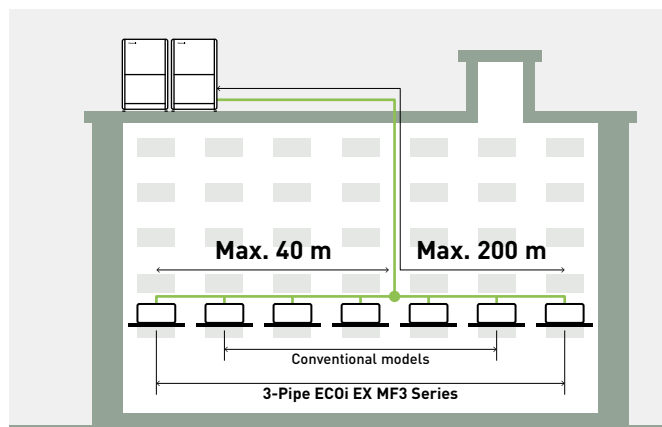

Excellent cost saving and smaller piping size

By using R410A with low pressure loss, pipe sizes for discharge, suction and liquid are all reduced. This makes it possible to aim for reduced piping space, improved workability at the site, and reduction of the piping material costs.

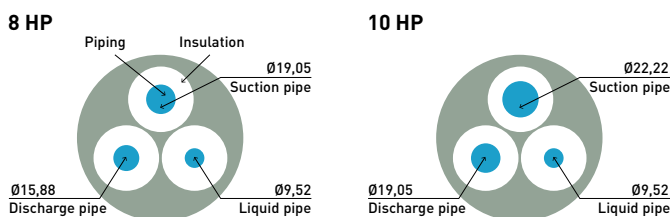

High external static pressure on condensers

With an efficient fan shape, fan guard, motor, and casing, the models can be custom-installed on-site to provide up to 80 Pa of external static pressure.

An air discharge duct prevents air flow short-circuiting, allowing outdoor units to be installed on every floor of a building.



Fan.

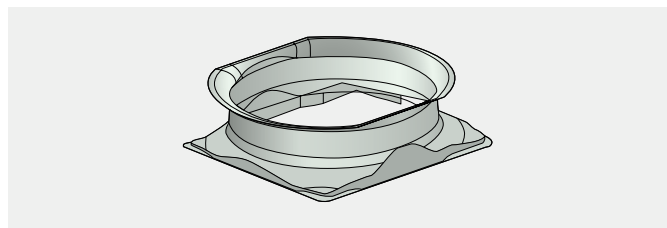

Bell-mouth casing.

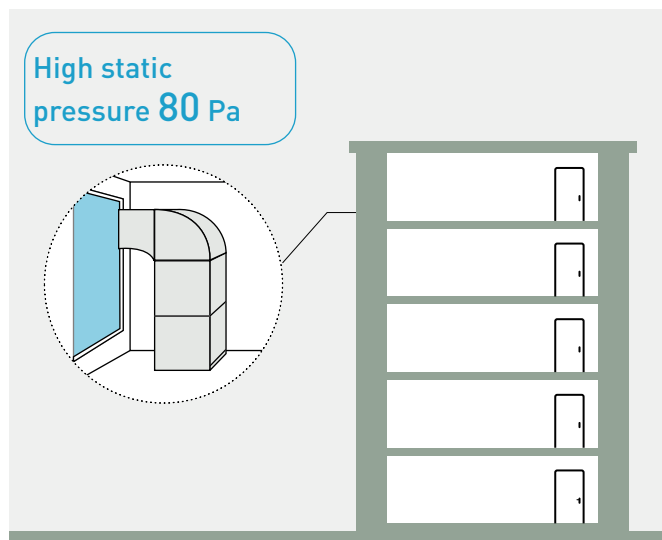

3-Pipe ECOi EX MF3 Series piping design

Select the installation location so that the length and size of refrigerant tubing are within the allowable range shown in the figure below.

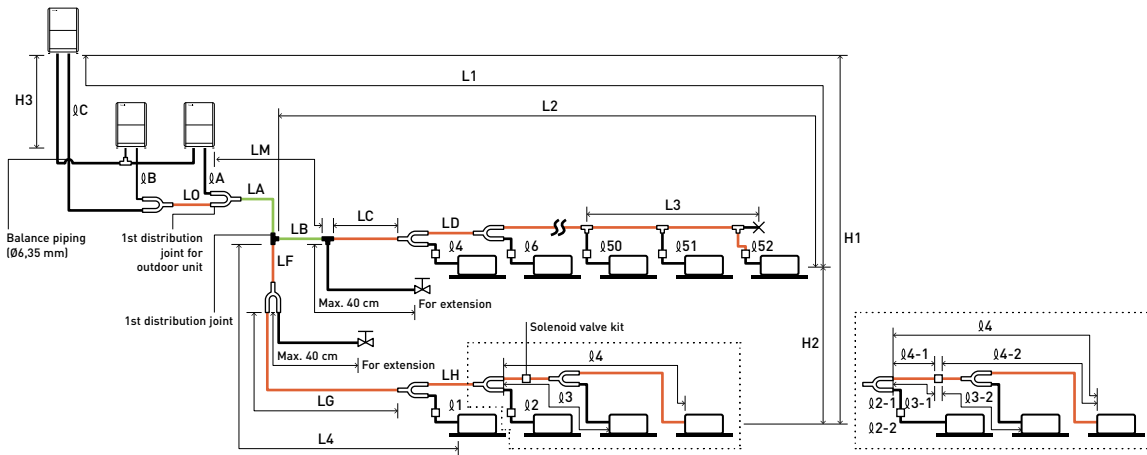

The outdoor connection main piping (LO portion) is determined by the total capacity of the outdoor units that are connected to the tube ends.
 Note: Be sure to use special R410A distribution joints (CZ: optional parts) for outdoor unit connections and piping branches.

R410A distribution joint.
 CZ-P680PJ2BM (for outdoor unit)
 CZ-P1350PJ2BM (for outdoor unit)
 CZ-P224BH2BM (for indoor unit)
 CZ-P680BH2BM (for indoor unit)
 CZ-P1350BH2BM (for indoor unit)

Main piping length (maximum piping size) $LM = LA + LB \dots$

Main distribution tubes LC - LH are selected according to the capacity after the distribution joint.

Sizes of indoor unit connection piping $\varnothing 1 - \varnothing 52$ are determined by the connection piping sizes on the indoor units.

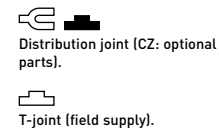

Ranges that apply to refrigerant piping lengths and to differences in installation heights

Items	Mark	Contents	Length (m)
Allowable piping length	L1	Maximum piping length	Actual length $\leq 200^{1)}$ Equivalent length $\leq 210^{1)}$
	ΔL (L2-L4)	Difference between maximum length and minimum length from the 1st distribution joint	$\leq 50^{2)}$
	LM	Maximum length of main piping (at maximum size) * Even after 1st distribution joint, LM is allowed if at maximum piping length.	— ³⁾
	$\varnothing 1, \varnothing 2 - \varnothing 52$	Maximum length of each distribution tube	$\leq 50^{4)}$
	$L1 + \varnothing 1 + \varnothing 2 - \varnothing 51 + \varnothing A + \varnothing B + LF + LG + LH$	Total maximum piping length including length of each distribution tube (only liquid piping)	≤ 500
Allowable elevation difference	$\varnothing A, \varnothing B + LO, \varnothing C + LO$	Maximum piping length from outdoor's 1st distribution joint to each outdoor unit	≤ 10
	$\varnothing 1-2, \varnothing 2-2 - \varnothing 52-2$	Maximum length between solenoid valve kit and indoor unit	≤ 30
	H1	When outdoor unit is installed higher than indoor unit	≤ 50
	H2	When outdoor unit is installed lower than indoor unit	≤ 40
Allowable length of joint piping	H2	Maximum difference between indoor units	$\leq 15^{5)}$
	H3	Maximum difference between outdoor units	≤ 4
Allowable length of joint piping	L3	T-joint piping (field-supply); Maximum piping length between the first T-joint and solidly welded-shut end point	≤ 2

L = Length, H = Height

1) If the longest piping length (L1) exceeds 90 m (equivalent length), increase the sizes of the main pipes (LM) by 1 rank for suction pipes, discharge pipes and liquid pipes. Use a field supply reducer. Select the pipe size from the table of main piping sizes (Table 3) and from the table of refrigerant piping sizes (Table 8). 2) If the longest main piping length (LM) exceeds 50 m, increase the main piping size at the portion before 50 m by 1 rank for the suction pipes and discharge pipes. Use a field supply reducer. Determine the length less than the limitation of allowable maximum piping length. For the portion that exceeds 50 m, set based on the main piping size (LA) listed in Table 3. 3) If the piping length marked "L" (L2-L4) exceeds 40 m, increase the piping size at the portion after the 1st distribution joint by 1 rank for the liquid pipe, suction pipe and discharge pipe. Refer to the Technical Data for the details. 4) If any of the piping length exceeds 30 m, increase the size of the suction pipes, discharge pipes and liquid pipes by 1 rank.
 * The outdoor connection main piping (LO portion) is determined by the total capacity of the outdoor units that are connected to the pipe ends.

System limitations.

Maximum number allowable connected outdoor units	3
Maximum capacity allowable connected outdoor units	135 kW (48 HP)
Maximum connectable indoor units	52
Maximum allowable indoor / outdoor capacity ratio	50-150%

1) In the case of 24 HP (type 68 kW) or smaller units, the number is limited by the total capacity of the connected indoor units.
 2) Up to 3 units can be connected if the system has been extended.
 3) It is strongly recommended that you choose the unit so the load can become between 50 and 130%.

Additional refrigerant charge.

Liquid piping size (Inch (mm))	1/4 (6,35)	3/8 (9,52)	1/2 (12,70)	5/8 (15,88)	3/4 (19,05)	7/8 (22,22)
Amount of refrigerant charge (g/m)	26	56	128	185	259	366

Necessary amount of additional refrigerant charge per meter, according to discharge piping size.

Discharge piping size	Inch (mm)	1/2 (12,70)	5/8 (15,88)	3/4 (19,05)	7/8 (22,22)	1 (25,40)	1-1/8 (28,58)	1-1/4 (31,75)	1-1/2 (38,10)
Additional amount	g/m	12	21	31	41	55	71	89	126

Refrigerant piping.

Piping size (mm)				Material Temper - 0				Material Temper - 1/2 H, H			
Ø6,35	t 0,8	Ø12,70	t 0,8	Ø19,05	t 1,2	Ø22,22	t 1,0	Ø28,58	t 1,0	Ø38,10	t 1,15
Ø9,52	t 0,8	Ø15,88	t 1,0			Ø25,40	t 1,0	Ø31,75	t 1,1	Ø41,28	t 1,20

* When bending the tubes, use a bending radius that is at least 4 times the outer diameter of the tubes. In addition, take sufficient care to avoid crushing or damaging the tubes when bending them.

3-Pipe ECOi EX MF3 Series

Simultaneous heating and cooling operation with heat recovery type.

The 3-Pipe ECOi EX MF3 Series is one of the most advanced VRF systems.

Not only highly efficient performance for simultaneous heating and cooling, but also sophisticated installation and maintenance capability.

4,85
SCOP



			8 HP	10 HP	12 HP	14 HP	16 HP
Outdoor unit			U-8MF3E8	U-10MF3E8	U-12MF3E8	U-14MF3E8	U-16MF3E8
Power supply	Voltage	V	380-400-415	380-400-415	380-400-415	380-400-415	380-400-415
	Phase		Three phase	Three phase	Three phase	Three phase	Three phase
	Frequency	Hz	50	50	50	50	50
Cooling capacity		kW	22,4	28,0	33,5	40,0	45,0
EER ¹⁾		W/W	5,11	4,72	3,91	3,70	3,49
Current		A	7,16 - 6,80 - 6,55	9,90 - 9,41 - 9,07	3,19 - 13,20 - 12,70	18,20 - 17,30 - 16,70	21,30 - 20,20 - 19,50
Input power		kW	4,38	5,93	8,57	10,80	12,90
Heating capacity		kW	25,0	31,5	37,5	45,0	50,0
COP ¹⁾		W/W	5,25	5,17	4,51	4,21	4,17
Current		A	7,78 - 7,39 - 7,12	10,20 - 9,66 - 9,31	13,40 - 12,80 - 12,30	18,10 - 17,20 - 16,50	20,00 - 19,00 - 18,30
Input power		kW	4,76	6,09	8,32	10,70	12,00
Starting current		A	1,00	1,00	1,00	2,00	2,00
External static pressure (Max)		Pa	80	80	80	80	80
Air flow		m ³ /min	210	220	232	232	232
Sound pressure	Normal mode	dB(A)	54,0	57,0	60,0	61,0	62,0
	Silent mode 1 / 2	dB(A)	51,0/49,0	54,0/52,0	57,0/55,0	58,0/56,0	59,0/57,0
Sound power	Normal mode	dB(A)	76,0	78,0	81,0	82,0	82,0
Dimension	HxWxD	mm	1842x1180x1000	1842x1180x1000	1842x1180x1000	1842x1180x1000	1842x1180x1000
Net weight		kg	261	262	286	334	334
Piping diameter ²⁾	Liquid	Inch (mm)	3/8(9,52)/1/2(12,70)	3/8(9,52)/1/2(12,70)	1/2(12,70)/5/8(15,88)	1/2(12,70)/5/8(15,88)	1/2(12,70)/5/8(15,88)
	Discharge	Inch (mm)	5/8(15,88)/3/4(19,05)	3/4(19,05)/7/8(22,22)	3/4(19,05)/7/8(22,22)	7/8(22,22)/1(25,40)	7/8(22,22)/1(25,40)
	Suction	Inch (mm)	3/4(19,05)/7/8(22,22)	7/8(22,22)/1(25,40)	1(25,40)/1-1/8(28,58)	1(25,40)/1-1/8(28,58)	1-1/8(28,58)/1-1/4(31,75)
	Balance	Inch (mm)	1/4(6,35)	1/4(6,35)	1/4(6,35)	1/4(6,35)	1/4(6,35)
Refrigerant (R410A) / CO ₂ Eq.		kg / T	6,80/14,1984	6,80/14,1984	8,30/17,3304	8,30/17,3304	8,30/17,3304
Maximum allowable indoor / outdoor capacity ratio %		%	50 ~ 150	50 ~ 150	50 ~ 150	50 ~ 150	50 ~ 150
Operating range	Cool Min ~ Max	°C	-10 ~ +52	-10 ~ +52	-10 ~ +52	-10 ~ +52	-10 ~ +52
	Heat Min ~ Max	°C	-20 ~ +18	-20 ~ +18	-20 ~ +18	-20 ~ +18	-20 ~ +18
	Simultaneous op.	°C	-10 ~ +24	-10 ~ +24	-10 ~ +24	-10 ~ +24	-10 ~ +24

ErP data ³⁾						
SEER ⁴⁾		7,02	7,05	6,39	6,69	6,02
$\eta_{s,c}$		277,7%	278,9%	252,7%	264,4%	237,7%
SCOP ⁴⁾		4,85	4,25	4,27	4,13	3,81
$\eta_{s,h}$		190,9%	166,8%	167,8%	162,1%	149,3%

1) EER and COP calculation is based in accordance to EN14511. 2) Piping diameter under 90 m for ultimate indoor unit / over 90 m for ultimate outdoor unit (if the longest piping equivalent length exceeds 90 m, increase the sizes of the main tubes by 1 rank for gas tubes and liquid tubes). 3) SEER / SCOP and $\eta_{s,c}$ / $\eta_{s,h}$ are in accordance with ErP test data for F2 type variable static pressure hide-away indoor units. Eurovent certified. 4) SEER / SCOP is calculated based on the seasonal space cooling / heating efficiency η values of the COMMISSION REGULATION (EU) 2016/2281. SEER, SCOP = $(\eta + \text{Correction}) \times \text{PEF}$.

Solenoid valve kit	
KIT-P56HR3	3-Pipe control solenoid valve kit (up to 5,6 kW)
CZ-P56HR3	Solenoid valve kit (up to 5,6 kW)
CZ-CAPE2	3-Pipe control PCB
KIT-P160HR3	3-Pipe control solenoid valve kit (from 5,6 to 16,0 kW)
CZ-P160HR3	Solenoid valve kit (from 5,6 kW to 16,0 kW)
CZ-CAPE2	3-Pipe control PCB
CZ-CAPEK2 ⁵⁾	3-Pipe control PCB for wall-mounted

3-Pipe control box kit	
CZ-P456HR3	4 ports 3 pipe box (up to 5,6 kW per port)
CZ-P656HR3	6 ports 3 pipe box (up to 5,6 kW per port)
CZ-P856HR3	8 ports 3 pipe box (up to 5,6 kW per port)
CZ-P4160HR3	4 ports 3 pipe box (up to 16,0 kW per port)

5) Available for S-45/56/73/106MK2E5B.

- Achieving SCOP 4,85 top class in the industry (LOT21 Seasonal heating efficiency value for 8 HP outdoor unit)
- Simultaneous cooling and heating operation with up to 39 indoor units
- Slim heat recovery boxes with just 200 mm height fit with the ceiling space limited in hotel applications

Technical focus

- High SEER / SCOP at full Load capacity (follows LOT21)
- Eurovent certified EER / COP
- Standardisation of outdoor unit to one compact casing size
- Connection of up to 52 indoor units
- High external static pressure 80 Pa with an efficient fan shape, fan guard, motor, and casing
- Silent outdoor unit operation: Minimum 54 dB(A) for 8 HP
- Bluefin coil coating as standard



3-Pipe ECOi EX MF3 Series combination from 18 to 48 HP

HP			18 HP	20 HP	22 HP	24 HP	26 HP	28 HP	30 HP	32 HP
Outdoor unit			U-8MF3E8	U-8MF3E8	U-10MF3E8	U-12MF3E8	U-10MF3E8	U-12MF3E8	U-14MF3E8	U-16MF3E8
			U-10MF3E8	U-12MF3E8	U-12MF3E8	U-12MF3E8	U-16MF3E8	U-16MF3E8	U-16MF3E8	U-16MF3E8
			U-10MF3E8	U-12MF3E8	U-12MF3E8	U-12MF3E8	U-16MF3E8	U-16MF3E8	U-16MF3E8	U-16MF3E8
Power supply	Voltage	V	380-400-415	380-400-415	380-400-415	380-400-415	380-400-415	380-400-415	380-400-415	380-400-415
	Phase		Three phase	Three phase	Three phase	Three phase	Three phase	Three phase	Three phase	Three phase
	Frequency	Hz	50	50	50	50	50	50	50	50
Cooling capacity	kW		50,0	56,0	61,5	68,0	73,0	78,5	85,0	90,0
EER ¹⁾	W/W		4,90	4,31	4,24	3,89	3,88	3,65	3,59	3,49
Current	A		16,80-16,00-15,40	21,00-20,00-19,20	23,70-22,50-21,70	28,30-26,90-25,90	31,00-29,50-28,40	35,10-33,40-32,20	39,60-37,60-36,20	42,60-40,50-39,00
Input power	kW		10,20	13,00	14,50	17,50	18,80	21,50	23,70	25,8
Heating capacity	kW		56,0	63,0	69,0	76,5	81,5	87,5	95,0	100,0
COP ¹⁾	W/W		5,23	4,77	4,79	4,47	4,50	4,31	4,19	4,17
Current	A		17,70-16,80-16,20	21,30-20,30-19,50	23,50-22,30-21,50	27,60-26,30-25,30	30,20-28,70-27,70	33,50-31,80-30,70	37,90-36,00-34,70	40,10-38,10-36,70
Input power	kW		10,70	13,20	14,40	17,10	18,10	20,30	22,70	24,00
Starting current	A		2,00	2,00	2,00	2,00	3,00	3,00	4,00	4,00
External static pressure (Max)	Pa		80	80	80	80	80	80	80	80
Air flow	m ³ /min		430	442	452	464	452	464	464	464
Sound pressure	Normal mode	dB(A)	59,0	61,0	62,0	63,0	63,5	64,5	64,5	65,0
	Silent mode 1 / 2	dB(A)	56,0/54,0	58,0/56,0	59,0/57,0	60,0/58,0	60,5/58,5	61,5/59,5	61,5/59,5	62,0/60,0
Sound power	Normal mode	dB(A)	81,5	84,0	84,5	86,0	84,5	86,0	86,0	86,0
Dimension	HxWxD	mm	1842 x 2360 (+60) x 1000	1842 x 2360 (+60) x 1000	1842 x 2360 (+60) x 1000	1842 x 2360 (+60) x 1000	1842 x 2360 (+60) x 1000	1842 x 2360 (+60) x 1000	1842 x 2360 (+60) x 1000	1842 x 2360 (+60) x 1000
Net weight	kg		523	547	548	574	596	620	668	668
Piping diameter ²⁾	Liquid	Inch (mm)	5/8(15,88)/3/4(19,05)	5/8(15,88)/3/4(19,05)	5/8(15,88)/3/4(19,05)	5/8(15,88)/3/4(19,05)	3/4(19,05)/7/8(22,22)	3/4(19,05)/7/8(22,22)	3/4(19,05)/7/8(22,22)	3/4(19,05)/7/8(22,22)
	Discharge	Inch (mm)	7/8(22,22)/1(25,40)	7/8(22,22)/1(25,40)	1(25,40)/1-1/8(28,58)	1(25,40)/1-1/8(28,58)	1(25,40)/1-1/8(28,58)	1-1/8(28,58)/1-1/4(31,75)	1-1/8(28,58)/1-1/4(31,75)	1-1/8(28,58)/1-1/2(38,10)
	Suction	Inch (mm)	1-1/8(28,58)/1-1/4(31,75)	1-1/8(28,58)/1-1/4(31,75)	1-1/8(28,58)/1-1/4(31,75)	1-1/8(28,58)/1-1/4(31,75)	1-1/4(31,75)/1-1/2(38,10)	1-1/4(31,75)/1-1/2(38,10)	1-1/4(31,75)/1-1/2(38,10)	1-1/4(31,75)/1-1/2(38,10)
	Balance	Inch (mm)	1/4(6,35)	1/4(6,35)	1/4(6,35)	1/4(6,35)	1/4(6,35)	1/4(6,35)	1/4(6,35)	1/4(6,35)
Refrigerant (R410A) / CO ₂ Eq.	kg / T		13,60/28,3968	15,10/31,5288	15,10/31,5288	16,60/34,6608	15,10/31,5288	16,60/34,6608	16,60/34,6608	16,60/34,6608
Maximum allowable indoor / outdoor capacity ratio %			50 ~ 150	50 ~ 150	50 ~ 150	50 ~ 150	50 ~ 150	50 ~ 150	50 ~ 150	50 ~ 150
Operating range	Cool Min ~ Max	°C	-10 ~ +52	-10 ~ +52	-10 ~ +52	-10 ~ +52	-10 ~ +52	-10 ~ +52	-10 ~ +52	-10 ~ +52
	Heat Min ~ Max	°C	-20 ~ +18	-20 ~ +18	-20 ~ +18	-20 ~ +18	-20 ~ +18	-20 ~ +18	-20 ~ +18	-20 ~ +18
	Simultaneous op.	°C	-10 ~ +24	-10 ~ +24	-10 ~ +24	-10 ~ +24	-10 ~ +24	-10 ~ +24	-10 ~ +24	-10 ~ +24

HP			34 HP	36 HP	38 HP	40 HP	42 HP	44 HP	46 HP	48 HP
Outdoor unit			U-8MF3E8	U-8MF3E8	U-10MF3E8	U-8MF3E8	U-10MF3E8	U-12MF3E8	U-14MF3E8	U-16MF3E8
			U-10MF3E8	U-12MF3E8	U-12MF3E8	U-16MF3E8	U-16MF3E8	U-16MF3E8	U-16MF3E8	U-16MF3E8
			U-16MF3E8	U-16MF3E8	U-16MF3E8	U-16MF3E8	U-16MF3E8	U-16MF3E8	U-16MF3E8	U-16MF3E8
Power supply	Voltage	V	380-400-415	380-400-415	380-400-415	380-400-415	380-400-415	380-400-415	380-400-415	380-400-415
	Phase		Three phase	Three phase	Three phase	Three phase	Three phase	Three phase	Three phase	Three phase
	Frequency	Hz	50	50	50	50	50	50	50	50
Cooling capacity	kW		96,0	101,0	107,0	113,0	118,0	124,0	130,0	135,0
EER ¹⁾	W/W		4,10	3,90	3,88	3,72	3,72	3,58	3,55	3,49
Current	A		38,60-36,70-35,40	42,30-40,20-38,70	45,60-43,30-41,70	50,20-47,70-46,00	52,40-49,70-47,90	56,50-53,70-51,80	61,10-58,10-56,00	63,90-60,70-58,50
Input power	kW		23,40	25,90	27,60	30,40	31,70	34,60	36,60	38,70
Heating capacity	kW		108,0	113,0	119,0	127,0	132,0	138,0	145,0	150,0
COP ¹⁾	W/W		4,64	4,48	4,51	4,31	4,36	4,25	4,18	4,17
Current	A		38,90-37,00-35,60	41,60-39,50-38,10	43,60-41,40-39,90	49,30-46,80-45,10	50,60-48,10-46,30	53,70-51,00-49,10	57,90-55,00-53,00	60,10-57,10-55,00
Input power	kW		23,30	25,20	26,40	29,50	30,30	32,50	34,70	36,00
Starting current	A		4,00	4,00	4,00	5,00	5,00	5,00	6,00	6,00
External static pressure (Max)	Pa		80	80	80	80	80	80	80	80
Air flow	m ³ /min		662	674	684	674	684	696	696	696
Sound pressure	Normal mode	dB(A)	64,0	64,5	65,0	65,5	66,0	66,5	66,5	67,0
	Silent mode 1 / 2	dB(A)	61,0/59,0	61,5/59,5	62,0/60,0	62,5/60,5	63,0/61,0	63,5/61,5	63,5/61,5	64,0/62,0
Sound power	Normal mode	dB(A)	84,5	85,5	85,5	85,5	86,0	86,5	87,0	87,0
Dimension	HxWxD	mm	1842 x 3540 (+120) x 1000	1842 x 3540 (+120) x 1000	1842 x 3540 (+120) x 1000	1842 x 3540 (+120) x 1000	1842 x 3540 (+120) x 1000	1842 x 3540 (+120) x 1000	1842 x 3540 (+120) x 1000	1842 x 3540 (+120) x 1000
Net weight	kg		857	881	882	929	930	954	1002	1002
Piping diameter ²⁾	Liquid	Inch (mm)	3/4(19,05)/7/8(22,22)	3/4(19,05)/7/8(22,22)	3/4(19,05)/7/8(22,22)	3/4(19,05)/7/8(22,22)	3/4(19,05)/7/8(22,22)	3/4(19,05)/7/8(22,22)	3/4(19,05)/7/8(22,22)	3/4(19,05)/7/8(22,22)
	Discharge	Inch (mm)	1-1/8(28,58)/1-1/4(31,75)	1-1/8(28,58)/1-1/4(31,75)	1-1/4(31,75)/1-1/2(38,10)	1-1/4(31,75)/1-1/2(38,10)	1-1/4(31,75)/1-1/2(38,10)	1-1/4(31,75)/1-1/2(38,10)	1-1/4(31,75)/1-1/2(38,10)	1-1/4(31,75)/1-1/2(38,10)
	Suction	Inch (mm)	1-1/4(31,75)/1-1/2(38,10)	1-1/2(38,10)/1-5/8(41,28)	1-1/2(38,10)/1-5/8(41,28)	1-1/2(38,10)/1-5/8(41,28)	1-1/2(38,10)/1-5/8(41,28)	1-1/2(38,10)/1-5/8(41,28)	1-1/2(38,10)/1-5/8(41,28)	1-1/2(38,10)/1-5/8(41,28)
	Balance	Inch (mm)	1/4(6,35)	1/4(6,35)	1/4(6,35)	1/4(6,35)	1/4(6,35)	1/4(6,35)	1/4(6,35)	1/4(6,35)
Refrigerant (R410A) / CO ₂ Eq.	kg / T		21,90/45,72719	23,40/48,85919	23,40/48,85919	23,40/48,85919	23,40/48,85919	24,90/46,3536	24,90/51,9912	24,90/51,9912
Maximum allowable indoor / outdoor capacity ratio %			50 ~ 150	50 ~ 150	50 ~ 150	50 ~ 150	50 ~ 150	50 ~ 150	50 ~ 150	50 ~ 150
Operating range	Cool Min ~ Max	°C	-10 ~ +52	-10 ~ +52	-10 ~ +52	-10 ~ +52	-10 ~ +52	-10 ~ +52	-10 ~ +52	-10 ~ +52
	Heat Min ~ Max	°C	-20 ~ +18	-20 ~ +18	-20 ~ +18	-20 ~ +18	-20 ~ +18	-20 ~ +18	-20 ~ +18	-20 ~ +18
	Simultaneous op.	°C	-10 ~ +24	-10 ~ +24	-10 ~ +24	-10 ~ +24	-10 ~ +24	-10 ~ +24	-10 ~ +24	-10 ~ +24

1) EER and COP calculation is based in accordance to EN14511. 2) Piping diameter under 90 m for ultimate indoor unit / over 90 m for ultimate indoor unit (if the longest piping equivalent length exceeds 90 m, increase the sizes of the main tubes by 1 rank for gas tubes and liquid tubes).

Eurovent certified technical data

Panasonic's VRF systems - ECOi range is now certified by Eurovent*. The Eurovent certification verifies the performance ratings of heating and cooling systems following European standards. Data provides products efficiency with full transparency, for the benefit of customers and professionals.

Eurovent certified technical data: Mini ECOi LZ2 Series 4 to 10 HP - R32

HP	4 HP				5 HP				6 HP		8 HP		10 HP			
Outdoor unit	U-4LZ2E5		U-4LZ2E8		U-5LZ2E5		U-5LZ2E8		U-6LZ2E5		U-6LZ2E8		U-8LZ2E8		U-10LZ2E8	
Indoor units combination	MU2		MU2		MU2		MU2		MU2		MU2		MU2		MU2	
Cooling	Pc out ¹⁾ kW	12,1	12,1	14,0	14,0	15,5	15,5	22,4	28,0							
	Pec out ²⁾ kW	2,95	2,95	3,68	3,68	4,43	4,43	6,79	9,66							
	EERout	4,1	4,1	3,8	3,8	3,5	3,5	3,3	2,9							
Seasonal Cooling	SEER	8,5	8,5	8,1	8,1	7,7	7,7	7,6	7,1							
	η _{s,c} %	337	337	322	322	305	305	299	280							
Cooling PL Condition B	PcB kW	8,9	8,9	10,3	10,3	11,4	11,4	16,5	20,6							
Cooling PL Condition C	EERC	6,5	6,5	5,9	5,9	5,4	5,4	5,2	4,6							
	PcC kW	5,7	5,7	6,6	6,6	7,3	7,3	10,6	13,2							
Cooling PL Condition D	EERD	11,3	11,3	10,8	10,8	10,2	10,2	9,6	8,7							
	PcD kW	5,4	5,4	5,6	5,6	5,8	5,8	9,0	9,5							
Seasonal Heating	Pdesignh kW	15,6	15,6	15,2	15,2	15,0	15,0	16,6	18,0							
	SCOP	10,0	10,0	11,2	11,2	11,6	11,6	17,5	19,6							
	η _{s,h} %	5,1	5,1	4,6	4,6	4,6	4,6	4,6	4,6							
Heating PL Condition A	PhA kW	199,0	199,0	181,4	181,4	180,6	180,6	180,6	181,0							
	COPA	8,8	8,8	9,9	9,9	10,3	10,3	15,4	17,3							
Heating PL Condition B	PhB kW	3,1	3,1	2,9	2,9	2,9	2,9	2,9	2,8							
	COPB	5,4	5,4	6,0	6,0	6,2	6,2	9,4	10,5							
Heating PL Condition C	PhC kW	4,8	4,8	4,1	4,1	4,1	4,1	4,2	4,2							
	COPC	3,5	3,5	3,9	3,9	4,0	4,0	6,2	6,7							
Heating PL Condition D	PhD kW	7,2	7,2	7,2	7,2	7,1	7,1	6,9	7,1							
	COPD	4,0	4,0	4,0	4,0	4,0	4,0	6,7	6,9							
T bivalent	Tbiv °C	9,1	9,1	9,3	9,3	9,3	9,3	8,7	9,2							
	PhTbiv kW	-10	-10	-7	-7	-7	-7	-7	-7							
	COPTbiv	10	10	10	10	10	10	15	17							
Psbk	W	2,5	2,5	2,9	2,9	2,9	2,9	2,9	2,8							
Psbh	W	14	14	14	14	14	14	18	18							
Poffc	W	18	18	18	18	18	18	26	26							
Poffh	W	14	14	14	14	14	14	18	18							
Ptoch	W	18	18	18	18	18	18	26	26							
Pckc	W	14	14	14	14	14	14	18	18							
Pckh	W	18	18	18	18	18	18	26	26							
Sound power level	dB(A)	69	69	70	70	72	72	72	74							
Sound power level in heating	dB(A)	72	72	74	74	75	75	74	75							

Eurovent certified technical data: Mini ECOi LE Series 4 to 10 HP - R410A

HP	4 HP				5 HP				6 HP		8 HP		10 HP				
Outdoor unit	U-4LE2E5		U-4LE2E8		U-5LE2E5		U-5LE2E8		U-6LE2E5		U-6LE2E8		U-8LE1E8		U-10LE1E8		
Indoor units combination	MF2	MU2	MF2	MU2	MF2	MU2	MF2	MU2	MF2	MU2	MF2	MU2	MF2	MU2	MF2	MU2	
Cooling	Pc out ¹⁾ kW	12,1	12,1	12,1	12,1	14	14	14	14	15,5	15,5	15,5	15,5	22,4	22,4	28	28
	Pec out ²⁾ kW	2,88	2,88	2,88	2,88	3,68	3,68	3,68	3,68	4,56	4,56	4,56	4,56	7,23	7,23	10,77	10,77
	EERout	4,2	4,2	4,2	4,2	3,8	3,8	3,8	3,8	3,4	3,4	3,4	3,4	3,1	3,1	2,6	2,6
Seasonal Cooling	SEER	7,8	7,8	7,8	7,8	7,5	7,5	7,5	7,5	7,2	7,2	7,2	7,2	6,3	6,3	6,4	6,4
	η _{s,c} %	311	311	311	311	296,2	296,2	296,2	296,2	286,8	286,8	286,8	286,8	247,9	247,9	251,8	251,8
Cooling PL Condition B	PcB kW	8,9	8,9	8,9	8,9	10,3	10,3	10,3	10,3	11,4	11,4	11,4	11,4	16,5	16,5	20,6	20,6
Cooling PL Condition C	EERC	6,7	6,7	6,7	6,7	5,9	5,9	5,9	5,9	5,4	5,4	5,4	5,4	4,8	4,8	4,4	4,4
	PcC kW	5,7	5,7	5,7	5,7	6,6	6,6	6,6	6,6	7,3	7,3	7,3	7,3	10,6	10,6	13,2	13,2
Cooling PL Condition D	EERD	12,1	12,1	12,1	12,1	11	11	11	11	10,2	10,2	10,2	10,2	7,8	7,8	8,2	8,2
	PcD kW	2,7	2,7	2,7	2,7	2,9	2,9	2,9	2,9	3,4	3,4	3,4	3,4	8	8	9	9
Seasonal Heating	Pdesignh kW	9,6	9,6	9,6	9,6	10,3	10,3	10,3	10,3	11,7	11,7	11,7	11,7	12,8	12,8	15,4	15,4
	SCOP	10	10	10	10	12,5	12,5	12,5	12,5	13	13	13	13	17,5	17,5	19,6	19,6
	η _{s,h} %	4,9	4,9	4,9	4,9	4,4	4,4	4,4	4,4	4,2	4,2	4,2	4,2	4,2	4,2	4,3	4,3
Heating PL Condition A	PhA kW	191,8	191,8	191,8	191,8	172,9	172,9	172,9	172,9	166,7	166,7	166,7	166,7	166,4	166,4	169,5	169,5
	COPA	8,8	8,8	8,8	8,8	11	11	11	11	11,5	11,5	11,5	11,5	15,4	15,4	17,3	17,3
Heating PL Condition B	PhB kW	3,5	3,5	3,5	3,5	2,8	2,8	2,8	2,8	2,6	2,6	2,6	2,6	2,7	2,7	2,6	2,6
	COPB	5,3	5,3	5,3	5,3	6,7	6,7	6,7	6,7	7	7	7	7	9,4	9,4	10,5	10,5
Heating PL Condition C	PhC kW	4,1	4,1	4,1	4,1	3,7	3,7	3,7	3,7	3,6	3,6	3,6	3,6	3,8	3,8	3,9	3,9
	COPC	3,4	3,4	3,4	3,4	4,3	4,3	4,3	4,3	4,5	4,5	4,5	4,5	6	6	6,7	6,7
Heating PL Condition D	PhD kW	7,7	7,7	7,7	7,7	7,5	7,5	7,5	7,5	7,4	7,4	7,4	7,4	6,6	6,6	6,8	6,8
	COPD	4,4	4,4	4,4	4,4	4,4	4,4	4,4	4,4	4,4	4,4	4,4	4,4	6,4	6,4	6,6	6,6
T bivalent	Tbiv °C	9,8	9,8	9,8	9,8	9,8	9,8	9,8	9,8	9,8	9,8	9,8	9,8	8,1	8,1	8,9	8,9
	PhTbiv kW	-10	-10	-10	-10	-9	-9	-9	-9	-7	-7	-7	-7	-7	-7	-7	-7
	COPTbiv	10	10	10	10	12	12	12	12	11,5	11,5	11,5	11,5	15,4	15,4	17,3	17,3
Psbk	W	2,9	2,9	2,9	2,9	2,6	2,6	2,6	2,6	2,6	2,6	2,6	2,6	2,7	2,7	2,6	2,6
Psbh	W	9	9	9	9	9	9	9	9	9	9	9	9	18	18	18	18
Poffc	W	33	33	33	33	33	33	33	33	33	33	33	33	48	48	48	48
Poffh	W	9	9	9	9	9	9	9	9	9	9	9	9	18	18	18	18
Ptoch	W	33	33	33	33	33	33	33	33	33	33	33	33	48	48	48	48
Pckc	W	33	33	33	33	33	33	33	33	33	33	33	33	48	48	48	48
Pckh	W	33	33	33	33	33	33	33	33	33	33	33	33	48	48	48	48
PSB	W	33	33	33	33	33	33	33	33	33	33	33	33	48	48	48	48
Sound power level	dB(A)	69	69	69	69	71	71	71	71	73	73	73	73	79	79	83	83
Sound power level in heating	dB(A)	72	72	72	72	75	75	75	75	75	75	75	75	83	83	84	84



Eurovent certified technical data: 2-Pipe ECOi EX ME2 Series 8 to 20 HP · R410A

HP	8 HP		10 HP		12 HP		14 HP		16 HP		18 HP		20 HP			
Outdoor unit	U-8ME2E8		U-10ME2E8		U-12ME2E8		U-14ME2E8		U-16ME2E8		U-18ME2E8		U-20ME2E8			
Indoor units combination	MF2	MU2	MF2	MU2	MF2	MU2	MF2	MU2	MF2	MU2	MF2	MU2	MF2	MU2		
Cooling	Pc out ¹⁾	kW	19,7	19,7	24,6	24,6	33,5	33,5	40	40	45	45	50	50	56	56
	Pec out ²⁾	kW	5,79	5,79	8,79	8,79	11,55	11,55	13,33	13,33	18,75	18,75	17,86	17,86	23,33	23,33
	EERout		3,4	3,4	2,8	2,8	2,9	2,9	3	3	2,4	2,4	2,8	2,8	2,4	2,4
Seasonal Cooling	SEER		7,4	7,4	7	7	6,7	6,7	7,2	7,2	6,4	6,4	7,6	7,6	7	7
	$\eta_{s,c}$	%	294,3	294,3	275,4	275,4	266,6	266,6	286	286	254,3	254,3	299,2	299,2	278,2	277
Cooling PL	PcB	kW	14,5	14,5	18,1	18,1	24,6	24,6	29,4	29,4	33,1	33,1	36,8	36,8	41,2	41,2
Condition B	EERB		5,7	5,7	4,8	4,8	4,6	4,6	4,9	4,9	4,2	4,2	5	5	4,6	4,6
Cooling PL	PcC	kW	9,3	9,3	11,6	11,6	15,8	15,8	18,9	18,9	21,3	21,3	23,6	23,6	26,5	26,5
Condition C	EERC		11,8	11,8	9,6	9,6	8,1	8,1	9,4	9,4	8,2	8,2	9,8	9,8	9	9
Cooling PL	PcD	kW	8,2	8,2	9,3	9,3	8,2	8,2	8,4	8,4	9,4	9,4	10,5	10,5	11,7	11,7
Condition D	EERD		13,7	13,7	18,9	18,9	18,4	18,4	22,6	22,6	22,1	22,1	25,2	25,2	24,6	24,6
Seasonal Heating	Pdesignh	kW	17,5	17,5	22	22	26,2	26,2	31,5	31,5	35	35	39,2	39,2	44,1	44,1
	SCOP		4,8	4,8	4,3	4,3	4,7	4,7	4,3	4,3	4,1	4,1	4,3	4,3	4,1	4,1
	$\eta_{s,h}$	%	188,4	188,4	167,6	167,6	185,8	185,8	168,2	168,2	159	159	168,7	168,7	160,4	161
Heating PL	PhA	kW	15,4	15,4	19,4	19,4	23,1	23,1	27,8	27,8	30,9	30,9	34,6	34,6	39	39
Condition A	COPA		2,8	2,8	2,6	2,6	2,8	2,8	2,5	2,5	2,3	2,3	2,6	2,6	2,4	2,4
Heating PL	PhB	kW	9,4	9,4	11,8	11,8	14,1	14,1	16,9	16,9	18,8	18,8	21,1	21,1	23,7	23,7
Condition B	COPB		4,5	4,5	3,6	3,6	4,2	4,2	3,7	3,7	3,6	3,6	3,7	3,7	3,5	3,5
Heating PL	PhC	kW	6	6	7,6	7,6	9	9	10,9	10,9	12,1	12,1	13,5	13,5	15,2	15,2
Condition C	COPC		7,2	7,2	7,7	7,7	7,7	7,7	7,4	7,4	6,6	6,6	7,1	7,1	6,9	6,9
Heating PL	PhD	kW	7,1	7,1	7	7	7,2	7,2	6,7	6,7	6,6	6,6	7,4	7,4	7,4	7,4
Condition D	COPD		8,9	8,9	9,6	9,6	9,3	9,3	10,2	10,2	10	10	10,3	10,3	10,3	10,3
T bivalent	Tbiv	°C	-9	-9	-7	-7	-9	-9	-7	-7	-7	-7	-7	-7	-7	-7
	PhTbiv	kW	16,8	16,8	19,4	19,4	25,1	25,1	27,8	27,8	30,9	30,9	34,6	34,6	39	39
	COPTbiv		2,6	2,6	2,6	2,6	2,6	2,6	2,5	2,5	2,3	2,3	2,6	2,6	2,4	2,4
Psbc	W	48	48	48	48	48	48	88	88	88	88	88	88	88	88	88
Psbh	W	48	48	48	48	48	48	88	88	88	88	88	88	88	88	88
Poffc	W	48	48	48	48	48	48	88	88	88	88	88	88	88	88	88
Poffh	W	48	48	48	48	48	48	88	88	88	88	88	88	88	88	88
Ptoc	W	48	48	48	48	48	48	88	88	88	88	88	88	88	88	88
Ptoh	W	48	48	48	48	48	48	88	88	88	88	88	88	88	88	88
Pckc	W	48	48	48	48	48	48	88	88	88	88	88	88	88	88	88
Pckh	W	48	48	48	48	48	48	88	88	88	88	88	88	88	88	88
PSB	W	48	48	48	48	48	48	88	88	88	88	88	88	88	88	88
Sound power level		dB(A)	80	80	81	81	85	85	86	86	87	87	86	86	86	86
Sound power level in heating		dB(A)	81	81	84	84	85	85	85	85	89	89	89	89	89	89

Eurovent certified technical data: 3-Pipe ECOi EX MF3 Series 8 to 16 HP · R410A

HP	8 HP		10 HP		12 HP		14 HP		16 HP			
Outdoor unit	U-8MF3E8		U-10MF3E8		U-12MF3E8		U-14MF3E8		U-16MF3E8			
Indoor units combination	MF2	MU2	MF2	MU2	MF2	MU2	MF2	MU2	MF2	MU2		
Cooling	Pc out ¹⁾	kW	22,4	22,4	28	28	33,5	33,5	40	40	45	45
	Pec out ²⁾	kW	7,23	7,23	10,77	10,77	12,88	12,88	15,38	15,38	19,57	19,57
	EERout		3,1	3,1	2,6	2,6	2,6	2,6	2,6	2,6	2,3	2,3
Seasonal Cooling	SEER		7	7	7	7	6,4	6,4	6,7	6,7	6	6
	$\eta_{s,c}$	%	277	277,7	278,9	278,9	252,7	252,7	264,4	264,4	237,7	237,7
Cooling PL	PcB	kW	16,5	16,5	20,6	20,6	24,6	24,6	29,4	29,4	33,1	33,1
Condition B	EERB		4,9	4,9	4,6	4,6	4,3	4,3	4,4	4,4	3,9	3,9
Cooling PL	PcC	kW	10,6	10,6	13,2	13,2	15,8	15,8	18,9	18,9	21,3	21,3
Condition C	EERC		9,1	9,1	9,3	9,3	7,7	7,7	8,3	8,3	7,4	7,4
Cooling PL	PcD	kW	7,2	7,2	8,5	8,5	7,1	7,1	8,5	8,5	9,4	9,4
Condition D	EERD		16,5	16,5	19,7	19,7	15,7	15,7	19,7	19,7	17,4	17,4
Seasonal Heating	Pdesignh	kW	17,5	17,5	22	22	26,2	26,2	31,5	31,5	35	35
	SCOP		4,8	4,8	4,2	4,2	4,3	4,3	4,1	4,1	3,8	3,8
	$\eta_{s,h}$	%	189	190,9	166,8	166,8	167,8	167,8	162,1	162,1	149,3	149,3
Heating PL	PhA	kW	15,4	15,4	19,4	19,4	23,1	23,1	27,8	27,8	30,9	30,9
Condition A	COPA		2,9	2,9	2,5	2,5	2,7	2,7	2,4	2,4	2,2	2,2
Heating PL	PhB	kW	9,4	9,4	11,8	11,8	14,1	14,1	16,9	16,9	18,8	18,8
Condition B	COPB		4,6	4,6	3,7	3,7	3,7	3,7	3,6	3,6	3,3	3,3
Heating PL	PhC	kW	6	6	7,6	7,6	9	9	10,9	10,9	12,1	12,1
Condition C	COPC		7,1	7,1	7,4	7,4	6,9	6,9	7,1	7,1	6,5	6,5
Heating PL	PhD	kW	6,7	6,7	6,9	6,9	6,5	6,5	6,6	6,6	6,6	6,6
Condition D	COPD		8,7	8,7	9,4	9,4	9	9	9,6	9,6	9,6	9,6
T bivalent	Tbiv	°C	-9	-9	-7	-7	-9	-9	-7	-7	-7	-7
	PhTbiv	kW	16,8	16,8	19,4	19,4	25,1	25,1	27,8	27,8	30,9	30,9
	COPTbiv		2,6	2,6	2,5	2,5	2,3	2,3	2,4	2,4	2,2	2,2
Psbc	W	17	17	17	17	17	17	25	25	25	25	
Psbh	W	50	50	50	50	50	50	91	91	91	91	
Poffc	W	17	17	17	17	17	17	25	25	25	25	
Poffh	W	50	50	50	50	50	50	91	91	91	91	
Ptoc	W	17	17	17	17	17	17	25	25	25	25	
Ptoh	W	50	50	50	50	50	50	91	91	91	91	
Pckc	W	50	50	50	50	50	50	91	91	91	91	
Pckh	W	50	50	50	50	50	50	91	91	91	91	
PSB	W	50	50	50	50	50	50	91	91	91	91	
Sound power level		dB(A)	79	79	80	80	84	84	86	86	86	86
Sound power level in heating		dB(A)	77	77	82	82	86	86	86	86	88	88

ECO G, the gas driven VRF

ECO G

The advanced Gas Driven VRF system offers increased efficiency and performance across the range. Improvements include increased part load performance, reduced gas consumption with a Miller-cycle engine and reduced electrical consumption by using DC-Fan motors.



2-Pipe ECO G GE3 Series.

Designed for better energy efficiency.



3-Pipe ECO G GF3 Series.

Domestic hot water can be supplied by effectively using waste heat generated during heating and cooling operation.



1 Limited electric supply

Electric consumption of ECO G is only 9% compared to ECOi because gas engine is utilized for the compressor driving force.

2 High demand of DHW with heating and cooling cogeneration

DHW is produced effectively thanks to heat from engine exhaust during heating and cooling.

3 Open and flexible design

ECO G system is designed to connect various Indoor units and controllers which are available for ECOi systems. With GE3 series, Pump Down system has been implemented to answer commercial needs.

4 Quick start up in heating at low ambient temperature

Gas heat pump systems make your building comfortably warm with a quick start by using waste heat from engine. Heating mode works from an ambient temperature of -21 °C.

Comparison of heating capacity.

Room temperature °C

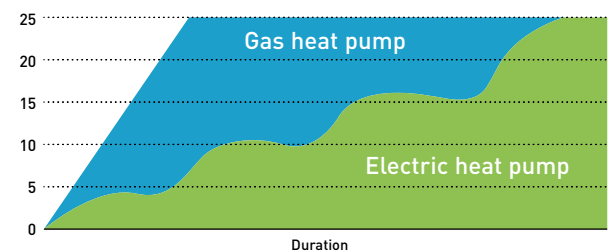

GE3/GF3 connectable indoor units

Type	Model number reference	2-Pipe ECO G GE3 Series	3-Pipe ECO G GF3 Series
Standard A2A indoor units	—	Yes ¹⁾	Yes ¹⁾
Water heat exchanger	PAW-250/500W(P)5G	Yes ²⁾	No
High static pressure hide-away	S-ME2E5	Yes	No
Heat recovery with DX coil	PAW-ZDX3N	Yes	Yes
Air curtain with DX coil	PAW-EAIRC-HS/LS	Yes	Yes ³⁾
AHU connection kit	PAW-MAH3M	Yes	Yes ³⁾

1) Except for 1,5 kW capacity. 2) Allowed 1:1 and also mixed. If mixed, not operate at the same time WHE + DX only operate separately. 3) Smaller capacity than 16 kW only.

ECO G, the gas driven VRF

ECO G satisfies special requirements for your application and offers an environmentally friendly solution with Panasonic professional technology, providing reliable quality given its long development history, since 1985.

Our ECO G VRF range of commercial systems is leading the industry in the development of efficient and flexible systems.

200.000

GHP outdoor units sold all over the world



1985

Introduces first GHP (Gas Heat Pump) VRF air conditioner.

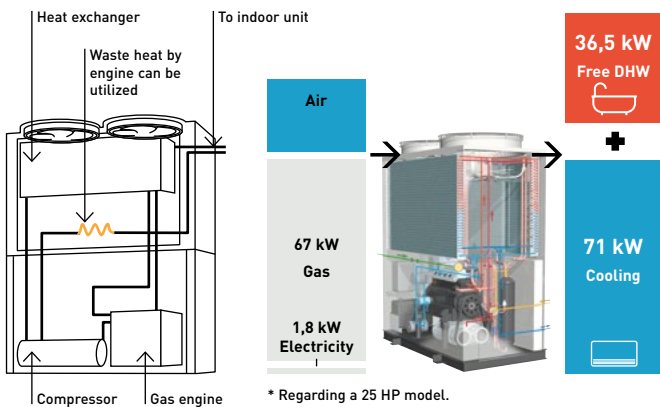

What is GHP? The Gas Heat Pump (GHP)

Panasonic Gas Heat Pump is a direct expansion system, with a compressor the same as the VRF system. A Gas engine is used as the driving force of the compressor instead of an electric motor. This gas engine compressor drive has 2 advantages:

- 1 | Waste heat available from the gas engine.
- 2 | No need for motor power consumption thanks to gas engine.

GHP is the natural choice for commercial projects, especially for those projects where electrical power restrictions apply.

Power supply problems?

If you are short of electric power, our ECO G is a perfect solution.

- Runs on natural gas or LPG and just needs single phase supply
- Enables the building's electrical power supply to be used for other critical electrical demands
- Reduces capital cost to upgrade power substations to run heating and cooling systems
- Reduces power loadings within a building especially during peak periods
- Electricity supply freed up for other uses such as IT servers, commercial refrigeration, manufacturing, lighting, etc...

Limited electricity area.

Comparison of electrical consumption on a 71 kW outdoor unit.

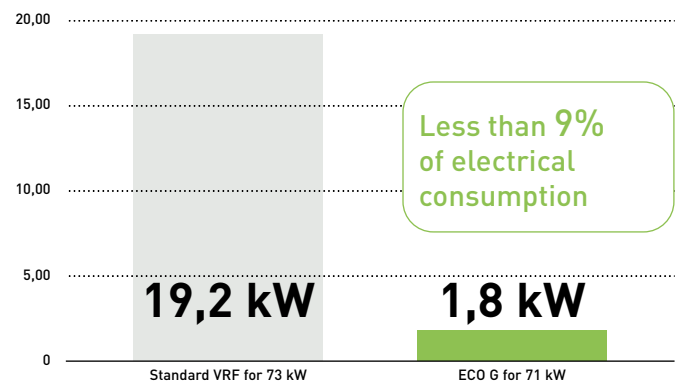

Application example: Hotel.

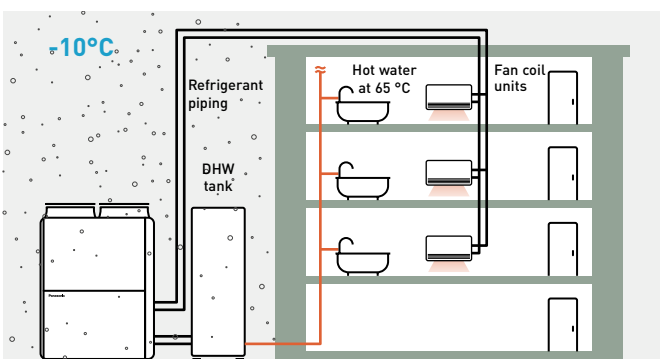

No need additional electric heaters. * This scheme is also valid with WHE.

High demand of domestic hot water in heating and cooling

The rejected heat from the engine is available for DHW production and can supply up to 46 kW of hot water at 65 °C. DHW at 65 °C is also ready to use in heating without additional electric heaters.

Quick start up and great heating capacity at low ambient temperature.

Waste heat from gas engine is utilized to raise temperature faster than electric VRF systems. This contributes great heating capacity at extremely low ambient temperature.

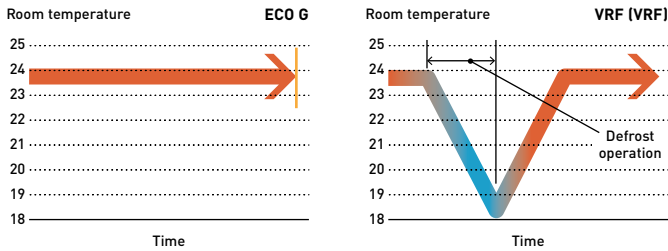

Lowest nitrogen oxide emissions.

The ECO G VRF systems have low nitrogen oxide emissions. In a pioneering development, the Panasonic ECO G features a brand lean-burn combustion system that utilizes air fuel ratio feedback control to reduce NOx emissions to an all time low.

Water chiller option.

Our ECO G system is also available with a water heat exchanger option, which can be combined with individual outdoor units or as part of a DX chilled water mix of indoor units. The system can be operated via a BMS system or a Panasonic supplied control panel, with chilled water set points from -15 °C ~ +15 °C and heating set points 35 °C ~ +55 °C.

Application

Application	Condition	ECO G
Hotel	High DHW demand	✓ Energy recovery of ECO G system can fulfill different requirement
Hotel	Needs to warm up swimming pool	✓
Office	Quick start up is necessary	✓ Speed of start up is quicker than VRF system
Winery	1) Outlet water demand at specific temperature 2) Needs high amount of power temporary (not every month)	✓ 1) Chiller application with hydro module (ECO G + WHE) can make this special process 2) Running cost can be saved since fixed Gas tariff per month is cheaper than fixed electric tariff.
Any building	In a city with power restriction	✓ - No need an additional power transformer - Space and cost can be saved
	At extremely low ambient condition	✓ Heating capacity is kept up to -20 °C without defrost process

Project case studies



Savills HQ Dublin and Google Block R. Ireland.
ECO G 3-Pipe units with a 243 kW load.
The project has been such a success that it has recently been awarded a Panasonic PRO Award for Best Contribution of efficient projects within Europe.



Thomas Cook's Sunprime Atlantic View resort.
A holiday resort in the Canaries. Spain.
229 rooms plus full spa and swimming pool facility.



CAPITA call centre. UK.
11 ECO G 3-Pipe units.
Over 150 indoor units in meeting rooms and open-plan areas.
Intelligent touch screen controller, the CZ-256ESMC2.



French winery Gennevilliers, France.
ECO G 3-Pipe units. One of the best solution utilized our ECO G solution for wine production process.

ECO G 3 Series

Introducing ECO G 3 Series. Optimised energy saving with reliable Panasonic technologies.

Improvement in blast efficiency

3-blades fan.

Propeller shape with 3 blades is more efficient
Max. 30% of fan electrical consumption is saved compared to conventional fan.

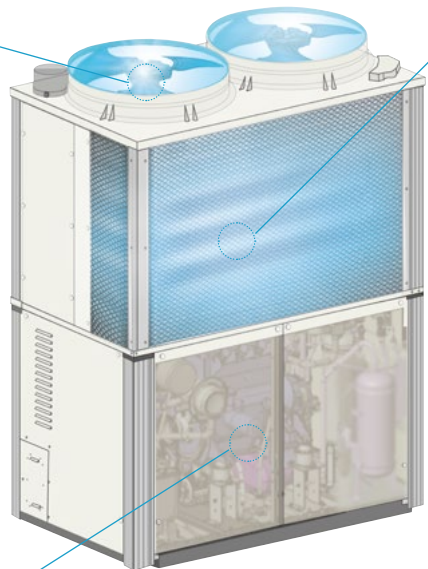
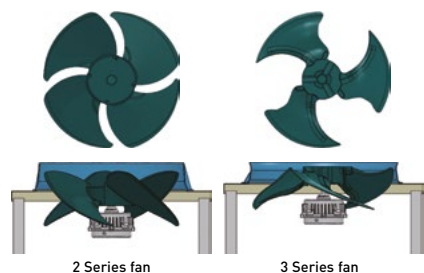

"L" type heat exchanger

Heat exchanger surface area is increased by 25% compared to previous model to optimise efficiency.

Heat exchanger surface area 25% up

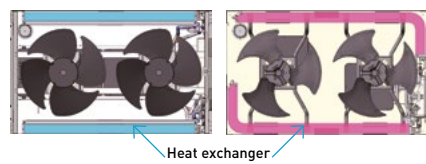

Better partial load control

Start / stop loss reduced by expanding the area where continuous operation is possible. Annual operation efficiency has further improved due to better efficiency at lower partial load.

Compressor.

- Amount of internal leakage is reduced due to reduction of clearances, the compressor efficiency in low load and low rotation region has been greatly improved. Moreover, efficiency of high speed and high load is also improved due to expansion of suction path resulting in reduction of suction pressure
- Optimise compressor capacity

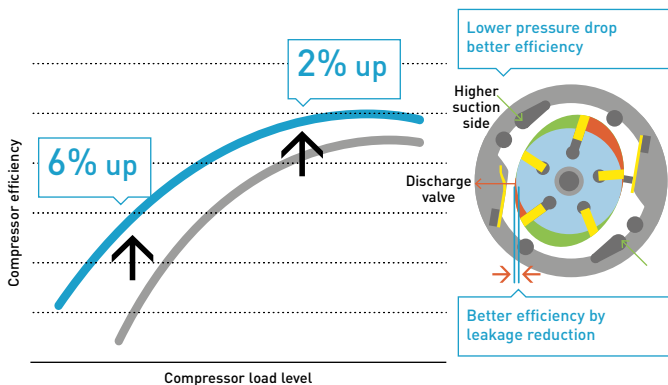

Engine.

- Continuous operation area widened at lower partial load by expanding operation area of lower speed
- Engine efficiency has improved by shifting output points to higher torque side

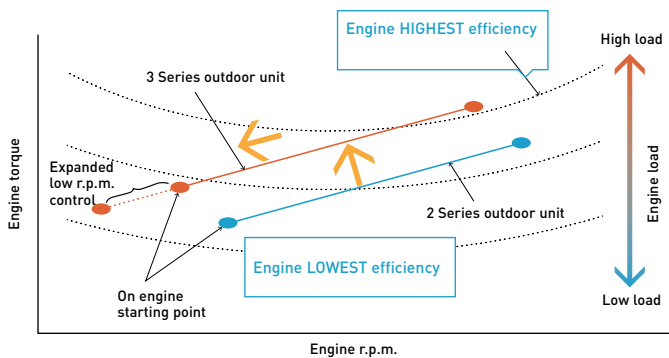

Engine pulley.

- Larger diameter engine pulley contributes to optimisation of compressor rotation speed ratio. Increased engine pulley diameter provides better performance at partial load, reducing ON / OFF operation.

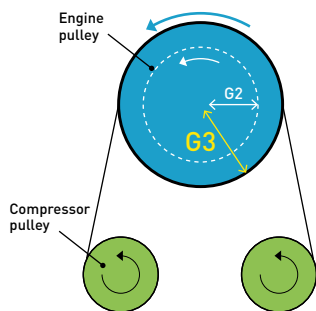

Line up of GE3 2-Pipe W-Multi.

- For new or renewal
- Available for water heat exchanger
- Maximum 60 HP combination



The highest seasonal performance in all capacity ranges.

High power efficiency of W-Multi system.

ECO G 3 Series system offers seasonal efficiency which has been drastically improved with the heat exchanger design, blast efficiency, partial load control.

Compared to previous model ECO G 2 Series.

All models have maximum 25% of SEER, 15% of SCOP improvement compared to previous model.

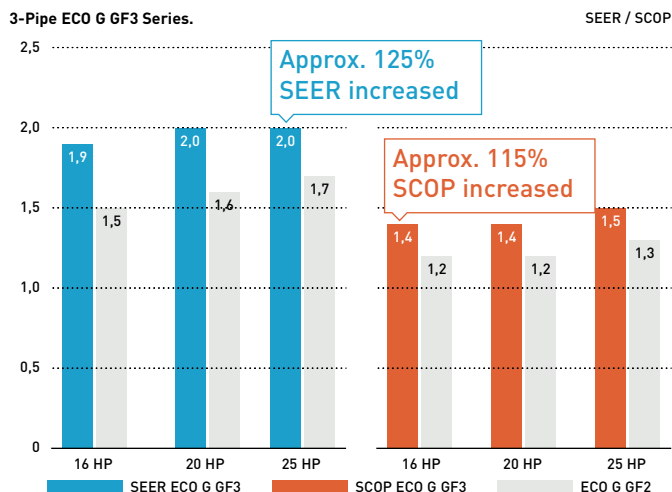
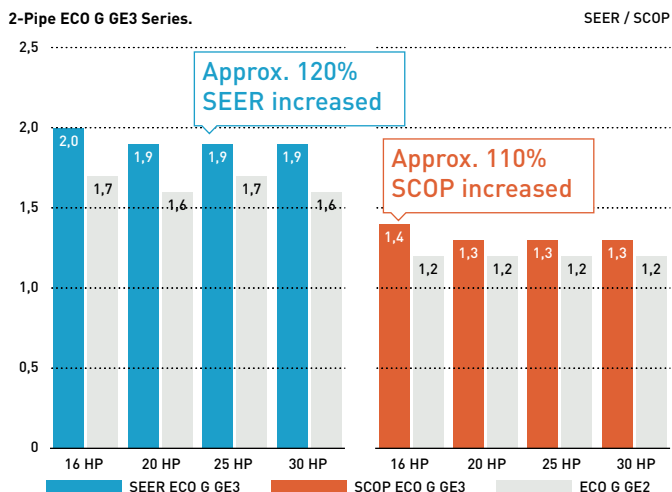

* Comparison under Panasonic condition follows EN14825.

Heating design operation conditions (GE3)

Operating range in heating has been expanded up to 24 °C (WB) for air to water use, to meet the demand of swimming pool applications.

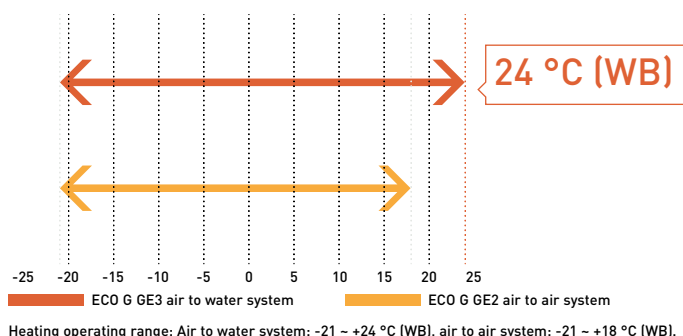

DHW priority mode setting in heating (GE3)

Ambient temperature range for DHW production is expandable by setting depending on DHW needs. Hot water at 65 °C is available in heating without additional electric heaters.

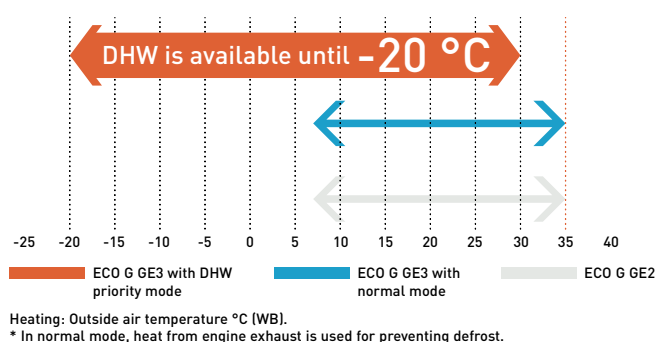

No defrost requirement (GE3 / GF3)

No defrost mode is selectable to get higher capacity at low ambient temperature.

Flexible design with wide line up of indoor units

The advanced GE3 Series can connect up to 64 indoor units.

Series	16 HP	20 HP	25 HP	30 HP	32 HP	36 HP	40 HP	45 HP	50 HP	55 HP	60 HP
2-Pipe ECO G GE3 Series	26	33	41	50	52	59	64	64	64	64	64
3-Pipe ECO G GF3 Series	24	24	24	—	—	—	—	—	—	—	—

2-Pipe ECO G GE3 Series

The GE3 Series has top level seasonal efficiency in this category. In addition, this product fits with special needs for commercial application thanks to DHW priority setting and auto Pump Down functions.



HP			16 HP	20 HP	25 HP	30 HP
Outdoor unit			U-16GE3E5	U-20GE3E5	U-25GE3E5	U-30GE3E5
Power supply	Voltage	V	220 - 230 - 240	220 - 230 - 240	220 - 230 - 240	220 - 230 - 240
	Phase		Single phase	Single phase	Single phase	Single phase
	Frequency	Hz	50	50	50	50
Cooling capacity		kW	45,0	56,0	71,0	85,0
Refrigeration load Pdesign ¹⁾		kW	45,0	56,0	71,0	85,0
$\eta_{s,c}$ (LOT21) ¹⁾			220,6%	219,3%	240,1%	229,3%
Input power		kW	1,17	1,12	1,80	1,80
Hot water in cooling mode (at 65 °C outlet)		kW	23,60	29,10	36,40	46,00
Max COP in hot water		W/W	1,55	1,55	1,49	1,47
Gas consumption cooling		kW	41,10	52,10	67,20	84,10
Heating capacity	Standard	kW	50,0	63,0	80,0	95,0
	Low temperature	kW	53,0	67,0	78,0	90,0
Refrigeration load Pdesign ¹⁾		kW	37,0	53,0	60,0	65,0
$\eta_{s,h}$ (LOT21) ¹⁾			150,6%	143,7%	146,9%	151,3%
Input power		kW	0,56	1,05	0,91	1,75
Gas consumption heating	Standard	kW	38,00	51,10	68,60	75,30
	Low temperature	kW	45,40	62,70	60,70	73,90
Starter amperes		A	30	30	30	30
External static pressure		Pa	10	10	10	10
Air flow		m ³ /min	370	420	460	460
Sound power	Normal	dB(A)	80	80	84	84
	Silent mode	dB(A)	77	77	81	81
Dimension	H x W x D	mm	2255 x 1650 x 1000	2255 x 1650 x 1000	2255 x 2026 x 1000	2255 x 2026 x 1000
Net weight		kg	765	765	870	880
Piping diameter	Liquid	Inch (mm)	1/2(12,70)	5/8(15,88)	5/8(15,88)	3/4(19,05)
	Gas	Inch (mm)	1-1/8(28,58)	1-1/8(28,58)	1-1/8(28,58)	1-1/4(31,75)
	Fuel gas	Inch (mm)	3/4(19,05)	3/4(19,05)	3/4(19,05)	3/4(19,05)
	Exhaust drain port	mm	25	25	25	25
Hot water supply in/out		Rp3/4 (Nut, thread)	Rp3/4 (Nut, thread)	Rp3/4 (Nut, thread)	Rp3/4 (Nut, thread)	
Elevation difference (in / out)			50	50	50	50
Refrigerant (R410A) / CO ₂ Eq.		kg / T	11,50/24,00	11,50/24,00	11,50/24,00	11,50/24,00
Maximum number of connectable indoor units			26	33	41	50
Operating range	Cool Min ~ Max	°C (DB)	-10 ~ +43	-10 ~ +43	-10 ~ +43	-10 ~ +43
	Heat Min ~ Max	°C (WB)	-21 ~ +18	-21 ~ +18	-21 ~ +18	-21 ~ +18

¹⁾ ErP test data.

Hot water take out function added, EU safety regulation standard cleared. 25 HP chassis enlarged due to specification improvement. Pre-coat corrosion fin. Auto Pump Down function.

Technical focus

- Superior seasonal energy efficiency, maximum 240,1%
- DHW priority setting
- Operating range in heating down to -21 °C and up to +24 °C for air to water system
- No defrost cycle

- Capacity ratio 50 ~ 200% ¹⁾
- Option of DX or chilled water for indoor heat exchange
- Maximum total piping length: 780 m

¹⁾ 50 ~ 200% only when one outdoor unit is installed. In other cases 50 ~ 130%.

2-Pipe ECO G GE3 Series combination from 32 to 60 HP

The GE3 Series has top level seasonal efficiency in this category. In addition, this product fits with special needs for commercial application thanks to DHW priority setting and Auto Pump Down functions.



HP			32 HP	36 HP	40 HP	45 HP	50 HP	55 HP	60 HP
Outdoor unit			U-16GE3E5	U-16GE3E5	U-20GE3E5	U-20GE3E5	U-25GE3E5	U-25GE3E5	U-30GE3E5
			U-16GE3E5	U-20GE3E5	U-20GE3E5	U-25GE3E5	U-25GE3E5	U-30GE3E5	U-30GE3E5
Power supply	Voltage	V	220-230-240	220-230-240	220-230-240	220-230-240	220-230-240	220-230-240	220-230-240
	Phase		Single phase	Single phase	Single phase	Single phase	Single phase	Single phase	Single phase
	Frequency	Hz	50	50	50	50	50	50	50
Cooling capacity		kW	90,0	101,0	112,0	127,0	142,0	156,0	170,0
Input power		kW	2,34	2,29	2,24	2,92	3,60	3,60	3,60
Hot water in cooling mode (at 65 °C outlet)		kW	47,20	52,70	58,20	65,50	72,80	82,40	92,00
Max COP in hot water		W/W	1,55	1,55	1,55	1,52	1,49	1,48	1,47
Gas consumption cooling		kW	82,20	93,20	104,20	119,30	134,40	151,30	168,20
Heating capacity	Standard	kW	100,0	113,0	126,0	143,0	160,0	175,0	190,0
	Low temperature	kW	106,0	120,0	134,0	145,0	156,0	168,0	180,0
Input power		kW	1,12	1,61	2,10	1,96	1,82	2,66	3,50
Gas consumption heating	Standard	kW	76,00	89,10	102,20	119,70	137,20	143,90	150,60
	Low temperature	kW	90,80	108,10	125,40	123,40	121,40	134,60	147,80
Starter amperes		A	30	30	30	30	30	30	30
External static pressure		Pa	10	10	10	10	10	10	10
Air flow		m ³ /min	370/370	370/420	420/420	420/460	460/460	460/460	460/460
Sound power	Normal	dB(A)	83	83	83	86	87	87	87
	Silent mode	dB(A)	80	80	80	83	84	84	84
Dimension	Height	mm	2255	2255	2255	2255	2255	2255	2255
	Width	mm	1650+100 +1650	1650+100 +1650	1650+100 +1650	1650+100 +2026	2026+100 +2026	2026+100 +2026	2026+100 +2026
	Depth	mm	1000	1000	1000	1000	1000	1000	1000
Net weight		kg	1530(765+765)	1530(765+765)	1530(765+765)	1635(765+870)	1740(870+870)	1750(870+880)	1760(880+880)
	Liquid	Inch (mm)	3/4(19,05)	3/4(19,05)	3/4(19,05)	3/4(19,05)	3/4(19,05)	7/8(22,22)	7/8(22,22)
Piping diameter	Gas	Inch (mm)	1-1/4(31,75)	1-1/4(31,75)	1-1/2(38,10)	1-1/2(38,10)	1-1/2(38,10)	1-1/2(38,10)	1-1/2(38,10)
	Fuel gas	Inch (mm)	3/4(19,05)	3/4(19,05)	3/4(19,05)	3/4(19,05)	3/4(19,05)	3/4(19,05)	3/4(19,05)
	Exhaust drain port	mm	25	25	25	25	25	25	25
	Hot water supply in/out		Rp3/4 (Nut, thread)	Rp3/4 (Nut, thread)	Rp3/4 (Nut, thread)	Rp3/4 (Nut, thread)	Rp3/4 (Nut, thread)	Rp3/4 (Nut, thread)	Rp3/4 (Nut, thread)
Elevation difference (in / out)		50	50	50	50	50	50	50	
Refrigerant (R410A) / CO ₂ Eq.		kg / T	2x11,50/24,00	2x11,50/24,00	2x11,50/24,00	2x11,50/24,00	2x11,50/24,00	2x11,50/24,00	2x11,50/24,00
Maximum number of connectable indoor units			52	59	64	64	64	64	64
Operating range	Cool Min ~ Max	°C	-10 ~ +43	-10 ~ +43	-10 ~ +43	-10 ~ +43	-10 ~ +43	-10 ~ +43	-10 ~ +43
	Heat Min ~ Max	°C	-21 ~ +18	-21 ~ +18	-21 ~ +18	-21 ~ +18	-21 ~ +18	-21 ~ +18	-21 ~ +18

Data is for reference. Hot water take out function added, EU safety regulation standard cleared. 25 HP chassis enlarged due to specification improvement. Pre-coat corrosion fin. Auto Pump Down function.

Technical focus

- Maximum 60 HP combination
- Superior seasonal energy efficiency, maximum 240,1%
- DHW priority setting
- Operating range in heating down to -21 °C and up to +24 °C for air to water system
- No defrost cycle
- Option of DX or chilled water for indoor heat exchange
- Maximum total piping length: 780 m



3-Pipe ECO G GF3 Series

Excellent performance and free domestic hot water

Panasonic 3-Pipe Multi system is capable of simultaneous heating / cooling and individual operation of each indoor unit by only one outdoor unit. As a result, efficient individual air conditioning is possible in buildings having diverse room temperatures. In addition, domestic hot water is created for free in cooling mode, without additional boilers or electric heaters.

System example.

Improved maintenance intervals. The unit only needs to be serviced every 10000 hours.

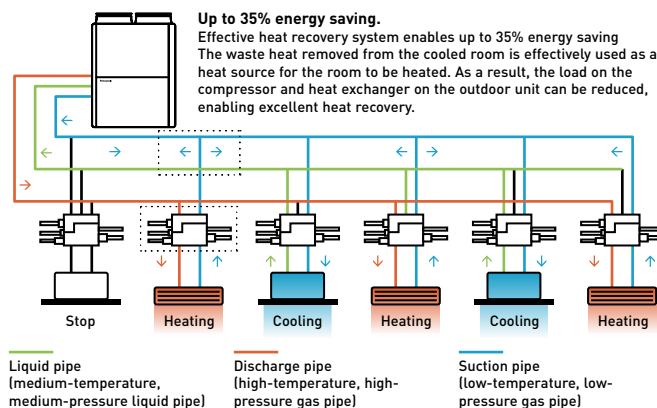

3-Pipe control solenoid valve kit.

KIT-P56HR3
(CZ-P56HR3 + CZ-CAPE2).
CZ-P56HR3
Up to 5,6 kW.

KIT-P160HR3
(CZ-P160HR3 + CZ-CAPE2).
CZ-P160HR3
Up to 16,0 kW.

3-Pipe control PCB.
CZ-CAPE2*

* For Wall-mounted. Must be added to the CZ-P56HR3 or CZ-P160HR3.

Solenoid valve kit

To be installed on all 'zones', allowing simultaneous heating and cooling. Up to 24 indoor units are capable of simultaneous heating / cooling operation. Oil-recovery operation gives more stable comfort air-conditioning control.

Power supply problems?

If you are short of electrical power, our gas heat pump could be the perfect solution:

- Runs on natural gas or LPG and needs just a single phase supply
- Enables the building's electrical power supply to be used for other critical electrical demands
- Reduces capital cost to upgrade power substations to run heating and cooling systems

- Reduces power loadings within a building especially during peak periods
- Electricity supply freed up for other uses such as IT servers, commercial refrigeration, manufacturing, lighting etc.

ECO G outdoor heat exchanger.

- Integrated DX and hot water coil
- No defrost required
- Faster reaction to demand for heating

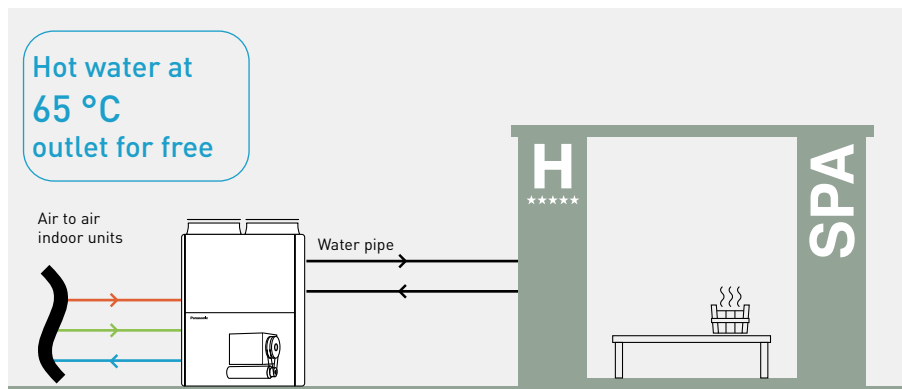
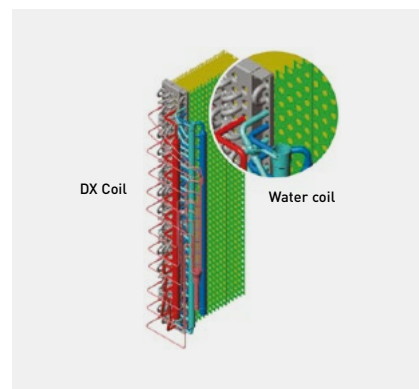

DHW production in heating and cooling

Free DHW is available 365 days a year. Hot water is produced effectively from waste heat from the engine. Perfect solution for hotel projects requiring high demand for hot water.

HP	Free DHW (in cooling mode)
16 HP	23,6 kW
20 HP	27,1 kW
25 HP	40,5 kW

3-Pipe ECO G GF3 Series

DHW available in all seasons.

Effective production of domestic hot water from engine waste heat in both heating and cooling, all year round.



HP			16 HP	20 HP	25 HP
Outdoor unit			U-16GF3E5	U-20GF3E5	U-25GF3E5
Power supply	Voltage	V	220 - 230 - 240	220 - 230 - 240	220 - 230 - 240
	Phase		Single phase	Single phase	Single phase
	Frequency	Hz	50	50	50
Cooling capacity		kW	45,0	56,0	71,0
Refrigeration load Pdesign ¹⁾		kW	45,0	56,0	71,0
$\eta_{s,c}$ (LOT21) ¹⁾			185,2%	198,8%	204,9%
Input power		kW	1,17	1,40	1,80
Hot water in cooling mode (at 65 °C outlet)		kW	23,60	27,10	40,50
Gas consumption cooling		kW	45,80	54,80	73,70
Heating capacity	Standard	kW	50,0	63,0	80,0
	Low temperature	kW	53,0	67,0	78,0
Refrigeration load Pdesign ¹⁾		kW	38,0	52,0	60,0
$\eta_{s,h}$ (LOT21) ¹⁾			139,2%	140,2%	150,9%
Input power		kW	0,56	1,05	0,91
Gas consumption heating	Standard	kW	42,20	51,10	68,60
Starter amperes		A	30	30	30
Air flow		m ³ /min	370	400	460
Sound power	Normal	dB(A)	80	81	84
	Silent mode	dB(A)	77	78	81
Dimension	H x W x D	mm	2255 x 1650 x 1000	2255 x 1650 x 1000	2255 x 2026 x 1000
Net weight		kg	775	775	880
Piping diameter	Liquid	Inch (mm)	3/4 (19,05)	3/4 (19,05)	3/4 (19,05)
	Gas	Inch (mm)	1 1/8 (28,58)	1 1/8 (28,58)	1 1/8 (28,58)
	Discharge	Inch (mm)	7/8 (22,22)	1 (25,40)	1 (25,40)
	Fuel gas	Inch (mm)	3/4 (19,05)	3/4 (19,05)	3/4 (19,05)
	Exhaust drain port	mm	25	25	25
Hot water supply in/out		Rp ³ / ₄ (Nut, thread)	Rp ³ / ₄ (Nut, thread)	Rp ³ / ₄ (Nut, thread)	
Elevation difference (in / out)		m	50	50	50
Refrigerant (R410A) / CO ₂ Eq.		kg / T	11,50 / 24,00	11,50 / 24,00	11,50 / 24,00
Maximum number of connectable indoor units			24	24	24
Operating range	Cool Min ~ Max	°C	-10 ~ +43	-10 ~ +43	-10 ~ +43
	Heat Min ~ Max	°C	-21 ~ +18	-21 ~ +18	-21 ~ +18

1) ErP test data.

Hot water take out function added, EU safety regulation standard cleared. 25 HP chassis enlarged due to specification improvement. Pre-coat corrosion fin. Auto Pump Down function.

Solenoid valve kit

KIT-P56HR3	3-Pipe control solenoid valve kit (up to 5,6 kW)
CZ-P56HR3	Solenoid valve kit (up to 5,6 kW)
CZ-CAPE2	3-Pipe control PCB
KIT-P160HR3	3-Pipe control solenoid valve kit (from 5,6 to 16,0 kW)
CZ-P160HR3	Solenoid valve kit (from 5,6 kW to 16,0 kW)
CZ-CAPE2	3-Pipe control PCB
CZ-CAPEK2 ⁴⁾	3-Pipe control PCB for wall-mounted

3-Pipe control box kit

CZ-P456HR3	4 ports 3 pipe box (up to 5,6 kW per port)
CZ-P656HR3	6 ports 3 pipe box (up to 5,6 kW per port)
CZ-P856HR3	8 ports 3 pipe box (up to 5,6 kW per port)
CZ-P4160HR3	4 ports 3 pipe box (up to 16,0 kW per port)

4) Available for S-45/56/73/106MK2E5B.

Outstanding seasonal energy efficiency, maximum 204,9%

- Capacity ratio 50 ~ 200%
- No defrost cycle
- Maximum total piping length: 780 m

Flexible installation

- Full heating capacity down to -21 °C (WB)
- DHW production for all the year
- Connection of up to 24 indoor units



Panasonic GHP/EHP Hybrid System. First intelligent technology

Taking advantage of Gas and Electricity to achieve better energy savings.

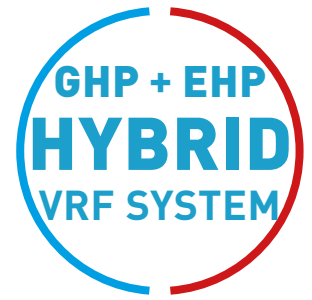

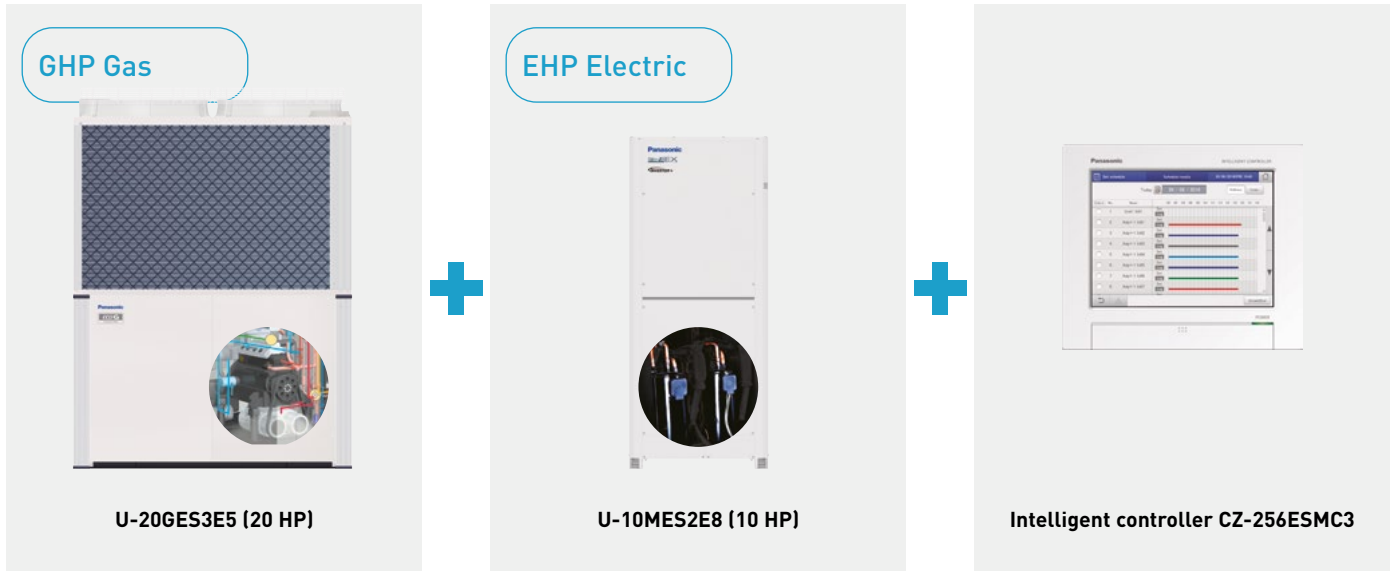

- Master unit GHP**
- Load calculation of GHP and EHP
 - Operation in accordance with the upper limit setting
 - Individual capacity control
 - Device control
 - Special control (Defrost, Oil recovery, 4 Way-valve matching / Abnormality processing)
- Slave Unit EHP**
- Intelligent controller**
- Demand monitoring
 - Indoor / total load calculation
 - Operation Ratio Indication
 - upper limit setting of MAP according to:
 - Energy unit RRP
 - Electric power demand
 - Air conditioning load

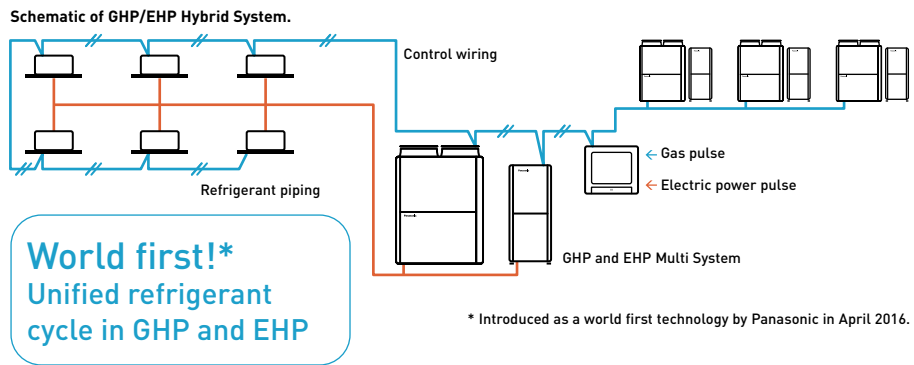

1 Peak cut of electricity consumption

Electrical peak demand is significantly reduced thanks to GHP system consuming less than 10% of electricity of EHP system.

* Image of Hotel project.

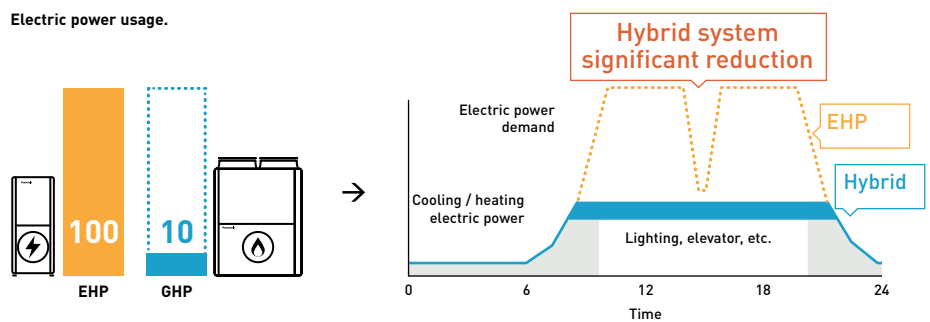

2 Optimal control to maximize energy saving

Switching the operation between GHP and EHP system on the basis of usage, energy demand, part load.

* Specification is tentative.

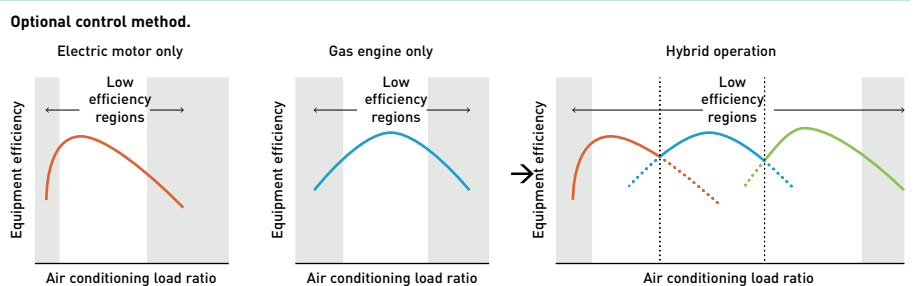

3 Free hot water production by GHP system

Hot water is effectively produced from waste heat of engine.

* Specification is tentative.

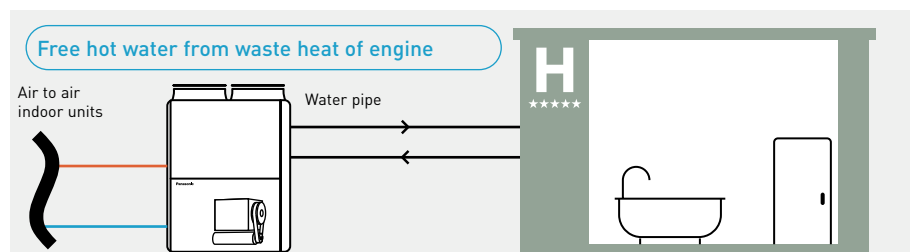

GHP/EHP Hybrid System

Panasonic's reliable ECO G / ECOi technology provides energy savings, utilising the advantages of both gas and electricity

The hybrid system can offer intelligent operation logic for better economy and efficiency by taking the best of ECO G. A heating and cooling system operating in a similar way to a hybrid car.

How to smartly operate a GHP and EHP system depending on your needs

4 different mode settings are available with the intelligent controller. Switch the operation between GHP and EHP or operating both units together to maximize the effect for different requirements such as economy and efficiency.

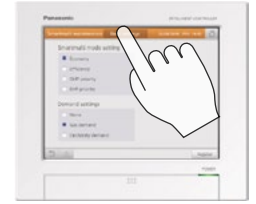

Economy mode

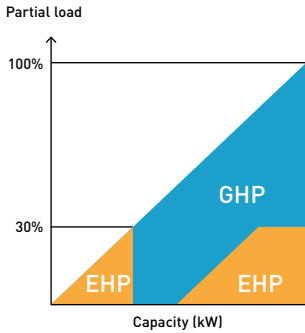

Efficiency mode

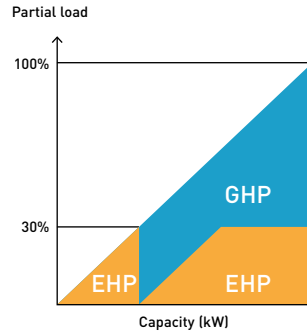

GHP priority mode

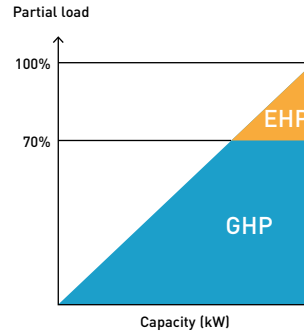

EHP priority mode

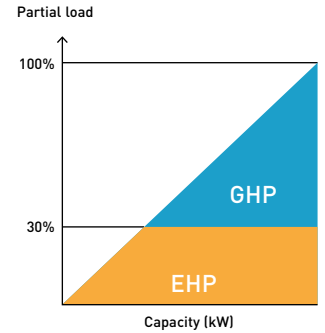

Optimal control example: Economy mode

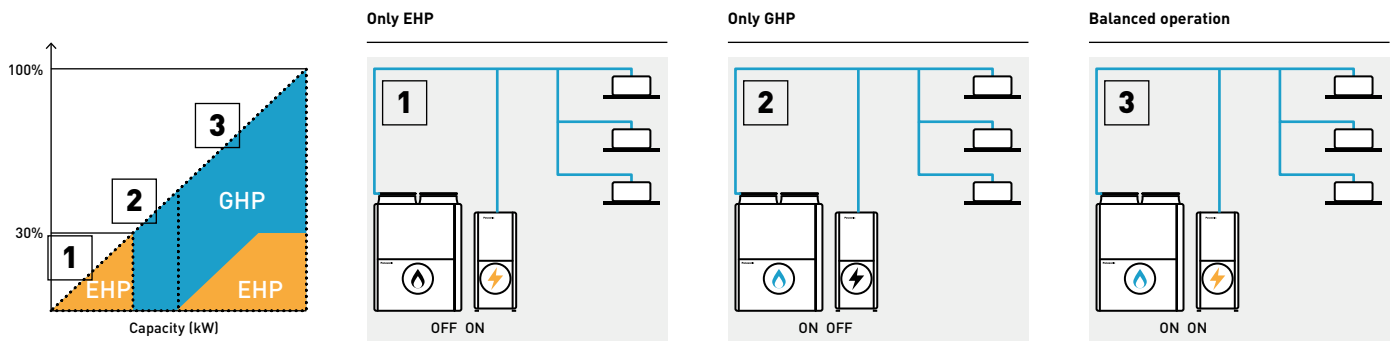

DHW priority mode in Hybrid + WHE System

When DHW is required during cooling operation by EHP, EHP is automatically turned "OFF" and GHP is turned "ON" to produce DHW for free.

High efficiency mode.

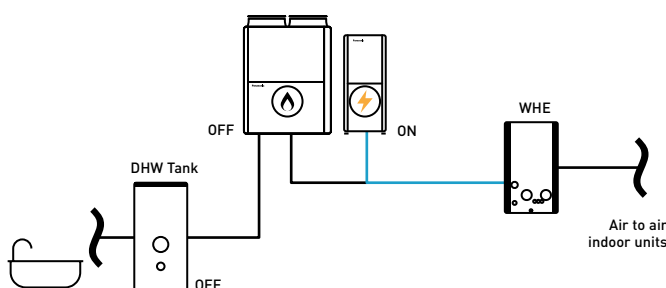

DHW priority mode.

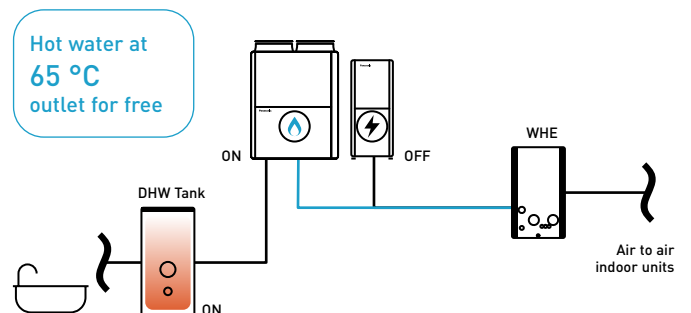

2-Pipe Hybrid GHP/EHP

- Extended lifespan with intelligent energy management.
The goal is for the EHP and GHP to work at optimal speeds
- Low energy cost
- Low emissions



			Hybrid GHP	Hybrid EHP
			20 HP	10 HP
			U-20GES3E5	U-10MES2E8
Outdoor unit				
Power supply	Voltage	V	220 - 230 - 240	380 - 400 - 415
	Phase		Single phase	Three phase
	Frequency	Hz	50	50
Cooling capacity		kW	56,0	28,0
$\eta_{s,c}$ (LOT21)			211,8%	275,4%
Current		A	5,18	10,70/10,20/9,80
Input power		kW	1,12	6,41
Hot water in cooling mode (at 65 °C outlet)		kW	26,20	—
Gas consumption cooling		kW	52,10	—
Heating capacity		kW	63,0	31,5
$\eta_{s,h}$ (LOT21)			143,2%	167,6%
Current		A	4,79	11,10/10,50/10,10
Input power		kW	1,05	6,62
Gas consumption heating	Standard	kW	51,10	—
Starting current		A	30	1
Air flow		m ³ /min	420	224
Sound pressure	Normal mode	dB(A)	58	56
Sound power	Normal mode	dB(A)	80	77
Dimension	HxWxD	mm	2255x1650x1000	1842x770x1000
Net weight		kg	765	210
Piping diameter ¹⁾	Liquid	Inch (mm)	5/8 (15,88)	3/8 (9,52)
	Gas	Inch (mm)	1 1/8 (28,58)	7/8 (22,22)
	Balance	Inch (mm)	1/4 (6,35)	1/4 (6,35)
Drain heater		W	40	—
Refrigerant (R410A) / CO ₂ Eq.		kg / T	11,05/23,0724	5,60/11,6928
Maximum allowable indoor / outdoor capacity ratio %			50 - 130	50 - 130
Operating range	Cool Min ~ Max	°C	-10 ~ +43	-10 ~ +43
	Heat Min ~ Max	°C	-21 ~ +18	-21 ~ +18

1) Please refer service manual when the maximum piping length exceeds 90 meters (equivalent length).

Technical focus

- 4 settings (economy, efficiency, GHP priority mode, EHP priority mode)
- DHW energy recovery 26,2 kW (at 65 °C) by engine waste heat
- Unified refrigerant cycle in GHP and EHP for easy installation
- DHW priority mode with WHE system
- Connection of up to 48 indoor units



Water heat exchanger for hydronic applications

Panasonic water heat exchanger available with ECOi (VRF) and ECO G (gas driven VRF) systems. Those are suitable not only for new projects but also for the old chiller systems to be replaced.



Chiller replacement. Chilled water supply to fan coils

Chiller replacement.

When some old chillers needed replacing at the end of their operational lifetime, ECO Gs with water heat exchangers enabled the project to be carried out in stages whilst still utilising the existing water pipe work and fan coils. This enabled the project to be delivered on time, to a restricted budget and avoided all issues regarding refrigerant in confined spaces.



Connection to 'close control' computer equipment.

Computer room applications.

When all available electrical power needed to be utilised for the IT equipment for a leading international bank, the cooling load of over 450 kW had to be powered by gas. The outdoor units were connected via water heat exchangers to cooling coils inside the 'close control' units thereby maintaining a conditioned environment for temperature and humidity. By utilising the hot water function over 100 kW of hot water are supplied to the building and therefore the additional benefit of considerable CO₂ savings is ensured.

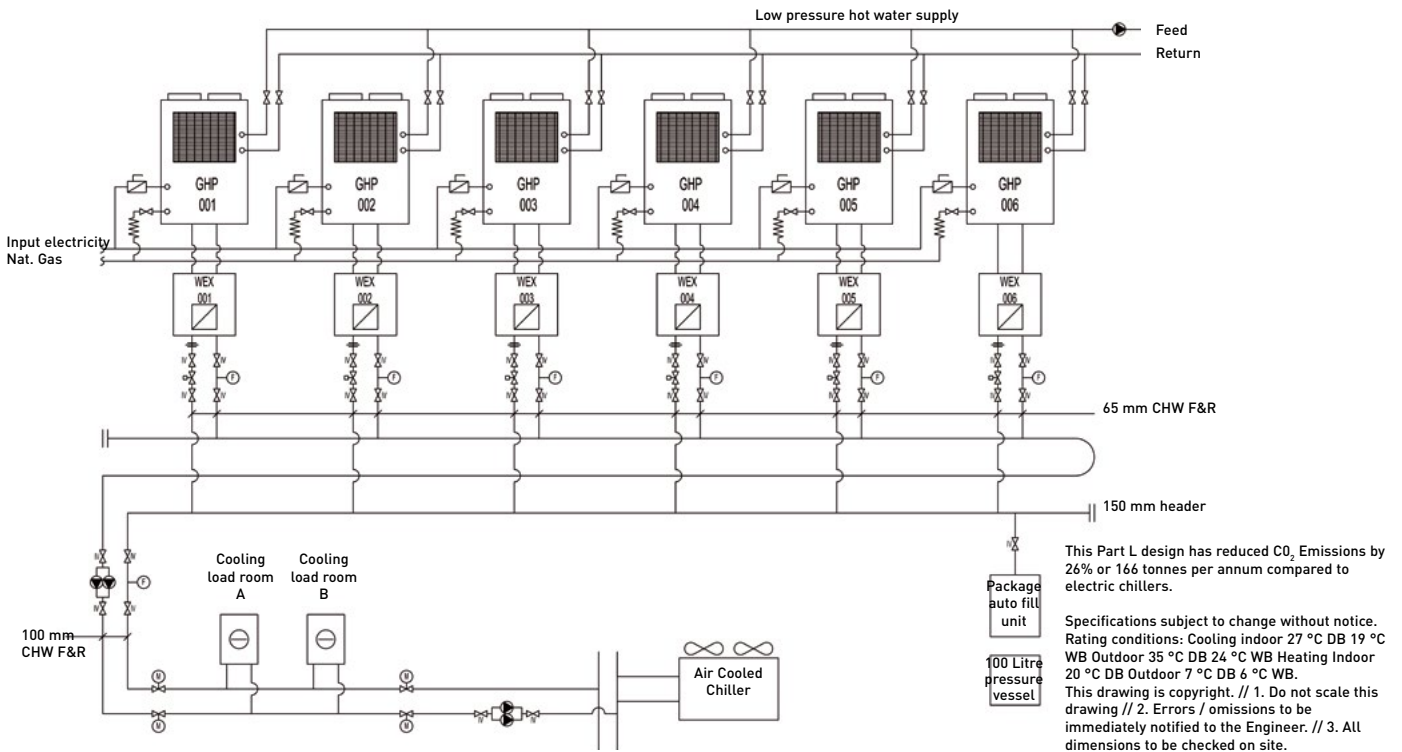

ECOi water heat exchanger

Electrical VRF with water heat exchanger
 · With this easy to install water heat exchanger unit, you can now cover projects up to 51 kW hot water demand or 44 kW on chilled application in an efficient and cost effective way

System example.

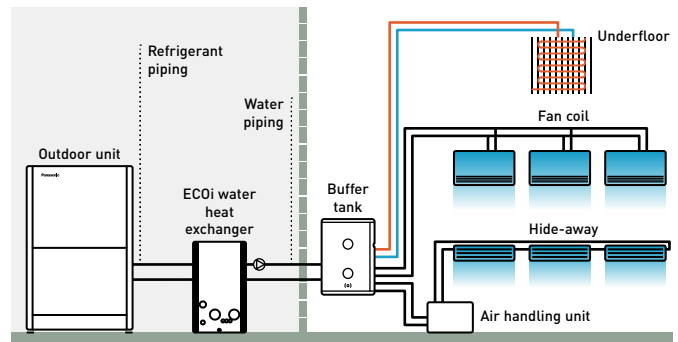

A buffer tank of minimum 280 l for 28 kW and 500 l for 50 kW is always needed.

Example of Hotel renewal of existing chiller and boiler system with Panasonic ECO G and Aquarea mixed solution

ECO G and Aquarea are the smart solution for renewal Chiller / Boiler applications with annual running cost savings around 13600€.

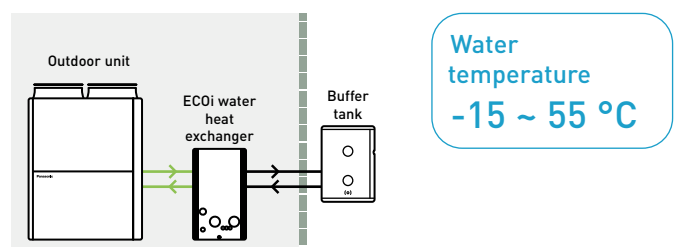

ECOi 2-Pipe with water heat exchanger for chilled and hot water production

Water heat exchanger (WHE) for hydronic applications.

WHE for ECOi systems controlled by a CZ-RTC5B timer remote control.

Energy-efficient capacity control with superior external static pressure is now ready.

Availability of easy vertical stacking allows installations in a limited space (up to 3 units)*.

Stainless steel plate heat exchanger with anti-freeze protection control.

Change over between heating and cooling operation.

* Stacking kit (PAW-3WSK) is necessary.



Hydrokit with A class water pump		PAW-250WP5G1	PAW-500WP5G1
Hydrokit without pump		PAW-250W5G1	PAW-500W5G1
Cooling capacity (A 35 °C, W 7 °C)	kW	25,0	50,0
Heating capacity	kW	28,0	56,0
Heating capacity (A +7 °C, W 45 °C)	kW	28,0	56,0
COP (A +7 °C, W 45 °C)	W/W	2,97	3,10
Energy efficiency class at 35 °C¹⁾		A++	A++
$\eta_{s,h}$ (LOT1)²⁾		152,0%	152,0%
Dimension	HxWxD	mm	1000 x 575 x 1110
Net weight		kg	135 (140 with pump)
Water pipe connector			Rp2 Female thread (50A)
Heating water flow ($\Delta T=5$ K, 35 °C)	m ³ /h		5,16
Electric backup heater	kW		Not equipped
Flow switch			Equipped
Water filter			Equipped
Input power with A class water pump / without pump	kW		0,329 / 0,024
Maximum current with A class water pump / without pump	A		1,43 / 0,10
Outdoor unit		U-10ME2E8	U-20ME2E8
Sound pressure		dB(A)	56
Dimension	HxWxD	mm	1842 x 770 x 1000
Net weight		kg	210
Piping diameter	Liquid	Inch (mm)	3/8(9,52)
	Gas	Inch (mm)	7/8 (22,22)
Pipe length range / Pipe length for nominal capacity	m		170 / 7,5
Elevation difference (in / out)	m		50 (OU above) 35 (OU below)
Pre-charged pipe length / Additional gas amount (R410A)	m / g/m		0 < / Refer to manual
Refrigerant (R410A) / CO ₂ Eq.	kg		5,6 (need additional gas amount at site)
Operating range	Heat Min ~ Max	°C	-11 ~ +15 ³⁾
Water outlet temperature range	Cool Min ~ Max	°C	+5 ~ +15
	Heat Min ~ Max	°C	+35 ~ +45

1) Unit efficiency energy level: Scale from A+++ to D. 2) Seasonal space cooling / heating energy efficiency following COMMISSION REGULATION (EU) 813/2013. 3) With accessory low temperature kit -25 ~ +15 °C. Available only as a spare part.

Performance calculation in agreement with Eurovent. Sound pressure measured at 1 m from the outdoor unit and at 1,5 m height.

Accessories

PAW-3WSK Stacking kit for vertically stacking up to 3 WHE [4 pieces per Kit]

Stacking kit PAW-3WSK.

It is possible to stack up to 3 units. When stacking units, always anchor the bottom unit to the ground using the anchor holes.

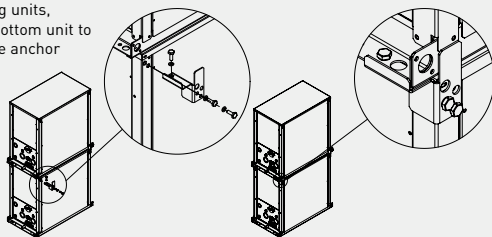

Technical focus

- Heating, cooling and DHW
- A class water pump included (only in P model)
- Flexible modularity from 25 kW
- Better partial load vs standard chiller system
- Compatible with all centralized controllers
- Maximum distance between outdoor unit and WHE: 170 m
- Maximum hot water outlet temperature: 45 °C
- Minimum chilled water outlet temperature: 5 °C
- Outdoor temperature range in heating mode: -11 °C to +15 °C (with low temperature kit -25 °C*)

* Available as a spare part.



ECO G with water heat exchanger for chilled and hot water production

Water heat exchanger (WHE) for hydronic applications.

WHE for ECO G system controlled by a timer remote control CZ-RTC5B.

Energy-efficient capacity control is now ready.

Availability of easy vertical stacking allows installations in a limited space (up to 3 units)*.

Stainless steel plate heat exchanger with anti-freeze protection control.

Change over between heating and cooling operation.

* Stacking kit (PAW-3WSK) is necessary.



Hydrokit with A class water pump			PAW-500WP5G1	PAW-710WP5G1
Hydrokit without pump			PAW-500W5G1	PAW-710W5G1
Cooling capacity	kW		—	—
Cooling capacity [A +35 °C, outlet W 7 °C, inlet W 12 °C]	kW		50,0	67,0
EER [A +35 °C, outlet W 7 °C, inlet W 12 °C]	W/W		0,78	0,89
Heating capacity	kW		60,0	80,0
Heating capacity [A +7 °C, W 35 °C]	kW		60,9	81,2
COP [A +7 °C, W 35 °C]	W/W		1,15	1,18
Heating capacity [A +7 °C, W 45 °C]	kW		60,0	80,0
COP [A +7 °C, W 45 °C]	W/W		1,02	1,04
Heating capacity [A -7 °C, W 35 °C]	kW		48,2	50,8
COP [A -7 °C, W 35 °C]	W/W		0,80	0,80
Heating capacity [A -15 °C, W 35 °C]	kW		46,3	50,0
COP [A -15 °C, W 35 °C]	W/W		0,80	0,80
Refrigeration load Pdesign	kW		48,0	—
Energy efficiency class at 35 °C¹⁾			A+	—
η_{s,h} (LOT1)²⁾			130,0%	128,0%
Dimension	HxWxD	mm	1000 x 575 x 1110	1000 x 575 x 1110
Net weight		kg	155 (165 with pump)	160 (175 with pump)
Water pipe connector			Rp2 Female thread (50A)	Rp2 Female thread (50A)
Heating water flow [ΔT=5 K, 35 °C]	m ³ /h		10,32	13,76
Electric backup heater	kW		Not equipped	Not equipped
Flow switch			Equipped	Equipped
Water filter			Equipped	Equipped
Input power with A class water pump / without pump	kW		0,574 / 0,024	0,824 / 0,024
Maximum current with A class water pump / without pump	A		2,50 / 0,10	3,60 / 0,10
Outdoor unit			U-20GE3E5	U-30GE3E5
Sound power	Normal / Silent	dB(A)	80 / 77	84 / 81
Dimension	HxWxD	mm	2255 x 1650 x 1000	2255 x 2026 x 1000
Net weight		kg	765	880
Piping diameter	Liquid	Inch (mm)	5/8 (15,88)	3/4 (19,05)
	Gas	Inch (mm)	1-1/8 (28,58)	1-1/4 (31,75)
Pipe length range / Pipe length for nominal capacity		m	170 / 7	170 / 7
Elevation difference (in / out)		m	50 [OU above] 35 [OU below]	50 [OU above] 35 [OU below]
Refrigerant (R410A) / CO ₂ Eq.		kg / T	11,50 / 24,00	11,50 / 24,00
Operating range	Heat Min ~ Max	°C	-21 ~ +24 (until outlet temperature 45)	-21 ~ +24 (until outlet temperature 45)
Water outlet temperature range	Cool Min ~ Max	°C	-15 ~ +15	-15 ~ +15
	Heat Min ~ Max	°C	+35 ~ +55	+35 ~ +55

1) Unit efficiency energy level: Scale from A+++ to D. 2) ErP test data. Seasonal space cooling / heating energy efficiency following COMMISSION REGULATION (EU) 813/2013.

Performance calculation in agreement with Eurovent. Sound pressure measured at 1 m from the outdoor unit and at 1,5 m height.

Accessories

PAW-3WSK Stacking kit for vertically stacking up to 3 WHE [4 pieces per Kit]

Technical focus

- Heating, cooling and DHW
- A class water pump included (only in P model)
- Installation up to 80 kW
- Free DHW from waste heat of engine
- Compatible with all centralized controllers
- Maximum distance between outdoor unit and WHE: 170 m
- Hot water outlet temperatures from 35 °C to 55 °C
- Chilled water outlet temperatures from -15 °C to +15 °C
- Minimum outdoor temperature in heating mode: -21 °C



Leak detection and automatic Pump Down for R410A refrigerant

Pump Down Systems to detect refrigerant leaks, that offers complete assurance and safety protection. It's an ideal solution for hotels, offices and public buildings where the strict safety of end users and workers is required.



The system monitors refrigerant leakage continually and provides a warning, preventing major refrigerant loss and potential damage to the installation's efficiency. The system can reduce potential refrigerant loss by up to 90%.

As well as ensuring safe and reliable operation, Panasonic's Pump Down system contributes towards BREEAM POL1 points and enables compliance with current EN 378 standards, covering applications where refrigeration concentration levels exceed practical safety limits of 0,44 kg/m³.

Basic Pump Down function:

- Leak detection
- Activate Pump Down process
- Collect refrigerant within receiver tank
- Close valves to isolate refrigerant

Technical focus:

- Compatible with Mini ECOi / ECOi EX / ECO G* Series with R410A refrigerant
- A receiver kit included as standard
- Includes updated controller
- Connection in two ways:
 - 1 | With local room leakage sensors
 - 2 | Using innovative algorithm
- R22 renewal possible

* For connection to GHP, additional components required dependent on configuration. Please contact your local Panasonic representative for details.



The Pump Down systems are ideal for hotels, offices and public buildings where safety of building occupants is a must.

Direct leak detection method: the safest solution for small rooms

The leak detector is connected directly to the indoor unit and the Pump Down system is directly connected to the outdoor unit PCB. The Pump Down system will activate when a leak is detected in the room and initiate a refrigerant reclaim operation immediately. This immediate reaction, and large refrigerant storage capacity, offers very high levels of safety for end users, building occupants, as well as being environmentally friendly. No additional communication panels or software is required. This option should be implemented in any area that is not compliant with BS EN 378.

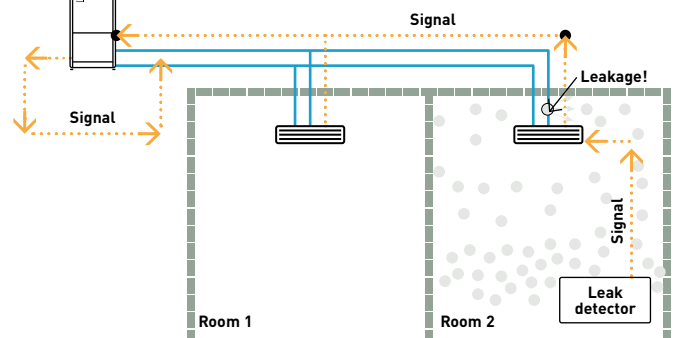

Indirect leak detection method: Unique PLC algorithm to determine refrigerant leakage

Pressure and temperature sensors constantly monitor the high / low pressure and discharge of the condensing unit to protect against potential leakage in areas not covered by leak detectors. The innovative algorithm is able to detect leakage of R410A based on abnormal changes in the following conditions, high and low pressure, and compressor discharge temperature. Once initiated via either direct or indirect detection, the unit will immediately close the liquid / discharge actuating ball valves, close the alarm terminals on the Pump Down PCB allowing an alarm to be raised at any nominated location. Reclaim of the refrigerant is via the suction line to the heat exchanger(s) of the outdoor unit(s), with any surplus refrigerant collected in the 30 l receiver tank. Once fully pumped down the suction line is closed and the unit awaits a 'Reset' and 'Recharge' command. Thanks to the simple installation and control, shown in Fig 1, Panasonic's ECOi Pump Down system can provide dramatic reduction in capital cost and installation time when compared to a standalone leak detection system, shown in Fig 2.

Fig 1: Panasonic's Pump Down system.

Fig 2: Standalone leak detection system.

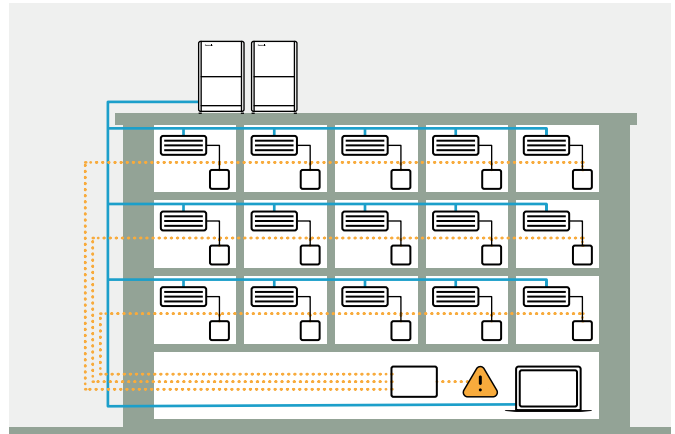
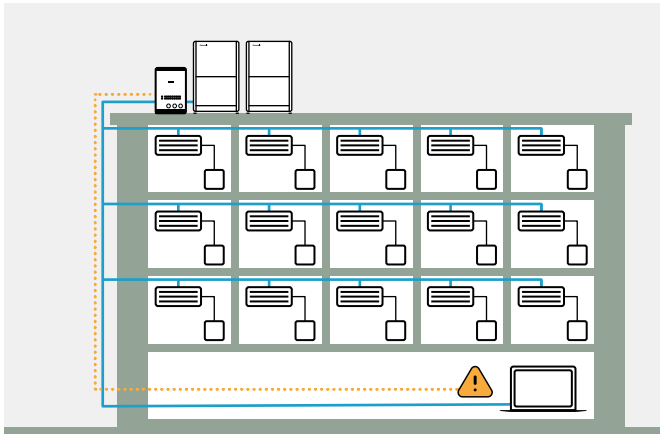

Quick and simple installation

The unit contains actuating ball valves, a 30 L storage vessel and PLC all housed in an IP54 rated encasement. Terminals in front of the unit allow easy wiring to the alarm terminal, high / low pressure transducers and discharge temperature sensor(s) of the condensing unit(s).

Reference	Description
PAW-PUD2W-1R	Pump Down system (2 way) for 1 outdoor unit
PAW-PUD2W-2R	Pump Down system (2 way) for 2 outdoor units
PAW-PUD2W-3R*	Pump Down system (2 way) for 3 outdoor units
PAW-PUD3W-1R	Pump Down system (3 way) for 1 outdoor unit
PAW-PUD3W-2R	Pump Down system (3 way) for 2 outdoor units
PAW-PUD3W-3R*	Pump Down system (3 way) for 3 outdoor units

* Special order requiring the longer lead time than usual. For the detailed information, please contact an authorized Panasonic dealer.

Design support software for VRF

Features the unique Mounting Scheme function, providing thorough spec-in and tender quotation support for easier and faster completion of work.

The Panasonic VRF Designer software for Panasonic's latest R410A and R32 VRF Systems

The VRF Designer software makes the selection and design process as quick and easy as possible. The design package utilises system wizards and import tools to enable both simple and complex systems to be created. In addition, the system will allow outdoor and indoor units to be dragged on an interactive desktop. This allows users to create everything from realistic floor plans with detailed piping and wiring schematics, through to installation guidance drawings, which can be sent with quotations.

Main features:

- Mounting scheme. Design selection from building floor drawing
- Variety of drawing formats. (dxf, jpg, png..etc.)
- Conventional principal scheme
- Easy to use system wizards
- Auto piping and wiring features
- Converted duties for conditions and pipework
- Auto(CAD) (dxf), Excel and PDF export
- Detailed wiring and pipework diagrams
- Automatic price quotation
- Automatic tender document assist
- SEER, SCOP
- ESEER



New Panasonic DX PRO Designer

The Panasonic DX PRO Designer will be rebuilt with an improved user experience. The new software runs in the cloud and is always up to date with the latest products. An intuitive interface supports the most complicated designs, allows online sharing and project collaboration with multilingual support.

Key benefits:

- Possible to access your projects from wherever you are
- Make the collaboration process easy and effective
- Automatic version updates
- Great flexibility and scalability
- Intuitive interface with consistent multiple languages
- All key features of the VRF Designer

* Available in Spring 2023.

Coming soon

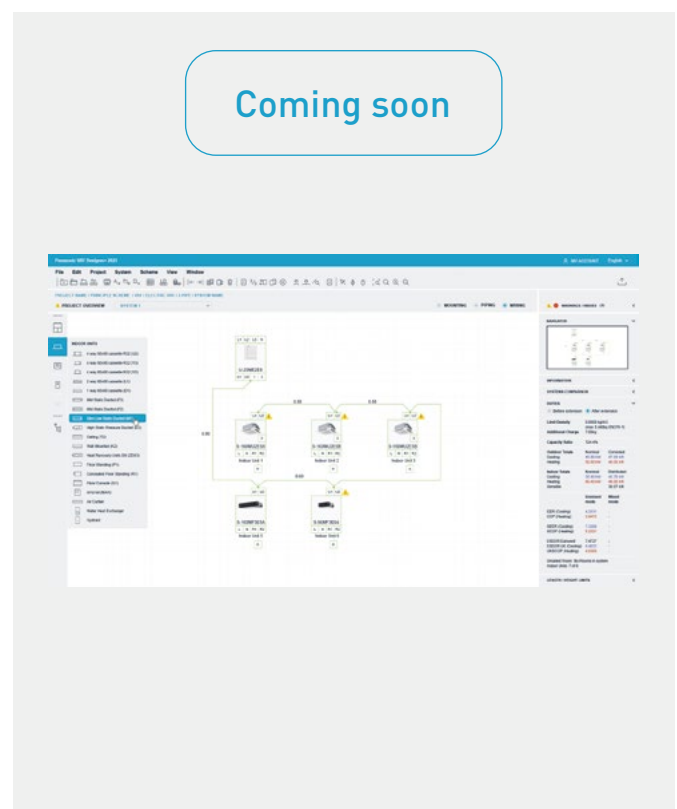

Panasonic's Advanced VRF software with AutoCAD® compatibility makes design easier than ever.

Panasonic provides bespoke software helping system designers, installers and dealers to very quickly design and size systems, create wiring diagrams and issue bill of quantities at the push of a button.



Panasonic VRF service checker

Available to installers and commissioning companies, the VRF service checker is a communication interface to Panasonic VRF systems. This easy to manage tool checks all parameters of the system.



The VRF service checker:

- Connect anywhere on the S-Link for ECOi and Mini ECOi
- Search the S-Link to validate systems that are connected
- Monitor all indoor and outdoor units simultaneously on 1 screen
- Monitor all Temperature data, Pressure data, Valve position, and alarm status
- Data can be viewed in Graph or tabular display
- Controlling the indoor unit ON / OFF, MODE, SET POINT, FAN, and TEST mode
- Switch between various systems on the same communication S-Link (ECOi only)
- Monitor and record at a set interval
- Record and review the data at a later date
- Update Panasonic system software via ROM flash writer

The Panasonic VRF service checker is available from your local service partner.



















































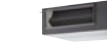

























R22 Renewal

Panasonic's advanced technology enables the system to work with previously installed pipe work by managing the working pressure within the system down to R22 (33 bar) levels, this ensures the system works safely and efficiently without loss of capacity. The new equipment can offer increased COP / EER by using state of the art Inverter compressor and heat exchanger technology.

Having contacted your Panasonic supplier regarding pipe work restrictions, and gained approval to use the Panasonic Renewal System, there are three main tests that have to be carried out to ensure that the system can be used effectively. Firstly a thorough inspection of the pipe work must be carried out and any damage must be repaired. Secondly an oil test must be performed to ensure that the system has not been subject to a compressor burnout during its lifetime. Lastly a VRF Renewal Kit (CZ-SLK2) must be installed within the pipe work to ensure that the system is cleaned and free of oil remnants.



ECOi and ECO G systems indoor units range

Page	Indoor units	1,5 kW	2,2 kW	2,8 kW	3,6 kW	4,5 kW	5,6 kW
P. 305	NEW U2 type 4 way 90x90 cassette with integrated nanoe X Generator Mark 3 · R32 / R410A		 S-22MU2E5BN	 S-28MU2E5BN	 S-36MU2E5BN	 S-45MU2E5BN	 S-56MU2E5BN
P. 305	U2 type 4 way 90x90 cassette with integrated nanoe X Generator Mark 2 · R32 / R410A		 S-22MU2E5B	 S-28MU2E5B	 S-36MU2E5B	 S-45MU2E5B	 S-56MU2E5B
P. 306	Y3 type 4 way 60x60 cassette · R32 / R410A	 S-15MY3E	 S-22MY3E	 S-28MY3E	 S-36MY3E	 S-45MY3E	 S-56MY3E
P. 307	L1 type 2 way cassette · R410A		 S-22ML1E5	 S-28ML1E5	 S-36ML1E5	 S-45ML1E5	 S-56ML1E5
P. 308	D1 type 1 way cassette · R410A			 S-28MD1E5	 S-36MD1E5	 S-45MD1E5	 S-56MD1E5
P. 309	NEW F3 type variable static pressure adaptive duct with integrated nanoe X Generator Mark 3 · R32 / R410A	 S-15MF3E5BN S-15MF3E5AN	 S-22MF3E5BN S-22MF3E5AN	 S-28MF3E5BN S-28MF3E5AN	 S-36MF3E5BN S-36MF3E5AN	 S-45MF3E5BN S-45MF3E5AN	 S-56MF3E5BN S-56MF3E5AN
P. 309	F3 type variable static pressure adaptive duct with integrated nanoe X Generator Mark 2 · R32 / R410A	 S-15MF3E5B S-15MF3E5A	 S-22MF3E5B S-22MF3E5A	 S-28MF3E5B S-28MF3E5A	 S-36MF3E5B S-36MF3E5A	 S-45MF3E5B S-45MF3E5A	 S-56MF3E5B S-56MF3E5A
P. 310	F2 type variable static pressure hide-away · R410A	 S-15MF2E5A	 S-22MF2E5A	 S-28MF2E5A	 S-36MF2E5A	 S-45MF2E5A	 S-56MF2E5A
P. 311	M1 type slim variable static pressure hide-away · R32 / R410A	 S-15MM1E5B	 S-22MM1E5B	 S-28MM1E5B	 S-36MM1E5B	 S-45MM1E5B	 S-56MM1E5B
P. 312	E2 type high static pressure hide-away · R410A						
P. 313	Heat recovery with DX coil · R410A			 PAW-500ZDX3N (3 kW)		 PAW-800ZDX3N (5,1 kW)	 PAW-01KZDX3N (5,8 kW)
P. 314	T2 type ceiling · R410A				 S-36MT2E5A	 S-45MT2E5A	 S-56MT2E5A
P. 315	K2 type wall-mounted · R32 / R410A	 S-15MK2E5B	 S-22MK2E5B	 S-28MK2E5B	 S-36MK2E5B	 S-45MK2E5B	 S-56MK2E5B
P. 316	G1 type floor console · R410A		 S-22MG1E5N	 S-28MG1E5N	 S-36MG1E5N	 S-45MG1E5N	 S-56MG1E5N
P. 317	P1 type floor-standing · R410A		 S-22MP1E5	 S-28MP1E5	 S-36MP1E5	 S-45MP1E5	 S-56MP1E5
P. 318	R1 type concealed floor-standing · R410A		 S-22MR1E5	 S-28MR1E5	 S-36MR1E5	 S-45MR1E5	 S-56MR1E5
P. 319	Hydrokit for ECOi, water at 45 °C · R410A						



+ OPTIONAL UNITS ON VENTILATION SECTION

6,0 kW

7,3 kW

9,0 kW

10,6 kW

11,2 kW

14,0 kW

16,0 kW

22,4 kW

28,0 kW



S-60MU2E5BN



S-73MU2E5BN



S-90MU2E5BN



S-112MU2E5BN



S-140MU2E5BN



S-160MU2E5BN



S-60MU2E5B



S-73MU2E5B



S-90MU2E5B



S-106MU2E5B



S-140MU2E5B



S-160MU2E5B



S-73ML1E5



S-73MD1E5



S-60MF3E5BN
S-60MF3E5AN



S-73MF3E5BN
S-73MF3E5AN



S-90MF3E5BN
S-90MF3E5AN



S-112MF3E5BN
S-112MF3E5AN



S-140MF3E5BN
S-140MF3E5AN



S-160MF3E5BN
S-160MF3E5AN



S-60MF3E5B
S-60MF3E5A



S-73MF3E5B
S-73MF3E5A



S-90MF3E5B
S-90MF3E5A



S-106MF3E5B
S-106MF3E5A



S-140MF3E5B
S-140MF3E5A



S-160MF3E5B
S-160MF3E5A



S-60MF2E5A



S-73MF2E5A



S-90MF2E5A



S-106MF2E5A



S-140MF2E5A



S-160MF2E5A



S-224ME2E5



S-280ME2E5



S-73MT2E5A



S-106MT2E5A



S-140MT2E5A



S-73MK2E5B



S-106MK2E5B



S-71MP1E5



S-71MR1E5



S-80MW1E5



S-125MW1E5

New 4 way 90x90 cassette with nanoe X Generator Mark 3



Large capacity VRF. Trusted power and high efficiency. These Cassettes offer upgraded nanoe™ X technology and Econavi as accessories for making application space more comfortable and efficient.

Thanks to advances in design and technology such as the high performance turbo fan which is more efficient and silent, nanoe™ X technology, and the floor temperature and humidity sensor (Econavi) for more control, the Panasonic U2 type 4 way 90x90 cassette offers greater comfort.

The nanoe™ X performance varies depending on the room size, environment and usage and it may take several hours to reach the full effect. nanoe™ X is not medical device, local regulations on building design and sanitary recommendations must be followed.



Always fresh and clean air with nanoe™ X

The 4 way 90x90 cassette with nanoe™ X, when tested, has shown to inhibit hazardous substances by 92%, when compared to natural reduction*.

In addition to the 7 effects of nanoe™ X, the indoor unit can also be cleaned with a short operation of nanoe™ X + dry mode.

* Controllers (CZ-RTC5B or CZ-RTC6/BL/BLW) are required.

After cooling/drying operation, the inside of the indoor unit is automatically dried and nanoe™ X is activated to suppress mould growth.

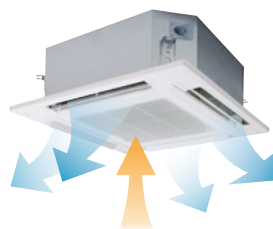

Operates the fan to discharge internal humidity.



Operate the fan to circulate nanoe™ X internally.

Optional Econavi intelligent sensor

Human activity sensor and floor temperature sensor can reduce waste energy, by optimising air conditioner operation.

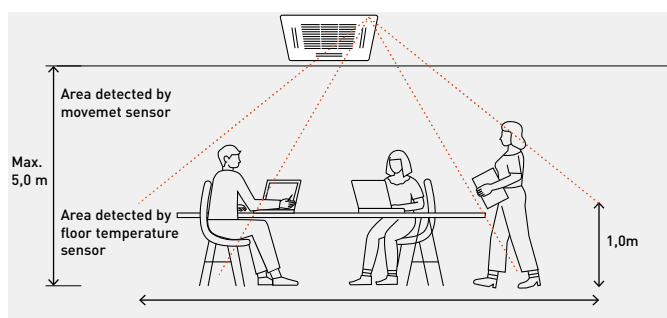

Advanced Econavi functions.

2 sensors (movement and floor temperature) can provide a reduction in wasted energy by means of effective control. The floor temperature can be detected with a ceiling height of up to 5 m.



Econavi exclusive panel. Optional (CZ-KPU3AW)



Floor temperature sensor.
This sensor detects average floor temperature and operates circulation if floor temperature is low.

Movement sensor.
This sensor detects the amount of human activity, and operates effectively.



Wired remote controller CZ-RTC5B or CZ-RTC6/BL is required.

Humidity sensor.

A humidity sensor positioned in the air inlet provides comfort and saves energy based on temperature and humidity.

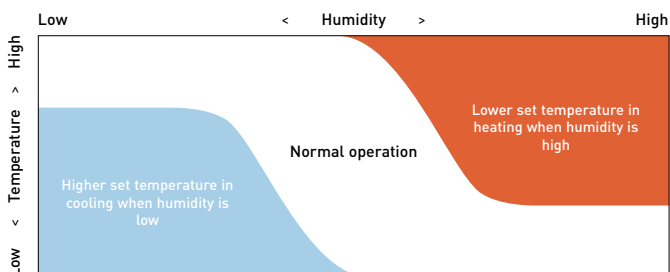

Group control, circulation function.

Circulating operation is activated when a room is unoccupied to evenly distribute air and minimize thermal stratification in both heating and cooling operation.

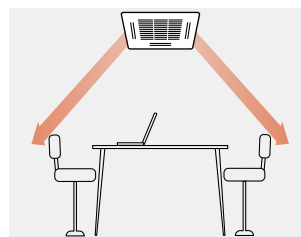

Circulation by detecting no movement (10 minutes).

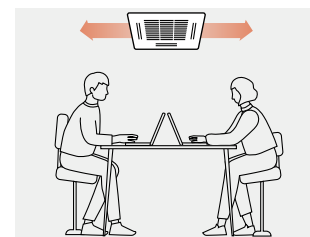

Indirect air flow by detecting movement.

NEW U2 type 4 way 90x90 cassette · R32 / R410A

The 4 way 90x90 cassettes with integrated nanoe X Generator Mark 3 and design panel.

A modern flat panel design blends into any space. These cassettes provide high energy saving, comfort and better indoor air quality that satisfy customers.



+ COMPATIBLE WITH ALL PANASONIC CONNECTIVITY SOLUTIONS. FOR DETAILED INFORMATION GO TO THE CONTROL SYSTEMS SECTION

NEW Indoor unit. S-***MU2E5BN		22	28	36	45	56	60	73	90	—	112	140	160	
nanoe X Generator		Mark 3	Mark 3	Mark 3	Mark 3	Mark 3	Mark 3	Mark 3	Mark 3	—	Mark 3	Mark 3	Mark 3	
Indoor unit. S-***MU2E5B		22	28	36	45	56	60	73	90	106	—	140	160	
nanoe X Generator		Mark 2	Mark 2	Mark 2	Mark 2	Mark 2	Mark 2	Mark 2	Mark 2	Mark 2	—	Mark 2	Mark 2	
Cooling capacity	kW	2,2	2,8	3,6	4,5	5,6	6,0	7,3	9,0	10,6	11,2	14,0	16,0	
Input power	W	20,00	20,00	20,00	20,00	25,00	35,00	40,00	40,00	90,00	95,00	95,00	105,00	
Current	A	0,21	0,21	0,21	0,21	0,23	0,33	0,36	0,38	0,71	0,74	0,74	0,82	
Heating capacity	kW	2,5	3,2	4,2	5,0	6,3	7,1	8,0	10,0	11,4	14,0	16,0	18,0	
Input power	W	20,00	20,00	20,00	20,00	25,00	35,00	40,00	40,00	85,00	90,00	90,00	100,00	
Current	A	0,20	0,20	0,20	0,20	0,22	0,32	0,35	0,37	0,69	0,72	0,72	0,80	
Fan type		Turbo fan	Turbo fan	Turbo fan	Turbo fan	Turbo fan	Turbo fan	Turbo fan	Turbo fan	Turbo fan	Turbo fan	Turbo fan	Turbo fan	
Air flow	Hi/	m ³ /min	128 ¹⁾ / 12,1 ¹⁾ /11,5 ¹⁾	128 ¹⁾ / 12,1 ¹⁾ /11,5 ¹⁾	14,5/13,0/ 11,5	15,5/13,0/ 11,5	16,5/13,5/ 11,5	21,0/16,0/ 13,0	22,5/16,0/ 13,0	23,0/18,5/ 14,0	34,0/25,0/ 19,0	36,0/26,0/ 20,0	36,0/26,0/ 20,0	37,0/28,0/ 24,0
	Med/ Lo													
Sound pressure		dB(A)	30/29/28	30/29/28	30/29/28	31/29/28	32/30/28	36/32/29	37/32/29	38/35/32	44/38/34	45/39/35	45/39/35	46/40/38
Sound power		dB(A)	45/44/43	45/44/43	45/44/43	46/44/43	47/45/43	51/47/44	52/47/44	53/50/47	59/53/49	60/54/50	60/54/50	61/55/53
Dimension (HxWxD)	Indoor	mm	256 x 840 x 840	256 x 840 x 840	256 x 840 x 840	256 x 840 x 840	256 x 840 x 840	256 x 840 x 840	256 x 840 x 840	256 x 840 x 840	319 x 840 x 840	319 x 840 x 840	319 x 840 x 840	319 x 840 x 840
	Panel	mm	33,5 x 950 x 950	33,5 x 950 x 950	33,5 x 950 x 950	33,5 x 950 x 950	33,5 x 950 x 950	33,5 x 950 x 950	33,5 x 950 x 950	33,5 x 950 x 950	33,5 x 950 x 950	33,5 x 950 x 950	33,5 x 950 x 950	33,5 x 950 x 950
Net weight (Panel)	kg		19 (5)	19 (5)	19 (5)	19 (5)	19 (5)	20 (5)	20 (5)	20 (5)	25 (5)	25 (5)	25 (5)	25 (5)
Piping diameter R32 model	Liquid	Inch (mm)	1/4 (6,35)	1/4 (6,35)	1/4 (6,35)	1/4 (6,35)	1/4 (6,35)	1/4 (6,35)	1/4 (6,35)	1/4 (6,35)	3/8 (9,52)	3/8 (9,52)	3/8 (9,52)	3/8 (9,52)
	Gas	Inch (mm)	1/2 (12,70)	1/2 (12,70)	1/2 (12,70)	1/2 (12,70)	1/2 (12,70)	1/2 (12,70)	1/2 (12,70)	1/2 (12,70)	5/8 (15,88)	5/8 (15,88)	5/8 (15,88)	5/8 (15,88)
Piping diameter R410A model	Liquid	Inch (mm)	1/4 (6,35)	1/4 (6,35)	1/4 (6,35)	1/4 (6,35)	1/4 (6,35)	3/8 (9,52) ²⁾	3/8 (9,52) ²⁾	3/8 (9,52) ²⁾	3/8 (9,52)	3/8 (9,52)	3/8 (9,52)	3/8 (9,52)
	Gas	Inch (mm)	1/2 (12,70)	1/2 (12,70)	1/2 (12,70)	1/2 (12,70)	1/2 (12,70)	5/8 (15,88) ²⁾	5/8 (15,88) ²⁾	5/8 (15,88) ²⁾	5/8 (15,88)	5/8 (15,88)	5/8 (15,88)	5/8 (15,88)

1) The data for S-***MU2E5B is different. Please refer the technical manual. 2) When the piping diameter is (liquid) Ø1/4 (6,35) - (gas) Ø1/2 (12,70), connect the liquid socket tube (Ø1/4 (6,35) - Ø3/8 (9,52)) to the liquid tubing side indoor unit and connect the gas socket tube (Ø1/2 (12,70) - Ø5/8 (15,88)) to the gas tubing side indoor unit. * Above values are in the case of nanoe™ X OFF.

Accessories	
CZ-RTC6W	CONEX wired remote controller (non-wireless), white
CZ-RTC6WBL	CONEX wired remote controller with Bluetooth®, white
CZ-RTC6	CONEX wired remote controller (non-wireless), black
CZ-RTC6BL	CONEX wired remote controller with Bluetooth®, black
CZ-RTC5B	Wired remote controller with Econavi function
CZ-RWS3 + CZ-RWRU3W	Infrared remote controller and receiver
PAW-RE2C4-MOD-WH	Room controller for hotel rooms, white
PAW-RE2C4-MOD-BK	Room controller for hotel rooms, black

Accessories	
PAW-RE2D4-WH	Display control for hotel rooms, white
PAW-RE2D4-BK	Display control for hotel rooms, black
CZ-KPU3W	Standard panel
CZ-KPU3AW	Econavi exclusive panel
CZ-CENS1	Econavi energy saving sensor
CZ-FDU3 + CZ-ATU2	Fresh air-intake kit
CZ-CGLSC1	Panasonic R32 refrigerant leak detector

Technical focus

- High performance turbo fan
- Lower noise in low fan operation
- Ceiling height up to 5,0 m
- Industry leading lightweight design
- Econavi: Temperature, humidity and activity sensor
- nanoe™ X as standard. MU2E5BN: Generator Mark 3: 48 trillion hydroxyl radicals/sec. MU2E5B: Generator Mark 2: 9,6 trillion hydroxyl radicals/sec
- Indoor unit internal cleaning with nanoe™ X plus dry operation
- Powerful drain pump gives 850 mm lift
- Fresh air knockout
- Branch duct connection
- High volume fresh air input with optional air-intake plenum and chamber (CZ-FDU3+CZ-ATU2)

Panel design

Flat design, well-matched with interior aesthetic. 4-way individual flap control.

The drain pipe can be raised to a maximum height of 850 mm from the bottom of the ceiling

Integrated drain pump allows a drain height of 850 mm making the installation much easier.

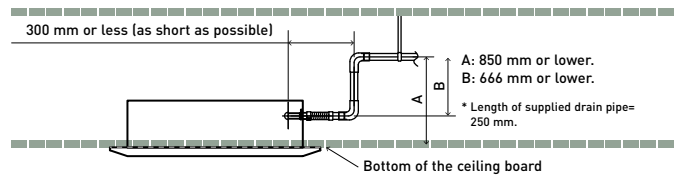

ECONAVI and INTERNET CONTROL: Optional.

Rating conditions: Cooling indoor 27 °C DB / 19 °C WB. Cooling outdoor 35 °C DB / 24 °C WB. Heating indoor 20 °C DB. Heating outdoor 7 °C DB / 6 °C WB. (DB: Dry Bulb; WB: Wet Bulb). Specifications subject to change without notice. For detailed information about ErP / Energy Labelling, please visit our websites www.aircon.panasonic.eu or www.ptc.panasonic.eu.

Y3 type 4 way 60x60 cassette · R32 / R410A

Mini cassette with a modern panel design is available in VRF range.

The Y3 type not only perfectly matches with 600 x 600 mm ceiling grids but also provides the additional benefits of nanoe™ X, for better indoor air quality.

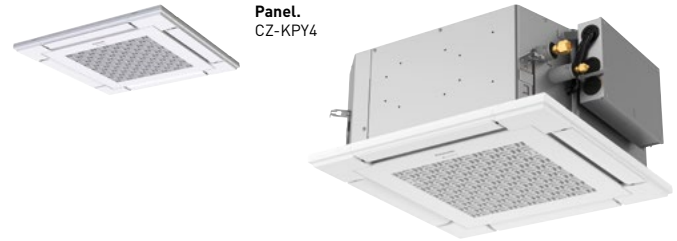

+ COMPATIBLE WITH ALL PANASONIC CONNECTIVITY SOLUTIONS. FOR DETAILED INFORMATION GO TO THE CONTROL SYSTEMS SECTION

Indoor unit			S-15MY3E	S-22MY3E	S-28MY3E	S-36MY3E	S-45MY3E	S-56MY3E
Cooling capacity	kW		1,5	2,2	2,8	3,6	4,5	5,6
Input power	W		19,00	20,00	21,00	22,00	30,00	42,00
Current	A		0,24	0,24	0,25	0,26	0,34	0,43
Heating capacity	kW		1,7	2,5	3,2	4,2	5,0	6,3
Input power	W		17,00	18,00	19,00	20,00	28,00	40,00
Current	A		0,21	0,21	0,22	0,23	0,31	0,40
Fan type			Turbo fan	Turbo fan	Turbo fan	Turbo fan	Turbo fan	Turbo fan
nanoe X Generator			Mark 3	Mark 3	Mark 3	Mark 3	Mark 3	Mark 3
Air flow	Cool (Hi/Med/Lo)	m³/min	8,5/7,0/6,0	8,7/7,0/6,0	9,0/7,5/6,0	9,5/7,8/6,0	11,5/9,0/6,5	13,5/10,5/8,0
	Heat (Hi/Med/Lo)	m³/min	8,5/7,0/6,0	8,7/7,0/6,0	9,0/7,5/6,0	9,5/7,8/6,0	11,5/9,0/6,5	13,5/10,5/8,0
Sound pressure	Hi/Med/Lo	dB(A)	33/30/28	33/30/28	34/30/28	35/31/28	39/34/30	42/37/33
Sound power	Hi/Med/Lo	dB(A)	48/45/43	48/45/43	49/45/43	50/46/43	54/49/45	57/52/48
Dimension (HxWxD) ¹⁾	Indoor	mm	243x575x575	243x575x575	243x575x575	243x575x575	243x575x575	243x575x575
	Panel	mm	30x625x625	30x625x625	30x625x625	30x625x625	30x625x625	30x625x625
Net weight		kg	17,8(15+2,8)	17,8(15+2,8)	17,8(15+2,8)	17,8(15+2,8)	17,8(15+2,8)	17,8(15+2,8)
Piping diameter	Liquid	Inch (mm)	1/4(6,35)	1/4(6,35)	1/4(6,35)	1/4(6,35)	1/4(6,35)	1/4(6,35)
	Gas	Inch (mm)	1/2(12,70)	1/2(12,70)	1/2(12,70)	1/2(12,70)	1/2(12,70)	1/2(12,70)

1) Unit height is 230mm, but need 243mm height in ceiling space for its installation. * Available in Autumn 2022.

Accessories	
CZ-RTC6W	CONEX wired remote controller (non-wireless), white
CZ-RTC6WBL	CONEX wired remote controller with Bluetooth®, white
CZ-RTC6	CONEX wired remote controller (non-wireless), black
CZ-RTC6BL	CONEX wired remote controller with Bluetooth®, black
CZ-RTC5B	Wired remote controller with Econavi function
CZ-RWS3 + CZ-RWR3	Infrared remote controller and receiver
PAW-RE2C4-MOD-WH	Room controller for hotel rooms, white

Accessories	
PAW-RE2C4-MOD-BK	Room controller for hotel rooms, black
PAW-RE2D4-WH	Display control for hotel rooms, white
PAW-RE2D4-BK	Display control for hotel rooms, black
CZ-CENSC1	Econavi energy saving sensor
CZ-CGLSC1	Panasonic R32 refrigerant leak detector
CZ-KPY4	Panel for 4 way 60x60 cassette

Technical focus

- Built-in drain pump
- DC drain pump and float switch to reduce the noise
- nanoe™ X (Generator Mark 3: 48 trillion hydroxyl radicals/sec) as standard for better indoor air quality
- Indoor unit internal cleaning with nanoe™ X plus dry operation

Compact and stylish design

- Required ceiling depth of only 250 mm ¹⁾
- Exposed area is only 30 mm

1) Installation dimension.

Individual flap control

Better control of the air flow with 4 motors, providing individual flap control.

Perfect air distribution without direct airflow, to reduce the feeling of cold drafts.

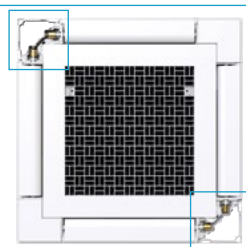

Internal cleaning function

When cooling or dry operation stopped, internal drying and nanoe™ X circulation airflow is activated in order to suppress the mould proliferation inside the unit (airflow passage, fan, heat exchanger)*.

* Depending on the installation environment or operating hours, mould proliferation or inhabitation of mould growth will be changed.

After cooling/drying operation, the inside of the indoor unit is automatically dried and nanoe™ X is activated to suppress mould growth and to reduce odour.



Operates the fan to discharge internal humidity.

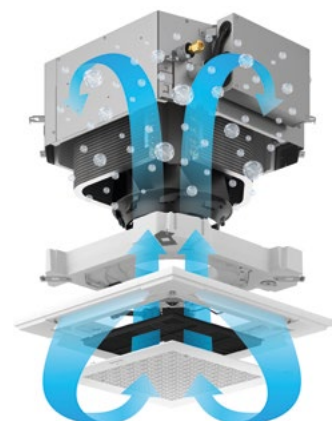

Operate the fan to circulate nanoe™ X internally.



ECONAVI and INTERNET CONTROL: Optional.

L1 type 2 way cassette - R410A

Slim, compact and lightweight units.

Remarkable size and weight reductions have been achieved by improvement of the design around the fan, the weight of all models now just 30 kg.



+ COMPATIBLE WITH ALL PANASONIC CONNECTIVITY SOLUTIONS. FOR DETAILED INFORMATION GO TO THE CONTROL SYSTEMS SECTION

Indoor unit			S-22ML1E5	S-28ML1E5	S-36ML1E5	S-45ML1E5	S-56ML1E5	S-73ML1E5
Cooling capacity		kW	2,2	2,8	3,6	4,5	5,6	7,3
Input power		W	90,00	92,00	93,00	97,00	97,00	145,00
Current		A	0,45	0,45	0,45	0,45	0,45	0,65
Heating capacity		kW	2,5	3,2	4,2	5,0	6,3	8,0
Input power		W	58,00	60,00	61,00	65,00	65,00	109,00
Current		A	0,29	0,29	0,29	0,29	0,29	0,48
Fan type			Sirocco fan	Sirocco fan	Sirocco fan	Sirocco fan	Sirocco fan	Sirocco fan
Air flow	Hi/Med/Lo	m ³ /min	8,0/7,0/6,0	9,0/8,0/7,0	9,7/8,7/7,7	11,0/9,0/8,0	11,0/9,0/8,0	19,0/16,0/14,0
Sound pressure	Hi/Med/Lo	dB(A)	30/27/24	33/29/26	34/31/28	35/33/29	35/33/29	38/35/33
Dimension (HxWxD)	Indoor	mm	350x840x600	350x840x600	350x840x600	350x840x600	350x840x600	350x1140x600
	Panel	mm	8x1060x680	8x1060x680	8x1060x680	8x1060x680	8x1060x680	8x1360x680
Net weight (Panel)		kg	26 (8)	26 (8)	26 (8)	26 (8)	26 (8)	26 (8)
Piping diameter	Liquid	Inch (mm)	1/4 (6,35)	1/4 (6,35)	1/4 (6,35)	1/4 (6,35)	1/4 (6,35)	3/8 (9,52)
	Gas	Inch (mm)	1/2 (12,70)	1/2 (12,70)	1/2 (12,70)	1/2 (12,70)	1/2 (12,70)	5/8 (15,88)

Accessories

CZ-RTC6W	CONEX wired remote controller (non-wireless), white
CZ-RTC6WBL	CONEX wired remote controller with Bluetooth®, white
CZ-RTC6	CONEX wired remote controller (non-wireless), black
CZ-RTC6BL	CONEX wired remote controller with Bluetooth®, black
CZ-RTC5B	Wired remote controller with Econavi function
CZ-RWS3 + CZ-RWRL3	Infrared remote controller and receiver

Accessories

PAW-RE2C4-MOD-WH	Room controller for hotel rooms, white
PAW-RE2C4-MOD-BK	Room controller for hotel rooms, black
PAW-RE2D4-WH	Display control for hotel rooms, white
PAW-RE2D4-BK	Display control for hotel rooms, black
CZ-02KPL2	Panel for S-22 to S-56 models
CZ-03KPL2	Panel for S-73 model

Technical focus

- Air flow and distribution is automatically altered depending on the operational mode of the unit
- Drain pump provides up to 500 mm lift height
- Simplified maintenance

Auto flap control

Air flow and distribution is automatically altered depending on the operational mode of the unit.

Simplified maintenance

The drain pan is equipped with site wiring and can be removed. The fan case has a split construction, and the fan motor can be removed easily when the lower case is removed.

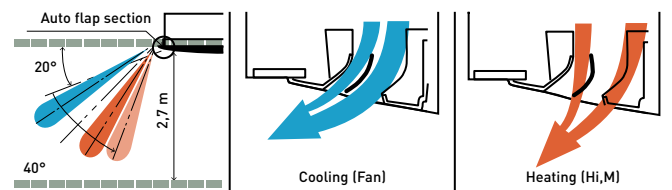

Drain pump provides up to 500 mm lift height

Maintenance of the drain pump is possible from two sides, from the left side (piping side) and from the inside of the unit.

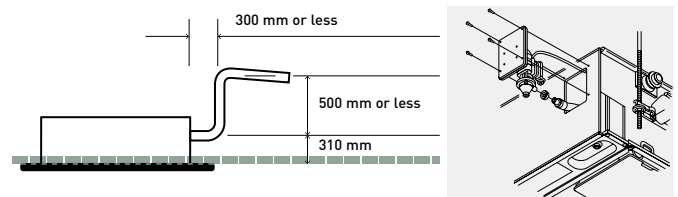

INTERNET CONTROL: Optional.

Rating conditions: Cooling indoor 27 °C DB / 19 °C WB. Cooling outdoor 35 °C DB / 24 °C WB. Heating indoor 20 °C DB. Heating outdoor 7 °C DB / 6 °C WB. (DB: Dry Bulb; WB: Wet Bulb). Specifications subject to change without notice. For detailed information about ErP / Energy Labelling, please visit our websites www.aircon.panasonic.eu or www.ptc.panasonic.eu.

D1 type 1 way cassette · R410A

Designed for installation within the ceiling void, the D1 range of slimline 1 way blow cassettes feature powerful yet quiet fans for installation of up to 4,2 m.



+ COMPATIBLE WITH ALL PANASONIC CONNECTIVITY SOLUTIONS. FOR DETAILED INFORMATION GO TO THE CONTROL SYSTEMS SECTION

Indoor unit			S-28MD1E5	S-36MD1E5	S-45MD1E5	S-56MD1E5	S-73MD1E5
Cooling capacity		kW	2,8	3,6	4,5	5,6	7,3
Input power		W	51,00	51,00	51,00	60,00	87,00
Current		A	0,39	0,39	0,39	0,46	0,70
Heating capacity		kW	3,2	4,2	5,0	6,3	8,0
Input power		W	40,00	40,00	40,00	48,00	76,00
Current		A	0,35	0,35	0,35	0,41	0,65
Fan type			Sirocco fan	Sirocco fan	Sirocco fan	Sirocco fan	Sirocco fan
Air flow	Hi/Med/Lo	m ³ /min	12,0/10,0/9,0	12,0/10,0/9,0	12,0/11,0/10,0	13,0/11,5/10,0	18,0/15,0/13,0
Sound pressure	Hi/Med/Lo	dB(A)	36/34/33	36/34/33	36/35/34	38/36/34	45/40/36
Dimension (HxWxD)	Indoor	mm	200 x 1000 x 710	200 x 1000 x 710	200 x 1000 x 710	200 x 1000 x 710	200 x 1000 x 710
	Panel	mm	20 x 1230 x 800	20 x 1230 x 800	20 x 1230 x 800	20 x 1230 x 800	20 x 1230 x 800
Net weight (Panel)		kg	23,5(7,5)	23,5(7,5)	23,5(7,5)	23,5(7,5)	24,5(7,5)
Piping diameter	Liquid	Inch (mm)	1/4(6,35)	1/4(6,35)	1/4(6,35)	1/4(6,35)	3/8(9,52)
	Gas	Inch (mm)	1/2(12,70)	1/2(12,70)	1/2(12,70)	1/2(12,70)	5/8(15,88)

Accessories

CZ-RTC6W	CONEX wired remote controller (non-wireless), white
CZ-RTC6WBL	CONEX wired remote controller with Bluetooth®, white
CZ-RTC6	CONEX wired remote controller (non-wireless), black
CZ-RTC6BL	CONEX wired remote controller with Bluetooth®, black
CZ-RTC5B	Wired remote controller with Econavi function
CZ-RWS3 + CZ-RWRD3	Infrared remote controller and receiver

Accessories

PAW-RE2C4-MOD-WH	Room controller for hotel rooms, white
PAW-RE2C4-MOD-BK	Room controller for hotel rooms, black
PAW-RE2D4-WH	Display control for hotel rooms, white
PAW-RE2D4-BK	Display control for hotel rooms, black
CZ-KPD2	Panel

Technical focus

- Ultra-Slim
- Suitable for standard and high ceilings
- Built-in drain pump provides 590 mm lift
- Easy to install and maintain
- Hanging height can be easily adjusted
- Uses a DC fan motor to improve energy-efficiency

Drain height

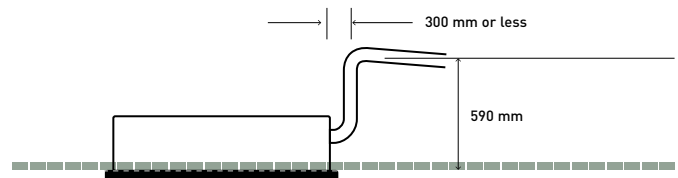

With 3 types of air-blow systems, the units can be used in various ways

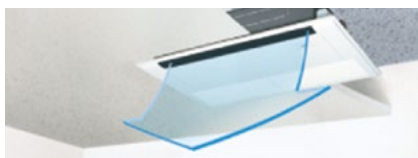

1. One-direction "down-blow" system.
Powerful one-direction "down-blow" system reaches the floor even from high ceilings (up to 4,2 m).



2. Two-direction ceiling-mounted system.
"Down-blow" and "front-blow" systems are combined in a ceiling-mounted unit to blow air over a wide area.



3. One-direction ceiling-mounted system.
This powerful ceiling-mounted "front-blow" system efficiently air-conditions the space in front of the unit. [Additional accessories required].



INTERNET CONTROL: Optional.

New F3 type variable static pressure adaptive duct · R32 / R410A

Design adaptive ducted F3 range.

2 installation possibilities (horizontal / vertical) with high ESP 150 Pa allows for flexible installation.



New 2023



+ COMPATIBLE WITH ALL PANASONIC CONNECTIVITY SOLUTIONS. FOR DETAILED INFORMATION GO TO THE CONTROL SYSTEMS SECTION

NEW R32 unit. S-***MF3E5BN		15	22	28	36	45	56	60	73	90	—	112	140	160	
NEW R410A unit. S-***MF3E5AN															
nanoe X Generator		Mark 3	Mark 3	Mark 3	Mark 3	Mark 3	Mark 3	Mark 3	Mark 3	Mark 3	—	Mark 3	Mark 3	Mark 3	
R32 unit. S-***MF3E5B		15	22	28	36	45	56	60	73	90	106	—	140	160	
R410A unit. S-***MF3E5A															
nanoe X Generator		Mark 2	Mark 2	Mark 2	Mark 2	Mark 2	Mark 2	Mark 2	Mark 2	Mark 2	Mark 2	—	Mark 2	Mark 2	
Cooling capacity	kW	1,5	2,2	2,8	3,6	4,5	5,6	6,0	7,3	9,0	10,6	11,2	14,0	16,0	
Input power	W	60,00	60,00	60,00	60,00	60,00	89,00	79,00	79,00	136,00	146,00	265,00	265,00	330,00	
Current	A	0,45	0,45	0,45	0,45	0,45	0,63	0,52	0,52	0,90	1,00	1,76	1,76	2,14	
Heating capacity	kW	1,7	2,5	3,2	4,2	5,0	6,3	7,1	8,0	10,0	11,4	12,5	16,0	18,0	
Input power	W	60,00	60,00	60,00	60,00	60,00	89,00	79,00	79,00	136,00	146,00	265,00	265,00	330,00	
Current	A	0,45	0,45	0,45	0,45	0,45	0,63	0,52	0,52	0,90	1,00	1,76	1,76	2,14	
R32 leakage sensors ¹⁾		2	2	2	2	2	2	2	2	2	2	2	2	2	
Fan type		Sirocco fan	Sirocco fan	Sirocco fan	Sirocco fan	Sirocco fan	Sirocco fan	Sirocco fan	Sirocco fan	Sirocco fan	Sirocco fan	Sirocco fan	Sirocco fan	Sirocco fan	
External static pressure	Pa	30 (10-150)	30 (10-150)	30 (10-150)	30 (10-150)	30 (10-150)	30 (10-150)	30 (10-150)	30 (10-150)	30 (10-150)	40 (10-150)	40 (10-150)	50 (10-150)	50 (10-150)	
Air flow ²⁾	Hi/ Med/ Lo	m ³ /min	128 ³⁾ / 11,0 ³⁾ /8,0 ³⁾	128 ³⁾ / 11,0 ³⁾ /8,0 ³⁾	14,0/12,0/ 8,0	14,0/12,0/ 8,0	14,0/12,0/ 8,0	16,0/14,0/ 10,0	21,0/18,0/ 15,0	21,0/18,0/ 15,0	25,0/23,0/ 16,0	32,0/26,0/ 21,0	37,0/32,0/ 26,0	37,0/32,0/ 26,0	40,0/34,0/ 28,0
Sound pressure	Hi/ Med/ Lo	dB(A)	31/28/20	31/28/20	31/28/20	31/28/20	31/28/20	35/32/24	31/28/23	31/28/23	35/33/25	36/32/27	41/36/32	41/36/32	43/37/33
Sound power		dB(A)	54/51/43	54/51/43	54/51/43	54/51/43	54/51/43	58/55/47	54/51/46	54/51/46	58/56/48	59/55/50	64/59/55	64/59/55	66/60/56
Dimension (H x W x D)		mm	250 x 800 x 730	250 x 800 x 730	250 x 800 x 730	250 x 800 x 730	250 x 800 x 730	250 x 800 x 730	250 x 1000 x 730	250 x 1000 x 730	250 x 1000 x 730	250 x 1400 x 730	250 x 1400 x 730	250 x 1400 x 730	
Net weight		kg	26	26	26	26	26	26	31	31	31	40	40	40	
Piping diameter	Liquid	Inch (mm)	1/4 (6,35)	1/4 (6,35)	1/4 (6,35)	1/4 (6,35)	1/4 (6,35)	1/4 (6,35)	1/4 (6,35)	1/4 (6,35)	1/4 (6,35)	3/8 (9,52)	3/8 (9,52)	3/8 (9,52)	3/8 (9,52)
R32 model	Gas	Inch (mm)	1/2 (12,70)	1/2 (12,70)	1/2 (12,70)	1/2 (12,70)	1/2 (12,70)	1/2 (12,70)	1/2 (12,70)	1/2 (12,70)	1/2 (12,70)	5/8 (15,88)	5/8 (15,88)	5/8 (15,88)	5/8 (15,88)
Piping diameter	Liquid	Inch (mm)	1/4 (6,35)	1/4 (6,35)	1/4 (6,35)	1/4 (6,35)	1/4 (6,35)	1/4 (6,35)	3/8 (9,52)	3/8 (9,52)	3/8 (9,52)	3/8 (9,52)	3/8 (9,52)	3/8 (9,52)	3/8 (9,52)
R410A model	Gas	Inch (mm)	1/2 (12,70)	1/2 (12,70)	1/2 (12,70)	1/2 (12,70)	1/2 (12,70)	1/2 (12,70)	5/8 (15,88)	5/8 (15,88)	5/8 (15,88)	5/8 (15,88)	5/8 (15,88)	5/8 (15,88)	5/8 (15,88)

1) Only available in the R32 version. 2) Value referred to standard settings at shipment (H curve 8, M curve 5, L curve 1). 3) The data for S-***MF3E5B and S-***MF3E5A is different. Please refer the technical manual.

Accessories	
CZ-RTC6W	CONEX wired remote controller (non-wireless), white
CZ-RTC6WBL	CONEX wired remote controller with Bluetooth®, white
CZ-RTC6	CONEX wired remote controller (non-wireless), black
CZ-RTC6BL	CONEX wired remote controller with Bluetooth®, black
CZ-RTC5B	Wired remote controller with Econavi function
CZ-RWS3 + CZ-RWRC3	Infrared remote controller and receiver

Accessories	
PAW-RE2C4-MOD-WH	Room controller for hotel rooms, white
PAW-RE2C4-MOD-BK	Room controller for hotel rooms, black
PAW-RE2D4-WH	Display control for hotel rooms, white
PAW-RE2D4-BK	Display control for hotel rooms, black
CZ-CENSC1	Econavi energy saving sensor

Technical focus

- 4 installation possibilities with horizontal and vertical mounting, plus selectable rear or bottom air inlet
- Industry leading low noise with super quiet operation, minimum 20 dB(A)
- Only 250 mm height and lightweight unit from, 26 to 40 kg
- Integrated Panasonic R32 refrigerant leak detectors ¹⁾
- Improved drain pan suitable for both horizontal / vertical installation
- Drain pump included ²⁾
- nanoe™ X as standard. MF3E5BN: Generator Mark 3: 48 trillion hydroxyl radicals/sec. MF3E5B: Generator Mark 2: 9,6 trillion hydroxyl radicals/sec, effective even with duct connections up to 10 m with 3 x 90° bends ³⁾

1) Only available in the R32 version. 2) For use with horizontal installation only. 3) Panasonic internal survey.

Vertical Installation

Vertical installation option. Variable external static pressure to support ducted installations with bends.

* Vertical installation requires additional settings on field, please check the installation manual.



Improved drain pan design

Drain pan is shared in both cases horizontal and vertical installation. No need to modify the unit.

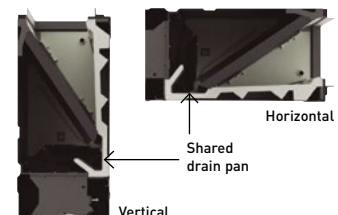

ECONAVI and INTERNET CONTROL: Optional.

F2 type variable static pressure hide-away · R410A

The F2 type is designed specifically for applications requiring fixed square ducting.

The internal mesh filter is equipped as standard.



+ COMPATIBLE WITH ALL PANASONIC CONNECTIVITY SOLUTIONS. FOR DETAILED INFORMATION GO TO THE CONTROL SYSTEMS SECTION

Indoor unit	S . MF2E5A	15	22	28	36	45	56	60	73	90	106	140	160	
Cooling capacity	kW	1,5	2,2	2,8	3,6	4,5	5,6	6,0	7,3	9,0	10,6	14,0	16,0	
Input power	W	70,00	70,00	70,00	70,00	70,00	100,00	120,00	120,00	135,00	195,00	215,00	225,00	
Current	A	0,57	0,57	0,57	0,57	0,57	0,74	0,89	0,89	0,97	1,30	1,44	1,50	
Heating capacity	kW	1,7	2,5	3,2	4,2	5,0	6,3	7,1	8,0	10,0	11,4	16,0	18,0	
Input power	W	70,00	70,00	70,00	70,00	70,00	100,00	120,00	120,00	135,00	200,00	210,00	225,00	
Current	A	0,57	0,57	0,57	0,57	0,57	0,74	0,89	0,89	0,97	1,34	1,42	1,50	
Fan type		Sirocco fan	Sirocco fan	Sirocco fan	Sirocco fan	Sirocco fan	Sirocco fan	Sirocco fan	Sirocco fan	Sirocco fan	Sirocco fan	Sirocco fan	Sirocco fan	
Air flow ¹⁾	Hi/Med/Lo	m ³ /min	14,0/13,0/9,0	14,0/13,0/9,0	14,0/13,0/9,0	14,0/13,0/9,0	14,0/13,0/10,0	16,0/15,0/12,0	21,0/19,0/15,0	21,0/19,0/15,0	25,0/23,0/19,0	32,0/26,0/21,0	34,0/29,0/23,0	36,0/32,0/25,0
External static pressure	Pa		70(10-150)	70(10-150)	70(10-150)	70(10-150)	70(10-150)	70(10-150)	70(10-150)	70(10-150)	100(10-150)	100(10-150)	100(10-150)	
Sound pressure	Hi/Med/Lo	dB(A)	33/29/22	33/29/22	33/29/22	33/29/22	34/32/25	34/32/25	35/32/26	35/32/26	37/34/28	38/34/31	39/35/32	40/36/33
Sound power	Hi/Med/Lo	dB(A)	55/51/44	55/51/44	55/51/44	55/51/44	56/54/47	56/54/47	57/54/48	57/54/48	59/56/50	60/56/53	61/57/54	62/58/55
Dimension	HxWxD	mm	290x800x700	290x800x700	290x800x700	290x800x700	290x800x700	290x800x700	290x1000x700	290x1000x700	290x1000x700	290x1400x700	290x1400x700	
Net weight	kg		29	29	29	29	29	29	34	34	34	46	46	46
Piping diameter	Liquid	Inch (mm)	1/4(6,35)	1/4(6,35)	1/4(6,35)	1/4(6,35)	1/4(6,35)	1/4(6,35)	3/8(9,52)	3/8(9,52)	3/8(9,52)	3/8(9,52)	3/8(9,52)	
	Gas	Inch (mm)	1/2(12,70)	1/2(12,70)	1/2(12,70)	1/2(12,70)	1/2(12,70)	1/2(12,70)	5/8(15,88)	5/8(15,88)	5/8(15,88)	5/8(15,88)	5/8(15,88)	

1) Value referred to standard settings at shipment (H curve 8, M curve 5, L curve 1).

Accessories

CZ-RTC6W	CONEX wired remote controller (non-wireless), white
CZ-RTC6WBL	CONEX wired remote controller with Bluetooth®, white
CZ-RTC6	CONEX wired remote controller (non-wireless), black
CZ-RTC6BL	CONEX wired remote controller with Bluetooth®, black
CZ-RTC5B	Wired remote controller with Econavi function
CZ-RWS3 + CZ-RWRC3	Infrared remote controller and receiver

Accessories

PAW-RE2C4-MOD-WH	Room controller for hotel rooms, white
PAW-RE2C4-MOD-BK	Room controller for hotel rooms, black
PAW-RE2D4-WH	Display control for hotel rooms, white
PAW-RE2D4-BK	Display control for hotel rooms, black
CZ-CENS1	Econavi energy saving sensor

Technical focus

- Industry-leading low sound levels from 25 dB(A)
- Built-in drain pump provides 700 mm lift
- Easy to install and maintain
- Air OFF sensor avoids cold air dumping
- Configurable air temperature control

More powerful drain pump

Using a high-lift drain pump, drain piping can be elevated to 700 mm from the base of the unit.

Air inlet plenum	Dampers diameters	Reference
15, 22, 28, 36, 45 and 56	2 x Ø200	CZ-DUMPA56MF2
60, 73 and 90	3 x Ø200	CZ-DUMPA90MF2
106, 140 and 160	4 x Ø200	CZ-DUMPA160MF2

F2 Advantages

Automatic learning function for the required static pressure, to be activated easily by the standard wired timer remote controller. Possible to increase the sensible cooling capacity by adjusting the air flow in order to almost completely eliminate latent losses. This is possible due to the outstanding heat exchanger surface in combination with increasing the air flow by a manual selection of higher fan speed. This is achieved through the standard wired remote controller when commissioning the system, together with the default active off-coil temperature control and the room load based variable evaporation temperature control.

Diagram 1 S-22MF2E5A

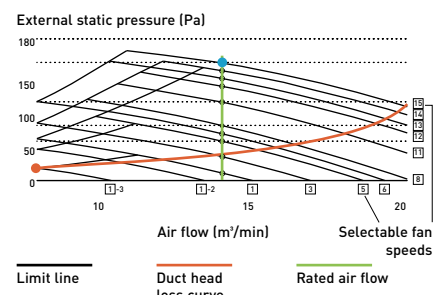

ECONAVI and INTERNET CONTROL: Optional.

M1 type slim variable static pressure hide-away concealed duct · R32 / R410A

The ultra slim M1 type is one of the leading products of its type in the industry.

With a depth of only 200 mm it provides greater flexibility and can be used in far more applications.



+ COMPATIBLE WITH ALL PANASONIC CONNECTIVITY SOLUTIONS. FOR DETAILED INFORMATION GO TO THE CONTROL SYSTEMS SECTION

Indoor unit			S-15MM1E5B	S-22MM1E5B	S-28MM1E5B	S-36MM1E5B	S-45MM1E5B	S-56MM1E5B
Cooling capacity		kW	1,5	2,2	2,8	3,6	4,5	5,6
Input power		W	36,00	36,00	40,00	42,00	49,00	64,00
Current		A	0,26	0,26	0,30	0,31	0,37	0,48
Heating capacity		kW	1,7	2,5	3,2	4,2	5,0	6,3
Input power		W	26,00	26,00	30,00	32,00	39,00	54,00
Current		A	0,23	0,23	0,27	0,28	0,34	0,45
Fan type			Sirocco fan	Sirocco fan	Sirocco fan	Sirocco fan	Sirocco fan	Sirocco fan
Air flow	Hi/Med/Lo	m ³ /min	8,0/7,0/6,0	8,0/7,0/6,0	8,5/7,5/6,5	9,0/8,0/7,0	10,5/9,5/8,0	12,5/11,5/10,0
External static pressure		Pa	10(30)	10(30)	15(30)	15(40)	15(40)	15(40)
Sound pressure	Hi/Med/Lo ¹⁾	dB(A)	28/27/25 (30/29/27)	28/27/25 (30/29/27)	30/29/27 (32/31/29)	32/30/28 (34/32/30)	34/32/30 (36/34/32)	35/33/31 (37/35/32)
Sound power	Hi/Med/Lo	dB(A)	43/42/40	43/42/40	45/44/42	47/45/43	49/47/45	50/48/46
Dimension	H x W x D	mm	200 x 750 x 640	200 x 750 x 640	200 x 750 x 640	200 x 750 x 640	200 x 750 x 640	200 x 750 x 640
Net weight		kg	19	19	19	19	19	19
Piping diameter	Liquid	Inch (mm)	1/4(6,35)	1/4(6,35)	1/4(6,35)	1/4(6,35)	1/4(6,35)	1/4(6,35)
	Gas	Inch (mm)	1/2(12,70)	1/2(12,70)	1/2(12,70)	1/2(12,70)	1/2(12,70)	1/2(12,70)

1) By DIP switches or by RC setting.

Accessories

CZ-RTC6W	CONEX wired remote controller (non-wireless), white
CZ-RTC6WBL	CONEX wired remote controller with Bluetooth®, white
CZ-RTC6	CONEX wired remote controller (non-wireless), black
CZ-RTC6BL	CONEX wired remote controller with Bluetooth®, black
CZ-RTC5B	Wired remote controller with Econavi function
CZ-RWS3 + CZ-RWRC3	Infrared remote controller and receiver

Accessories

PAW-RE2C4-MOD-WH	Room controller for hotel rooms, white
PAW-RE2C4-MOD-BK	Room controller for hotel rooms, black
PAW-RE2D4-WH	Display control for hotel rooms, white
PAW-RE2D4-BK	Display control for hotel rooms, black
CZ-CENSC1	Econavi energy saving sensor
CZ-CGLSC1	Panasonic R32 refrigerant leak detector

Technical focus

- Ultra-slim profile: 200 mm for all models
- DC fan motor greatly reduces power consumption
- Ideal for hotel application with very narrow false ceilings
- Easy maintenance and service by external electrical box

- Up to 40 Pa static pressure enables ductwork to be fitted
- Includes drain pump

In addition, its high-efficiency and extremely quiet sound levels make it very popular with many users, including hotels and small offices.

Air outlet and inlet plenum

	Diameters	Air outlet plenum	Diameters	Air inlet plenum
22, 28 and 36	2 x Ø200	CZ-DUMPA22MMS2	2 x Ø200	CZ-DUMPA22MMR2
45 and 56	3 x Ø160	CZ-DUMPA45MMS3		

* Plenums installed with an R32 Mini ECOi system may only be used when no Panasonic R32 refrigerant leak detector is required. Please refer to technical data manual for refrigerant installation requirements.

Ultra-slim profile for all models

200 mm

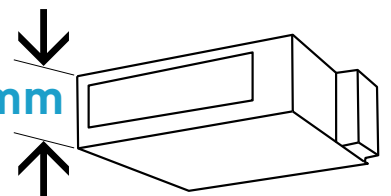

Drain pump with increased power!

By adoption of a high-lift drain pump, the drain piping can achieve up to 500 mm lift from the outlet port of the unit.

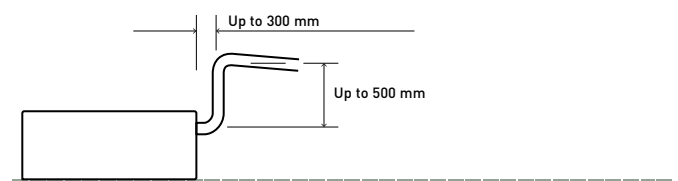

ECONAVI and INTERNET CONTROL: Optional.

Rating conditions: Cooling indoor 27 °C DB / 19 °C WB. Cooling outdoor 35 °C DB / 24 °C WB. Heating indoor 20 °C DB. Heating outdoor 7 °C DB / 6 °C WB. (DB: Dry Bulb; WB: Wet Bulb). Specifications subject to change without notice. For detailed information about ErP / Energy Labelling, please visit our websites www.aircon.panasonic.eu or www.ptc.panasonic.eu.

E2 type high static pressure hide-away · R410A

High pressure duct and 100% Fresh air duct function.

The E2 range of ducted units offers improved design flexibility for extended duct layouts as a result of their increased external static pressures whilst reducing energy consumption.



+ COMPATIBLE WITH ALL PANASONIC CONNECTIVITY SOLUTIONS. FOR DETAILED INFORMATION GO TO THE CONTROL SYSTEMS SECTION

Type	100% Fresh air duct function (by using Kit for 100% fresh air)				High pressure duct					
	S-224ME2E5		S-280ME2E5		S-224ME2E5		S-280ME2E5			
Indoor unit		Cooling	Heating	Cooling	Heating	Cooling	Heating	Cooling	Heating	
Capacity	kW	22,4	21,2	28,0	26,5	22,4	25,0	28,0	31,5	
Input power	W	290,00	290,00	350,00	350,00	440,00	440,00	715,00	715,00	
Current	A	1,85	1,85	2,20	2,20	2,45	2,45	3,95	3,95	
Air flow	Hi/Med/Lo	m ³ /min 28,3/—/—		35,0/—/—		56,0/51,0/44,0		72,0/63,0/53,0		
External static pressure	Pa	200		200		140 [60 - 270] ¹⁾		140 [72 - 270] ¹⁾		
Sound pressure ²⁾	Hi/Med/Lo	dB(A) 43/—/—		44/—/—		45/43/41		49/47/43		
Sound power	Hi/Med/Lo	dB(A) 75/—/—		76/—/—		77/75/73		81/79/75		
Dimension	HxWxD	mm 479 x 1453 x 1205		479 x 1453 x 1205		479 x 1453 x 1205		479 x 1453 x 1205		
Net weight	kg	102		106		102		106		
Piping diameter	Liquid	Inch (mm)	3/8 (9,52)		3/8 (9,52)		3/8 (9,52)		3/8 (9,52)	
	Gas	Inch (mm)	3/4 (19,05)		7/8 (22,22)		3/4 (19,05)		7/8 (22,22)	

Rating Conditions for 100% Fresh air duct function: Cooling Outdoor 33 °C DB / 28 °C WB. Heating Outdoor 0 °C DB / -2,9 °C WB.

1) Available to select the setting by initial setup. 2) Values with 140 Pa setting. * No filter included. ** No compatible with 3-Pipe ECO G GF3.

Accessories	
CZ-RTC6W	CONEX wired remote controller (non-wireless), white
CZ-RTC6WBL	CONEX wired remote controller with Bluetooth®, white
CZ-RTC6	CONEX wired remote controller (non-wireless), black
CZ-RTC6BL	CONEX wired remote controller with Bluetooth®, black
CZ-RTC5B	Wired remote controller with Econavi function
CZ-RWS3 + CZ-RWRC3	Infrared remote controller and receiver

Accessories	
PAW-RE2C4-MOD-WH	Room controller for hotel rooms, white
PAW-RE2C4-MOD-BK	Room controller for hotel rooms, black
PAW-RE2D4-WH	Display control for hotel rooms, white
PAW-RE2D4-BK	Display control for hotel rooms, black
CZ-CENSC1	Econavi energy saving sensor

Technical focus

- No need of rap valves for standard operation
- 100% fresh air duct function*
- DC fan motor for more savings
- Complete flexibility for ductwork design
- Can be located within a weatherproof housing for external installation
- Air OFF sensor avoids cold air dumping
- Configurable air temperature control

* Rap valves required, see 100% fresh air duct function below.

100% fresh air duct function

The E2 duct with 100% fresh air duct function have exceptional discharge temperature.

	Discharge Range		
	Min	Max	Default
Cooling	15 °C	24 °C	18 °C
Heating	17 °C	45 °C	40 °C

System example

An inspection port (450 x 450 mm or more) is required at the lower side of the indoor unit body (field supply).

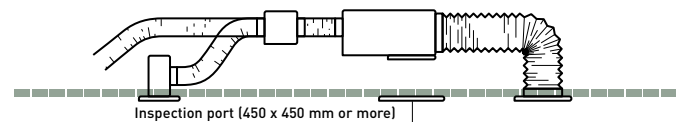

Plenums

Air outlet plenum (suitable for rigid + flexible duct)		
	Number of exits with diameters	Model
S-224ME2E5	1 x 500 mm	CZ-TREMIESPW05
S-280ME2E5	1 x 500 mm	CZ-TREMIESPW06

Kit for 100% fresh air function

Kit for 2 way systems		Kit for 3 way systems	
2x CZ-P160RVK2	Rap valve kit	2x CZ-P160HR3	3 way valve kit
2x CZ-CAPE2	3 way control PCB	2x CZ-CAPE2	3 way control PCB
CZ-P680BK2BM	Distribution joint kit	CZ-P680BH2BM	Distribution joint kit
	1x remote controller		1x remote controller



ECONAVI and INTERNET CONTROL: Optional.

Heat recovery with DX coil - R410A

Motorised heat recovery by-pass device automatically controlled to use fresh air free-cooling when convenient.



+ COMPATIBLE WITH ALL PANASONIC CONNECTIVITY SOLUTIONS. FOR DETAILED INFORMATION GO TO THE CONTROL SYSTEMS SECTION

Indoor unit			PAW-500ZDX3N		PAW-800ZDX3N		PAW-01KZDX3N	
Power supply	Voltage	V	230		230		230	
	Phase		Single phase		Single phase		Single phase	
	Frequency	Hz	50		50		50	
Air flow		m ³ /min	8,3		13,3		16,7	
External static pressure ¹⁾		Pa	90		120		115	
Maximum current	Total full load	A	0,6		1,4		2,1	
		W	150		320		390	
Sound pressure ²⁾		dB(A)	39		42		43	
Piping diameter	Liquid	Inch (mm)	1/4 (6,35)		1/4 (6,35)		1/4 (6,35)	
	Gas	Inch (mm)	1/2 (12,70)		1/2 (12,70)		1/2 (12,70)	
Heat recovery			Cooling	Heating	Cooling	Heating	Cooling	Heating
Temperature efficiency	%		76	76	76	76	76	76
Enthalpy efficiency	%		63	67	63	65	60	62
Saved power summer mode or winter mode*	kW		1,70	4,30 (4,80)	2,50	6,50 (7,30)	3,20	8,20 (9,00)
DX coil								
Total / Sensible capacity	kW		3,00/2,10	2,50/2,70	5,10/3,50	4,40/4,80	5,80/4,10	5,20/6,70
OFF temperature	°C		15,9	28,0 (27,3)	15,5	29,6 (29,0)	16,2	28,5 (27,8)
OFF relative humidity	%		90	16 (15)	90	14 (13)	89	15 (14)

Nominal summer conditions: Outside air: 32 °C DB, RH 50%. Ambient air: 26 °C DB, RH 50%. Nominal winter conditions: Outside air: -5 °C DB, RH 80%. Ambient air: 20 °C DB, RH 50%. Cooling mode air inlet condition: 28,5 °C DB, RH 50%; evaporating temperature 7 °C. Heating mode air inlet condition: 13 °C DB, RH 40% (11 °C DB, RH 45%); condensating temperature 40 °C. DB: Dry Bulb; RH: Relative Humidity. 1) Referred to the nominal air flow after filter and plate heat exchanger. 2) Sound pressure level calculated at 1 m far from: ducted supply exhaust air ducted return - first air intake / service side, at normal condition. * Tentative data.

Accessories	
CZ-RTC6W	CONEX wired remote controller (non-wireless), white
CZ-RTC6WBL	CONEX wired remote controller with Bluetooth®, white
CZ-RTC6	CONEX wired remote controller (non-wireless), black
CZ-RTC6BL	CONEX wired remote controller with Bluetooth®, black
CZ-RTC5B	Wired remote controller with Econavi function

Accessories	
PAW-RE2C4-MOD-WH	Room controller for hotel rooms, white
PAW-RE2C4-MOD-BK	Room controller for hotel rooms, black
PAW-RE2D4-WH	Display control for hotel rooms, white
PAW-RE2D4-BK	Display control for hotel rooms, black

Technical focus

- Galvanized steel self-supporting panels, internally and externally insulated
- High efficiency static cross-flow heat recovery, made by membrane with high moisture permeability, good air tightness, excellent tear, and aging resistance, structure consisting of flat and corrugated plates. Total heat exchange with temperature efficiency up to 76% and enthalpy efficiency up to 67%, also at high level during summer season
- ISO16890 ePm2,5 95% (F9 EN 779) efficiency class filter with synthetic cleanable media and COARSE 50% (G3 EN 779) pre-filter ON fresh air, COARSE 50% filter on return air intake
- Removable side panel to access filters and heat recovery in the event of scheduled maintenance
- Low consumption, low noise, high efficiency direct driven fans

- Supply section complete with DX coil (R410A) fitted with solenoid control valve, freon filter, contact temperature sensors on liquid and gas line, NTC sensors upstream and downstream of air flow
- Built-in electric box equipped with PCB to control internal fan speed and to interconnect outdoor / indoor units
- Duct connection by circular plastic collars

Balanced ventilation

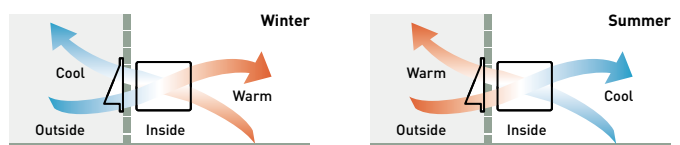

Interconnection to outdoor / indoor units

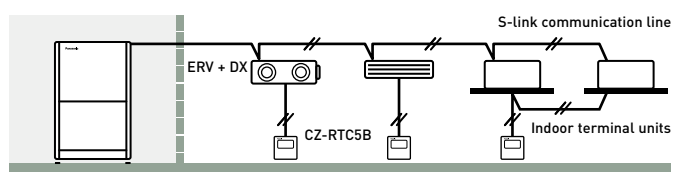

INTERNET CONTROL: Optional.

Rating conditions: Cooling indoor 27 °C DB / 19 °C WB. Cooling outdoor 35 °C DB / 24 °C WB. Heating indoor 20 °C DB. Heating outdoor 7 °C DB / 6 °C WB. (DB: Dry Bulb; WB: Wet Bulb). Specifications subject to change without notice. For detailed information about ErP / Energy Labelling, please visit our websites www.aircon.panasonic.eu or www.ptc.panasonic.eu.

T2 type ceiling · R410A

The T2 type ceiling mounted units feature a DC fan motor for increased efficiency and reduced operating sound levels.

All the units are the same height and depth for a uniform appearance in mixed installations, and feature a fresh air knockout for improved air quality.



+ COMPATIBLE WITH ALL PANASONIC CONNECTIVITY SOLUTIONS. FOR DETAILED INFORMATION GO TO THE CONTROL SYSTEMS SECTION

Indoor unit			S-36MT2E5A	S-45MT2E5A	S-56MT2E5A	S-73MT2E5A	S-106MT2E5A	S-140MT2E5A
Cooling capacity	kW		3,6	4,5	5,6	7,3	10,6	14,0
Input power	W		35,00	40,00	40,00	55,00	80,00	100,00
Current	A		0,36	0,38	0,38	0,44	0,67	0,79
Heating capacity	kW		4,2	5,0	6,3	8,0	11,4	16,0
Input power	W		35,00	40,00	40,00	55,00	80,00	100,00
Current	A		0,36	0,38	0,38	0,44	0,67	0,79
Fan type			Sirocco fan	Sirocco fan	Sirocco fan	Sirocco fan	Sirocco fan	Sirocco fan
Air flow	Hi/Med/Lo	m ³ /min	14,0/12,0/10,5	15,0/12,5/10,5	15,0/12,5/10,5	21,0/18,0/15,5	30,0/25,0/23,0	32,0/28,0/24,0
Sound pressure	Hi/Med/Lo	dB(A)	36/32/30	37/33/30	37/33/30	39/35/33	42/37/36	46/40/37
Sound power	Hi/Med/Lo	dB(A)	54/50/48	55/51/48	55/51/48	57/53/51	60/55/54	62/58/55
Dimension	HxWxD	mm	235x960x690	235x960x690	235x960x690	235x1275x690	235x1590x690	235x1590x690
Net weight		kg	27	27	27	33	40	40
Piping diameter	Liquid	Inch (mm)	1/4(6,35)	1/4(6,35)	1/4(6,35)	3/8(9,52)	3/8(9,52)	3/8(9,52)
	Gas	Inch (mm)	1/2(12,70)	1/2(12,70)	1/2(12,70)	5/8(15,88)	5/8(15,88)	5/8(15,88)

Accessories

CZ-RTC6W	CONEX wired remote controller (non-wireless), white
CZ-RTC6WBL	CONEX wired remote controller with Bluetooth®, white
CZ-RTC6	CONEX wired remote controller (non-wireless), black
CZ-RTC6BL	CONEX wired remote controller with Bluetooth®, black
CZ-RTC5B	Wired remote controller with Econavi function
CZ-RWS3 + CZ-RWRT3	Infrared remote controller and receiver

Accessories

PAW-RE2C4-MOD-WH	Room controller for hotel rooms, white
PAW-RE2C4-MOD-BK	Room controller for hotel rooms, black
PAW-RE2D4-WH	Display control for hotel rooms, white
PAW-RE2D4-BK	Display control for hotel rooms, black
CZ-CENSC1	Econavi energy saving sensor

Technical focus

- Low sound levels
- All units just 235 mm high
- Large and wide air distribution
- Easy to install and maintain
- Fresh air knockout

Air distribution is altered depending on the operational mode

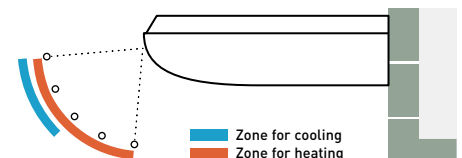

Further comfort improvement with air flow distribution

Horizontal air flow reaches maximum 9,5 m. This is ideal for wide rooms.

The wide air discharge opening expands the air flow to the left and right. The unpleasant feeling caused when the air flow directly hits the human body is prevented by the "Draft prevention position", which changes the swing width, increasing the degree of comfort.

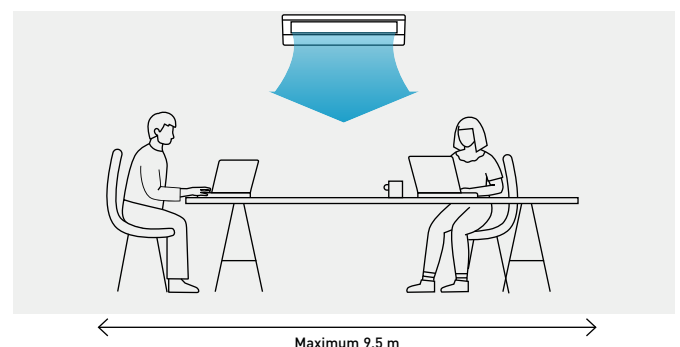

ECONAVI and INTERNET CONTROL: Optional.

K2 type wall-mounted · R32 / R410A

The wall-mounted unit has a stylish smooth panel that looks good and is easy to clean.

The unit is also smaller, lighter and substantially quieter than previous models making it ideal for small offices and other commercial applications.



+ COMPATIBLE WITH ALL PANASONIC CONNECTIVITY SOLUTIONS. FOR DETAILED INFORMATION GO TO THE CONTROL SYSTEMS SECTION

Indoor unit			S-15MK2E5B	S-22MK2E5B	S-28MK2E5B	S-36MK2E5B	S-45MK2E5B	S-56MK2E5B	S-73MK2E5B	S-106MK2E5B
Cooling capacity	kW		1,5	2,2	2,8	3,6	4,5	5,6	7,3	10,6
Input power	W		25,00	25,00	25,00	30,00	30,00	35,00	55,00	80,00
Current	A		0,20	0,21	0,23	0,25	0,32	0,35	0,51	0,70
Heating capacity	kW		1,7	2,5	3,2	4,2	5,0	6,3	8,0	11,4
Input power	W		25,00	25,00	25,00	30,00	30,00	35,00	55,00	80,00
Current	A		0,20	0,21	0,23	0,25	0,32	0,35	0,51	0,70
Fan type			Cross flow	Cross flow	Cross flow	Cross flow	Cross flow	Cross flow	Cross flow	Cross flow
Air flow	Cool (Hi/Med/Lo)	m ³ /min	7,9/7,4/6,5	9,0/7,5/6,5	9,5/8,3/6,5	10,9/9,0/6,5	14,5/12,5/10,0	16,0/14,0/12,0	19,5/17,0/14,0	21,5/18,5/15,0
	Heat (Hi/Med/Lo)	m ³ /min	9,0/7,7/6,8	9,2/8,3/6,8	9,7/8,5/6,8	11,2/9,5/6,8	14,5/12,5/10,0	16,0/14,0/12,0	19,5/17,0/14,0	21,5/18,5/15,0
Sound pressure	Hi/Med/Lo	dB(A)	34/32/29	36/33/29	37/34/29	40/36/29	38/35/33	40/37/35	47/44/40	49/46/42
Sound power	Hi/Med/Lo	dB(A)	49/47/44	51/48/44	52/49/44	55/51/44	53/50/48	55/52/50	62/59/55	64/61/57
Dimension	HxWxD	mm	290x870 x214	290x870 x214	290x870 x214	290x870 x214	302x1120 x236	302x1120 x236	302x1120 x236	302x1120 x236
Net weight	kg		9	9	9	9	13	13	14	14
Piping diameter	Liquid	Inch (mm)	1/4(6,35)	1/4(6,35)	1/4(6,35)	1/4(6,35)	1/4(6,35)	1/4(6,35)	3/8(9,52) ¹⁾	3/8(9,52)
	Gas	Inch (mm)	1/2(12,70)	1/2(12,70)	1/2(12,70)	1/2(12,70)	1/2(12,70)	1/2(12,70)	5/8(15,88) ¹⁾	5/8(15,88)

1) When the piping diameter is (liquid) Ø1/4 (6,35) - (gas) Ø1/2 (12,70), connect the liquid socket tube (Ø1/4 (6,35) - Ø3/8 (9,52)) to the liquid tubing side indoor unit and connect the gas socket tube (Ø1/2 (12,70) - Ø5/8 (15,88)) to the gas tubing side indoor unit.

Accessories

CZ-RTC6W	CONEX wired remote controller (non-wireless), white
CZ-RTC6WBL	CONEX wired remote controller with Bluetooth®, white
CZ-RTC6	CONEX wired remote controller (non-wireless), black
CZ-RTC6BL	CONEX wired remote controller with Bluetooth®, black
CZ-RTC5B	Wired remote controller with Econavi function
CZ-RWS3	Infrared remote controller
PAW-RE2C4-MOD-WH	Room controller for hotel rooms, white

Accessories

PAW-RE2C4-MOD-BK	Room controller for hotel rooms, black
PAW-RE2D4-WH	Display control for hotel rooms, white
PAW-RE2D4-BK	Display control for hotel rooms, black
CZ-CENSC1	Econavi energy saving sensor
CZ-P56SVK2	External valve for model sizes 15 to 56
CZ-P160SVK2	External valve for model sizes 60 to 106
CZ-CGLSC1	Panasonic R32 refrigerant leak detector

Technical focus

- Compact lightweight units for easy installation
- Quiet operation
- Smooth and durable design
- Piping outlet in six directions
- Air distribution is automatically altered depending on the operational mode

Air distribution is automatically altered depending on the operational mode of the unit

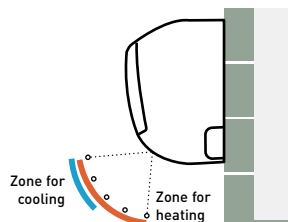

Quiet operation

These units are among the quietest in the industry, making them ideal for hotels and hospitals.

Lighter and smaller units

Compact and lightweight units make for easy installation. When the unit is turned OFF, the flap closes completely to prevent entry of dust into the unit and to keep the equipment clean.

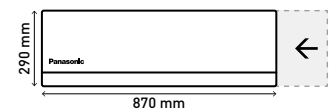

Piping outlet in six directions

Piping outlet is possible in six directions of; right, right rear, right bottom, left, left rear and left bottom, making the installation work more flexible.



External valve (optional)

CZ-P56SVK2 (model sizes 15 to 56).
CZ-P160SVK2 (model sizes 60¹⁾ to 106).

1) When the piping diameter is liquid 1/4(6,35) and gas 1/2(12,70), use CZ-P56SVK2



ECONAVI and INTERNET CONTROL: Optional.

Rating conditions: Cooling indoor 27 °C DB / 19 °C WB. Cooling outdoor 35 °C DB / 24 °C WB. Heating indoor 20 °C DB. Heating outdoor 7 °C DB / 6 °C WB. (DB: Dry Bulb; WB: Wet Bulb). Specifications subject to change without notice. For detailed information about ErP / Energy Labelling, please visit our websites www.aircon.panasonic.eu or www.ptc.panasonic.eu.

G1 type floor console · R410A

The stylish and compact unit profile, also used for residential market range, is easy to integrate into any design of building.

Compact and versatile, this system is capable of being installed in an area with limited space. It is a perfect solution for retrofit, replacing existing radiator panels.



+ COMPATIBLE WITH ALL PANASONIC CONNECTIVITY SOLUTIONS. FOR DETAILED INFORMATION GO TO THE CONTROL SYSTEMS SECTION

+ nanoEX™
nanoEX™ X as a standard.

Indoor unit		S-22MG1E5N	S-28MG1E5N	S-36MG1E5N	S-45MG1E5N	S-56MG1E5N
Cooling capacity	kW	2,2	2,8	3,6	4,5	5,6
Input power	W	20,00	20,00	22,00	28,00	31,00
Current	A	0,20	0,20	0,23	0,25	0,28
Heating capacity	kW	2,5	3,2	4,2	5,0	6,3
Input power	W	21,00	21,00	23,00	29,00	32,00
Current	A	0,20	0,20	0,24	0,26	0,28
Fan type		Cross flow	Cross flow	Cross flow	Cross flow	Cross flow
nano X Generator		Mark 1	Mark 1	Mark 1	Mark 1	Mark 1
Air flow	Cool (Hi/Med/Lo)	m ³ /min	9,2/7,5/6,0	9,2/7,5/6,0	9,7/8,2/6,0	10,5/9,0/6,5
	Heat (Hi/Med/Lo)	m ³ /min	9,7/8,0/6,5	9,7/8,0/6,5	10,2/8,7/6,5	11,0/9,5/7,0
Sound pressure	Hi/Med/Lo	dB(A)	38/34/29	38/34/29	39/35/29	42/37/30
Dimension	H x W x D	mm	600 x 750 x 207	600 x 750 x 207	600 x 750 x 207	600 x 750 x 207
Net weight		kg	14	14	14	14
Piping diameter	Liquid	Inch (mm)	1/4(6,35)	1/4(6,35)	1/4(6,35)	1/4(6,35)
	Gas	Inch (mm)	1/2(12,70)	1/2(12,70)	1/2(12,70)	1/2(12,70)

* Infrared receiver is integrated with the unit as standard.

Accessories	
CZ-RTC6W	CONEX wired remote controller (non-wireless), white
CZ-RTC6WBL	CONEX wired remote controller with Bluetooth®, white
CZ-RTC6	CONEX wired remote controller (non-wireless), black
CZ-RTC6BL	CONEX wired remote controller with Bluetooth®, black
CZ-RTC5B	Wired remote controller with Econavi function
CZ-RWS3*	Infrared remote controller

Accessories	
PAW-RE2C4-MOD-WH	Room controller for hotel rooms, white
PAW-RE2C4-MOD-BK	Room controller for hotel rooms, black
PAW-RE2D4-WH	Display control for hotel rooms, white
PAW-RE2D4-BK	Display control for hotel rooms, black
CZ-CENSC1	Econavi energy saving sensor

1 nanoEX™ X: Bringing nature's balance indoors

Panasonic's nanoEX™ X technology brings nature's detergent – hydroxyl radicals – indoors to help improve protection 24/7 against several types of pollutants can be inhibited such as certain types of bacteria, viruses, mould, allergens, pollen or hazardous substances.

2 Stylish and simple

- Clean and modern European design with slim depth
- Modern matt white color panel
- Washable air filter

The stylish and compact unit profile, also used for residential market range, is easy to integrate into any design of building.



Dimension:
W x H x D = 750 x 600 x 207 mm

Weight:
14kg

3 Flexible easy installation

Four different mounting styles possible: exposed (floor or wall), semi-recessed and recessed.

Flexible installation with 4 different options.

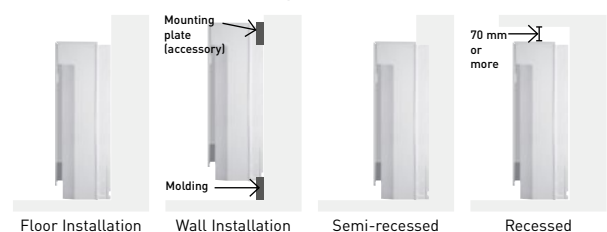

4 Functions for comfort

- Double Air Flow direction to maximize comfort
- Self-cleaning function
- Compatible with Commercial Wi-Fi Adaptor for cloud control

Self-cleaning function.

- Self cleaning function can be pre-scheduled with remote controller, up to a maximum of 90 minutes following cooling / dry operation
- Air flow will not blow directly at occupants during self-cleaning



ECONAVI and INTERNET CONTROL: Optional.

P1 type floor-standing · R410A

The compact floor-standing P1 units are the ideal solution for providing perimeter air conditioning.



+ COMPATIBLE WITH ALL PANASONIC CONNECTIVITY SOLUTIONS. FOR DETAILED INFORMATION GO TO THE CONTROL SYSTEMS SECTION

Indoor unit			S-22MP1E5	S-28MP1E5	S-36MP1E5	S-45MP1E5	S-56MP1E5	S-71MP1E5
Cooling capacity		kW	2,2	2,8	3,6	4,5	5,6	7,1
Input power		W	56,00	56,00	85,00	126,00	126,00	160,00
Current		A	0,25	0,25	0,38	0,56	0,56	0,72
Heating capacity		kW	2,5	3,2	4,2	5,0	6,3	8,0
Input power		W	40,00	40,00	70,00	91,00	91,00	120,00
Current		A	0,18	0,18	0,31	0,41	0,41	0,54
Fan type			Sirocco fan	Sirocco fan	Sirocco fan	Sirocco fan	Sirocco fan	Sirocco fan
Air flow	Hi/Med/Lo	m ³ /min	7,0/6,0/5,0	7,0/6,0/5,0	9,0/7,0/6,0	12,0/9,0/8,0	15,0/13,0/11,0	17,0/14,0/12,0
External static pressure		Pa	15	15	15	15	15	15
Sound pressure	Hi/Med/Lo	dB(A)	33/30/28	33/30/28	39/35/29	38/35/31	39/36/31	41/38/35
Dimension	HxWxD	mm	615x1065x230	615x1065x230	615x1065x230	615x1380x230	615x1380x230	615x1380x230
Net weight		kg	29	29	29	39	39	39
Piping diameter	Liquid	Inch (mm)	1/4(6,35)	1/4(6,35)	1/4(6,35)	1/4(6,35)	1/4(6,35)	3/8(9,52)
	Gas	Inch (mm)	1/2(12,70)	1/2(12,70)	1/2(12,70)	1/2(12,70)	1/2(12,70)	5/8(15,88)

Accessories

CZ-RTC6W	CONEX wired remote controller (non-wireless), white
CZ-RTC6WBL	CONEX wired remote controller with Bluetooth®, white
CZ-RTC6	CONEX wired remote controller (non-wireless), black
CZ-RTC6BL	CONEX wired remote controller with Bluetooth®, black
CZ-RTC5B	Wired remote controller with Econavi function

Accessories

CZ-RWS3 + CZ-RWRC3	Infrared remote controller and receiver
PAW-RE2C4-MOD-WH	Room controller for hotel rooms, white
PAW-RE2C4-MOD-BK	Room controller for hotel rooms, black
PAW-RE2D4-WH	Display control for hotel rooms, white
PAW-RE2D4-BK	Display control for hotel rooms, black

Technical focus

- Pipes can be connected to either side of the unit from the bottom or rear
- Easy to install
- Front panel opens fully for easy maintenance
- Removable air discharge grille gives flexible airflow
- Room for condensate pump

Effective perimeter handling

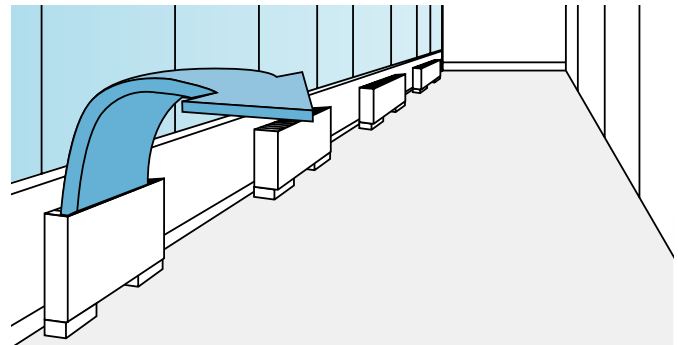

INTERNET CONTROL: Optional.

Rating conditions: Cooling indoor 27 °C DB / 19 °C WB. Cooling outdoor 35 °C DB / 24 °C WB. Heating indoor 20 °C DB. Heating outdoor 7 °C DB / 6 °C WB. (DB: Dry Bulb; WB: Wet Bulb). Specifications subject to change without notice. For detailed information about ErP / Energy Labelling, please visit our websites www.aircon.panasonic.eu or www.ptc.panasonic.eu.

R1 type concealed floor-standing · R410A

At just 229 mm deep, the R1 unit can be easily concealed in perimeter areas to provide powerful and effective air conditioning.

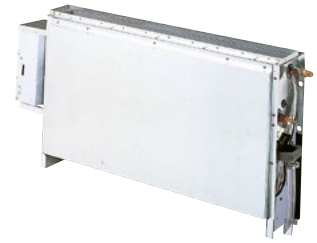

+ COMPATIBLE WITH ALL PANASONIC CONNECTIVITY SOLUTIONS. FOR DETAILED INFORMATION GO TO THE CONTROL SYSTEMS SECTION

Indoor unit		S-22MR1E5	S-28MR1E5	S-36MR1E5	S-45MR1E5	S-56MR1E5	S-71MR1E5	
Cooling capacity	kW	2,2	2,8	3,6	4,5	5,6	7,1	
Input power	W	56,00	56,00	85,00	126,00	126,00	160,00	
Current	A	0,25	0,25	0,38	0,56	0,56	0,72	
Heating capacity	kW	2,5	3,2	4,2	5,0	6,3	8,0	
Input power	W	40,00	40,00	70,00	91,00	91,00	120,00	
Current	A	0,18	0,18	0,31	0,41	0,41	0,54	
Fan type		Sirocco fan	Sirocco fan	Sirocco fan	Sirocco fan	Sirocco fan	Sirocco fan	
Air flow	Hi/Med/Lo	m ³ /min	7,0/6,0/5,0	7,0/6,0/5,0	9,0/7,0/6,0	12,0/9,0/8,0	15,0/13,0/11,0	17,0/14,0/12,0
External static pressure		Pa	15	15	15	15	15	
Sound pressure	Hi/Med/Lo	dB(A)	33/30/28	33/30/28	39/35/29	38/35/31	39/36/31	41/38/35
Dimension	HxWxD	mm	616x904x229	616x904x229	616x904x229	616x1219x229	616x1219x229	616x1219x229
Net weight		kg	21	21	21	28	28	28
Piping diameter	Liquid	Inch (mm)	1/4(6,35)	1/4(6,35)	1/4(6,35)	1/4(6,35)	1/4(6,35)	3/8(9,52)
	Gas	Inch (mm)	1/2(12,70)	1/2(12,70)	1/2(12,70)	1/2(12,70)	1/2(12,70)	5/8(15,88)

Accessories

CZ-RTC6W	CONEX wired remote controller (non-wireless), white
CZ-RTC6WBL	CONEX wired remote controller with Bluetooth®, white
CZ-RTC6	CONEX wired remote controller (non-wireless), black
CZ-RTC6BL	CONEX wired remote controller with Bluetooth®, black
CZ-RTC5B	Wired remote controller with Econavi function

Accessories

CZ-RWS3 + CZ-RWRC3	Infrared remote controller and receiver
PAW-RE2C4-MOD-WH	Room controller for hotel rooms, white
PAW-RE2C4-MOD-BK	Room controller for hotel rooms, black
PAW-RE2D4-WH	Display control for hotel rooms, white
PAW-RE2D4-BK	Display control for hotel rooms, black

Technical focus

- Chassis unit for discreet installation
- Complete with removable filters
- Pipes can be connected to either side of the unit from the bottom or rear
- Easy to install

Perimeter air conditioning with high interior quality

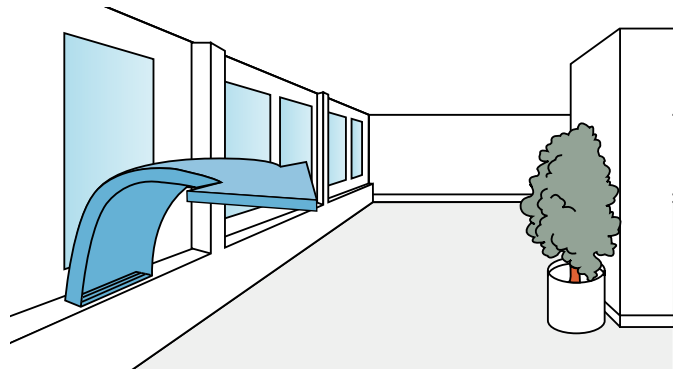

INTERNET CONTROL: Optional.

Hydrokit for ECOi, water at 45 °C · R410A

Connect the Hydrokit to your VRF system, together with other indoor units.

Total system performs high energy efficiency through heat recovering operation, and it gives an advantage for sustainability related assessment methods, such as BREEAM in UK.



+ COMPATIBLE WITH ALL PANASONIC CONNECTIVITY SOLUTIONS. FOR DETAILED INFORMATION GO TO THE CONTROL SYSTEMS SECTION

Indoor unit			S-80MW1E5	S-125MW1E5	
Power supply	Voltage	V	230	230	
	Phase		Single phase	Single phase	
	Frequency	Hz	50	50	
Cooling capacity		kW	8,0	12,5	
Heating capacity		kW	9,0	14,0	
Maximum temperature		°C	-45 / -65 ¹⁾	-45 / -65 ¹⁾	
Dimension	H x W x D	mm	892 x 502 x 353	892 x 502 x 353	
Water pipe connector		Inch	R 1 ¼	R 1 ¼	
Water pump (built-in)			DC motor (A class)	DC motor (A class)	
Water flow rate	Cool	L/min	22,90	35,80	
	Heat	L/min	25,80	40,10	
Piping diameter	Liquid	Inch (mm)	3/8 (9,52)	3/8 (9,52)	
	Gas	Inch (mm)	5/8 (15,88)	5/8 (15,88)	
	Drain	mm	15 ~ 17 (inner size)	15 ~ 17 (inner size)	
Operation range	Cool	Ambient	°C	+10 ~ +43	+10 ~ +43
		Water	°C	+5 ~ +20	+5 ~ +20
	Heat	Ambient	°C	-20 ~ +43	-20 ~ +43
		Water	°C	+25 ~ +45	+25 ~ +45
Connectable system	3-Pipe (heat recovery type) VRF System (system capable up to 48 HP)				
Maximum Indoor ratio (connectable hydrokit module capacity ratio)			Total indoor unit + Hydrokit capacity: up to 130% (** ~ **% vs total outdoor unit capacity)		

1) Maximum 45 °C by refrigerant circuit (heat pump cycle), over 45 °C is provided by electric heater operation.

Accessories

CZ-RTC5B Wired remote controller with Econavi function

Basic principle and advantage.

Hydrokit module provides hot water by using waste heat that is recovered from standard air-conditioning indoor unit in cooling mode.

Technical focus

- Only with 3-Pipe ECOi EX MF3 Series outdoor units
- Remote controller CZ-RTC5B common use with DX coil indoor units ECOi and PACi

Hydrokit control function / CZ-RTC5B

- CZ-RTC5B can be used for hydrokit and also normal indoor unit. CZ-RTC5B checks the type of connected unit and switches between hydrokit and air conditioner display automatically

- Hydrokit mode (tank or air conditioning mode) is set during initial startup

Overview: hydromodule in VRF system

- Multiple hydromodule connection in same circuit is available
- The mode of each module can be individually set from either hot water or space heating / cooling (once set the units cannot operate in another mode, resetting will be required)
- 3-Pipe control solenoid valve kit is necessary for each indoor unit and hydromodule

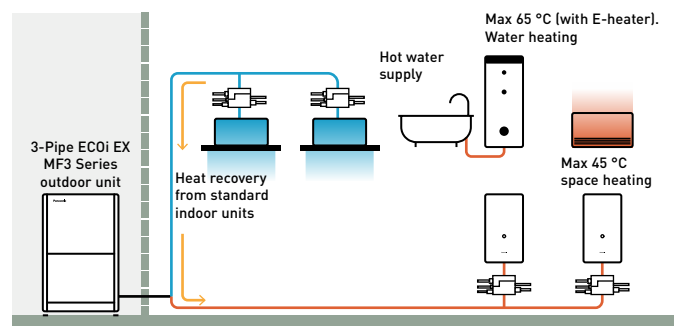

PRO-HT Tank Series for ECOi

PRO-HT Tank DHW. Big volume and high temperature tank for commercial application.

Maximum 65 °C
water outlet temperature



1 High performance and high saving

- A7 COP maximum 5,29 and 6,70 for ECOi 3-Pipe in case of heat recovery
- Efficient hot water production by heat recovery
- High temperature hot water without booster
- Save installation time and cost by skipping additional accessories

2 Hot water production with simultaneous heating and cooling

- Maximum water outlet temperature up to 65 °C without an electric heater
- Big volume tank from 750L to 1000L capacity
- Heat exchanger design inhibits limescale

3 Trusted quality

- Double tube heat exchanger following drinking-water regulation
- Tank and heat exchanger made with stainless steel
- Internal and external pickling

Solution example DHW tank 1000L + ECOi 3-Pipe mixed system

- Ideal offer for hotel projects
- DHW production under spontaneous heating and cooling
- Hot water up to 65 °C is efficiently produced by heat recovery
- A7 COP 6,70 considering heat recovery

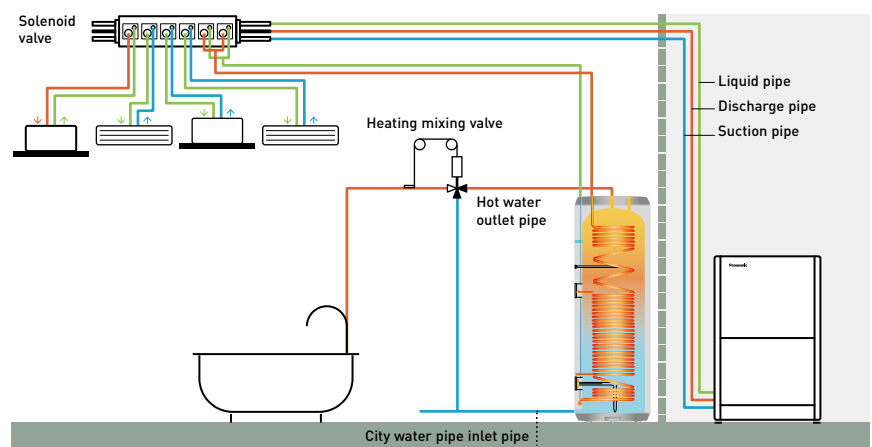

One by one system compatible list with ECOi

Model	Tank type	Product compatibility	Hot water outlet temperature
PAW-VP750LDHW-1	DHW	U-16MF3 (3-Pipe)	65 °C
PAW-VP1000LDHW-1	DHW	U-16MF3 (3-Pipe)	65 °C

PRO-HT Tank DHW

Enjoy an efficient DHW.

Panasonic commercial PRO-HT Tank solutions meet all needs of your hot water applications providing 65 °C maximum water temperature.

High temperature hot water is efficiently produced without any boosters.

Can be combined with 3-Pipe ECOi EX MF3 Series to adapt various projects from high-end residential to offices and hotels.

PRO-HT TANK



PRO-HT Tank			PAW-VP750LDHW-1	PAW-VP1000LDHW-1	
COP DHW (A +7 °C, W 10-55 °C) EN 16147 ¹⁾			5,29	4,81	
COP DHW (A +15 °C, W 10-55 °C) EN 16147 ²⁾			7,01	5,32	
Water volume (net)	L		726	933	
Reference tapping cycle			2XL	2XL	
Standby heat loss according to EN16147	W/h		77	80	
Maximum water temperature	Heat pump	°C	65	65	
	Electrical heater	°C	85	85	
Dimension	H x Ø	mm	1855x990	2210x990	
Net weight / with water	kg		179 / 905	191 / 1124	
Stainless steel 316 L tank			Yes	Yes	
Connections to the water supply network			RP 1¼	RP 1¼	
Average insulation thickness	mm		100	100	
Number of electrical heaters x power	W		1 x 6000	1 x 6000	
Electric protection	A		16	16	
Moisture protection (PAW-VP-RTC5B-VRF)			IP24	IP24	
Heat exchanger connection	Inlet	Inch (mm)	1/2 (12,70)	1/2 (12,70)	
	Outlet	Inch (mm)	3/4 (19,05)	3/4 (19,05)	
Tubing connection between SVK and tank	Liquid	Inch (mm)	3/8 (9,52)	3/8 (9,52)	
	Gas	Inch (mm)	3/4 (19,05)	3/4 (19,05)	
Outdoor unit			U-16MF3E8	U-16MF3E8	
Energy consumption by chosen cycle (A +7 °C, W 10-55 °C)			kWh	4,14	5,10
Energy consumption by chosen cycle (A +15 °C, W 10-55 °C)			kWh	3,50	4,61
Power supply	Voltage	V	400	400	
	Phase		Three phase	Three phase	
	Frequency	Hz	50	50	
Maximum power consumption	Without heater	W	20400	20400	
	With heater	W	26400	26400	
Sound pressure at 1m from outdoor unit		dB(A)	52	52	
Refrigerant (R410A) / CO ₂ Eq.		kg / T	8,3 / 17,300	8,3 / 17,300	
Pipe length range from outdoor unit		m	50	50	
Elevation difference (in / out)		m	30 (OU above) 30 (OU below)	30 (OU above) 30 (OU below)	
Pipe length for nominal capacity		m	7,5	7,5	
Pre-charged pipe length		m	> 7,5	> 7,5	
Additional gas amount		g/m	Refer to manual	Refer to manual	
Operating range - outdoor ambient	Heat Min ~ Max	°C	-20 ~ +35	-20 ~ +35	

1) Heating of sanitary water up to 55 °C with inlet air temperature at 7 °C, humidity at 89% and inlet water temperature at 10 °C. According to EN16147. 2) Heating of sanitary water up to 55 °C with inlet air temperature at 15 °C, humidity at 74% and inlet water temperature at 10 °C. According to EN16147.

This product is designed to comply with the European Water Quality Directive 98/83/EC amended by 2015/1787/EU. The lifespan of the product is not guaranteed in the case of the use of groundwater, such as spring water or well water, the use of tap water when salt or other impurities are contained, nor in areas of acidic water quality. Maintenance and warranty costs related to these cases are the customer's responsibility.

* When connected as pressurised, safety valve is mandatory.

Accessories

PAW-VP-RTC5B-VRF	Tank Controller for ECOi system
PAW-VP-VALV-280	Expansion valve kit 28 kW

Technical focus

- Water volume 750 L and 1000 L
- Maximum hot water outlet temperature 65 °C without boosters
- Heating coil 52 m (750 L) and 63 m (1000 L)
- Tank material 3 mm
- ABS external case



Fan coils highlighted features

+ MORE FAN COIL OPTIONS IN CHILLERS SECTION

Available in a wide range of designs, the fan coils are perfectly adapted to fit within almost any location.



1 Innovation for an optimum comfort

Range of fan coils for heating and cooling with capacities from 0,2 to 9,6 kW in cooling and from 0,2 to 13,6 kW in heating. Bring full year comfort with hydronic systems.

3 Quality and efficient coil

Constructed from staggered copper tubes, mechanically expanded into aluminium fins, providing maximum heat transfer efficiency, durability and hygiene.

2 Energy efficient and low noise fan

Dynamically balanced and specially designed fans, reinforced acoustic insulation and optimised fan speed staging for lower noise levels. Improved efficiency with optional EC fan motor.

4 Flexible installation

Various types of unit to fit your needs with flexible installation options. A choice of service side for hydraulic connections, piping configuration and horizontal or vertical installation for ducted units.

Offering a great range of capacities and performance, available in a wide range of designs, the fan coils are perfectly adapted to fit within almost any location. Whether the requirements are for cooling only, or for both heating and cooling, there is a fan coil to suit. With a variety of piping and fan configuration, the range is capable of meeting the most stringent of requirements. Line up available in AC and EC fans, it is possible to achieve both powerful performance, but with sustainability in mind.

Controllers with sophisticated designs, provide a user friendly interface while enabling an easy and low cost integration to building management systems.

Optional wired remote controller for AC fan, 2-pipe and 4-pipe application.



PAW-FC-RC1

Optional wired remote controller for AC fan 2-pipe application.



PAW-FC-903AC



PAW-FC-907AC

Optional wired remote controller for EC fan, 2-pipe and 4-pipe application.



PAW-FC-903EC



PAW-FC-907EC

Smart fan coils



Built-in advanced thermostat.

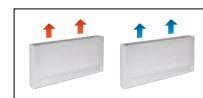

			PAW-AAIR-200-2	PAW-AAIR-700-2	PAW-AAIR-900-2	NEW PAW-AAIR-1100-2
Total cooling capacity	Lo/Med/Hi	kW	0,3/0,5/0,6	0,6/0,9/1,5	0,8/1,6/2,1	0,9/1,8/2,5
Sensible capacity	Lo/Med/Hi	kW	0,2/0,4/0,6	0,5/0,9/1,3	0,7/1,3/1,9	0,9/1,6/2,3
Water flow	Lo/Med/Hi	kg/h	51,1/89,4/106,3	96,0/155,2/251,1	140,8/267,2/365,7	158,1/300,3/423,6
Water pressure drop	Lo/Med/Hi	kPa	3,3/5,7/6,1	1,1/2,1/4,2	1,5/5,8/10,3	1,3/5,0/10,6
Inlet water temperature		°C	10	10	10	10
Outlet water temperature		°C	15	15	15	15
Inlet air temperature		°C	27	27	27	27
Outlet air temperature	Lo/Med/Hi	°C	12,8/13,2/14,9	14,6/14,8/14,0	15,8/14,6/14,4	18,1/15,2/14,7
Relative humidity of inlet air		%	47	47	47	47
Total heating capacity	Lo/Med/Hi	kW	0,2/0,4/0,5	0,4/0,8/1,2	0,6/1,2/1,6	0,8/1,4/2,1
Water flow	Lo/Med/Hi	kg/h	38,4/70,5/92,8	72,7/139,2/201,6	114,0/204,2/284,5	138,3/243,2/356,7
Water pressure drop	Lo/Med/Hi	kPa	1,0/2,3/3,0	0,5/1,5/3,1	1,0/3,3/6,6	1,1/3,1/7,3
Inlet water temperature		°C	35	35	35	35
Outlet water temperature		°C	30	30	30	30
Inlet air temperature		°C	19	19	19	19
Outlet air temperature	Lo/Med/Hi	°C	33,5/33,3/30,9	30,1/31,4/31,8	30,1/31,1/31,2	26,6/29,5/30,5
Air flow	Lo/Med/Hi	m ³ /min	0,9/1,9/2,7	2,6/4,2/5,3	4,1/6,1/7,7	6,2/7,6/9,6
Maximum input power	Lo/Med/Hi	W	7,0/9,0/13,0	14,0/18,0/22,0	16,0/20,0/24,0	18,0/22,0/26,5
Sound pressure	Lo/Med/Hi	dB(A)	24/33/39	25/34/40	25/34/42	26/35/43
Dimension (HxWxD)		mm	735x579x129	935x579x129	1135x579x129	1335x579x129
Net weight		kg	17	20	23	26
3 Ways valve included			Yes	Yes	Yes	Yes
Touch screen thermostat			Yes	Yes	Yes	Yes

* Smart fan coils is produced by Innova.

Accessories

PAW-AAIR-LEGS-1 Kits of 2 legs to protect the water pipings

Accessories

PAW-AAIR-RHCABLE Motor connection cable for units with hydraulic connections on the right

Stylish floor-standing fan coils with advanced controller

The slimline of Smart fan coils delivers high efficiency climate control.

With a depth of just under 130 mm they are at the cutting edge of the market. Blending easily into the home, Smart fan coil's elegant design and product refinements are clear to see in every detail.

Exceptional ventilation efficiency means the motor uses considerably less energy (low wattage). The fan speed is continuously modulated by the temperature controller with proportional integral logic, with undoubted advantages for regulating the temperature and humidity in summer mode.

Technical focus

- 4 operation modes (auto, silent, night-time and maximum ventilation speed)
- Exclusive design
- Extremely compact (only 129 mm deep)
- Cooling and dehumidification functions possible (drain is needed)
- 3-way valve included (no overflow valve needed on the installation if more than 3 units installed)
- Touch screen thermostat

With standard cast radiators.

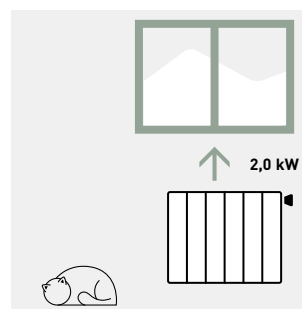

Water at 65 °C needed.

With Smart fan coil.

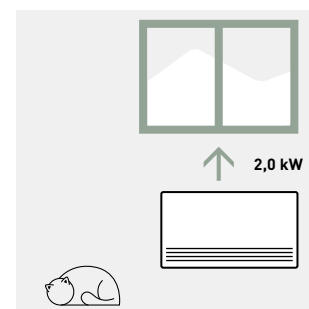

Water at 35 °C needed.

All temperature curves and capacity are available on www.panasonicproclub.com

PRO Club



Fan coils - ducted (AC)



Optional controller.
Advanced wired remote
controller.
PAW-FC-RC1



Optional controller.
Wired remote controller
with touch control.
PAW-FC-907AC



Optional controller.
Wired remote controller.
PAW-FC-903AC



Left connection (PAW-)			FC2A-D010L	FC2A-D020L	FC2A-D030L	FC2A-D040L	FC2A-D050L	FC2A-D060L	FC2A-D070L	FC2A-D080L
Right connection (PAW-)			FC2A-D010R	FC2A-D020R	FC2A-D030R	FC2A-D040R	FC2A-D050R	FC2A-D060R	FC2A-D070R	FC2A-D080R
Total cooling capacity ¹⁾	Lo/Med/Hi	kW	0,7/1,0/1,5	0,7/1,2/1,7	1,0/2,0/2,5	1,2/2,4/3,2	1,7/3,2/4,6	2,7/4,6/5,8	3,4/6,1/7,3	4,6/6,1/8,1
Sensible capacity ¹⁾	Lo/Med/Hi	kW	0,5/0,8/1,1	0,6/0,9/1,3	0,8/1,5/1,9	0,9/1,8/2,3	1,2/2,2/3,3	1,9/3,3/4,5	2,4/4,3/5,1	3,4/4,6/6,3
Water flow	Lo/Med/Hi	l/h	124/172/250	127/213/289	172/341/430	206/413/547	296/544/798	466/784/1003	587/1058/1252	798/1048/1400
Water pressure drop	Lo/Med/Hi	kPa	10,7/19,5/39,2	1,9/3,9/6,3	6,3/19,3/28,8	5,4/17,1/28,0	7,5/22,8/46,9	13,9/37,4/60,2	4,8/15,4/21,5	11,9/19,3/32,5
Heating capacity ²⁾	Lo/Med/Hi	kW	0,9/1,4/2,0	0,9/1,5/2,2	1,3/2,4/3,1	1,4/2,9/4,0	2,1/4,1/5,7	3,1/5,3/7,1	4,3/7,9/9,3	5,9/8,1/11,6
Sound levels										
Global sound power	Lo/Med/Hi	dB(A)	33/40/49	31/43/50	30/45/52	30/44/51	34/46/56	38/51/58	43/56/61	50/55/64
Global sound pressure ³⁾	Lo/Med/Hi	dB(A)	24/31/40	22/34/41	21/36/43	21/35/42	25/37/47	29/42/49	34/47/52	41/46/55
Fan										
Number			1	1	1	2	2	2	2	3
Air flow	Lo/Med/Hi	m ³ /h	111/190/283	105/179/265	138/274/390	173/357/499	253/486/716	350/640/933	480/893/1064	660/936/1397
External pressure	Max	Pa	55	55	65	85	85	115	125	70
Filter			G2	G2	G2	G2	G2	G2	G2	G2
Electrical data										
Power supply	Voltage	V	230	230	230	230	230	230	230	230
	Phase		Single phase	Single phase	Single phase	Single phase	Single phase	Single phase	Single phase	Single phase
	Frequency	Hz	50/60	50/60	50/60	50/60	50/60	50/60	50/60	50/60
Consumption	Lo/Med/Hi	W	13/24/36	10/18/29	16/37/45	15/37/56	28/55/72	37/75/105	53/100/147	90/112/188
Water connections										
Type			Female gas threaded	Female gas threaded	Female gas threaded	Female gas threaded	Female gas threaded	Female gas threaded	Female gas threaded	Female gas threaded
Water connections	Inch		1/2	1/2	1/2	1/2	1/2	1/2	3/4	3/4
Dimension and weight										
Dimension	HxWxD	mm	220x570x430	220x570x430	220x730x430	220x938x430	220x1122x430	220x1307x430	220x1121x530	220x1316x530
Weight		kg	13	13	15	20	22	26	27	38

1) According to Eurovent standard. Air: 27 °C DB / 19 °C WB. Water in / out: 7 °C / 12 °C. 2) Air: 20 °C. Water in / out: 50 °C / 45 °C. 3) The sound pressure levels are based on (NR) characteristics of a room having volume of 100 m³ with reverberation of 0,5 seconds.

Values indicated are for 0 Pa external static pressure, for additional pressure characteristics, please refer the selection software. * Fan coil units are produced by Systemair.

Accessories

PAW-FC-RC1	Advanced wired remote controller
PAW-FC-907AC	Wired remote controller with touch control
PAW-FC-903AC	Wired remote controller
PAW-FC-2WY-11/55-1	2 way valve + drain pan for models 010-060

Accessories

PAW-FC-2WY-65/90-1	2 way valve + drain pan for models 070-080
PAW-FC-3WY-11/55-1	3 way valve + drain pan for models 010-060
PAW-FC-3WY-65/90-1	3 way valve + drain pan for models 070-080

Technical focus

- Cooling capacity: 0,7 to 8,1 kW
- Heating capacity: 0,7 to 10,3 kW
- 5-speed AC fan motor(s)

Main features and accessories

- Left or right hand arrangements
- Ease of installation
- Very low acoustic levels
- 2 way or 3 way ON / OFF valves
- Auxiliary drain pan
- Air intake with removable grid
- G2 filter

Operating limits

Entering water temperature	From 5 to 90 °C
Indoor air temperature	From 5 to 32 °C



Fan coils - wall-mounted (AC)



Optional controller.
Advanced wired remote
controller.
PAW-FC-RC1



Optional controller.
Wired remote controller
with touch control.
PAW-FC-907AC



Optional controller.
Wired remote controller.
PAW-FC-903AC



Infrared remote supplied
with IR versions.
IR Controller



2-pipe			PAW-FC2A-K007	PAW-FC2A-K009	PAW-FC2A-K018	PAW-FC2A-K022
			PAW-FC2A-K007IR	PAW-FC2A-K009IR	PAW-FC2A-K018IR	PAW-FC2A-K022IR
Total cooling capacity ¹⁾	Lo/Med/Hi	kW	1,0/1,3/1,7	1,6/1,7/2,4	2,8/3,0/3,5	2,9/3,1/3,9
Sensible capacity ¹⁾	Lo/Med/Hi	kW	0,7/1,0/1,2	1,2/1,3/1,9	2,1/2,3/2,7	2,3/2,5/3,1
Water flow	Lo/Med/Hi	l/h	172/231/287	270/291/418	483/508/609	502/535/669
Water pressure drop	Lo/Med/Hi	kPa	18,6/24,9/30,9	18,5/27,0/40,0	34,6/41,3/55,6	37,2/33,7/45,2
Heating capacity ²⁾	Lo/Med/Hi	kW	1,4/1,7/2,0	1,7/2,0/2,7	2,9/3,2/4,0	3,1/3,7/4,4
Sound levels						
Sound power	Lo/Med/Hi	dB(A)	45/49/51	47/52/57	49/53/59	56/59/63
Sound pressure ³⁾	Lo/Med/Hi	dB(A)	32/36/38	34/39/44	40/43/46	43/46/50
Fan						
Number			1	1	1	1
Air flow	Lo/Med/Hi	m ³ /h	282/321/360	367/413/551	532/592/680	617/709/850
Filter			G1	G1	G1	G1
Electrical data						
Power supply	Voltage	V	230	230	230	230
	Phase		Single phase	Single phase	Single phase	Single phase
	Frequency	Hz	50	50	50	50
Fuse rating		A	3	3	3	3
Consumption	Lo/Med/Hi	W	39/42/62	30/47/59	44/50/55	50/55/70
Water connections						
Type			Female gas threaded	Female gas threaded	Female gas threaded	Female gas threaded
Water connections		Inch	1/2	1/2	1/2	1/2
Dimension and weight						
Dimension	HxWxD	mm	275 x 180 x 845	275 x 180 x 845	298 x 200 x 940	298 x 200 x 940
Weight		kg	11	11	13	13

1) According to Eurovent standard. Air: 27 °C DB / 19 °C WB. Water in / out: 7 °C / 12 °C. 2) According to Eurovent standard. Air: 20 °C. Water in / out: 45 °C / 40 °C. 3) Sound pressure considering a local of 100 m³ a reverberation time of 0,5 seconds and a distance of 1 m.

Accessories

PAW-FC-RC1	Advanced wired remote controller
PAW-FC-907AC	Wired remote controller with touch control
PAW-FC-903AC	Wired remote controller

Accessories

PAW-FC2-2WY-K007	2 way valve
PAW-FC2-3WY-K007	3 way valve

Technical focus

- 4 sizes
- Cooling capacity: 1,0 to 3,9 kW
- Heating capacity: 1,4 to 4,1 kW
- Version: 2-pipes, AC fan

Main features and accessories

- 2 way or 3 way valve ON / OFF
- 3-speed AC fan motor
- Silent unit for optimum customer comfort
- Aesthetic design suitable for residential and hotel applications
- Compatible with IR controller (supplied with IR versions)
- Coil with hydrophilic fins to improve the condensate flow

* The electric movement of the flaps is available for the IR version.

Operating limits

Entering water temperature	From 5 to 60 °C
Indoor air temperature	From 6 to 40 °C



Accessories and control

Distribution joint kits





2-Pipe ME2 for outdoor units (up to 68,0 kW). ----- CZ-P680PH2BM	2-Pipe ME2 for outdoor units (from 68,0 kW to 168,0 kW). ----- CZ-P1350PH2BM	2-Pipe ME2 and Mini ECOi for indoor units (up to 22,4 kW*). ----- CZ-P224BK2BM
2-Pipe ME2 for indoor units (from 22,4 kW to 68,0 kW*). ----- CZ-P680BK2BM	2-Pipe ME2 for indoor units (from 68,0 kW to 168,0 kW*). ----- CZ-P1350BK2BM	3-Pipe MF3 for outdoor units (up to 68,0 kW). ----- CZ-P680PJ2BM
3-Pipe MF3 for outdoor units (from 68,0 kW to 135,0 kW). ----- CZ-P1350PJ2BM	3-Pipe MF3 for indoor units (up to 22,4 kW). ----- CZ-P224BH2BM	3-Pipe MF3 for indoor units (from 22,4 kW to 68,0 kW). ----- CZ-P680BH2BM
3-Pipe MF3 for indoor units (up to 68,0 kW). ----- CZ-P1350BH2BM	2-Pipe ME2 header pipe. ----- CZ-P4HP4C2BM	3-Pipe MF3 header pipe. ----- CZ-P4HP3C2BM

* In case the total capacity of indoor units connected after distribution exceeds the total capacity of the outdoor units, select the distribution piping size for the total capacity of the outdoor units.

Heat recovery box

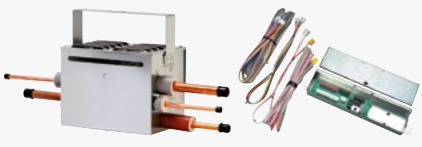

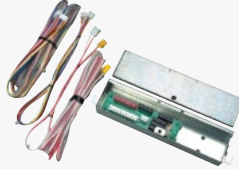
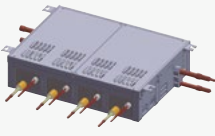
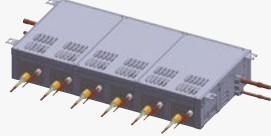
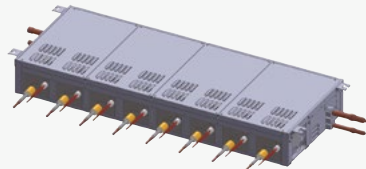
 3-Pipe control Solenoid valve kit (up to 5,6 kW). CZ-P56HR3 + CZ-CAPE2. ----- KIT-P56HR3	 Solenoid valve kit (up to 5,6 kW). ----- CZ-P56HR3	 3-Pipe control PCB. ----- CZ-CAPE2
3-Pipe control Solenoid valve kit (from 5,6 to 16,0 kW). CZ-P160HR3 + CZ-CAPE2. ----- KIT-P160HR3	Solenoid valve kit (from 5,6 kW to 16,0 kW). ----- CZ-P160HR3	3-Pipe control PCB for wall-mounted. ----- CZ-CAPEK2
 4 ports 3 pipe box (up to 5,6 kW per port). ----- CZ-P456HR3	 6 ports 3 pipe box (up to 5,6 kW per port). ----- CZ-P656HR3	 8 ports 3 pipe box (up to 5,6 kW per port). ----- CZ-P856HR3
4 ports 3 pipe box (up to 16,0 kW per port). ----- CZ-P4160HR3		

Panels

 Standard panel for 4 way 90x90 cassette. ----- CZ-KPU3W	 Econavi panel for 4 way 90x90 cassette. ----- CZ-KPU3AW	 Panel for 4 way 60x60 cassette - MY3. ----- CZ-KPY4
---	---	---



Panel for 2 way cassette (for S-22 to S-56 models).

CZ-02KPL2



Panel for 2 way cassette (for S-73 model).

CZ-03KPL2

Panel for 1 way cassette.

CZ-KPD2

Sensors



Panasonic R32 refrigerant leak detector for MU2, MY3, MM1 and MK2 models.

CZ-CGLSC1



Econavi energy saving sensor.

CZ-CENSC1



Remote temperature sensor.

CZ-CSRC3

Plenums

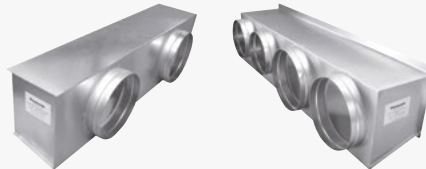

Air inlet plenum for MF3 and MF2 15, 22, 28, 36, 45 and 56.

CZ-DUMPA56MF2

Air inlet plenum for MF3 and MF2 60, 73 and 90.

CZ-DUMPA90MF2

Air inlet plenum for MF3 and MF2 106, 112, 140 and 160.

CZ-DUMPA160MF2

Air inlet plenum for MM1 22, 28, 36, 45 and 56.

CZ-DUMPA22MMR2

Air outlet plenum for MM1 22, 28 and 36.

CZ-DUMPA22MMS2

Air outlet plenum for MM1 45 and 56.

CZ-DUMPA45MMS3

Air outlet plenum for S-224ME1E5A.

CZ-TREMIESPW705

Air outlet plenum for S-280ME1E5.

CZ-TREMIESPW706

* Plenums installed with an R32 Mini ECOi system may only be used when no Panasonic R32 refrigerant leak detector is required. Please refer to technical data manual for refrigerant installation requirements.

Valves



E2 type high static pressure hide-away rap valve kit for 100% Fresh air function.

CZ-P160RVK2

Wall-mounted external valve for model sizes 15 to 56.

CZ-P56SVK2

Wall-mounted external valve for model sizes 60 to 106.

CZ-P160SVK2

VRF Smart Connectivity+



Remote controller Panasonic Net Con, RH, No PIR, R1/R2.

SER8150R0B1194

Remote controller Panasonic Net Con, RH, PIR, R1/R2.

SER8150R5B1194



Wireless ZigBee® Pro module / Green Com card.

VCM8000V5094P



Hotel room expansion module 14 indoor units.

HRCEP14R



Hotel room controller 28 indoor units.

HRCPBG28R

Hotel room controller w/Display 42 indoor units.

HRCPDG42R



Door / window wireless sensor.

SED-WDC-G-5045



Wall / ceiling (motion) wireless sensor.

SED-MTH-G-5045



CO₂ sensor.

SED-CO2-G-5045



Sensor with room temperature and humidity.

SED-TRH-G-5045



Water leakage sensor.

SED-WLS-G-5045



Cover frame. Silver.

FAS-00



Cover frame. White.

FAS-01



Cover frame. Glossy translucent white.

FAS-03



Cover frame. Light tan wood.

FAS-05



Cover frame. Dark brown wood.

FAS-06



Cover frame. Dark black wood.

FAS-07



Cover frame. Brushed steel finish.

FAS-10

Controller and touch controllers for hotels with dry contacts

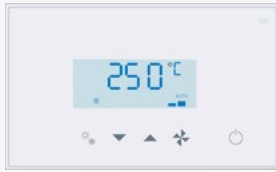

Modbus RS-485 touch room controller with I/O, white.

PAW-RE2C4-MOD-WH

Touch display control with 2 digital inputs, white.

PAW-RE2D4-WH



Modbus RS-485 touch room controller with I/O, black.

PAW-RE2C4-MOD-BK

Touch display control with 2 digital inputs, black.

PAW-RE2D4-BK

Hotel sensors for dry contacts



Wall motion sensor 24 V.

PAW-WMS-DC

Wall motion sensor 240 V AC.

PAW-WMS-AC



Ceiling motion sensor 24 V.

PAW-CMS-DC

Ceiling motion sensor 240 V AC.

PAW-CMS-AC



Power supply 24 V.

PAW-24DC



Door or window contact.

PAW-DWC

Centralised controls



System controller for 64 indoor units with weekly timer.

CZ-64ESMC3



Central ON / OFF controller, up to 16 groups, 64 indoor units.

CZ-ANC3



Intelligent controller (touch screen/web server) to control up to 256 indoors with included load distribution ratio (LDR).

CZ-256ESMC3

Centralised controls. BMS system. PC base



P-AIMS core software: Centralised software to control up to 1024 indoor units.

CZ-CSWKC2

P-AIMS communication adaptor.

CZ-CFUNC2

P-AIMS consumption calculation extension.

CZ-CSWAC2

P-AIMS layout display extension.

CZ-CSWGC2

P-AIMS BACnet extension.

CZ-CSWBC2

P-AIMS web application extension.

CZ-CSWWC2

Panasonic AC Smart Cloud



Panasonic AC Smart Cloud. Cloud internet control. Up to 128 groups. Controls 128 units.

CZ-CFUSCC1

BMS interface with S-Link



Modbus RTU and TCP interface for 16 indoor units.

PAW-AC2-MBS-16P

Modbus RTU and TCP interface for 64 indoor units.

PAW-AC2-MBS-64P

Modbus RTU and TCP interface for 128 indoor units.

PAW-AC2-MBS-128P

KNX interface for 16 indoor units.

PAW-AC2-KNX-16P

KNX interface for 64 indoor units.

PAW-AC2-KNX-64P



BACnet IP and MSTP interface for 16 indoor units.

PAW-AC2-BAC-16P

BACnet IP and MSTP interface for 64 indoor units.

PAW-AC2-BAC-64P

BACnet IP and MSTP interface for 128 indoor units.

PAW-AC2-BAC-128P

Accessories interfaces

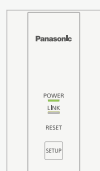

Commercial Wi-Fi Adaptor.

CZ-CAPWFC1



KNX interface (Intesis).

PAW-RC2-KNX-1i



Modbus RTU interface (Intesis).

PAW-RC2-MBS-1



Modbus RTU interface to control 4 indoor/groups (Intesis).

PAW-RC2-MBS-4



BACnet IP and MSTP (Intesis).

PAW-RC2-BAC-1



NEW KNX interface (Airzone).

PAW-AZRC-KNX-1



NEW Modbus RTU interface (Airzone).

PAW-AZRC-MBS-1



NEW BACnet IP and MSTP interface (Airzone).

PAW-AZRC-BAC-1



RAC interface adapter for integration into S-Link, plus external input and alarm/status output.

CZ-CAPRA1















LonWorks® Interface controls up to 16 groups and 64 indoor units.

CZ-CLNC2

Centralised controls. Connection with general equipment

 <p>Adaptor for ON / OFF control of external devices.</p> <p>-----</p> <p>CZ-CAPC3</p>	 <p>Demand control for Mini ECOi and PACi outdoor units.</p> <p>-----</p> <p>CZ-CAPDC3</p>	 <p>Mini series parallel device controlling indoor units, maximum 1 group and 8 indoor unit.</p> <p>-----</p> <p>CZ-CAPBC2</p>	 <p>Communication Adaptor. Up to 128 groups. Controls 128 units.</p> <p>-----</p> <p>CZ-CFUNC2</p>
--	--	---	--

Individual controls

 <p>NEW CONEX wired remote controller (non-wireless), white.</p> <p>-----</p> <p>CZ-RTC6W ¹⁾</p>	 <p>NEW CONEX wired remote controller with Bluetooth®, white.</p> <p>-----</p> <p>CZ-RTC6WBL ¹⁾</p>	 <p>CONEX wired remote controller (non-wireless), black.</p> <p>-----</p> <p>CZ-RTC6</p>
 <p>CONEX wired remote controller with Bluetooth®, black.</p> <p>-----</p> <p>CZ-RTC6BL</p>	 <p>Design wired remote controller with Econavi function.</p> <p>-----</p> <p>CZ-RTC5B</p>	 <p>Infrared remote controller and receiver for 4 way 60x60 cassette - PY3 with panel.</p> <p>-----</p> <p>CZ-RWS3 + CZ-RWRY3</p>
 <p>Infrared remote controller and receiver for 4 way 90x90 cassette.</p> <p>-----</p> <p>CZ-RWS3 + CZ-RWRU3W</p>	 <p>Infrared remote controller and receiver for 2 way cassette.</p> <p>-----</p> <p>CZ-RWS3 + CZ-RWRL3</p>	 <p>Infrared remote controller and receiver for 1 way cassette.</p> <p>-----</p> <p>CZ-RWS3 + CZ-RWRD3</p>
 <p>Infrared remote controller and receiver for ceiling.</p> <p>-----</p> <p>CZ-RWS3 + CZ-RWRT3</p>	 <p>Infrared remote controller for wall-mounted and floor console.</p> <p>-----</p> <p>CZ-RWS3</p>	 <p>Infrared remote controller and receiver for all indoor units.</p> <p>-----</p> <p>CZ-RWS3 + CZ-RWRC3</p>

Accessories PCB

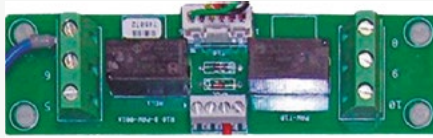

T10 interface PCB with digital and relay connections.

PAW-T10

PCB for fan speed control of external EC Fan.

PAW-ECF

R-22 Replacement Kit

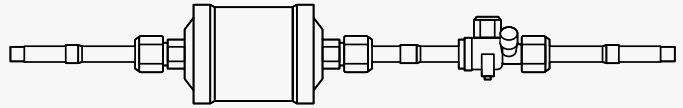

Replacement kit for R-22.

CZ-SLK2

Accessories cables

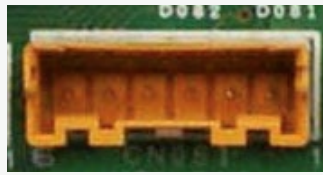

Cable for all the T10 functions.

CZ-T10



Cable to operate external EC fan.

PAW-FDC



Cable for all option monitoring signals.

PAW-OCT



Cable with force thermo OFF/leakage detection.

PAW-EXCT

Water heat exchanger accessories

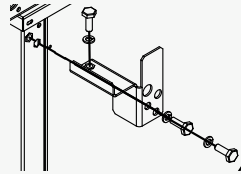

Stacking kit for vertically stacking up to 3 WHE (4 pieces per Kit).

PAW-3WSK

PRO-HT Tank accessories

Tank Controller for ECOi system.

PAW-VP-RTC5B-VRF

Expansion valve kit 28 kW.

PAW-VP-VALV-280

Smart fan coil accessories

Kits of 2 legs to protect the water pipings.

PAW-AAIR-LEGS-1

Motor connection cable for units with hydraulic connections on the right.

PAW-AAIR-RHCABLE

Fan coil accessories



Advanced wired remote controller for fan coil.

PAW-FC-RC1



Wired remote controller with touch control for 2-pipe, AC fan coil (control only).

PAW-FC-907AC



Wired remote controller for 2-pipe, AC fan coil (control only).

PAW-FC-903AC

2 way valve + drain pan for ducted models 010-060.

PAW-FC-2WY-11/55-1

2 way valve + drain pan for ducted models 070-080.

PAW-FC-2WY-65/90-1

2 way valve for wall-mounted.

PAW-FC2-2WY-K007

3 way valve + drain pan for ducted models 010-060.

PAW-FC-3WY-11/55-1

3 way valve + drain pan for ducted models 070-080.

PAW-FC-3WY-65/90-1

3 way valve for wall-mounted.

PAW-FC2-3WY-K007

1) Available in Autumn 2023.

Dimensions and tube sizes of branches and headers for 2-Pipe ECOi EX ME2 and Mini ECOi Series

Optional distribution joint kits

See the installation instructions packaged with the distribution joint kit for the installation procedure.

* In case the total capacity of indoor units connected after distribution exceeds the total capacity of the outdoor units, select the distribution piping size for the total capacity of the outdoor units.

Model name	Cooling capacity after distribution	Remarks
1. CZ-P680PH2BM	Up to 68,0 kW	For outdoor unit
2. CZ-P1350PH2BM	From 68,0 kW to 168,0 kW	For outdoor unit
3. CZ-P224BK2BM*	Up to 22,4 kW	For indoor unit
4. CZ-P680BK2BM*	From 22,4 kW to 68,0 kW	For indoor unit
5. CZ-P1350BK2BM*	From 68,0 kW to 168,0 kW	For indoor unit

Tubing size (with thermal insulation)

1. CZ-P680PH2BM: For outdoor unit side (capacity after distribution joint up to 68,0 kW).

Gas piping

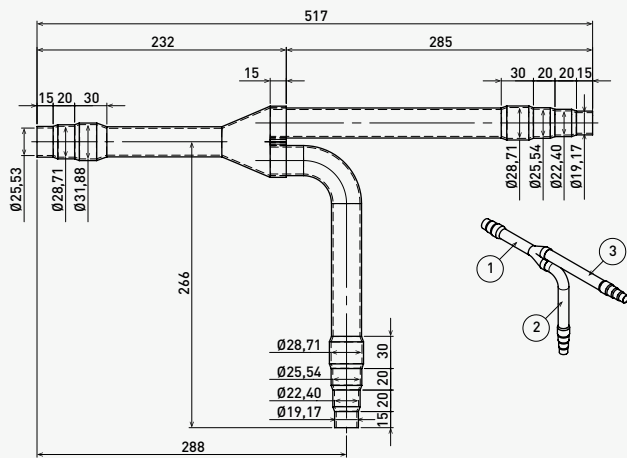

Liquid piping

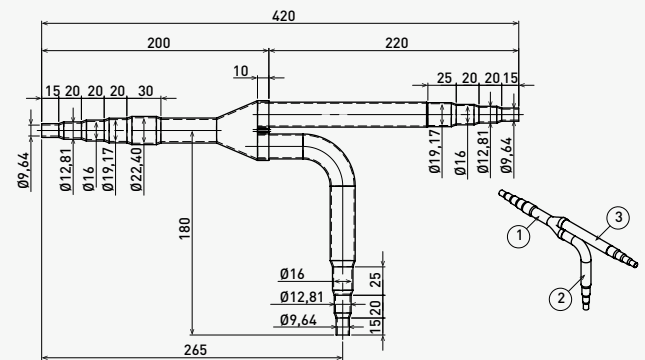

Unit: mm

2. CZ-P1350PH2BM: For outdoor unit side (capacity after distribution joint is from 68,0 kW to 168,0 kW).

Gas piping

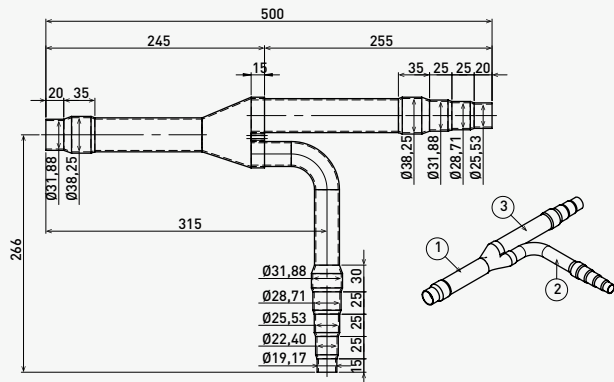

Liquid piping

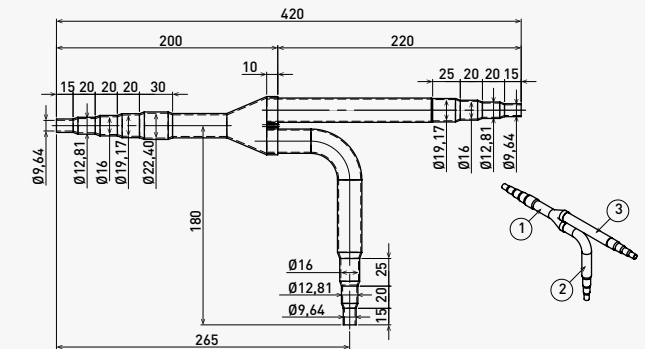

Unit: mm

3. CZ-P224BK2BM: For indoor unit side (capacity after distribution joint up to 22,4 kW).

Gas piping

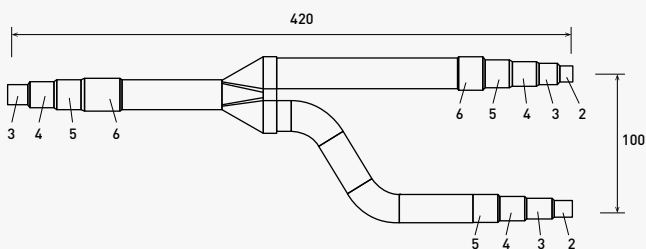

Liquid piping

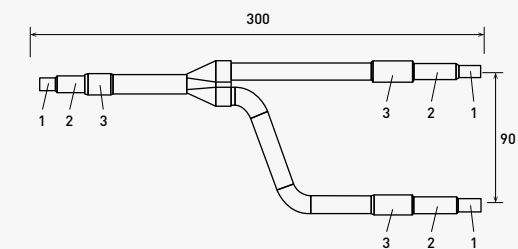

Unit: mm

4. CZ-P680BK2BM: For indoor unit side (capacity after distribution joint is from 22,4 kW to 68,0 kW).

Gas piping

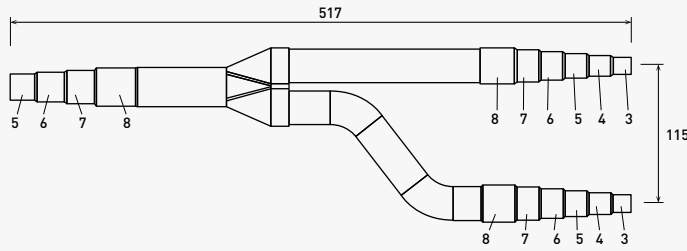

Liquid piping

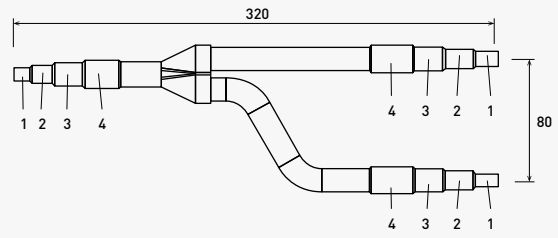

Unit: mm

5. CZ-P1350BK2BM: For indoor unit side (capacity after distribution joint is from 68,0 kW to 168,0 kW).

Gas piping

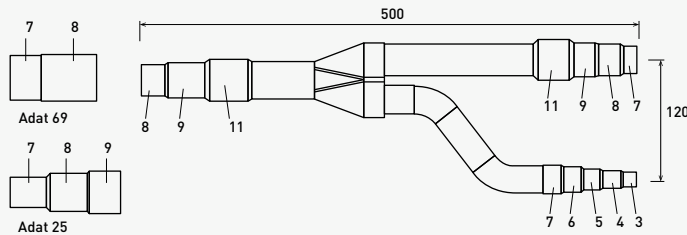

Liquid piping

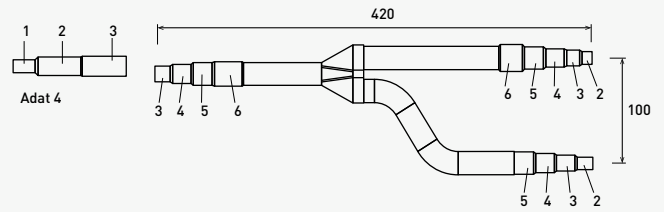

Unit: mm

Size of connection point on each part (shown are inside diameters of piping)

Diameters	1	2	3	4	5	6	7	8	9	10	11	12	13	14	
Dimension	Inch	1/4	3/8	1/2	5/8	3/4	7/8	1	1 1/8	1 1/4	1 3/8	1 1/2	1 5/8	1 3/4	2
	mm	6,35	9,52	12,70	15,88	19,05	22,40	25,40	28,57	31,75	34,92	38,10	41,28	44,45	50,80

Header pipe set

CZ-P4HP4C2BM

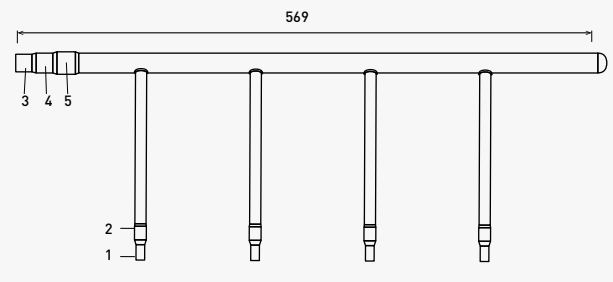
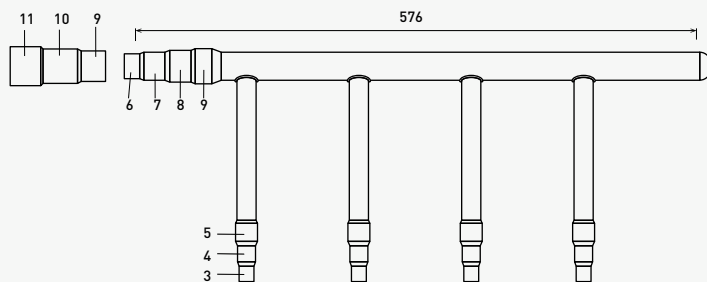

Size of connection point on each part (shown are inside diameters of piping)

Diameters	1	2	3	4	5	6	7	8	9	10	11	
Dimension	Inch	1/4	3/8	1/2	5/8	3/4	7/8	1	1 1/8	1 1/4	1 3/8	1 1/2
	mm	6,35	9,52	12,70	15,88	19,05	22,40	25,40	28,57	31,75	34,92	38,10

Distribution joint Kits for Mini ECOi LE/LZ Series

CZ-P224BK2BM: For indoor unit side (capacity after distribution joint up to 22,4 kW).

Gas piping

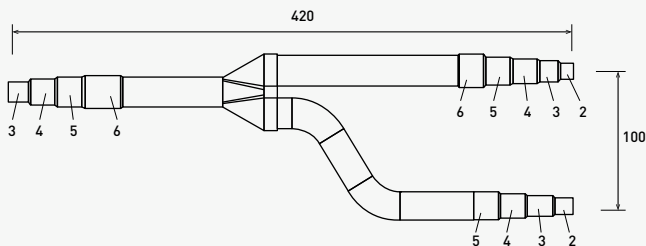

Liquid piping

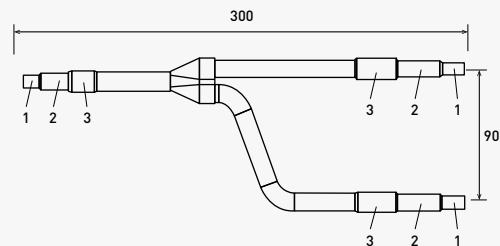

Unit: mm

Size of connection point on each part (shown are inside diameters of piping)

Diameters	1	2	3	4	5	6	
Dimension	Inch	1/4	3/8	1/2	5/8	3/4	7/8
	mm	6,35	9,52	12,70	15,88	19,05	22,40

Dimensions and tube sizes of branches and headers for 3-Pipe ECOi EX MF3 Series

Optional distribution joint kits

See the installation instructions packaged with the distribution joint kit for the installation procedure.

Model name	Cooling capacity after distribution	Remarks
1. CZ-P680PJ2BM	Up to 68,0 kW	For outdoor unit
2. CZ-P1350PJ2BM	From 68,0 kW to 135,0 kW	For outdoor unit
3. CZ-P224BH2BM	Up to 22,4 kW	For indoor unit
4. CZ-P680BH2BM	From 22,4 kW to 68,0 kW	For indoor unit
5. CZ-P1350BH2BM	From 68,0 kW to 135,0 kW	For indoor unit

Piping size

1. CZ-P680PJ2BM: For outdoor unit side (capacity after distribution joint up to 68,0 kW).

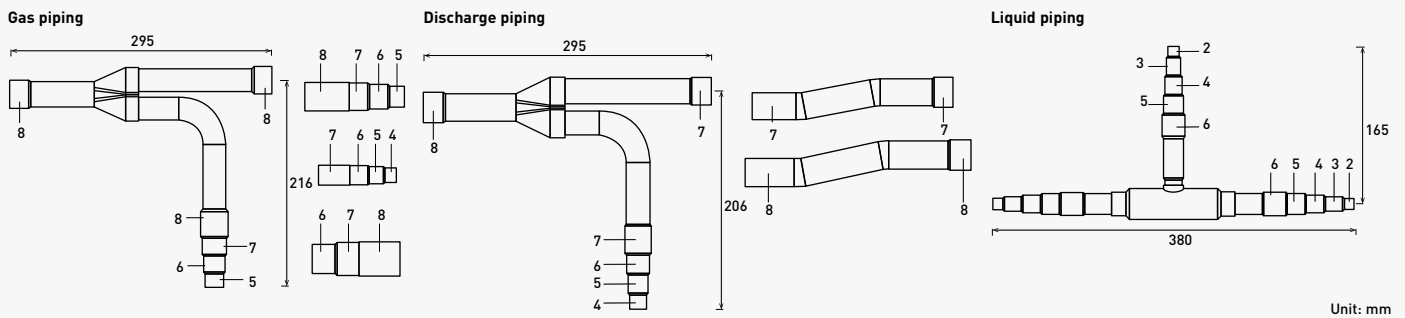

2. CZ-P1350PJ2BM: For outdoor unit side (capacity after distribution joint is from 68,0 kW to 135,0 kW).

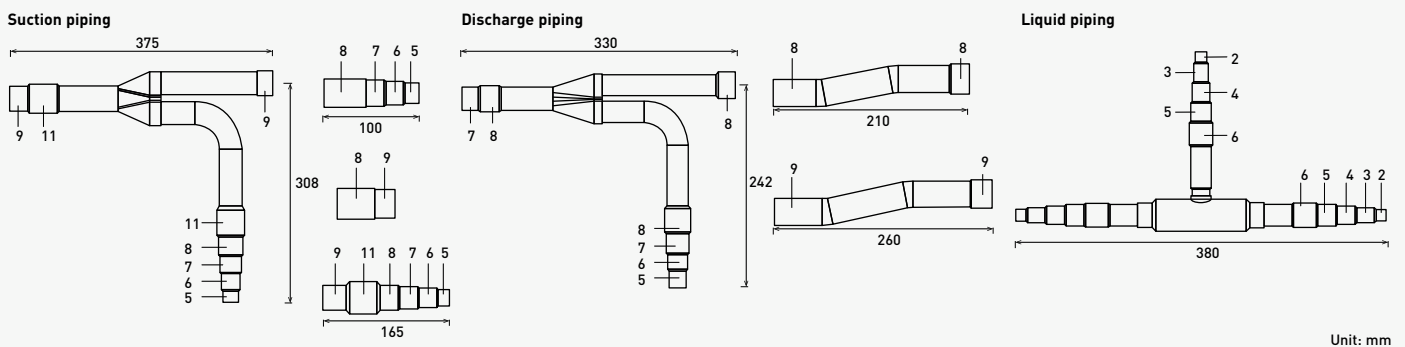

3. CZ-P224BH2BM: For indoor unit side (capacity after distribution joint up to 22,4 kW).

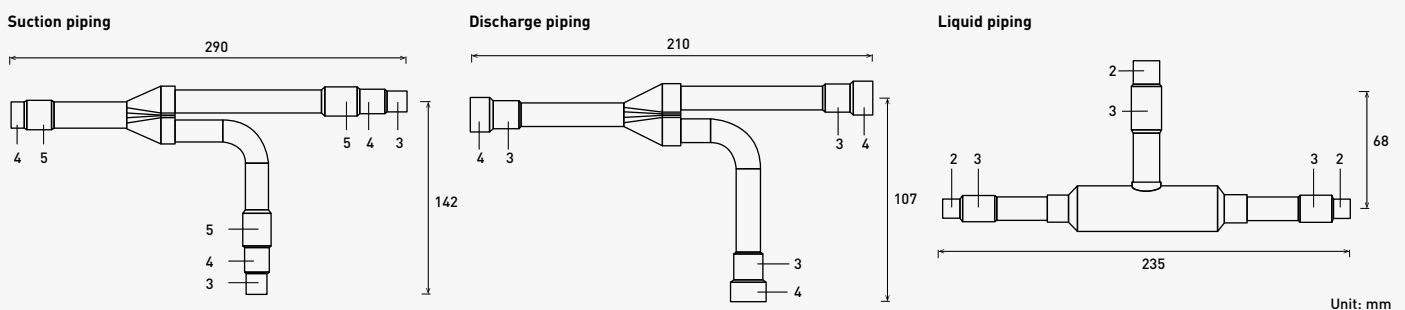

4. CZ-P680BH2BM: For indoor unit side (capacity after distribution joint is from 22,4 kW to 68,0 kW).

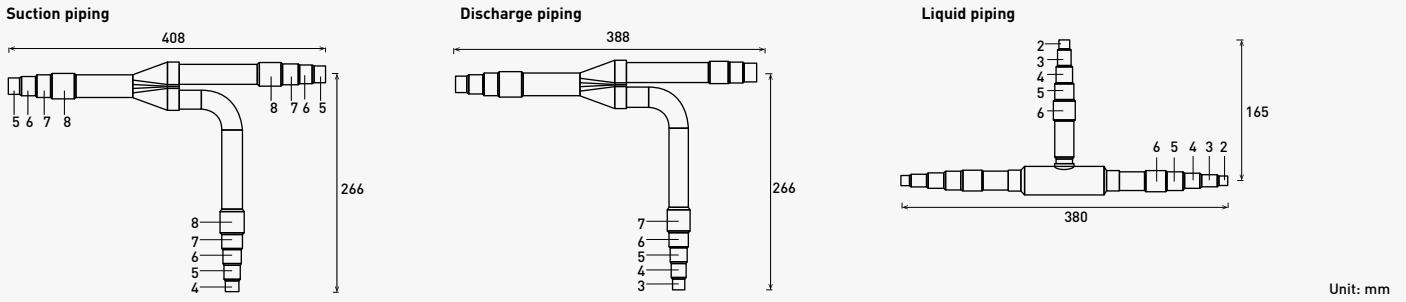

5. CZ-P1350BH2BM: For indoor unit side (capacity after distribution joint is from 68,0 kW to 135,0 kW).

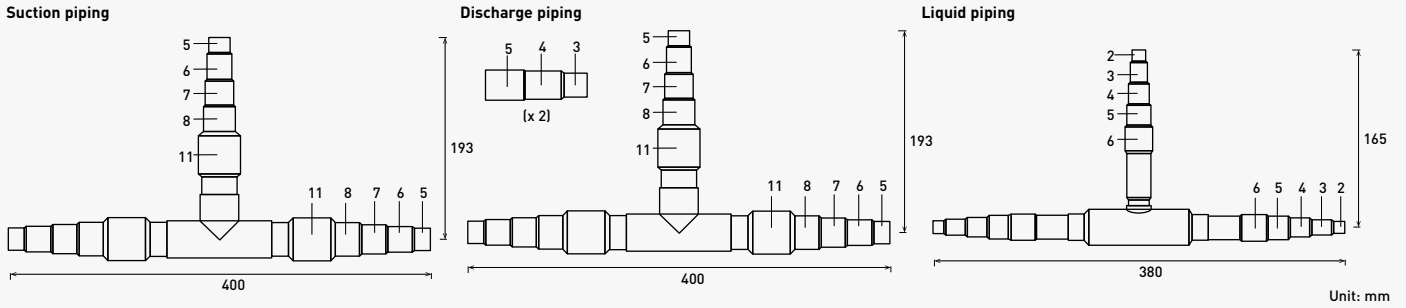

Size of connection point on each part (shown are inside diameters of piping)

Diameters	1	2	3	4	5	6	7	8	9	10	11	12	13	14
Inch	1/4	3/8	1/2	5/8	3/4	7/8	1	1 1/8	1 1/4	1 3/8	1 1/2	1 5/8	1 3/4	2
Dimension	mm	6,35	9,52	12,70	15,88	19,05	22,40	25,40	31,75	34,92	38,10	41,28	44,45	50,80

Header pipe set

CZ-P4HP3C2BM

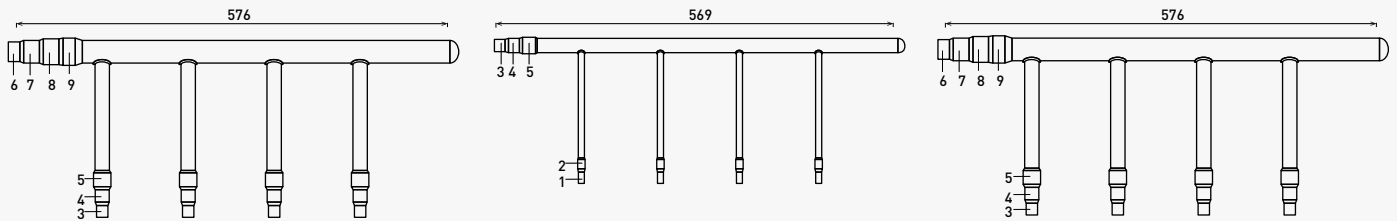

Size of connection point on each part (shown are inside diameters of piping)

Diameters	1	2	3	4	5	6	7	8	9	10	11	
Inch	1/4	3/8	1/2	5/8	3/4	7/8	1	1 1/8	1 1/4	1 3/8	1 1/2	
Dimension	mm	6,35	9,52	12,70	15,88	19,05	22,40	25,40	28,57	31,75	34,92	38,10



Panasonic ventilation solutions

Panasonic ventilation solutions for maximum savings and easy integration.

Air handling unit kit → 340

AHU connection kit 3,6 to 28,0 kW for PACi NX and PACi → 342

AHU connection kit 14,0 to 189,0 kW for ECOi and ECO G → 344

Energy recovery ventilation → 346

New advanced energy recovery ventilation ZY Series → 347

Energy recovery ventilation ZDY Series → 348

Heat recovery with DX coil for VRF → 350

Heat recovery with DX coil · R410A → 351

Electric air curtains → 352

Electric air curtain → 352

Air curtain with DX coil, connected to PACi NX and PACi → 354

Air curtain with DX coil, connected to VRF systems → 355

High pressure duct and 100% fresh air duct function → 356

E2 type high static pressure hide-away · R410A → 357

Ceiling mounted air-e nanoe X Generator → 358

Ceiling mounted air-e nanoe X Generator → 359

Residential ventilation

Heat recovery ventilation unit → 360

Counter flow ventilation → 362

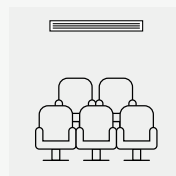
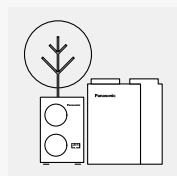
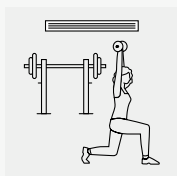
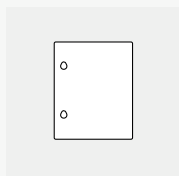

Air handling unit kit

AHU connection kits connect outdoor units to air handling systems. Combines air conditioning and fresh air in just one solution.

Application: Hotels, offices, server rooms or all large buildings where air quality control, such as humidity control and fresh air, is needed.



AHU connection kit for PACi, ECOi and ECO G.

PACi NX and PACi: 3,6 to 28,0 kW.

ECOi and ECO G: 16, 28 and 56 kW.

- Durable metal casing (IP66) allows external installation
- 0-10 V demand control
- CONEX Bluetooth® control built-in (CZ-RTC6BL)
- Panasonic H&C Control App via Bluetooth®
- Easy integration to BMS

PACi / ECOi EX / ECOi / ECO G

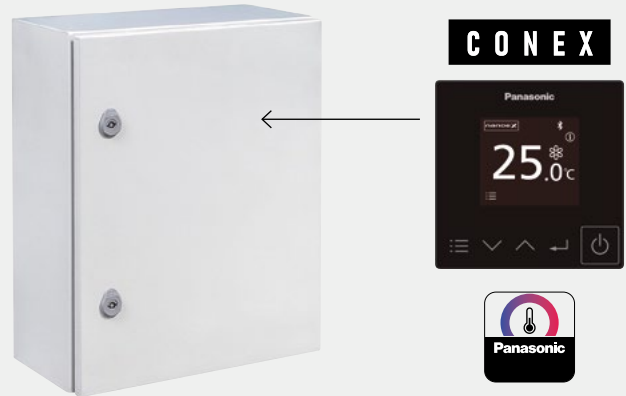

The Panasonic AHU connection kits offer a wealth of connectivity possibilities, integrating easily into many systems.

Besides the advantages in terms of indoor air quality, air conditioning offers also an energy saving potential. For example, uncontrolled ventilation through open windows leads to large amounts of heat being lost to the outside during the heating season or gained from the outside during the cooling season. Whereas, combining heat recovery with air conditioning can allow for a high level of comfort whilst reducing the overall operating costs of running air conditioning alone. The larger area of the comfort range, the better the energy saving opportunities.

Panasonic AHU connection kit connected to outdoor unit

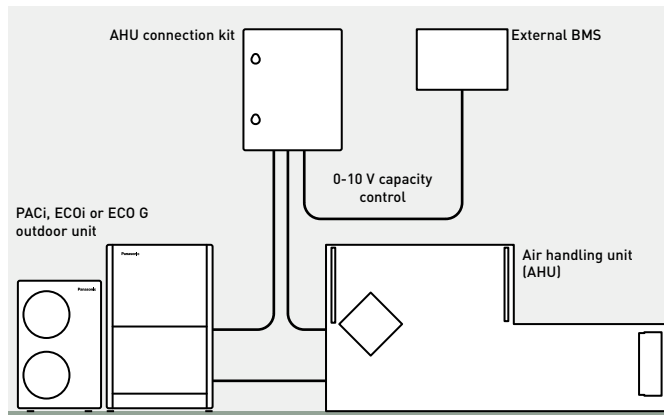

Demand control on the outdoor unit managed by external 0-10 V signal.

- AHU connection kit contains: IP66 box with PCBs and terminal connections mounted inside, expansion valve and sensors
- Heat exchanger, fan and fan motor to be mounted in the AHU itself are field supplied

Main components of mechanical ventilation systems

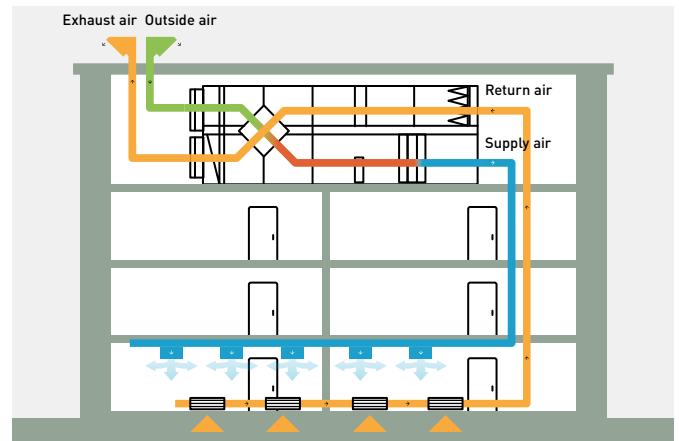

- Air handling unit (AHU)
- Air ducts
- Air distribution elements

Optional parts: Following functions are available by using different control accessories:

Timer remote controller.
CZ-RTC5B.



DC 12 V outlet. Option terminal.
PAW-OCT.



Mini seri-para I/O unit.
CZ-CAPBC2
Advanced version only.



PCB to connect to T10 connector.
CZ-T10 terminal / PAW-T10 PCB



AHU connection kit 3,6 to 28,0 kW for PACi NX and PACi

Compatible with R32 or R410A outdoor units.



AHU connection kit

Reference	IP66	0-10 V demand control*
PAW-280PAH3M-1	Yes	Yes

* With CZ-CAPBC2.

Control options

Control option 1.

- The system's control is simple: control of actual suction temperature vs. set point
- Control works in the same way as that of any indoor unit
- Fan signal issued by the PCB (OFF while defrosting, for instance)

Control option 2.

- System control by a 0-10 V control working from an external BMS that manages the set point for temperature or capacity. Enhances efficiency by adjusting capacity and enhances comfort as well
- All signals as standard

0-10 V control

With the 0-10 V demand control the capacity of the outdoor unit can be controlled by 20 steps.

Input voltage* [V]	0	1,0	1,5	2,0	2,5	3,0	3,5	4,0	4,5	5,0	5,5	6,0	6,5	7,0	7,5	8,0	8,5	9,0	9,5
Demand (% of nominal current)	No cut ¹⁾	40	45	50	55	60	65	70	75	80	85	90	95	100	105	110	115	120	No limit / Full capacity ²⁾
Indoor unit start / stop	Stop ¹⁾															Start			

¹⁾ No cut / stop: AHU system / indoor unit is completely switched OFF.

²⁾ No limit: No restrictions applied by BMS to AHU system / indoor unit performance [equivalent to "full-load operation" of AHU system / indoor unit].



AHU connection kit 3,6 to 28,0 kW for PACi NX and PACi

PAW-280PAH3M-1			3,6 kW	5,0 kW	6,0 kW	7,5 kW	10,0 kW	12,5 kW	14,0 kW	20,0 kW	25,0 kW
Cooling capacity		kW	3,6	5,0	6,0	7,1	10,0	12,5	14,0	19,5	23,2
Heating capacity		kW	4,0	5,6	7,0	8,0	11,2	14,0	16,0	22,4	28,0
Air flow	Min / Max	m ³ /h	540/870	630/990	780/1320	780/1320	900/2160	1140/2280	1200/2400	2160/4320	2280/5040
Dimension	HxWxD	mm	500x400 x150	500x400 x150	500x400 x150	500x400 x150	500x400 x150	500x400 x150	500x400 x150	500x400 x150	500x400 x150
Net weight		kg	11,5	11,5	11,5	11,5	11,5	11,5	11,5	11,5	11,5
Pipe length range	Standard	m	3~15	3~20	3~40	3~40	5~50	5~50	5~50	—	—
	Elite	m	3~40	3~40	3~40	5~50	5~85	5~85	5~85	5~90	5~60
Elevation difference (in / out)	Max	m	30	30	30	30	30	30	30	30	30
Piping diameter	Liquid	Inch (mm)	1/4 (6,35)	1/4 (6,35)	3/8 (9,52)	3/8 (9,52)	3/8 (9,52)	3/8 (9,52)	3/8 (9,52)	3/8 (9,52)	1/2 (12,70)
	Gas	Inch (mm)	1/2 (12,70)	1/2 (12,70)	5/8 (15,88)	5/8 (15,88)	5/8 (15,88)	5/8 (15,88)	5/8 (15,88)	1 (25,40)	1 (25,40)
Intake temperature of AHU connection kit	Cool Min ~ Max	°C DB	18~32	18~32	18~32	18~32	18~32	18~32	18~32	18~32	18~32
	Cool Min ~ Max	°C WB	14~25	14~25	14~25	14~25	14~25	14~25	14~25	—	—
	Heat Min ~ Max	°C	16~30	16~30	16~30	16~30	16~30	16~30	16~30	16~30	16~30
Ambient temperature of outdoor unit (Standard)	Cool Min ~ Max	°C	-10~+43	-10~+43	-10~+43	-10~+43	-10~+43	-10~+43	-10~+43	-10~+43	-10~+43
	Heat Min ~ Max	°C	-15~+24	-15~+24	-15~+24	-15~+24	-15~+24	-15~+24	-15~+24	-15~+24	-15~+24
Ambient temperature of outdoor unit (Elite)	Cool Min ~ Max	°C	-15~+46	-15~+46	-15~+46	-15~+46	-20~+48	-20~+48	-20~+48	-20~+48	-20~+48
	Heat Min ~ Max	°C	-20~+24	-20~+24	-20~+24	-20~+24	-20~+24	-20~+24	-20~+24	-20~+24	-20~+24

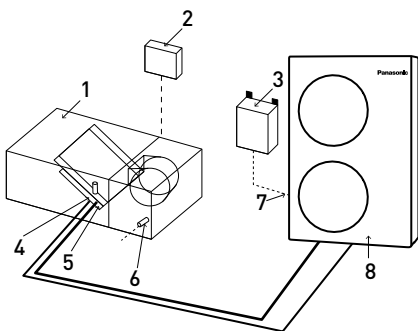

System and regulations. System overview.

- 1 | AHU equipment (field supplied)
- 2 | AHU system controller (field supplied)
- 3 | AHU connection kit controller box (with control PCB)
- 4 | Thermistor for gas pipe (E2)
- 5 | Thermistor for liquid pipe (E1)
- 6 | Thermistor for suction air
- 7 | Inter-unit wiring
- 8 | Outdoor unit

AHU connection kit.



PCB, power trans, terminal block.



Thermistor x2 (refrigerant: E1, E2).

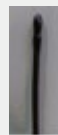

Thermistor (air: TA; 1 sensor).



Wired remote controller. CZ-RTC6BL

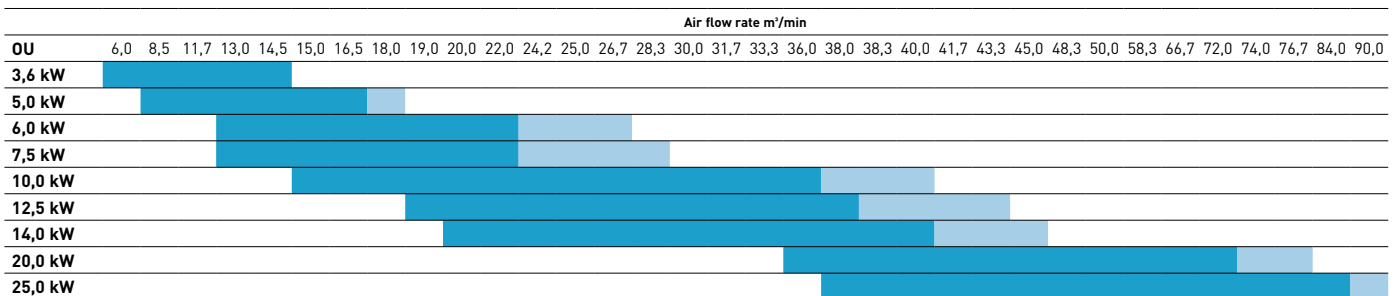

Standard range of air flow rate under standard conditions (air intake temperature in cooling mode from 18 to 32 °C DB).

Extended range of air flow rate under special conditions (air intake temperature in cooling mode from 18 to 30 °C DB).

New AHU connection kit 14,0 to 189,0 kW for ECOi and ECO G



AHU connection kit

Reference	IP66	0-10 V demand control*
PAW-160MAH3M / PAW-280MAH3M / PAW-560MAH3M	Yes	Yes

* With CZ-CAPBC2.

With ECOi outdoor units

ECOi outdoor units shall be used for AHU connection kit. 3 models for VRF system: 5 HP (PAW-160MAH3M), 10 HP (PAW-280MAH3M) and 20 HP (PAW-560MAH3M).

With ECO G outdoor units

- One AHU connection kit may be used for one ECO G unit. Multiple AHU connection kits cannot be used
- Mixed with standard indoor units is not allowed
- Power specifications are single phase 220 V to 240 V

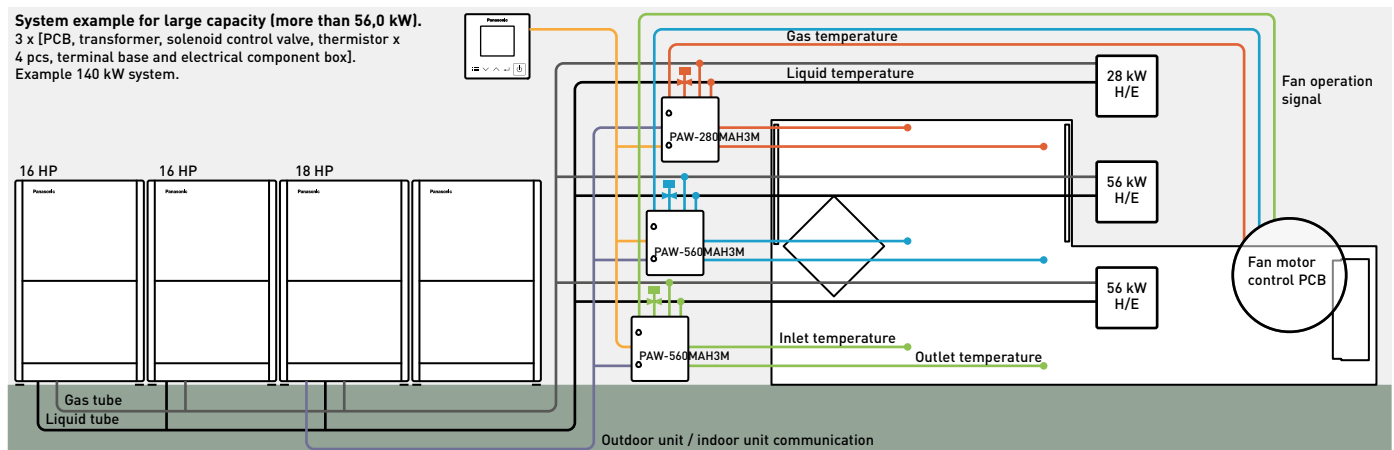



NEW AHU connection kit 14,0 to 189,0 kW for ECOi and ECO G

Reference	PAW-	5 HP	10 HP	20 HP	30 HP	40 HP	50 HP	60 HP
		160MAH3M	280MAH3M	560MAH3M	280MAH3M 560MAH3M	560MAH3M 560MAH3M	560MAH3M 560MAH3M 280MAH3M	560MAH3M 560MAH3M
Cooling capacity	kW	14,0	28,0	56,0	84,0	112,0	140,0	168,0
Heating capacity	kW	16,0	31,5	63,0	95,0	127,0	155,0	189,0
Air flow	Cool Min/Max m³/h	2598/1140	4998/3498	10002/7002	15000/10500	19998/13998	24996/17496	30000/21000
Bypass factor recommended		0,9	0,9	0,9	0,9	0,9	0,9	0,9
Dimension	H x W x D mm	278 x 278 x 180	278 x 278 x 180	278 x 278 x 180	278 x 278 x 180	278 x 278 x 180	278 x 278 x 180	278 x 278 x 180
Net weight	kg	3,2	6,3	6,3	6,3	6,3	6,3	6,3
Pipe length range	m	10 ~ 100	10 ~ 100	10 ~ 100	10 ~ 100	10 ~ 100	10 ~ 100	10 ~ 100
Elevation difference (in / out)	Max m	10	10	10	10	10	10	10
Piping diameter	Liquid Inch (mm)	3/8(9,52)	3/8(9,52)	5/8(15,88)	3/4(19,05)	3/4(19,05)	3/4(19,05)	3/4(19,05)
	Gas Inch (mm)	5/8(15,88)	7/8(22,22)	1 1/8(28,58)	1 1/4(31,75)	1 1/2(38,15)	1 1/2(38,15)	1 1/2(38,15)
Intake temperature of AHU connection kit	Cool Min ~ Max °C DB	+18 ~ +32	+18 ~ +32	+18 ~ +32	+18 ~ +32	+18 ~ +32	+18 ~ +32	+18 ~ +32
	Cool Min ~ Max °C WB	+13 ~ +23	+13 ~ +23	+13 ~ +23	+13 ~ +23	+13 ~ +23	+13 ~ +23	+13 ~ +23
	Heat Min ~ Max °C	+16 ~ +30	+16 ~ +30	+16 ~ +30	+16 ~ +30	+16 ~ +30	+16 ~ +30	+16 ~ +30
Ambient temperature of outdoor unit	Cool Min ~ Max °C	-10 ~ +43	-10 ~ +43	-10 ~ +43	-10 ~ +43	-10 ~ +43	-10 ~ +43	-10 ~ +43
	Heat Min ~ Max °C	-20 ~ +15	-20 ~ +15	-20 ~ +15	-20 ~ +15	-20 ~ +15	-20 ~ +15	-20 ~ +15

AHU connection kit / system combination

Capacity		ECOi Series			AHU kit			Capacity	ECO G Series		AHU kit
5 HP	16 kW	All ECOi			160MAH3	—	—	5 HP	16 kW	All ECO G	160MAH3
10 HP	28 kW	U-10ME2E8	—	—	280MAH3	—	—	10 HP	28 kW	All ECO G	280MAH3
20 HP	56 kW	U-20ME2E8	—	—	560MAH3	—	—	20 HP	56 kW	U-20GE3E5	560MAH3
30 HP	84 kW	U-16ME2E8	U-14ME2E8	—	560MAH3	280MAH3	—				
40 HP	112 kW	U-20ME2E8	U-20ME2E8	—	560MAH3	560MAH3	—				
50 HP	140 kW	U-18ME2E8	U-16ME2E8	U-16ME2E8	560MAH3	560MAH3	280MAH3				
60 HP	168 kW	U-20ME2E8	U-20ME2E8	U-20ME2E8	560MAH3	560MAH3	560MAH3				

Technical focus

- Maximum capacity / system: 60 HP (189 kW)
- Maximum piping length: 100 m (120 m equivalent)
- Elevation difference (indoor unit / indoor unit): 4 m
- In / out capacity ratio: 50~100%
- Maximum number of AHU connection kits: 3 units*
- Outdoor temperature range in heating: -20 ~ +15 °C
- Available temperature range for the suction air at AHU connection kit: cool: +18 ~ +32 °C / heat: +16 ~ +30 °C
- The systems is controlled by the suction air (or room return air) temperature (same as standard indoor unit)
- The discharge air temperature is also controlled to prevent too-low air discharge in cooling or too-high air discharge in heating (in case of VRF)
- Demand control (forcible thermostat-OFF control by operating current)
- Defrost operation signal, Thermo-ON / OFF states output
- Drain pump control (drain-pump and the float switch to be supplied in local)
- External target temperature setting via indoor / outdoor signal interface is available with CZ-CAPBC2 (Ex. 0-10 V)
- Demand control 40% to 120% (5% steps) by 0-10 V input signal

- Connectable with S-Link system. Special care for electrical noise may be necessary depending on the on-site system
- Fan control signal from the PCB can be used to control the air flow (high / mid / low and LL for Th-OFF). Need to change the fan control circuit wiring at field

* To be simultaneous operation controlled by one remote controller sensor.

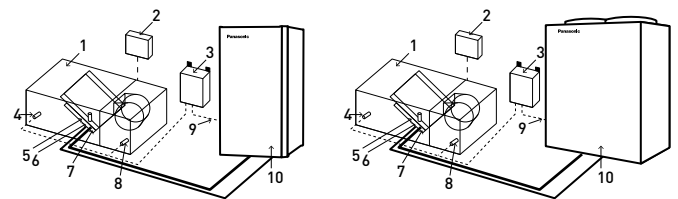

System and regulations. System overview.

- 1 | AHU Unit equipment (field supplied)
- 2 | AHU Unit system controller field supplied
- 3 | AHU connection kit controller box (with control PCB)
- 4 | Thermistor for discharge air
- 5 | Electronic expansion valve
- 6 | Thermistor for gas pipe [E3]
- 7 | Thermistor for liquid pipe [E1]
- 8 | Thermistor for suction air
- 9 | Inter-unit wiring
- 10 | Outdoor unit

Energy recovery ventilation

Indoor air quality (IAQ) is a key consideration for any business owner looking to create a healthy and comfortable environment. An energy recovery ventilator (ERV) provides balanced, energy-efficient ventilation by transferring heat and moisture between incoming fresh filtered air and outgoing stale air. In the winter, an ERV keeps heat and moisture inside the building. During hot, humid summer months, it maintains cool, dry indoor air.



New advanced ERV ZY Series.

- Extended 9 model line-up including 2000 m³/h model
- DC motors
- ESP up to 150 Pa
- F7 grade filter built-in as a standard
- New intuitive remote controller
- BMS integration with RS485



ERV ZDY Series.

- Simple 5 line-up
- AC motor
- A nonwoven cloth filter
- Simple wired remote controller with black panel



New advanced energy recovery ventilation ZY Series



Recovers up to 83% of the heat in the outgoing air

ZY Series achieves more than 80% of heat exchange efficiency in all the line-up ¹⁾. The high recovery rate optimizes operation cost and can be considered as a sustainable solution.

1) Heating operation, H1 speed setting.

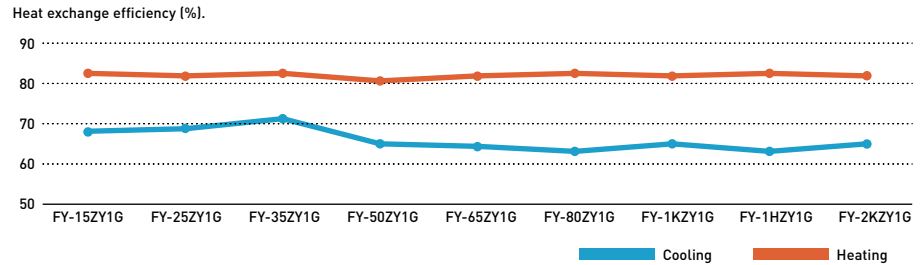

Ventilation volume setting PQ curve example.

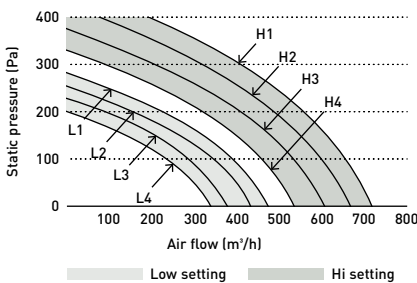

Easy adjust for air volume balance

DC motors are equipped with independent control settings for air supply and exhaust. Air volume balance can be easily adjusted with 4 speeds settings for each Hi / Low operation.

Highly efficient filter for better air supply

An effective EN F7 grade filter is built-in as a standard.

Expected cleaning maintenance cycle is once per month, with an average of 4-6 months for replacement in high demand environments.

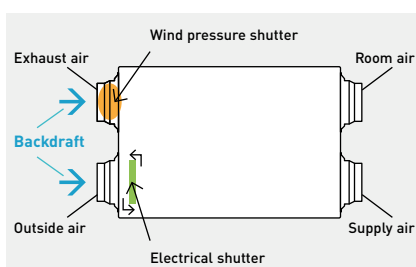

Backdraft shutters equipped as standard

A backdraft shutter prevents air flowing in the wrong direction when the ERV system is not in operation.

The shutter at OA (outside air intake) side is inter-locked with ON / OFF switch. The shutter at EA (exhaust air outlet) side opens with the pressure generated by air stream then closes automatically.

New intuitive remote controller with RS485 connection

- Simple and clean screen with white back light panel
- RS485 terminal equipped to integrate with Building Management Systems
- Metal switch box is included in the package

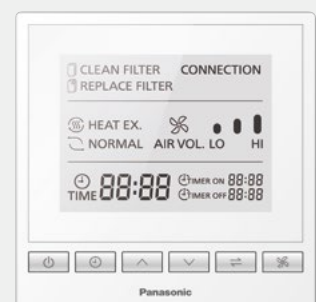

Energy recovery ventilation ZDY Series



Energy efficiency and ecology

Energy consumption is dramatically reduced by using a counter-flow heat-exchange element. Air conditioning load is reduced by approximately 20%, resulting in significant energy savings.

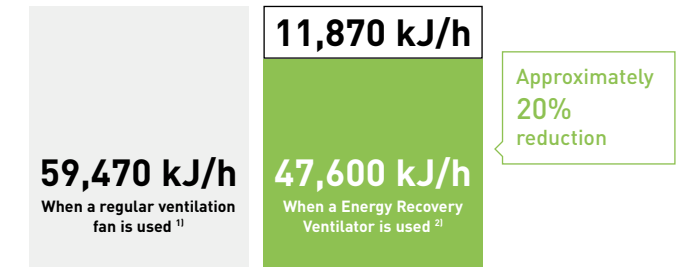

1) Two FY-27FPK7 units. 2) One FY-500ZDY8R unit.

Comparison of former and current elements

With the counter-flow element, air flows through the element for a longer time (longer distance) than the former cross-flow element, so the heat-exchange effect remains unchanged even if the element is made thinner.

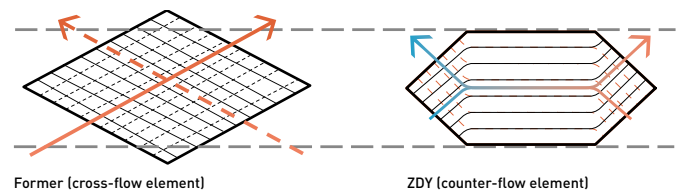

More comfort

Quiet operation.

Low noise operation results in noticeably quieter units. All models with capacities below 500 m³/h run at noise levels below 32 dB (high setting) and even our largest 1000 m³/h-capacity model runs at only 37,5 dB (high setting).

Long service life of heat-exchange element

A nonwoven cloth filter has a high dust collection efficiency and redesigned the air flow passages to achieve a durable heat-exchange element. Cleaning can be reduced to every 6 months.

Reverse mountable direct air supply / exhaust system

Adoption of straight air supply / exhaust system: Duct design is simplified because the air supply / exhaust ducts are straight.

Since each unit can be mounted in reverse position, only one inspection hole is needed for two units: Two units can share one inspection hole so duct work is easier and more flexible.

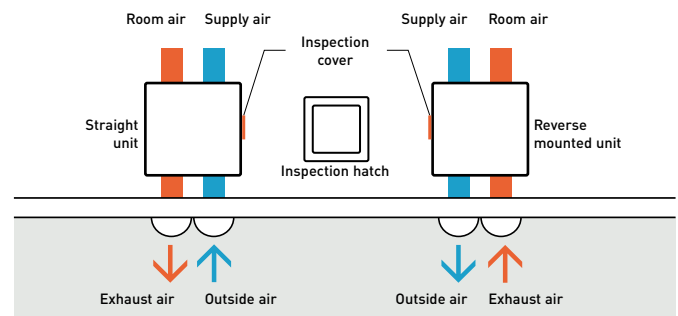

A intuitive and stylish control

- Wire controller included as standard
- Compact and flat front panel
- Filter cleaning support
 - Signal alert for clearing
 - Filter usage condition by 1/2/3/4 months
- Size (W x H x D) 116 x 120 x 40 mm



NEW advanced energy recovery ventilation



Rated flow rate			150 m ³ /h	250 m ³ /h	350 m ³ /h	500 m ³ /h	650 m ³ /h	800 m ³ /h	1000 m ³ /h	1500 m ³ /h	2000 m ³ /h
Indoor unit			FV-15ZY1G	FV-25ZY1G	FV-35ZY1G	FV-50ZY1G	FV-65ZY1G	FV-80ZY1G	FV-1KZY1G	FV-1HZY1G	FV-2KZY1G
Power supply	Voltage	V	220 - 240	220 - 240	220 - 240	220 - 240	220 - 240	220 - 240	220 - 240	220 - 240	220 - 240
	Phase		Single phase	Single phase	Single phase	Single phase	Single phase	Single phase	Single phase	Single phase	Single phase
	Frequency	Hz	50	50	50	50	50	50	50	50	50
Motor type			DC	DC	DC	DC	DC	DC	DC	DC	DC
ERV											
Air flow	Max	m ³ /h	150	250	350	500	650	800	1000	1500	2000
External static pressure	Max	Pa	100	120	140	130	150	150	150	130	130
Sound power ²⁾	Max	dB(A)	37	38	39	43	45	45	46	49	51
Input power	Max	W	76 - 84	106 - 117	141 - 155,5	180 - 198	420 - 462	470 - 517	550 - 605	940 - 1034	1100 - 1210
Heat exchange efficiency ³⁾											
Cooling	Max	%	68,0	69,0	71,0	65,0	64,0	63,0	65,0	63,0	65,0
Heating	Max	%	83,0	82,0	83,0	81,0	82,0	83,0	82,0	83,0	82,0
Enthalpy exchange efficiency											
Cooling	Max	%	66,0	66,0	67,0	62,5	62,5	63,5	63,0	63,5	63,0
Heating	Max	%	76,0	74,0	75,0	73,0	72,0	73,0	74,0	73,0	74,0
Adapter diameter		mm	100	150	150	200	200	250	250	250	250
Dimension ³⁾	HxWxD	mm	289 x 610 x 860	289 x 735 x 860	331 x 874 x 968	331 x 1016 x 968	404 x 954 x 1008	404 x 1004 x 1224	404 x 1231 x 1224	808 x 1004 x 1224	808 x 1231 x 1224
Net weight		kg	23	27	37	40	48	56	64	116	139

1) Different dimensions depending on models. 2) Measurement of noise 1,5 m below the center of the main unit (anechoic chamber). 3) Heat exchange efficiency measurement standard JIS B 8628 (2003). * JIS B 8628 (2017) is used in the measurement environment. ** Available in Autumn 2023. *** Remote controller image is tentative.

Accessories	
FV-FP15ZY1G	Replacement high efficiency filter for FV-15ZY1G
FV-FP25ZY1G	Replacement high efficiency filter for FV-25ZY1G
FV-FP35ZY1G	Replacement high efficiency filter for FV-35ZY1G
FV-FP50ZY1G	Replacement high efficiency filter for FV-50ZY1G

Accessories	
FV-FP65ZY1G	Replacement high efficiency filter for FV-65ZY1G
FV-FP80ZY1G	Replacement high efficiency filter for FV-80ZY1G and FV-1HZY1G*
FV-FP1KZY1G	Replacement high efficiency filter for FV-1KZY1G and FV-2KZY1G*

* 2 sets of filters required for those models.

Energy recovery ventilation

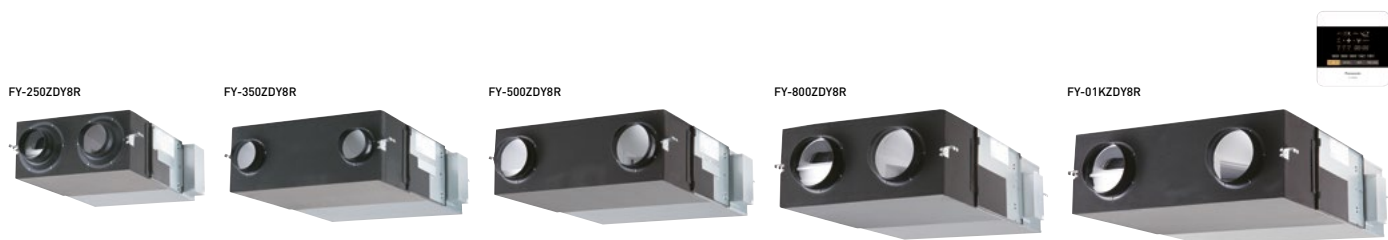

Rated flow rate			250 m ³ /h			350 m ³ /h			500 m ³ /h			800 m ³ /h			1000 m ³ /h		
Indoor unit			FY-250ZDY8R			FY-350ZDY8R			FY-500ZDY8R			FY-800ZDY8R			FY-01KZDY8R		
Power supply	Voltage	V	220 - 240			220 - 240			220 - 240			220 - 240			220 - 240		
	Phase		Single phase			Single phase			Single phase			Single phase			Single phase		
	Frequency	Hz	50			50			50			50			50		
Notch			Extra high	High	Low	Extra high	High	Low	Extra high	High	Low	Extra high	High	Low	Extra high	High	Low
	Input power	W	112,0 - 128,0	108,0 - 123,0	87,0 - 96,0	182,0 - 190,0	178,0 - 185,0	175,0 - 168,0	263,0 - 289,0	204,0 - 225,0	165,0 - 185,0	387,0 - 418,0	360,0 - 378,0	293,0 - 295,0	437,0 - 464,0	416,0 - 432,0	301,0 - 311,0
Air flow		m ³ /h	250	250	190	350	350	240	500	500	440	800	800	630	1000	1000	700
External static pressure		Pa	105	95	45	140	60	45	120	60	35	140	110	55	105	80	75
Sound power	Heat exchange	dB(A)	30,0 - 31,5	29,5 - 30,5	23,5 - 26,5	32,5 - 33,0	30,5 - 31,0	22,5 - 25,5	36,5 - 37,5	34,5 - 35,5	31,0 - 32,5	37,0 - 37,5	36,5 - 37,0	33,5 - 34,5	37,5 - 38,5	37,0 - 37,5	33,5 - 34,5
	Normal	dB(A)	30,0 - 31,5	29,5 - 30,5	23,5 - 26,5	32,5 - 33,0	30,5 - 31,0	22,5 - 25,5	37,5 - 38,5	37,0 - 38,0	31,0 - 32,5	37,0 - 37,5	36,5 - 37,0	33,5 - 34,5	39,5 - 40,5	39,0 - 39,5	35,5 - 36,5
Temperature exchange efficiency		%	75	75	77	75	75	78	75	75	76	75	75	76	75	75	79
Dimension	HxWxD	mm	270x599x882			317x804x1050			317x904x1090			388x884x1322			388x1134x1322		
Net weight		kg	29			49			57			71			83		

The noise level was measured within an acoustic chamber. Due to installation arrangement and surfaces within the space, actual noise levels may increase. The input, the current and the exchange efficiency are values relevant to the indicated air flows. The noise level is measured 1,5 m below the centre of the unit. The temperature exchange efficiency is an average of both cooling and heating operation.

Heat recovery with DX coil for VRF

Panasonic heat recovery solution for greater energy efficiency. Performing well in extreme weather conditions, it can achieve up to 77% efficiency (63% in enthalpy efficiency).



The counter-flow heat exchanger reduces the air conditioning load, enabling customers – typically owners of hotels, restaurants and other large commercial buildings – to reduce their energy consumption and save on the cost of maintaining comfortable room temperatures.

Energy efficiency

These heat recovery devices are an example of Panasonic's continued commitment to developing unbeatable, energy-efficient air conditioning technologies for commercial applications.

The unit features a DX coil, and is designed to recover up to 77% of the heat from outgoing air, and an air purifying system which helps to improve air quality. In even the most demanding commercial applications, business owners will benefit from the unit's ability to by-pass the heat exchange process when the outside air temperature is cool enough for fresh air to be drawn directly inside (free cooling). This alleviates the load on the air conditioning equipment and consequently reduces energy bills.

Balanced ventilation

Supply section complete

The supply section comes complete with the DX coil (using R410A refrigerant) – fitted with a solenoid control valve, freon filter, contact temperature sensors on the liquid and gas line, and NTC sensors on the upstream and downstream air flows. The built-in electric box is equipped with a PCB to control the internal fan speed and to interconnect the outdoor and indoor units, and the ducts are connected by circular plastic collars.

Characteristic curves

The following curves show the unit external static pressure at maximum fan speed for each model.

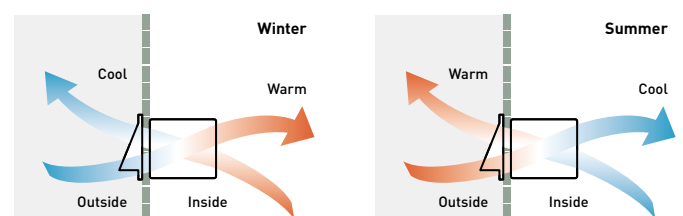
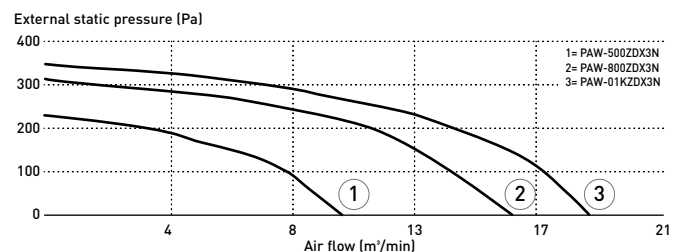

Heat recovery with DX coil · R410A

Motorised heat recovery by-pass device automatically controlled to use fresh air free-cooling when convenient.



+ COMPATIBLE WITH ALL PANASONIC CONNECTIVITY SOLUTIONS. FOR DETAILED INFORMATION GO TO THE CONTROL SYSTEMS SECTION

Indoor unit			PAW-500ZDX3N	PAW-800ZDX3N	PAW-01KZDX3N			
Power supply	Voltage	V	230	230	230			
	Phase		Single phase	Single phase	Single phase			
	Frequency	Hz	50	50	50			
Air flow		m ³ /min	8,3	13,3	16,7			
External static pressure ¹⁾		Pa	90	120	115			
Maximum current	Total full load	A	0,6	1,4	2,1			
		W	150	320	390			
Input power		W	150	320	390			
Sound pressure ²⁾		dB(A)	39	42	43			
	Piping diameter	Liquid	Inch (mm)	1/4 (6,35)	1/4 (6,35)	1/4 (6,35)		
Gas		Inch (mm)	1/2 (12,70)	1/2 (12,70)	1/2 (12,70)			
Heat recovery			Cooling	Heating	Cooling	Heating	Cooling	Heating
Temperature efficiency		%	76	76	76	76	76	76
Enthalpy efficiency		%	63	67	63	65	60	62
Saved power summer mode or winter mode*		kW	1,70	4,30 (4,80)	2,50	6,50 (7,30)	3,20	8,20 (9,00)
DX coil								
Total / Sensible capacity		kW	3,00/2,10	2,50/2,70	5,10/3,50	4,40/4,80	5,80/4,10	5,20/6,70
OFF temperature		°C	15,9	28,0 (27,3)	15,5	29,6 (29,0)	16,2	28,5 (27,8)
OFF relative humidity		%	90	16 (15)	90	14 (13)	89	15 (14)

Nominal summer conditions: Outside air: 32 °C DB, RH 50%. Ambient air: 26 °C DB, RH 50%. Nominal winter conditions: Outside air: -5 °C DB, RH 80%. Ambient air: 20 °C DB, RH 50%. Cooling mode air inlet condition: 28,5 °C DB, RH 50%; evaporating temperature 7 °C. Heating mode air inlet condition: 13 °C DB, RH 40% (11 °C DB, RH 45%); condensating temperature 40 °C. DB: Dry Bulb; RH: Relative Humidity. 1) Referred to the nominal air flow after filter and plate heat exchanger. 2) Sound pressure level calculated at 1 m far from: ducted supply exhaust air ducted return - first air intake / service side, at normal condition. * Tentative data.

Accessories

CZ-RTC6W	CONEX wired remote controller (non-wireless), white
CZ-RTC6WBL	CONEX wired remote controller with Bluetooth®, white
CZ-RTC6	CONEX wired remote controller (non-wireless), black
CZ-RTC6BL	CONEX wired remote controller with Bluetooth®, black
CZ-RTC5B	Wired remote controller with Econavi function

Accessories

PAW-RE2C4-MOD-WH	Room controller for hotel rooms, white
PAW-RE2C4-MOD-BK	Room controller for hotel rooms, black
PAW-RE2D4-WH	Display control for hotel rooms, white
PAW-RE2D4-BK	Display control for hotel rooms, black

Technical focus

- Galvanized steel self-supporting panels, internally and externally insulated
- High efficiency static cross-flow heat recovery, made by membrane with high moisture permeability, good air tightness, excellent tear, and aging resistance, structure consisting of flat and corrugated plates. Total heat exchange with temperature efficiency up to 76% and enthalpy efficiency up to 67%, also at high level during summer season
- ISO16890 ePm2,5 95% (F9 EN 779) efficiency class filter with synthetic cleanable media and COARSE 50% (G3 EN 779) pre-filter ON fresh air, COARSE 50% filter on return air intake
- Removable side panel to access filters and heat recovery in the event of scheduled maintenance
- Low consumption, low noise, high efficiency direct driven fans

- Supply section complete with DX coil (R410A) fitted with solenoid control valve, freon filter, contact temperature sensors on liquid and gas line, NTC sensors upstream and downstream of air flow
- Built-in electric box equipped with PCB to control internal fan speed and to interconnect outdoor / indoor units
- Duct connection by circular plastic collars

Interconnection to outdoor / indoor units

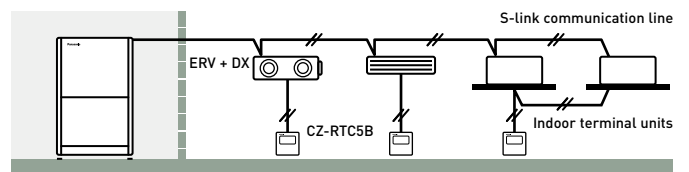

INTERNET CONTROL: Optional.

Electric air curtains

The Panasonic range of air curtains is designed for smooth operation and efficient performance. Air curtains produce a continuous stream of air blown from the top to the bottom of an open doorway and create a barrier that people and products can flow across, but air cannot.



Electric air curtain

1 Designed to maximize performance
High air flow upgraded 145% compared to conventional model (in the case of FY-3009U1).

2 Comprehensive product line up
1,5 m wide model added in the line up.

3 Easier installation and maintenance
Simple structure for easy installation and maintenance.



			FY-3009U1	FY-3012U1	FY-3015U1
Width		mm	900	1200	1500
Voltage		V	220	220	220
Air flow	Hi / Lo	m ³ /h	1100/920	1400/1270	2000/1800
Consumption	Hi / Lo	W	76/70	94/85	131/110
Current	Hi / Lo	A	0,35/0,32	0,43/0,40	0,59/0,50
Air speed	Hi / Lo	m/s	10,50/8,50	9,50/8,00	10,50/9,50
Sound pressure		dB(A)	48,5/45,0	48,5/44,5	51,5/48,0
Dimension / Net weight	HxWxD	mm / kg	900x231,5x212/12,0	1200x231,5x212/14,5	1500x231,5x212/18,0

Electric air curtain with DX coil

Designed to improve energy efficiency, minimise heat loss from a building, and allow retailers to keep doors open to encourage customers, our air curtains are suitable for connection to both VRF and PACi Systems.



Highly efficient heating effect

The combined air stream, which has a desirable low air current induction factor (mixing factor), can carry the selected initial temperature effect over long distances, and will reach the floor area while still at room temperature. This is necessary to avoid cooling down the interior spaces.

Available in different lengths to suit requirements between 1 and 2,5 m, both air curtains have outlet grilles that can be adjusted to five different positions. The HS model can be installed up to a height of 3,0 m with the LS model up to 2,7 m. The outlet grilles can be easily adjusted into five positions to suit different installation requirements and the air filter can be accessed without the need for specialist tools.

- High performance with EC fan motor (40% lower running costs compared to a standard AC fan motor)
- Easy Cleaning and Servicing
- Can be connected to either Panasonic VRF or PACi systems
- Drain pump for cooling operation included
- HS and LS models can be controlled via Panasonic's range of remote internet controls

Heating capacity comparison: Electrical air curtain / Panasonic air curtain.

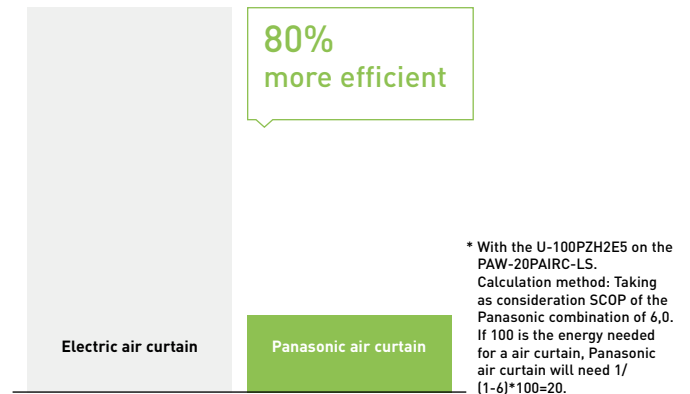

The HS and LS models are ideal for connection to a ECOi or PACi system. With simple "Plug & Play" installation, both are fitted with an EC fan motor for a smooth operation and efficient performance. This fan guarantees 40% lower running cost than with a standard AC fan motor. Air curtains run approximately 12 hours per day at shops, and efficient performance contributes to energy savings.

Optimised air flow velocity

- 1 | Energy losses, no air curtain installed
- 2 | Too low velocity air curtain – air curtain not efficient

- 3 | Too high velocity air curtain – considerable turbulence, energy lost to the outside, air curtain not efficient
- 4 | Optimum results with the Frico air curtain connected to Panasonic VRF

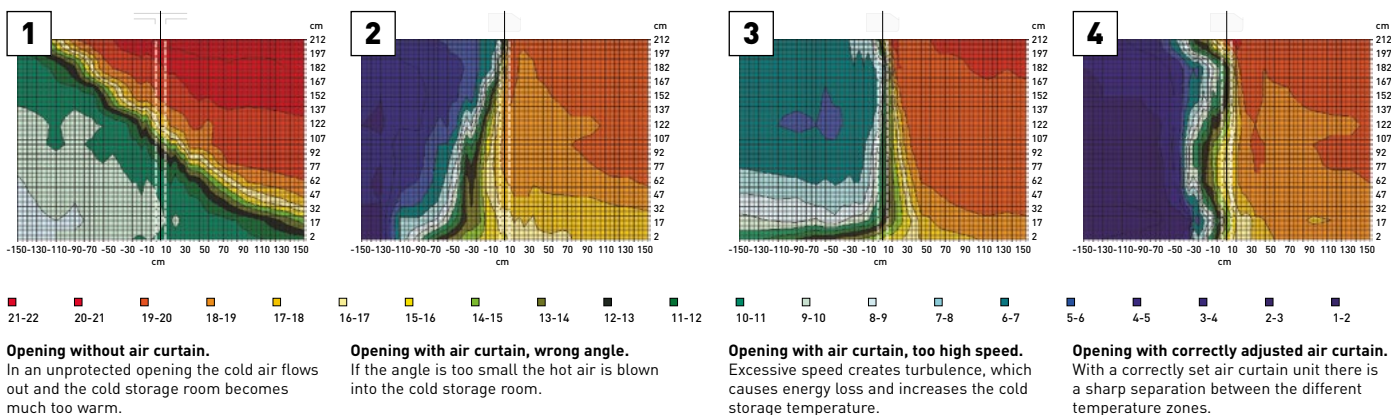

Intelligent operation

Our air curtains combine air flow and heating / cooling technology to ensure optimum comfort and energy efficiency whilst also creating an effective barrier between indoor and outdoor environments. Design and installation is key to achieving the correct height / temperature settings to achieve optimum performance. Our air curtains are designed to answer the demands of the retail, commercial and industrial markets.

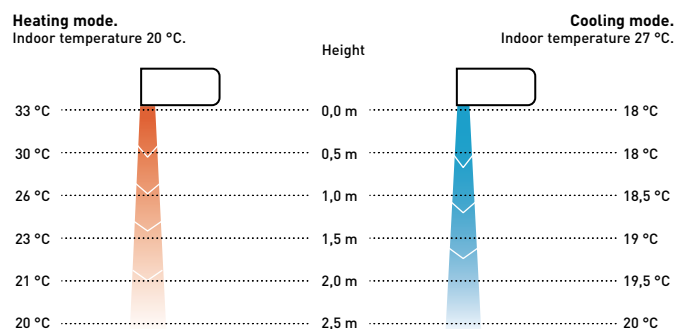

Air curtain with DX coil, connected to PACi NX and PACi

Comfort: Easy redirection of air flow by means of manual deflector.

Ease of use: Speed selector (high and low) on the unit itself.

Easy installation and maintenance: Easy installation / Compact dimensions improve installation and positioning / Easy cleaning of grid without opening of the unit.



Outdoor unit capacity			7,1 kW	10,0 kW	14,0 kW	20,0 kW
Air outlet height 2,7 m			PAW-10PAIRC-LS-1	PAW-15PAIRC-LS-1	PAW-20PAIRC-LS-1	PAW-25PAIRC-LS-1
Cooling capacity ¹⁾	Max	kW	6,1	9,7	13,0	17,0
Heating capacity ²⁾	Max	kW	7,9	12,0	15,0	19,0
Air flow	High	m ³ /h	1800	2700	3600	4500
Heat Exchanger	Volume	L	1,67	2,85	3,94	5,03
Electric consumption fan	230 V / 50 Hz	kW	0,30	0,50	0,60	0,80
Current	230 V / 50 Hz	A	2,10	3,10	4,10	5,10
Sound pressure ³⁾	Max	dB(A)	65	66	67	69
Air outlet height 3,0 m			PAW-10PAIRC-HS-1	PAW-15PAIRC-HS-1	PAW-20PAIRC-HS-1	PAW-25PAIRC-HS-1
Cooling capacity ¹⁾	Max	kW	9,1	13,0	19,5	23,7
Heating capacity ²⁾	Max	kW	11,8	15,8	23,6	27,6
Air flow	High	m ³ /h	2700	3600	5400	6300
Heat Exchanger	Volume	L	1,67	2,85	3,94	5,12
Electric consumption fan	230 V / 50 Hz	kW	0,75	1,00	1,50	1,75
Current	230 V / 50 Hz	A	4,10	5,50	8,20	9,60
Sound pressure ³⁾	Max	dB(A)	66	67	68	68
Common data						
Dimension ⁴⁾	H x W x D	mm	260 (+140) x 1000 x 460	260 (+140) x 1500 x 460	260 (+140) x 2000 x 460	260 (+140) x 2500 x 460
Net weight	Air outlet height 2,7 m	kg	50	65	80	95
	Air outlet height 3,0 m	kg	55	65	85	110
Fan type			EC	EC	EC	EC
Piping diameter	Liquid / Gas	Inch (mm)	3/8 (9,52) / 5/8 (15,88)	3/8 (9,52) / 3/4 (19,05)	3/8 (9,52) / 7/8 (22,22)	3/8 (9,52) / 7/8 (22,22)
Door width		m	1,0	1,5	2,0	2,5
Refrigerant			R32	R32	R32	R32

LS / PACi outdoor combination*	PACi Elite			PACi Standard		
	40 °C	35 °C	30 °C	40 °C	35 °C	30 °C
PAW-10PAIRC-LS-1	U-100	U-100	U-50	U-100	U-100	U-60
PAW-15PAIRC-LS-1	U-200	U-100	U-100	—	U-100	U-100
PAW-20PAIRC-LS-1	U-200	U-140	U-100	—	—	U-100
PAW-25PAIRC-LS-1	U-250	U-200	U-125	—	—	U-125

HS / PACi outdoor combination*	PACi Elite			PACi Standard		
	40 °C	35 °C	30 °C	40 °C	35 °C	30 °C
PAW-10PAIRC-HS-1	U-200	U-100	U-100	—	U-100	U-100
PAW-15PAIRC-HS-1	U-200	U-200	U-100	—	U-200	U-100
PAW-20PAIRC-HS-1	—	U-250	U-200	—	U-250	—
PAW-25PAIRC-HS-1	—	U-250	U-200	—	U-250	—

1) Cooling capacity DX coil, air temperature in / out +27 / +18 °C, R32 and R410. 2) Heating capacity condenser, air temperature in / out +20 / +33 °C, R32 and R410. In the case of lower outdoor temperatures, an outdoor model with higher capacity may be necessary. 3) Measured in distance up to 5,0 m, direction factor 2, absorbing surfaces 200 m², Min / Max air flow. 4) 140 mm is the height of an electrical box if it is installed on the top. * Available with PZH2 and PZ2. PZH3 and PZ3 will be compatible from Autumn 2023.

Technical focus

- Now compatible with PACi NX Series
- Save up to 40% energy costs by use of the integrated EC fan technology (higher efficiency than conventional AC fan, soft start and longer motor duration)
- 4 length of air curtain LS and HS are available 1,0, 1,5, 2,0 and 2,5 m
- Installation height up to 3,0 m
- Outlet grilles can be adjusted in five positions, to suite different indoor and installation requirements
- Control with Panasonic remote control systems (optional)
- Direct integration to BMS via optional Panasonic interfaces
- Drip tray included in all DX air curtains
- Drain pump included

How does it work?

Stale air from the room is taken in and ejected near the door. This creates a 'roll of air' that shields the door area, mixing with the colder incoming air. It then turns away from the door, back into the room and toward the intake screen, where it is partly drawn in again. This flow of air helps to create a barrier for heat loss yet at the same time refreshes room air

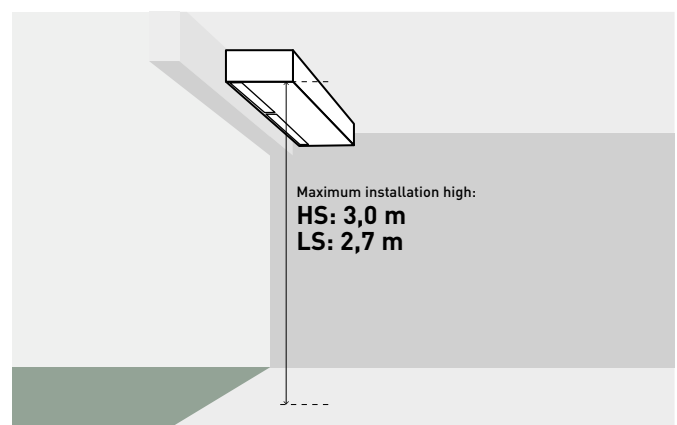

Air curtain with DX coil, connected to VRF systems

Comfort: Easy redirection of air flow by means of manual deflector.

Ease of use: Speed selector (high and low) on the unit itself.

Easy installation and maintenance: Easy installation / Compact dimensions improve installation and positioning / Easy cleaning of grid without opening of the unit.



Outdoor unit capacity			4 HP		5 HP		8 HP	
Air outlet height 2,7 m			PAW-10EAIRC-LS	PAW-15EAIRC-LS	PAW-20EAIRC-LS	PAW-25EAIRC-LS		
Cooling capacity ¹⁾	Max	kW	6,1	9,7	13,0	17,0		
Heating capacity ²⁾	Max	kW	7,9	12,0	15,0	19,0		
Air flow	High	m ³ /h	1800	2700	3600	4500		
Heat Exchanger	Volume	L	1,67	2,85	3,94	5,03		
Electric consumption fan	230 V / 50 Hz	kW	0,30	0,50	0,60	0,80		
Current	230 V / 50 Hz	A	2,10	3,10	4,10	5,10		
Sound pressure ³⁾	Max	dB(A)	65	66	67	69		
Air outlet height 3,0 m			PAW-10EAIRC-HS	PAW-15EAIRC-HS	PAW-20EAIRC-HS	PAW-25EAIRC-HS		
Cooling capacity ¹⁾	Max	kW	9,1	13,0	19,5	23,7		
Heating capacity ²⁾	Max	kW	11,8	15,8	23,6	27,6		
Air flow	High	m ³ /h	2700	3600	5400	6300		
Heat Exchanger	Volume	L	1,67	2,85	3,94	5,12		
Electric consumption fan	230 V / 50 Hz	kW	0,75	1,00	1,50	1,75		
Current	230 V / 50 Hz	A	4,10	5,50	8,20	9,60		
Sound pressure ³⁾	Max	dB(A)	66	67	68	68		
Common data								
Dimension ⁴⁾	H x W x D	mm	260 (+140) x 1000 x 460	260 (+140) x 1500 x 460	260 (+140) x 2000 x 460	260 (+140) x 2500 x 460		
Net weight	Air outlet height 2,7 m	kg	50	65	80	95		
	Air outlet height 3,0 m	kg	55	65	85	110		
Fan type			EC	EC	EC	EC		
Piping diameter	Liquid / Gas	Inch (mm)	3/8(9,52) / 5/8(15,88)	3/8(9,52) / 3/4(19,05)	3/8(9,52) / 7/8(22,22)	3/8(9,52) / 7/8(22,22)		
Door width		m	1,0	1,5	2,0	2,5		
Refrigerant			R32 / R410A	R32 / R410A	R32 / R410A	R32 / R410A		

LS / VRF outdoor combination			
Operation until	40 °C	35 °C	30 °C
PAW-1EAIRC-LS	U-4	U-4	U-4
PAW-15EAIRC-LS	U-6	U-5	U-4
PAW-20EAIRC-LS	U-8	U-6	U-4
PAW-25EAIRC-LS	U-8	U-8	U-5

HS / VRF outdoor combination			
Operation until	40 °C	35 °C	30 °C
PAW-10EAIRC-HS	U-6	U-5	U-4
PAW-15EAIRC-HS	U-8	U-6	U-4
PAW-20EAIRC-HS	U-8	U-8	U-8
PAW-25EAIRC-HS	U-12	U-10	U-8

1) Cooling capacity DX coil, air temperature in / out +27 / +18 °C, R32 and R410. 2) Heating capacity condenser, air temperature in / out +20 / +33 °C, R32 and R410. In the case of lower outdoor temperatures, an outdoor model with higher capacity may be necessary. 3) Measured in distance up to 5,0 m, direction factor 2, absorbing surfaces 200 m², Min / Max air flow. 4) 140 mm is the height of an electrical box if it is installed on the top. * Also compatible with ECO G Series (GE3 and GF3) and Hybrid Serie.

Technical focus

- Compatible with R32 and R410A refrigerant
- Save up to 40% energy costs by use of the integrated EC fan technology (higher efficiency than conventional AC fan, soft start and longer motor duration)
- 4 length of air curtain LS and HS are available 1,0, 1,5, 2,0 and 2,5 m
- Installation height up to 3,0 m
- Outlet grilles can be adjusted in five positions, to suite different indoor and installation requirements
- Control with Panasonic remote control systems (optional)
- Direct integration to BMS via optional Panasonic interfaces
- Drip tray included in all DX air curtains
- Drain pump included

Internet control

An app added to your tablet or smartphone or via the Internet allows you to control and manage the system remotely. There is also the option to integrate into existing BMS systems by using other Panasonic interfaces.

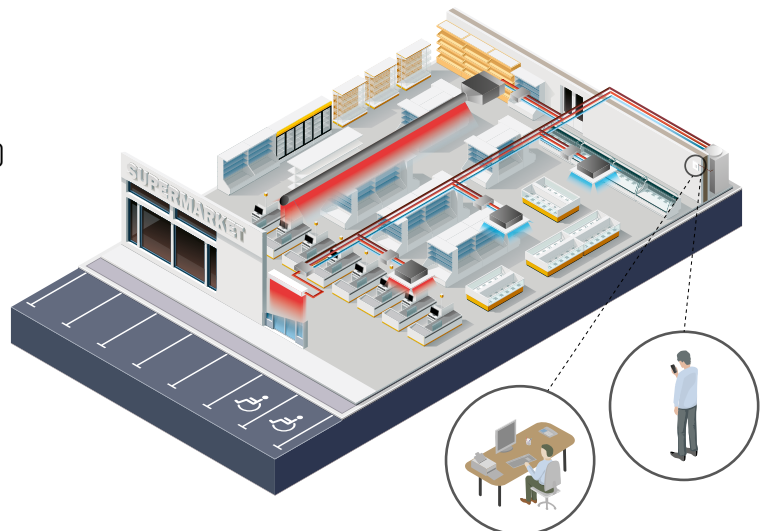

High pressure duct and 100% fresh air duct function for all ECOi and ECO G systems

The E2 range of ducted units offers improved design flexibility for extended duct layouts as a result of their increased external static pressures whilst reducing energy consumption, while providing fresh air to larger spaces.



E2 type high static pressure hide-away · R410A
High pressure duct and 100% fresh air duct function.



+ COMPATIBLE WITH ALL PANASONIC CONNECTIVITY SOLUTIONS. FOR DETAILED INFORMATION GO TO THE CONTROL SYSTEMS SECTION

Type	100% Fresh air duct function (by using Kit for 100% fresh air)				High pressure duct					
	S-224ME2E5		S-280ME2E5		S-224ME2E5		S-280ME2E5			
Indoor unit		Cooling	Heating	Cooling	Heating	Cooling	Heating	Cooling	Heating	
Capacity	kW	22,4	21,2	28,0	26,5	22,4	25,0	28,0	31,5	
Input power	W	290,00	290,00	350,00	350,00	440,00	440,00	715,00	715,00	
Current	A	1,85	1,85	2,20	2,20	2,45	2,45	3,95	3,95	
Air flow	Hi/Med/Lo	m ³ /min 28,3/-/-		35,0/-/-		56,0/51,0/44,0		72,0/63,0/53,0		
External static pressure	Pa	200		200		140(60-270) ¹⁾		140(72-270) ¹⁾		
Sound pressure ²⁾	Hi/Med/Lo	dB(A) 43/-/-		44/-/-		45/43/41		49/47/43		
Sound power	Hi/Med/Lo	dB(A) 75/-/-		76/-/-		77/75/73		81/79/75		
Dimension	H x W x D	mm 479 x 1453 x 1205		479 x 1453 x 1205		479 x 1453 x 1205		479 x 1453 x 1205		
Net weight	kg	102		106		102		106		
Piping diameter	Liquid	Inch (mm)	3/8(9,52)		3/8(9,52)		3/8(9,52)		3/8(9,52)	
	Gas	Inch (mm)	3/4(19,05)		7/8(22,22)		3/4(19,05)		7/8(22,22)	

Rating Conditions for 100% Fresh air duct function: Cooling Outdoor 33 °C DB / 28 °C WB. Heating Outdoor 0 °C DB / -2,9 °C WB.
 1) Available to select the setting by initial setup. 2) Values with 140 Pa setting. * No filter included. ** No compatible with 3-Pipe ECO G GF3.

Accessories	
CZ-RTC6W	CONEX wired remote controller (non-wireless), white
CZ-RTC6WBL	CONEX wired remote controller with Bluetooth®, white
CZ-RTC6	CONEX wired remote controller (non-wireless), black
CZ-RTC6BL	CONEX wired remote controller with Bluetooth®, black
CZ-RTC5B	Wired remote controller with Econavi function
CZ-RWS3 + CZ-RWRC3	Infrared remote controller and receiver

Accessories	
PAW-RE2C4-MOD-WH	Room controller for hotel rooms, white
PAW-RE2C4-MOD-BK	Room controller for hotel rooms, black
PAW-RE2D4-WH	Display control for hotel rooms, white
PAW-RE2D4-BK	Display control for hotel rooms, black
CZ-CENSC1	Econavi energy saving sensor

Technical focus

- No need of rap valves for standard operation
- 100% fresh air duct function*
- DC fan motor for more savings
- Complete flexibility for ductwork design
- Can be located within a weatherproof housing for external installation
- Air OFF sensor avoids cold air dumping
- Configurable air temperature control

* Rap valves required, see 100% fresh air duct function below.

100% fresh air duct function

The E2 duct with 100% fresh air duct function have exceptional discharge temperature.

	Discharge Range		
	Min	Max	Default
Cooling	15 °C	24 °C	18 °C
Heating	17 °C	45 °C	40 °C

System example

An inspection port (450 x 450 mm or more) is required at the lower side of the indoor unit body (field supply).

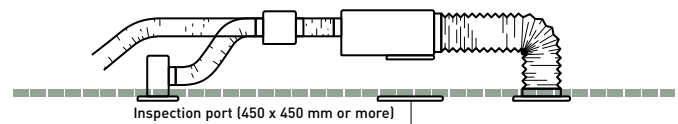

Plenums

Air outlet plenum (suitable for rigid + flexible duct)		
	Number of exits with diameters	Model
S-224ME2E5	1 x 500 mm	CZ-TREMIESPW705
S-280ME2E5	1 x 500 mm	CZ-TREMIESPW706

Kit for 100% fresh air function

Kit for 2 way systems		Kit for 3 way systems	
2x CZ-P160RVK2	Rap valve kit	2x CZ-P160HR3	3 way valve kit
2x CZ-CAPE2	3 way control PCB	2x CZ-CAPE2	3 way control PCB
CZ-P680BK2BM	Distribution joint kit	CZ-P680BH2BM	Distribution joint kit
	1x remote controller		1x remote controller



ECONAVI and INTERNET CONTROL: Optional.

Ceiling mounted air-e nanoe X Generator

Bringing nature's balance indoors with Panasonic's unique nanoe™ X technology built into the air-e.

Deodorises and inhibits certain bacteria, viruses, mould, pollens and allergens for better indoor air quality.



The air-e is a stand alone device which is an easy and simple choice to improve indoor air quality. It can be easily installed to various commercial projects including refurbishments.

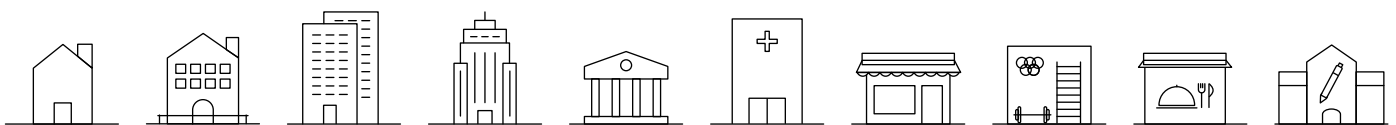

The tested effects of nanoe™ X

Bacteria and viruses.

SARS-CoV-2: 99,9% % inhibited ¹⁾.

Influenza virus H1N1 subtype: 99,9 % inhibited ²⁾.

Odour.

nanoe X Generator can reduce cigarette smoke odour intensity by 2,4 levels in 12 minutes.

1) Novel coronavirus [SARS-CoV-2] > [Test organization] Texcell (France) [Test subject] Adhered novel coronavirus [SARS-CoV-2] [Test volume] 45 L enclosed box [Test result] Inhibited 99,9% in 2 hours [Test report] 1140-01 A1.

2) Adhered virus (Influenza virus H1N1 subtype) > [Test organization] Kitasato Research Center for Environmental Science [Test subject] Influenza virus (H1N1 subtype) [Test volume] 1000 L enclosed box [Test result] Inhibited 99,9% in 2 hours [Test report] 21_0084_1.

3) Deodorisation effect for adhering odour (cigarette smoke) > [Test organization] Panasonic Product Analysis Center [Test subject] Adhered cigarette smoke odour [Test volume] Approx. 24 m³ laboratory [Test result] Odour intensity reduced 2,4 levels in 0,2 hours [Test report] 4AA33-160615-N04.

Performance of nanoe™ X might differ in real life environment and is only expected in the same room as where the unit is placed. The nanoe™ X performance varies depending on the room size, environment and usage and it may take several hours to reach the full effect. nanoe™ X is not a medical device.

Deodorisation effect for adhering odour (cigarette smoke) ³⁾.

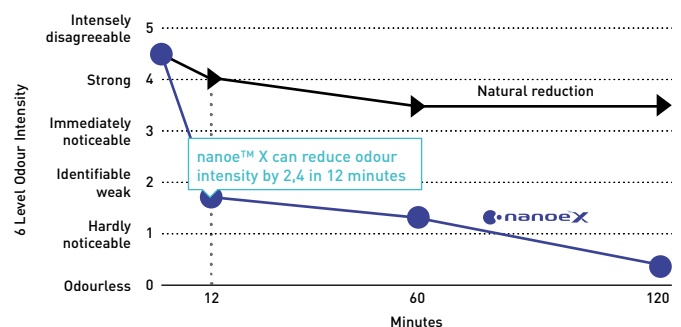

For further details and validation data, please refer to the following website.



Ceiling mounted air-e nanoe X Generator

- nanoe™ X technology
(Generator Mark 1= 4,8 trillion hydroxyl radicals/sec)
- Silent operation. Whisper quiet at 25,5 dB(A)*
- Low power consumption 4 W
- Easy Installation
- Compact and modern design

* 230 V.

air-e™



Model	FV-15CSD1G				
Power supply	Voltage	V	220	230	240
	Frequency	Hz	50	50	50
Air flow		m³/h	15	16	17
		CFM	8,8	9,4	10,0
Consumption		W	4	4	4
Sound pressure		dB(A)	23,5	25,5	27,0
Net weight		kg		1,1	

* The value of air volume, power consumption and noise are specified at static pressure 0 Pa. The value of air volume is the mean value and a tolerance of +-10% is allowed. The value of noise level is a weighted average sound pressure level, the mean value is measured by Panasonic. A tolerance of +3 dB/-7 dB is allowed. The noise is measure at 1 m apart from the left, the front and below of the tested product. Conditions of generating nanoe™ X: room temperature: about 5 °C - 40 °C (dew point temperature more than 2 °C), relative humidity: about 30% - 85%. nanoe™ X is generated using the air in the room, and its amount is subject to the temperature and humidity in the air.

One device is suitable for around 20 m² (with a ceiling height 3 m)

Ex. 3 air-e devices are required for the room size 60 m².

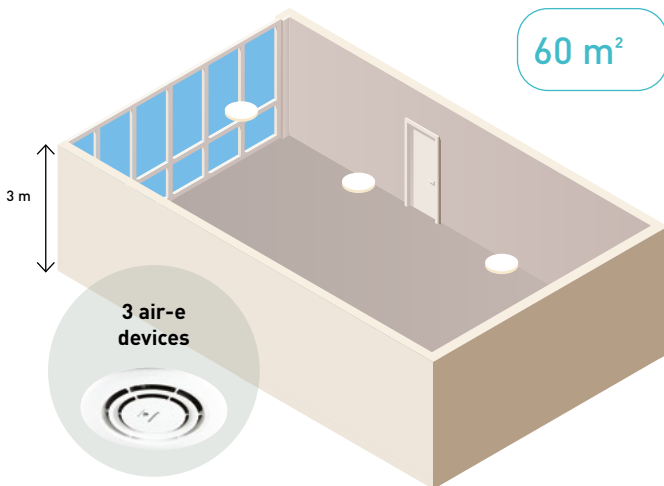

Concentration simulator is ready

See how nanoe™ X fills space.

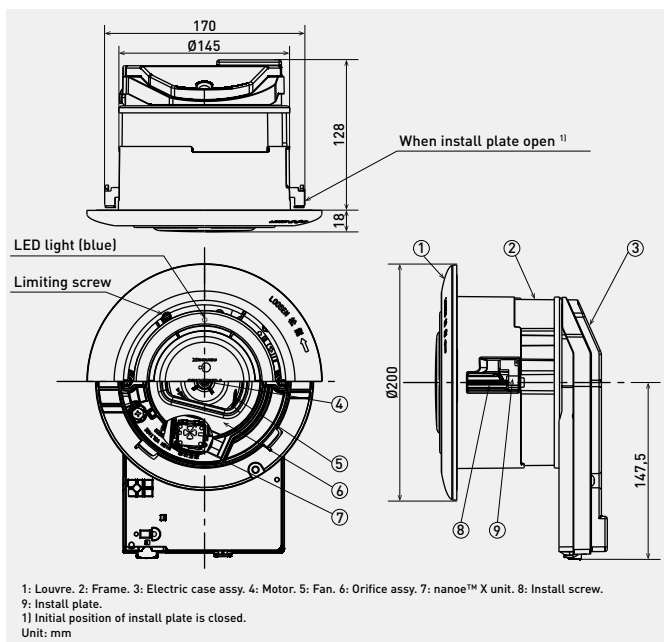

Projects with nanoe™ X.



Cabinet Dental. France.
The request by a customer to manage the indoor air quality in order to ensure irreproachable hygiene and odour control.

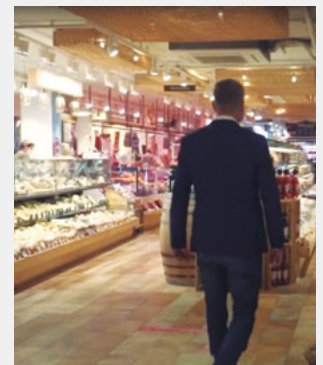

Mercat d'autors shop. Spain.
The nanoe™ X was chosen to ensure a cleaner air supply at a food market.

Heat recovery ventilation unit

The heat recovery ventilation unit is design not only to provide a good indoor air quality, but it is also designed to recover heat that would otherwise be lost throughout ventilation. These heat recovery ventilation systems are used to assist in the retention of heat.

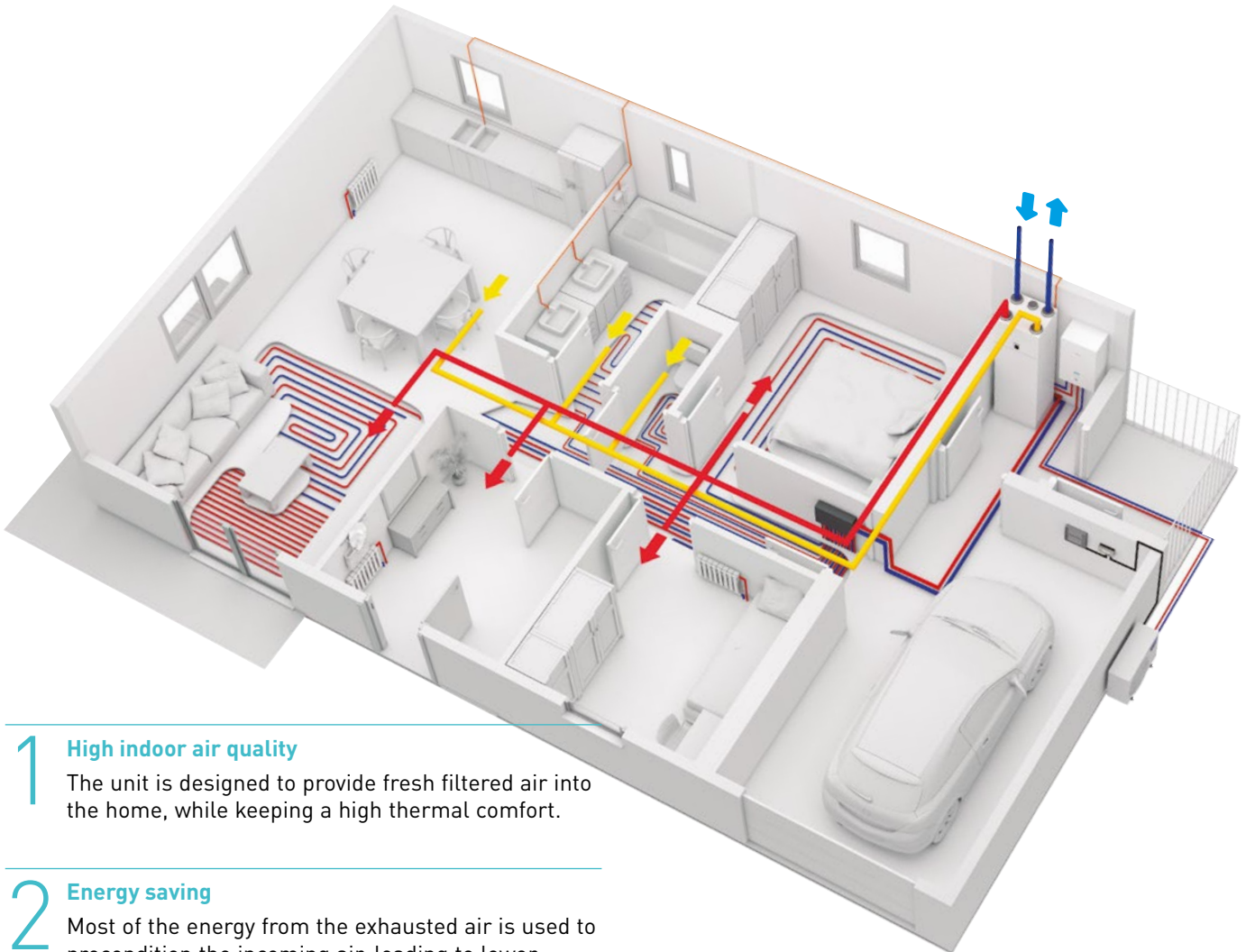

1 High indoor air quality
The unit is designed to provide fresh filtered air into the home, while keeping a high thermal comfort.

2 Energy saving
Most of the energy from the exhausted air is used to precondition the incoming air, leading to lower heating requirements in the building.

3 Space saving
The compact ventilation unit can be installed over the DHW square tank or the Aquarea All in One Compact indoor unit for a space-saving solution.

4 Better user interface
The Residential ventilation unit and the Aquarea Heat Pump can be controlled with one single user-friendly controller.

AQUAREA

Combine the Residential ventilation unit with Panasonic Aquarea for a space saving and highly efficient solution for heating, cooling, ventilation and DHW.



Heat Recovery Ventilation +
Aquarea All in One Compact



Heat Recovery Ventilation +
DHW Square Tank + Aquarea
Mono-bloc



Heat Recovery Ventilation +
DHW Square Tank + Aquarea
Bi-bloc

* The unit can be mounted on a PAW-TA20C1E5C, on a WH-ADC0309J3E5C or installed on the wall (PAW-VEN-WBRK is needed).



PAW-A2W-VENTA-R

PAW-A2W-VENTA-L



Heat recovery ventilation unit		PAW-A2W-VENTA-R	PAW-A2W-VENTA-L
Nominal air flow rate	m ³ /h	204 @ 50 Pa	
Maximum air flow rate	m ³ /h	292 @ 100 Pa	
SPF		1,24 @ 204 m ³ /h	
Heat exchanger rotor drive type		Variable speed	
Exchanger type		Rotating	
Heat recovery efficiency		84%	
Power supply	V / Hz	230 / 50 / 1 phase	
Power consumption	W	176	
Energy class, basic unit		A	
Energy class, unit with local control on demand		A	
Noise level	dB(A)	40	
Dimension (H x W x D)	mm	450 x 598 x 500	
Weight	kg	46	
Mounting position		Vertical	
Supply side		Right	Left
Duct connections	mm	DN125	
Filter class, supply air		F7/ePM1 60%	
Filter class, extract air		M5/ePM10 50%	
Minimum outdoor temperature	°C	-20	

* Heat recovery efficiency according to EN 13141-7. ** Heat recovery ventilation unit is produced by Systemair.

Accessories	
PAW-VEN-FLTKIT	Supply and extract filters kit
PAW-VEN-ACCPCB	Optional PCB for additional functions
PAW-VEN-DPL	HRV touch control panel. White frame (cable must be ordered separately)
PAW-VEN-CBLEXT12	Cable with plug for electrical connection between unit and control panel, type CE and CD (12 m)
PAW-VEN-DIVPLG	Twin plugs for installation of several control panels type CD or CE for one unit

Accessories	
PAW-VEN-DPLBOX	HRV touch control panel wall-mounted kit
PAW-VEN-S-CO2RH-W	CO ₂ RH wall-mounted sensor
PAW-VEN-S-CO2-W	CO ₂ wall-mounted sensor
PAW-VEN-S-CO2-D	CO ₂ duct sensor
PAW-VEN-WBRK	Wall bracket kit for stand-alone installation on the wall
PAW-VEN-HTR06	Electrical duct heater 0,6 kW (includes relay)
PAW-VEN-HTR12	Electrical duct heater 1,2 kW (includes relay)

Main features of the residential ventilation unit

- Designed for areas up to approximately 140 m²
- High energy-efficiency rotary heat exchanger with EC - technology fans
- Moisture transfer function to minimize condensation in supply air during wintertime
- The built in humidity sensor in extract air can be used for demand control
- Control via touch display and Startup Wizard for easy commissioning
- Modbus communication via RS-485
- Option to control an Aquarea H Generation onwards heat pump from PAW-A2W-VENTA control panel (PAW-AW-MBS-H and PAW-VEN-ACCPCB required)

Control user-friendly interface

All settings and features accessible via a control panel, integrated into the front cover. The option for connecting one or more external control panels is available.

- Color touch screen with a user-friendly interface
- MANUAL and AUTO mode or choose preferred settings from the pre-configured user modes

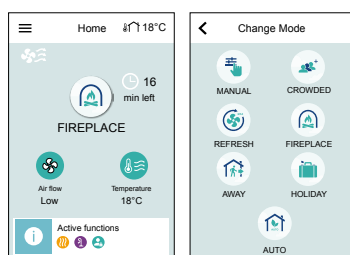

- If Aquarea H and J Generations heat pumps are connected with PAW-A2W-VENTA, the heat pump control options appear on the home screen in a separate tab

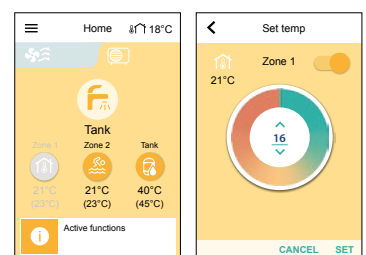

New counter flow ventilation

Controlled mechanical ventilation ensures the supply of fresh air inside a building in order to guarantee a good indoor air quality.



Universal mounting compact unit (Z).

- Suitable for small and medium size apartments, with nominal air flow up to 200 m³/h
- Universal mounting (horizontal or vertical)



Horizontal mounting unit (H).

- Suitable for single family houses, with nominal air flow rates up to 350 m³/h
- Horizontal mounting
- Easily accessible lower panel for maintenance and inspection



Vertical mounting unit (V).

- Suitable for single family houses, with nominal air flow rates up to 350 m³/h
- Vertical mounting
- Easily accessible front panel for maintenance and inspection





Counter flow ventilation	PAW-	VENTX10Z	VENTX15Z	VENTX20H	VENTX20V	VENTX30H	VENTX30V	VENTX40H	VENTX40V	
Air flow	Nominal / Max	m³/h	91/130	147/210	109/155	112/170	210/300	210/300	238/340	266/380
Static pressure	Nominal / Max	Pa	50/100	50/100	50/100	50/100	50/100	50/100	50/100	50/100
Type of HEX		Counter flow HRV	Counter flow HRV	Counter flow HRV	Counter flow HRV	Counter flow HRV	Counter flow HRV	Counter flow HRV	Counter flow HRV	
Recovery efficiency	%	87	85	86	86	85	86	89	87	
Energy class		A	A	A	A	A	A	A	A	
Power supply	Voltage	V	230	230	230	230	230	230	230	
	Phase		Single phase	Single phase	Single phase	Single phase	Single phase	Single phase	Single phase	
Power consumption	Frequency	Hz	50	50	50	50	50	50	50	
	Nominal	W	80	140	110	110	180	180	350	350
Sound Power LWA		dB(A)	48	51	49	48	50	50	52	51
Dimensions	HxWxD	mm	255x580x580	255x580x580	260x480x800	510x430x625	295x600x795	590x575x785	290x650x1150	590x735x785
Weight		kg	19	19	25	32	30	38	38	42
Mounting position			Horizontal / Vertical	Horizontal / Vertical	Horizontal	Vertical	Horizontal	Vertical	Horizontal	Vertical
Filter class			ePM1 80%	ePM1 80%	ePM1 80%	ePM1 80%	ePM1 70%	ePM1 70%	ePM1 70%	ePM1 70%
Duct connection		mm	160	160	160	160	160	160	160	160

* Produced by Sinergia.

Accessories	
PAW-VEN-CTRLB	Digital remote control (black). Integrated air quality, temperature and humidity sensors
PAW-VEN-CTRLW	Digital remote control (white). Integrated air quality, temperature and humidity sensors
PAW-VEN-HTR05	Electrical duct heater 0,5 kW, DN125 mm
PAW-VEN-HTR10	Electrical duct heater 1,0 kW, DN160 mm
PAW-VEN-FLT1	Spare F7 filter kit (2 pcs) for models 10Z, 15Z, 20H and 20V
PAW-VEN-FLT2	Spare F7 filter kit (2 pcs) for models 30H and 30V

Accessories	
PAW-VEN-FLT3	Spare F7 filter kit (2 pcs) for models 40H
PAW-VEN-FLT4	Spare F7 filter kit (2 pcs) for models 40V
PAW-VEN-ACFLT1	Activated carbon filter (1 pc) for models 10Z, 15Z, 20H and 20V
PAW-VEN-ACFLT2	Activated carbon filter (1 pc) for models 30H and 30V
PAW-VEN-ACFLT3	Activated carbon filter (1 pc) for models 40H
PAW-VEN-ACFLT4	Activated carbon filter (1 pc) for models 40V

Counter flow ventilation units are equipped with two fans to supply and extract air. A cross-flow heat exchanger recovers the energy contained in the extracted air and transfers it to the supplied air. This significantly reduces the building's energy consumption, while at the same time keeping a good quality of the indoor air.

Balanced ventilation

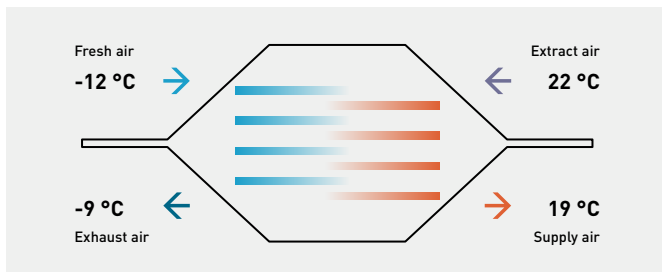

- Suitable for single family houses or apartments with low energy requirements
- High-efficiency sensible heat recovery, thanks to polypropylene counter-flow heat exchanger with large exchange surface and low pressure drop
- High comfort and quiet operation, by using brushless fans with electronic motor and modulating control
- Highly efficient air renewal and filtration, with 80% ePM1 filters
- 3 unit types: compact universal mounting (Z), horizontal mounting (H) and vertical mounting (V)
- Compact dimensions for simplified installation and panel easily accessible for maintenance and inspection



Control and connectivity

Panasonic has developed a wide range of control systems to offer the best options for commercial and residential needs, from the individual remote controllers, to the newest technology capable of controlling your building anywhere in the world. The simple to use cloud software can even be used from a portable device.

Control and connectivity map for Panasonic business area	→ 366	Individual wireless controllers	→ 402
VRF Smart Connectivity+	→ 368	Infrared remote controller	→ 402
Smart multi-site control solution	→ 372	Remote sensor	→ 402
Panasonic AC Smart Cloud	→ 374		
Panasonic AC Service Cloud	→ 376	Centralised controllers	→ 403
Panasonic AC Smart Cloud packages	→ 378	System controller with schedule timer	→ 403
Commercial Wi-Fi Adaptor	→ 380	ON / OFF controller	→ 403
CONEX. Devices and apps	→ 382	Intelligent controller (touch screen panel)	→ 404
Remote controller with Econavi	→ 386	P-AIMS core software	→ 405
Datanavi	→ 388	Local adaptor for ON / OFF control	→ 406
Intelligent controller	→ 390	Demand control for Mini ECOi and PACi outdoor units	→ 406
Econavi Sensor	→ 392	Mini Seri-Para I/O Unit 0 -10 V	→ 407
Controller for hotel application	→ 394	Communication adaptor for VRF connectivity	→ 407
BMS interface with S-Link	→ 396		
Control and connectivity	→ 398	PACi and VRF connectivity	→ 408
Individual controllers wired	→ 400	ECOi, ECO G and PACi connectivity indoor units	→ 410
CONEX wired remote controller	→ 400	T10 connector (CN061)	→ 410
Room controller for hotel rooms	→ 400	Fan drive connector (CN032)	→ 411
Display control for hotel rooms	→ 401	Option connector (CN060) output external signals	→ 411
Design wired remote controller	→ 401	EXCT connector (CN009)	→ 411

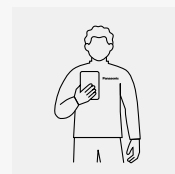
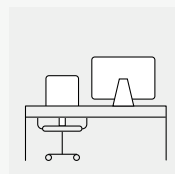
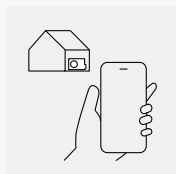
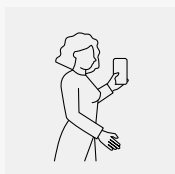
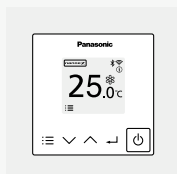

Control and connectivity map for Panasonic business areas

A wide range of control and connectivity solutions to suit a variety of applications. Integration capability, scalable solutions and smart connectivity offer a unique portfolio to meet every customer's needs.

Integration with Home Automation or KNX.

Simple and flexible solution to integrate Panasonic heating and cooling systems into smart home energy solutions.

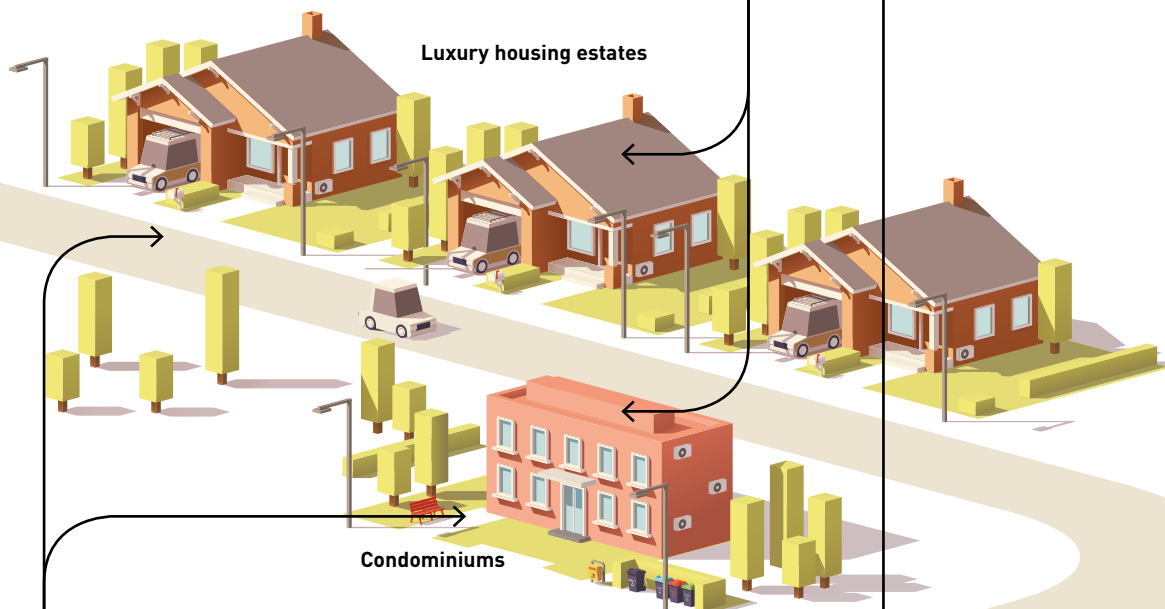

New 2023

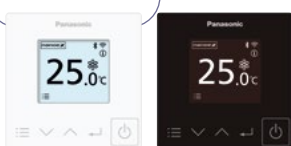

CONEX.

Simple and intuitive control with smart apps availability ¹⁾. Each of the specialized apps, for owners or HVAC&R professionals, support daily operation. Allows connection of one, or a group of indoor units, to Panasonic Comfort Cloud App, which provides control, monitoring, scheduling and error alerts. Compatible with Voice Control ²⁾.

+ REFER TO PAGE 382 FOR MORE DETAILS

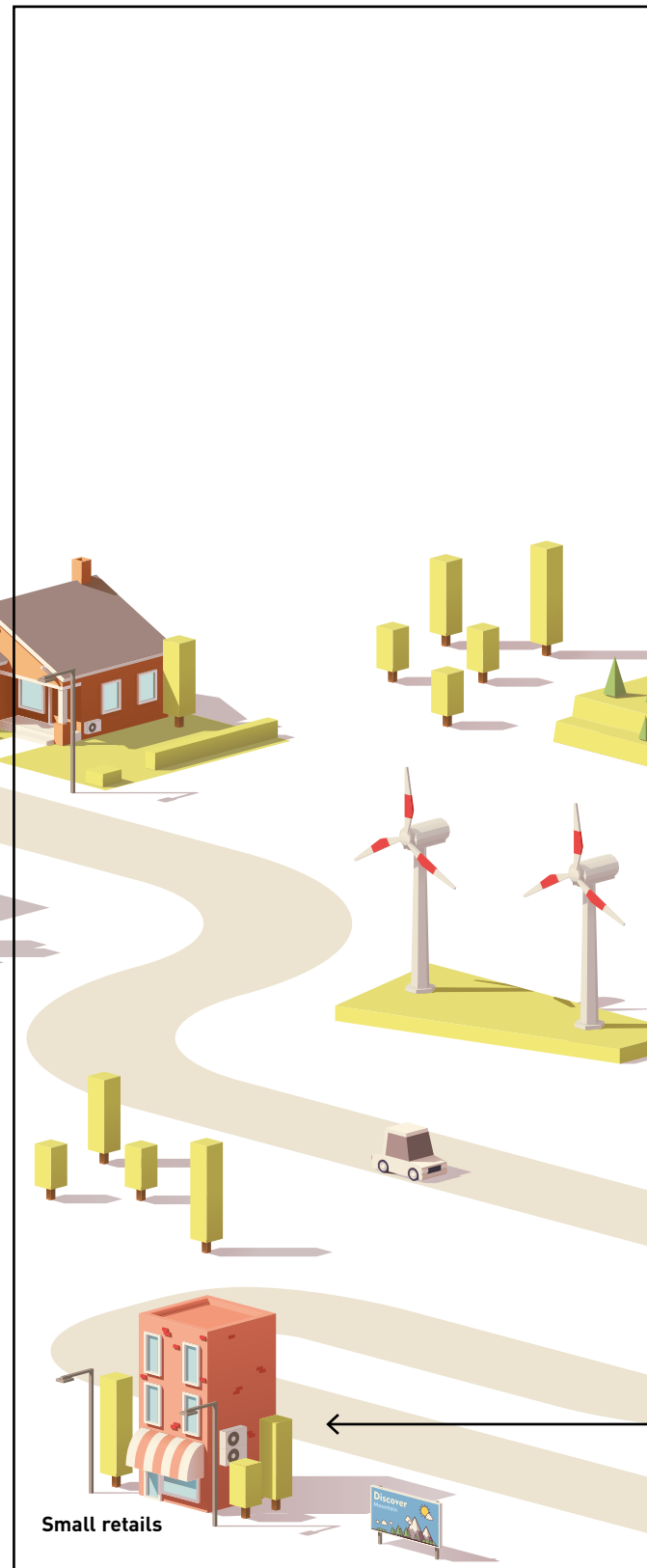

1) App connectivity available with CZ-RTC6WBL, CZ-RTC6BL, CZ-RTC6WBLW and CZ-RTC6BLW.
 2) Alexa, Google Home.... Giving indication of compatible options.
 3) Panasonic AC Smart Cloud connection required to access Panasonic AC Service Cloud.
 4) 2 DI on standard version and 4 DI/DO available on Modbus version.
 5) 128 indoor units as standard, additional communication adaptor required for 256 units.



Panasonic AC Smart / Service Cloud.

Smart multi-site solution provides users with complete scalable control for all business installations, 24/7, from any connected location.

Panasonic AC Smart Cloud for business owners and Panasonic AC Service Cloud ³⁾ for HVAC service/maintenance companies.

+ REFER TO PAGE 374 FOR MORE DETAILS

Hotels

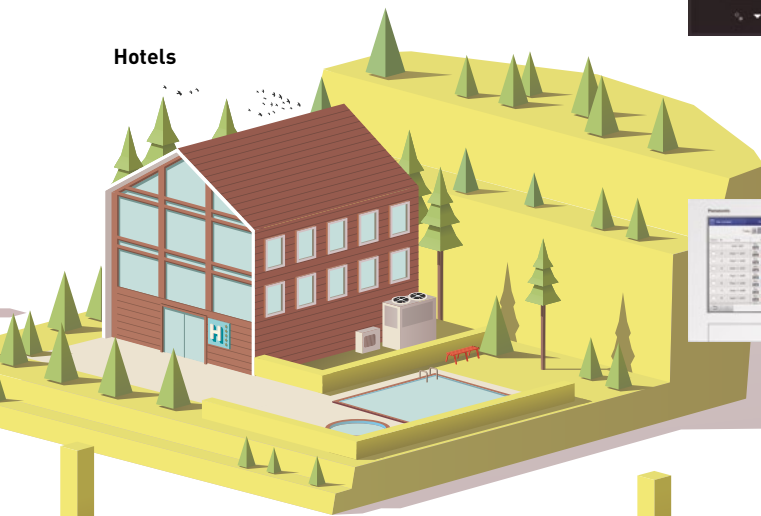

VRF Smart Connectivity+.

Control the air quality of guest rooms utilising CO₂ and humidity sensors. Easy BMS integration for entire building management.

+ REFER TO PAGE 368 FOR MORE DETAILS

Controller for hotel application.

Intuitive controller allowing up to 4 digital inputs and outputs ⁴⁾. Perform the most common operations in hotel rooms, such as key cards and window contacts.

+ REFER TO PAGE 394 FOR MORE DETAILS

Intelligent controller.

Centralized controller with large LCD touch screen display. Maximum 256 ⁵⁾ indoor units connectable, ideal for larger buildings.

+ REFER TO PAGE 390 FOR MORE DETAILS

Offices / Large buildings

Supermarkets

Integration with BACnet or Modbus.

Easy and reliable solution to integrate Panasonic heating and cooling systems into the building management systems in your business.

VRF Smart Connectivity+

Through thorough energy management, Panasonic's VRF Smart Connectivity+ is a state-of-the-art solution providing energy saving and comfort as well as simple installation, operation and running.



VRF Smart Connectivity+ solution offers efficient energy management, high IAQ (indoor air quality), and air conditioning control.

Panasonic **Schneider**
Electric



Dramatic reduction of OpEx with outstanding IAQ.

3 built-in sensors:
Temperature, RH and occupancy.
ZigBee wireless sensors:
CO₂ / temperature / RH%,
window / door,
ceiling / wall / water
leakage.
Relay Pack, Hotel room
controller.



Ultimate customisation.

Customisable colour
background.
Custom display/icons,
messages.
Programmable logic (also
stand alone).
Various controls and
various external connection
devices.



User-/owner-friendly.

Colour touch screen.
Simple and easy to use.
22 languages.
Easy-to-understand error
description.

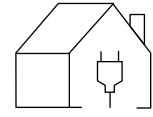

Easy design and Plug & Play to reduce CapEx.

Simple Plug & Play VRF
connection to Building
Energy Management
System (BEMS).
Stand alone or BEMS
connected.
Easy installation of ZigBee
sensors.

Energy management system for rooms.

Each room is monitored by precision sensors, making it possible to provide high comfort levels without wasting energy.



Management system for the entire building.

A Building Energy Management System (BEMS) can also be connected with Plug & Play centralised control of the entire building's energy consumption.

VRF Smart Connectivity+
SER8150.

1 Air quality control

Optimum IAQ is realized using the CO₂ and humidity sensors. The interior environment remains comfortable, while heating and cooling costs are minimized.
The CO₂ sensor can control ventilation systems, which contribute to improving the room's air quality.

2 Easy installation and integration

A single device is all that's required for occupancy and optimum automatic indoor air quality (IAQ) control. Simple operation with an interface that it is not an owned device contributes to increased energy efficiency and productivity for reduced capital expenditure (CapEx) and operating expense (OpEx).

3 Other equipment control

One room controller manages various devices including lighting and the blinds.
Control ventilation systems and other external connection devices with this BEMS.



Door/window sensor.

Door and window contact detection sensor to monitor opening and closing.



Wall/ceiling motion/temperature/humidity sensor.

Wall and ceiling sensor to detect the presence or absence of occupants.



CO₂/temperature/humidity sensor.

Monitor indoor air quality, review data on interfacing devices, and control fresh air inside customisable zones.



Water leakage sensor.

Two sensing pads under the body activate when water is present between the two pads. Detecting the water, the sensor reports the event to the controller (and BEMS).



Hotel room controller (HRC).

The Hotel room controller controls connected guest room devices and aggregates data, making it visible to guest room and property management systems.

VRF Smart Connectivity+

Energy management system for rooms.

By installing a wall/ceiling motion temperature sensor, window/door sensor, and CO₂ sensor in the room, ideal, waste-free air conditioning is achieved.

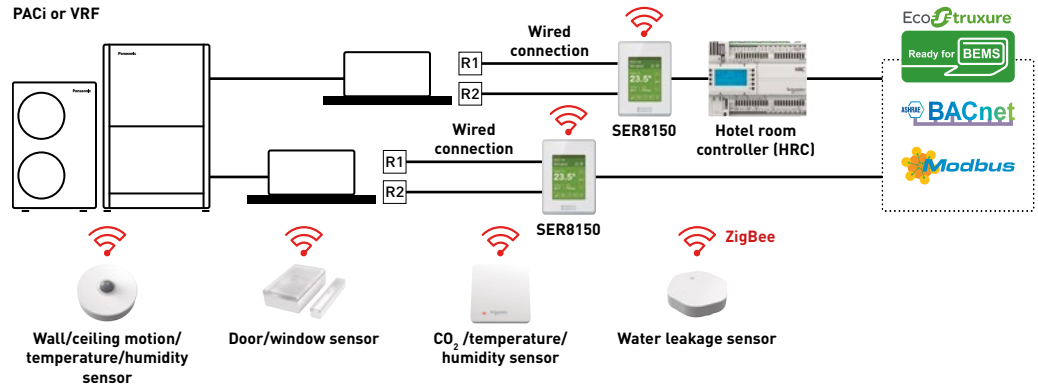

Sensing and control technology

Using sensors from Schneider Electric, high-quality occupancy and automatic IAQ control are realised. The sensors detect the presence or absence of occupants, and the opening and closing of doors and windows to achieve the most efficient energy management and exceptional air-conditioned comfort.

Flexible installation is possible to match different applications and building features such as walls, ceilings and proximity to doors and windows. No wiring means extra installation versatility.

Batteries last for up to five years (10-year battery for CO₂ sensor) and are easy to install and replace.

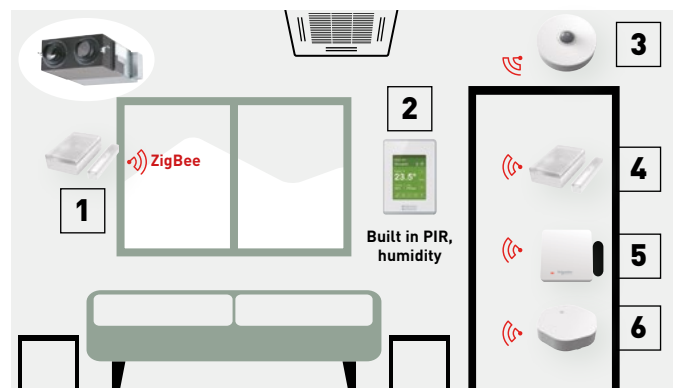

- 1 | Window sensor (option).
- 2 | Room controller.
- 3 | Ceiling motion sensor (option).
- 4 | Door sensor (option).
- 5 | CO₂ sensor (option).
- 6 | Water leakage sensor (option).



Pana Net Con, RH, No PIR, SE Brand, R1R2.
SER8150R0B1194



Pana Net Con, RH, PIR, SE Brand, R1R2.
SER8150R5B1194



Wireless ZigBee® Pro communication card.
VCM8000V5094P



Hotel room expansion module 14 indoor units.
HRCEP14R



Hotel room controller 28 indoor units.
HRCPBG28R



Hotel room controller w/display 42 indoor units.
HRCPDG42R

* Those accessories require system integrator support on site.



Sensor with room CO₂, temperature and humidity.
SED-C02-G-5045



Sensor with room temperature and humidity.
SED-TRH-G-5045



Door/window sensor.
SED-WDC-G-5045



Wall/ceiling motion/temperature/humidity sensor.
SED-MTH-G-5045



Water leakage sensor.
SED-WLS-G-5045



Cover frame. Silver.
FAS-00



Cover frame. White.
FAS-01



Cover frame. Glossy translucent white.
FAS-03



Cover frame. Light tan wood.
FAS-05



Cover frame. Dark brown wood.
FAS-06



Cover frame. Dark black wood.
FAS-07



Cover frame. Brushed steel finish.
FAS-10

Up to 5 year battery life (batteries included). Battery life of CO₂ sensor up to 10 years. Battery level is a data point.

VRF Smart Connectivity+

Smart management solutions.



1 Hotels

Room key card or key cardless solutions for hotels.
The SER8150 and ZigBee sensor automatic detection function offer optimal air conditioning regardless of whether there is a hotel room key or not. Sensors detect the presence or absence of occupants and the opening and closing of doors and windows for the optimum air-conditioned environment guests expect. Automatic control ensures the most efficient operation when guests are away or when windows are open. This contributes to an appreciable reduction in operating costs.



2 Small and medium offices

CO₂ sensors (option) and humidity sensors.
CO₂ sensors take measurements in units of ppm, and humidity sensors enable fine air quality control. This creates the most comfortable space for occupants while contributing to improved employee satisfaction.



3 Super markets

Humidity sensors.
Humidity sensors enable automatic dehumidification for the optimum IAQ regardless of climatic conditions. This creates an even more comfortable environment for customers and employees.

Innovative and unrivalled advantages

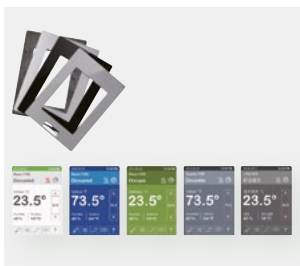

Colour and design to match office interiors.
Colour combinations and design can be set to match different facilities.



Easy-to-understand error description.
Error description during an emergency is easy to understand, enabling staff to respond quickly.

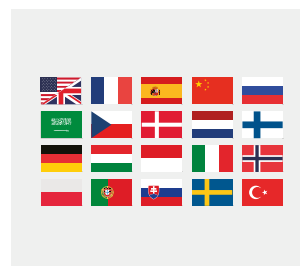

Customisation in 22 languages possible.
The display can be customised to match the native languages of guests to enable smooth, stress-free communication for hospitality at its finest.

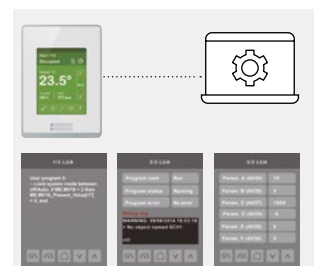

Programmable logic.
Full customisation and updating of remote controller logic to match conditions.

Smart multi-site control solution

Modern and scalable energy management for your Heating & Cooling Solutions.

Smart multi-site control solution. One screen with endless possibilities.

The smart multi-site control solution from Panasonic allows you to have complete control of all your installations. With a simple click, all your units from several locations receive status updates in real-time, preventing breakdowns and optimising costs.





Installation.
Easy installation and configuration.



Connectivity.
A standard LAN connection with internet access (fibre or mobile).

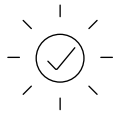

Reliability.
24/7/365 days connection.



Use.
Real-time control from anywhere.



Roles and permission.
Easily configure different access roles for each user.



Security.
Highly secure communication and complaint with GDPR.

What Panasonic provides you?



Energy savings.

AC can be between 40-60% of the total electricity bill.

Even small setting changes can provide a huge impact in energy savings for your buildings. Panasonic AC Smart Cloud provides you energy consumption data of your site(s) and energy saving functions such as control setting limitation, auto off, scheduling, temperature range limits, etc.



Healthy comfort.

How to secure a comfortable environment by avoiding incorrect AC operation?

Incorrect temperature settings can create discomfort for users as well as an unhealthy environment for employees, visitors or customers. Analyse the set point and room temp history, and fix the right mode and temperature for each room.

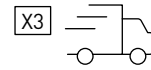

Service speed.

On average, 2-3 AC technician' visits are required on site when an error/issue appears in an AC system.

Avoid wasted site visits, analysing the behavior of the AC system remotely without the need of a technician visit on site.



Downtime.

System "downtime" can impact the customers buying experience / productivity.

Keep your business running, reducing the risk of system downtime. Detect potential failures in advance or fixing them swiftly should issues occur.



Maintenance.

A proper maintenance schedule prevents future malfunctions and reduces energy consumption.

Remotely check all the advanced parameters of the system and plan the maintenance properly. Assign the right engineer for the required task.



Life of system.

Replacing HVAC is a huge impact on investment.

Making good use of the system, taking earlier action when abnormal signal occurs and keeping regular maintenance will expand the life your system, but will also keep the expected performance operation.

Full multi-site and user control

Panasonic Smart and Service Cloud is based on location. Each location can allow access for multiple users whether in the same building or via remote access. The scalability allows addition of multiple sites and customise the access of your team and the access of your trusted service partner.

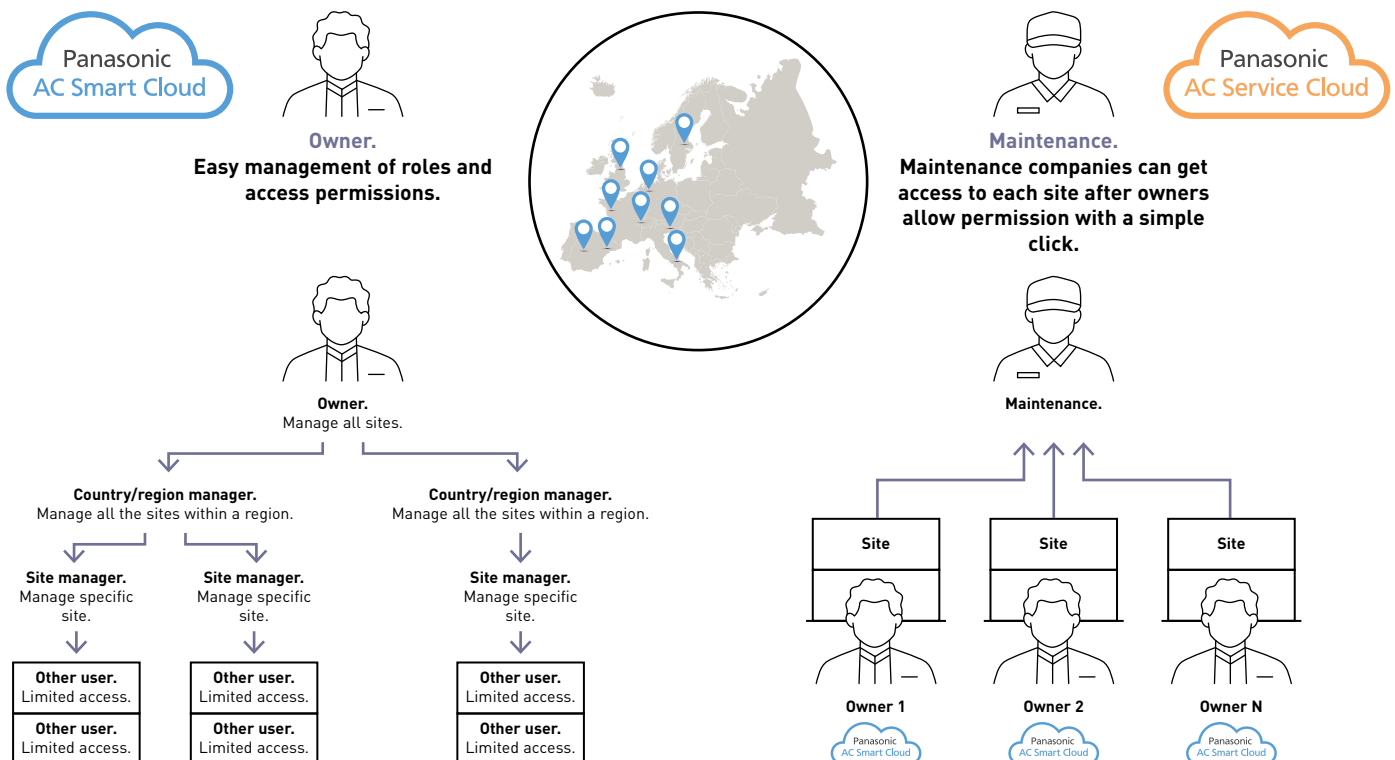

Panasonic AC Smart Cloud

Centralise control of your business premises, from wherever you are, 24/7/365. The AC Smart Cloud system from Panasonic allows you to have complete control of all your installations from your tablet or from your computer. In a simple click, receive status updates, from all of your installations wherever the location, reducing potential breakdowns and optimising costs.



1 Comfort
Keep the comfort of workers, visitors, and customers to increase satisfaction and productivity.

2 Return on investment
Optimising the operation of your heating and cooling system and the possibility to monitor remotely can expand the life of your assets.

3 Lower running cost
Controlling settings in real-time and monitoring energy consumption contributes to reducing your energy bill.

Flexible solution for your business

Scalable solution for your business



Anytime



Anywhere

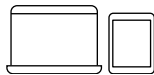

Multiplatform

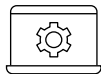

Internet browser

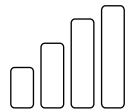

Small to large

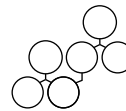

1 to multi-sites

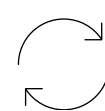

Upgrade features ¹⁾

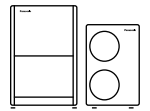

RAC²/PACi/ECOi/ECO G

1) Customized to meet user demand / Continuous upgrades: new functions and product introductions / IT smart management. 2) CZ-CAPRA1 is required.

Key functions and uniqueness



Multi-site monitoring.
· It doesn't matter how many sites you have. It is easy to manage, operate, compare sites, locations and rooms.



Powerful statistics for energy savings.
· Power consumption, capacity and efficiency level can be compared with different parameters (yearly / monthly / weekly / daily basis)



Schedule setting.
· Set yearly / weekly / holidays timers as you please



Maintenance notification.
Receive an error notification by email with floor layout:
· Maintenance notification of ECOi / ECO G outdoor units
· Remote service checker function

Controller multi-site.

Including all advantages for single site, the scalability of AC Smart Cloud offers you an excellent toll for multi-site management.

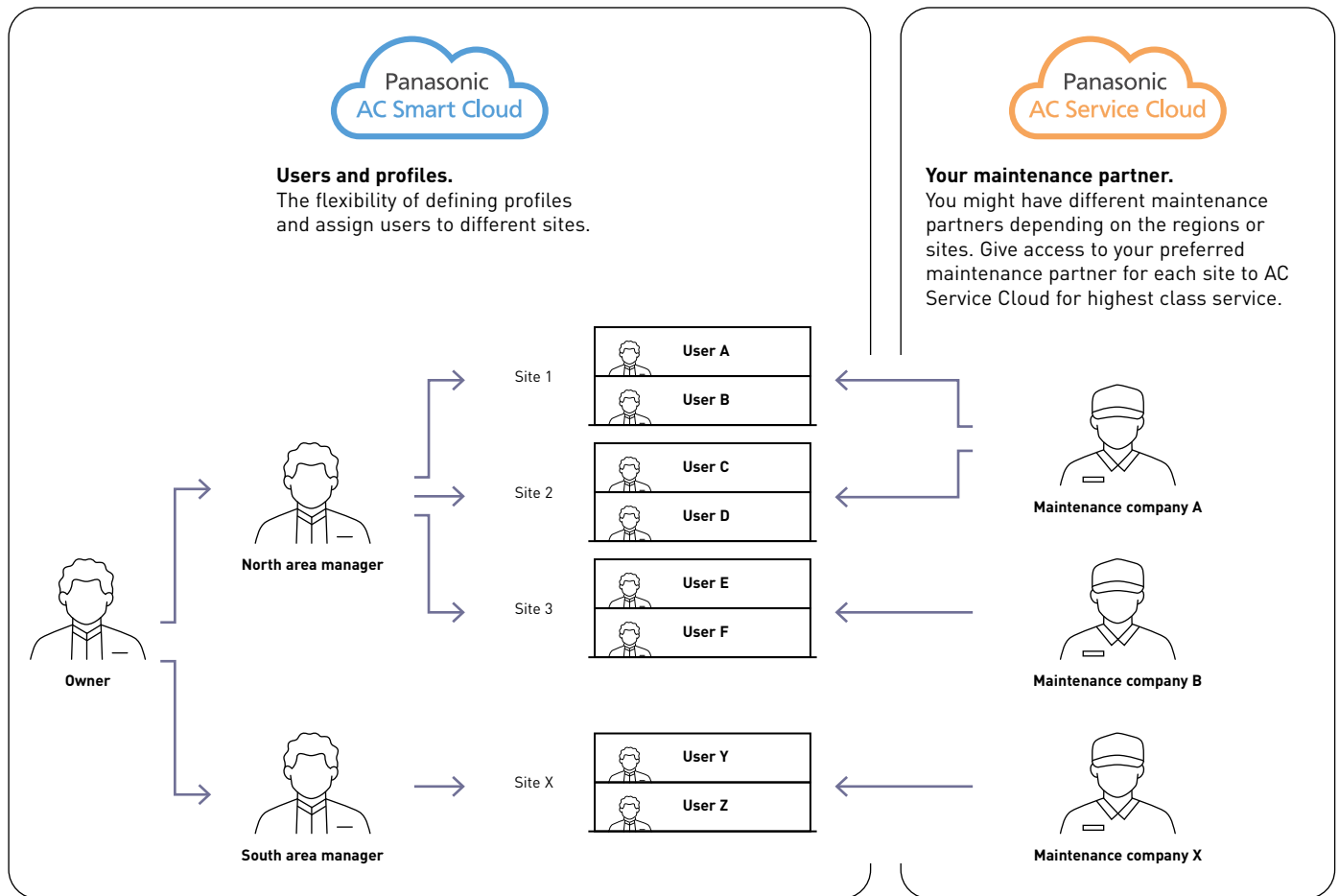

List of features

Panasonic AC Smart Cloud	Functionalities
Home screen	Overview of: operating status, location map, weather information, notification, energy consumption, efficiency, eco-friendly building list
AC settings	Indoor unit monitoring and remote control, outdoor unit details, cloud adapter details, floor map view, maintenance notification (installer)
Visualization	Statistical data regarding energy consumption, capacity and efficiency ranking; per indoor unit, unit group or refrigerant circuit
Notification	Warnings and alarms, maintenance intervals
Schedule	Schedule settings and results
Energy saving	Temperature range limits, unattended auto shutoff, temperature auto return, energy saving timer, demand/peak shaving
Demand control	Indoor unit and outdoor unit demand settings
Event control	Control inputs: alarms, digital inputs, indoor units. Control outputs: digital outputs, indoor units
System settings	CO ₂ factor, distribution groups, area allocation, cut-off requests, site management, group display, site location, software version
User account	New user registration, updating users, user lists, user roles
Floor map Editor	Floor map import and unit assignment
Help	Installer information, alarm mail setting, user data, account management, company / customer information, terms of use, privacy notice, cookie policy, user manual, FAQ. For installers: user manual, technical data, installation instructions
Additional functions for installers	Cloud adapter installation process, remote service checker data recording and download, remote cloud adapter firmware update

Panasonic AC Service Cloud

Panasonic AC Service Cloud provides maintenance companies a unique tool to deliver advanced service and maintenance features, decreasing response times, reduce sites visits and better allocate resources.

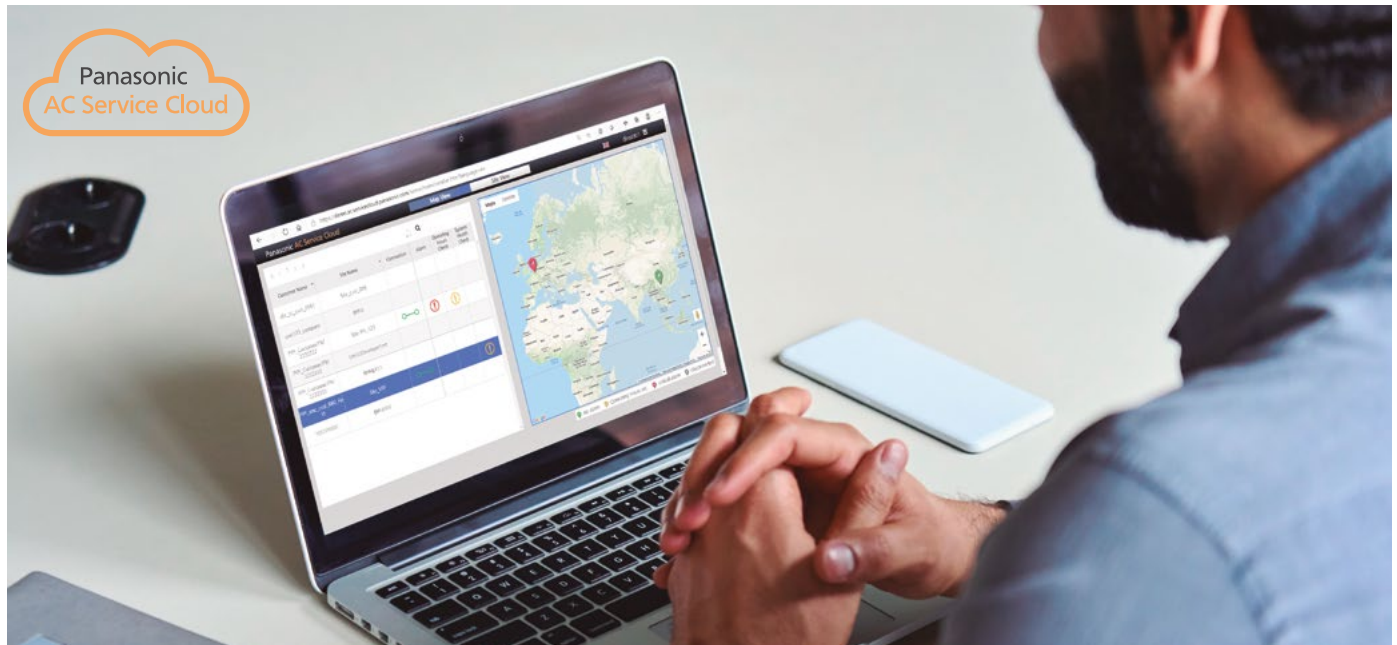

1 Response time and zero down time
Providing technical information about abnormalities and checker functions enables the AC installer and maintainer to remotely identify and fix issues more quickly, even before they occurs.

2 Reduce unnecessary trips
It reduces the cost of unnecessary trips, reducing the CO₂ emissions associated with transport.

3 Maintenance planning
With a simple click, easily identify the nature of potential issues, enabling issue classification, prioritisation of resources and better planned site visits, assigning the right engineer for the job.

4 All at a glance with scalability
Remotely view all sites requiring maintenance of Panasonic HVAC. Increase the number of sites maintained, taking advantage of future updates and features of the Panasonic AC Service Cloud.

Key functions

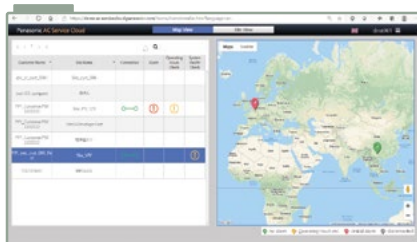

All sites at a glance.



Topology.

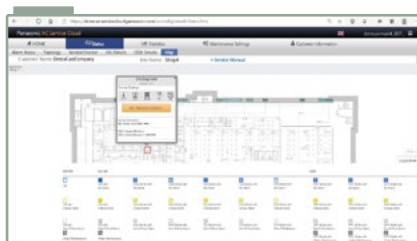

Floor map view.

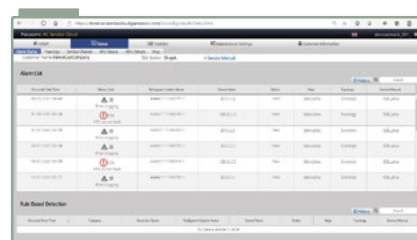

Alarm status.

Owners can manage different maintenance companies for each site, enabling or disabling access with just one click. Maintenance companies can have access to all sites where different owners allow permissions.

System health check function

Self diagnosis function is available in the AC Service Cloud. It automatically predicts potential malfunctions and helps to speed up your service process.

- Consecutive automatic monitoring at 15 minute intervals
- Key notifications in the event potential malfunction is detected
- 2D graph display to help with detailed analysis
- Threshold values can be easily adjusted

* For compatible models, please contact an authorized Panasonic dealer.

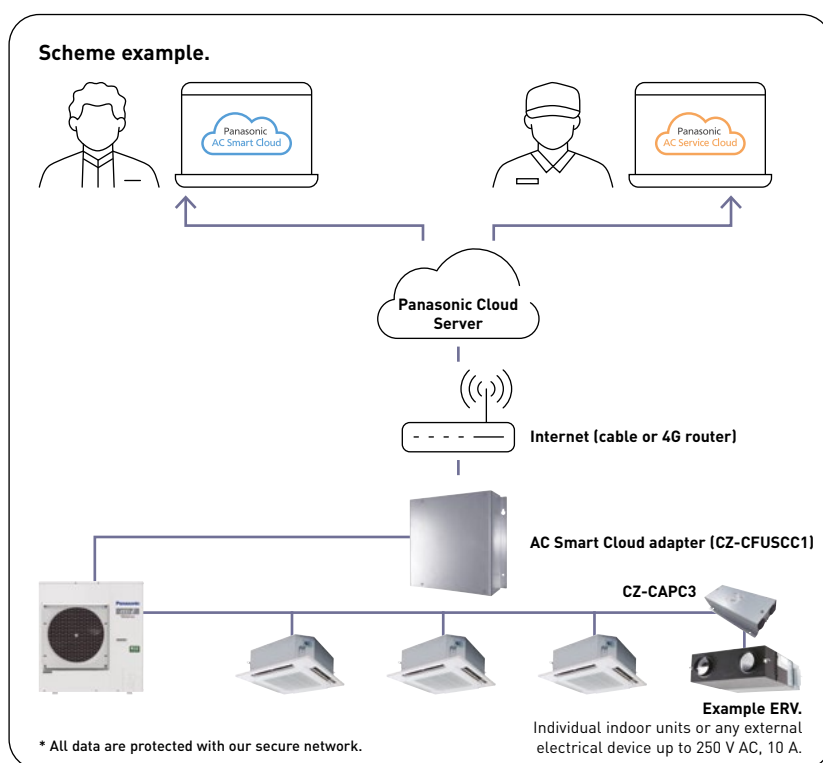
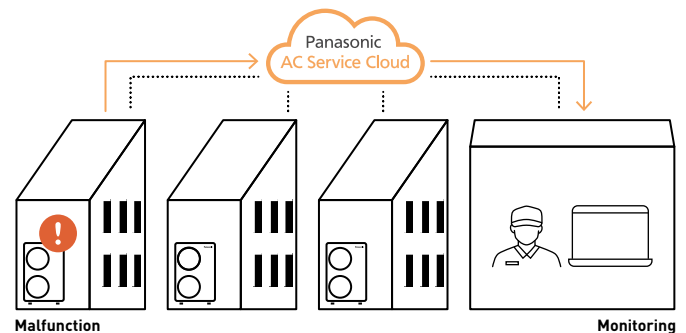

Technical requirements:

- CZ-CFUSCC1 – AC Smart Cloud adaptor
- Internet connection via: LAN with access to internet

Optional hardware:

- CZ-CAPRA1 – integration of RAC systems
- Pulse meters (supplied by others): up to 3 pulse meters (gas or power meters) can be connected to the cloud adaptor, extendable by additional communication adapters (CZ-CFUSCC2)
- CZ-CAPC3 - ON / OFF monitor and control

Systems supported by AC Smart Cloud adaptor:

- ECOi
- ECO G
- PACi / PACi NX
- RAC (CZ-CAPRA1 interface is required)
- ERV (CZ-CAPC3 interface is required)

List of features

Panasonic AC Service Cloud Functionalities	
Home screen	Map view and site view with site names, connection status and alarm status
Status	Alarm status, site topology, remote service checker, indoor unit monitoring and remote control, outdoor unit details, floor map view with service manual download
Statistics	Refrigerant circuit view (current data and recorded data), data table view, 2D graph view
Maintenance settings	Notifications and alarms, maintenance intervals setting (operating hours)
Customer list	List of connected customers, requests to access customer sites
Cloud adaptor	Cloud adaptor installation wizard, remote firmware update
Floor map editor	Floor map import and unit assignment
Help	Alarm mail setting, user data, account management, company / customer information, terms of use, privacy notice, cookie policy, user manual, user manual, technical data, installation instructions, FAQ
System health check function*	Self diagnosis function is available in the Panasonic AC Service Cloud. It automatically predicts potential malfunctions and helps to speed up your service process

* Optional.

1 Panasonic AC Smart Cloud packages

Get the cloud base kit (CZ-CFUSCC1 + start up) and register to one of the subscription periods with or without data connectivity.

The selection of the right Panasonic AC Smart Cloud package depends on the size of the installation.

	Product	Reference	Items included in a kit	Description
Up to 32 indoor units	Cloud base kit	KIT-ACSCBASE32	CZ-CFUSCC1	Cloud adapter for ECOi, PACi and ECO G ¹⁾
			SR-ACSCSTART32	AC Smart Cloud start up to 32 indoor units
	AC Smart Cloud access fee		SR-ACSC1Y32	AC Smart Cloud access fee for 1 year
			SR-ACSC3Y32	AC Smart Cloud access fee for 3 years
			SR-ACSC5Y32	AC Smart Cloud access fee for 5 years
AC Smart Cloud access fee with data connectivity	SR-ACSC1Y32CNT		AC Smart Cloud access fee for 1 year with data connectivity	
Up to 64 indoor units	Cloud base kit	KIT-ACSCBASE64	CZ-CFUSCC1	Cloud adapter for ECOi, PACi and ECO G ¹⁾
			SR-ACSCSTART64	AC Smart Cloud start up to 64 indoor units
	AC Smart Cloud access fee		SR-ACSC1Y64	AC Smart Cloud access fee for 1 year
			SR-ACSC3Y64	AC Smart Cloud access fee for 3 years
			SR-ACSC5Y64	AC Smart Cloud access fee for 5 years
AC Smart Cloud access fee with data connectivity	SR-ACSC1Y64CNT		AC Smart Cloud access fee for 1 year with data connectivity	
Up to 128 indoor units	Cloud base kit	KIT-ACSCBASE128	CZ-CFUSCC1	Cloud adapter for ECOi, PACi and ECO G ¹⁾
			SR-ACSCSTART128	AC Smart Cloud start up to 128 indoor units
	AC Smart Cloud access fee		SR-ACSC1Y128	AC Smart Cloud access fee for 1 year
			SR-ACSC3Y128	AC Smart Cloud access fee for 3 years
			SR-ACSC5Y128	AC Smart Cloud access fee for 5 years
AC Smart Cloud access fee with data connectivity	SR-ACSC1Y128CNT		AC Smart Cloud access fee for 1 year with data connectivity	
Up to 512 indoor units	Cloud base kit	KIT-ACSCBASE512	4x CZ-CFUSCC1	Cloud adapter for ECOi, PACi and ECO G ¹⁾
			SR-ACSCSTART512	AC Smart Cloud start up to 512 indoor units
	AC Smart Cloud access fee		SR-ACSC1Y512	AC Smart Cloud access fee for 1 year
			SR-ACSC3Y512	AC Smart Cloud access fee for 3 years
			SR-ACSC5Y512	AC Smart Cloud access fee for 5 years
AC Smart Cloud access fee with data connectivity	SR-ACSC1Y512CNT		AC Smart Cloud access fee for 1 year with data connectivity	

1) The adapter has to be sold always together with start up. * One cloud adapter is required per 128 indoor units. ** Model references up to 192/256/320 indoor units are also available.

2 Panasonic AC Service Cloud

	Product	Reference	Description
Service function	Panasonic AC Service Cloud	SR-ACSC1Y32M	AC Service Cloud access for 1 year up to 32 indoor units
	System Health Check ²⁾	SR-ACSC1Y32SHC	System Health Check access for 1 year up to 32 indoor units

2) AC Service Cloud is required to use this function.

3 Optional services

Product	Reference	Items included in a kit	Description
Floor map ³⁾	SR-ACSC1FLRUP		Upload 1 floor map or maximum 32 units
Floor map ³⁾	SR-ACSC1FLRCP		Create 1 floor map or maximum 32 units
Indoor assign ³⁾	SR-ACSC32ASSIGN		Assign indoors up to 32 units
4G connectivity kit ⁴⁾	KIT-ACSC4GCNT	PAW-ACSCRTR4G PAW-ACSCSIM	AC Smart Cloud 4G connection kit including 4G router and SIM card
4G Router	PAW-ACSCRTR4G		4G Router for Panasonic AC Smart Cloud
SIM card	PAW-ACSCSIM		SIM card without data amount

3) Floor map and indoor assignments can be done by customer without additional charge. 4) Data amount of SIM card is not included.

Selection steps

What service do you need? There are 2 options as follows.

AC Smart Cloud only.



Please follow step: **1**

AC Smart Cloud + AC Service Cloud.



Please follow step: **1 2**

* AC Smart Cloud is always required to use Panasonic AC Service Cloud.

1 Setup for AC Smart Cloud.



Cloud adapter.
(CZ-CFUSCC1)



Start up.
Depending on the size of the installation.
SR-ACSCSTART



1, 3 or 5 years

1 | Determine your number of indoor units.

2 | Select the appropriate cloud base kit.

3 | Choose your subscription length.
The subscription with data connectivity is also available.

* One cloud adapter (CZ-CFUSCC1) is required per site.

2 Setup AC Service Cloud



The service cloud subscription (SR-ACSC1Y32M) is for up to 32 indoor units as standard. For larger systems exceeding this indoor unit quantity, multiple packages are required. For example, please order 2 units of SR-ACSC1Y32M if the number of indoor units is from 33 to 64. If system health check function is required in AC Service Cloud, choose SR-ACSC1Y32SHC.

3 Choose optional services to suit your needs.

- Floor map upload
- Floor map creation
- Indoor assign
- Power meter
- 4G connectivity



Commercial Wi-Fi Adaptor

Panasonic CZ-CAPWFC1 interface adaptor, allows connection of one or a group of indoor units to Panasonic Comfort Cloud App, which provides control, monitoring, scheduling, and error alerts. Control PACi, ECOi, and ECO G indoor units with your smartphone whenever and wherever you are, by using Panasonic Comfort Cloud App and Commercial Wi-Fi Adaptor.



1 From 1 to 200 units
 User can control up to 10 different sites, with up to 20 units / groups per site. Additionally, one adaptor can be connected to 1 indoor or to a group of up to 8 indoors.

2 Voice control compatible
 Registering the unit to Panasonic Comfort Cloud App makes it compatible with the most popular voice assistants.

3 Multi user
 The Panasonic Comfort Cloud App allows multi-user access control, whilst allowing user restriction to specific units.

4 Easy scheduling
 Complex weekly scheduling made simple. Not only for one unit, but across multiple sites, and from a smartphone.

5 Energy monitor
 See the estimated power consumption and compare with other periods, to see how energy consumption can be further reduced. Check list of units that provides consumption*.

* Function available depending on the model.

6 Error codes
 Error code notification through the App, provides early notification and allows for faster repair.



Advanced smartphone control

This scalable solution is ideal for one system, one site or multiple locations. Coupling the adaptor with the already feature rich systems, makes it an ideal solution for residential and commercial applications.



Connection Diagram

Commercial Wi-Fi Adaptor wiring length is 1,9 m and connects to indoor unit via T10 connector and R1/R2 terminal connectors.

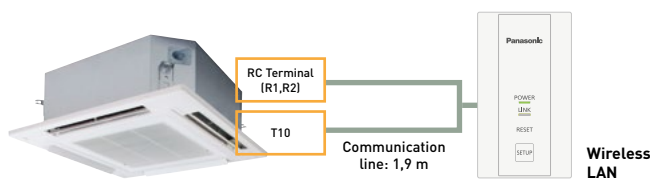

Input Voltage	DC 12 V (supplied from T10 connector)
Power Consumption	Maximum 2,4 W
Size (HxWxD)	120 x 70 x 25 mm
Weight	190 g (including communications lines)
Interface	1 x Wireless LAN
Wireless LAN Standard	IEEE 802,11 b/g/n
Frequency Range	2,4 GHz band
Operating range	0 ~ 55 °C, 20 ~ 80 RH%
Connectable indoor unit	1 unit
Length of communication line	1,9 m (included)

Download free app: Panasonic Comfort Cloud App.

Other hardware requirements: Router and Internet (purchase and subscribe separately).

Panasonic Cloud Server is designed, operated and managed by Panasonic.

CONEX. Devices and apps

CONEX provides comfort and control for varying user needs. Accessible, flexible, and scalable with different controllers and apps. Perfectly meeting requirements of modern controls for end user, installer, and service. With nanoe™ X function, technology with the benefits of hydroxyl radicals.



New 2023



Intuitive operation with simple and modern design panel.
Sophisticated design with white or black flat panel and compact body. From residential to commercial, the wired remote controller series perfectly matches with all kinds of modern building.
It enables user to recognize each function with a simple glance.

1 Intuitive control with stylish design

- Simple operation at a glance
- Clean face with full flat and LCD display
- Compact body, only 86x86 mm

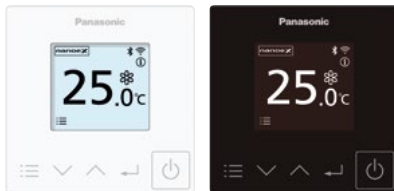

2 Control comfort with your smartphone

- Flexible control options with IoT integration
- Panasonic H&C Control App for daily remote control operation
- Panasonic Comfort Cloud App for remote operation 24/7/365

3 Easy maintenance with service support app

- Quick and easy app set-up for system setting
- Panasonic H&C Diagnosis App enables the user to obtain detailed system operation data*

* The use of apps depends on the remote controller model.

CONEX with IoT integration

CONEX

The wired remote controller series is fully integrated with IoT solutions developed by Panasonic. Detailed operation, maintenance setting and service operation are all possible with smartphone or tablet.



https://youtu.be/_USzG_9f6bk

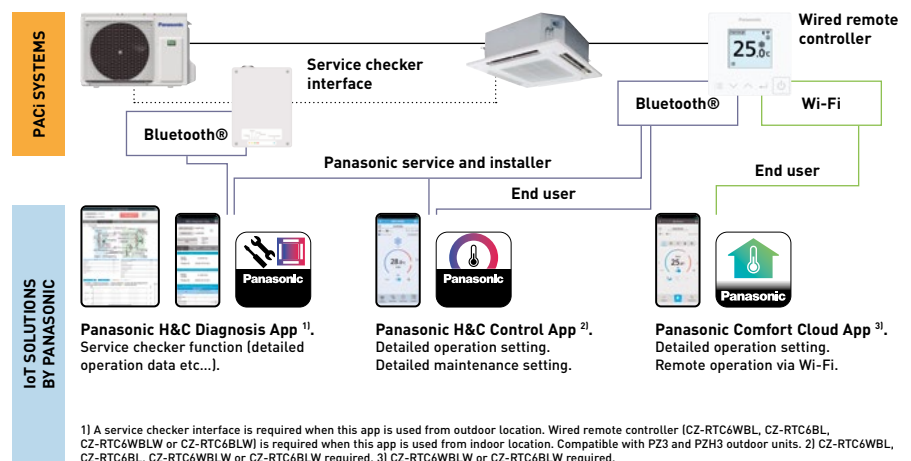

Service checker interface.

The service checker interface provides easy access to service parameters and service checker data via Bluetooth®.

- A Service checker interface for PACi NX Series*
- Bluetooth® connection
- Panasonic H&C Diagnosis App

* Available as a spare part, compatible with PACi NX Series.

Input voltage	220-240 V ~ 50-60 Hz (supplied from outdoor unit)
Power consumption	Maximum 2,4 W (including outdoor units)
Size (HxWxD)	175 x 125 x 50 mm
Weight	—
Interface	Bluetooth® 4.2 or later
Frequency range	2,4 GHz band*
Operating range - Temperature / Humidity	0 ~ 40 °C / 20 ~ 80% (no condensation)

* Frequency band in which the radio equipment operates; 2402 - 2480 MHz.

* Maximum radio-frequency power transmitted in the frequency bands in which the radio equipment operates; +0 dBm.



CONEX. Devices and apps

Flexible control options with IoT integration. 3 different apps for individual usage.

Panasonic H&C Diagnosis App for service and installer

Tool for diagnosis and troubleshooting.

Available functions:

- AC control
 - System view
 - Refrigerant circuit view
- Real-time data
 - Indoor unit
 - Outdoor unit
- Refrigerant cycle diagram and graph
- Data recording
- History data
- Error code tables

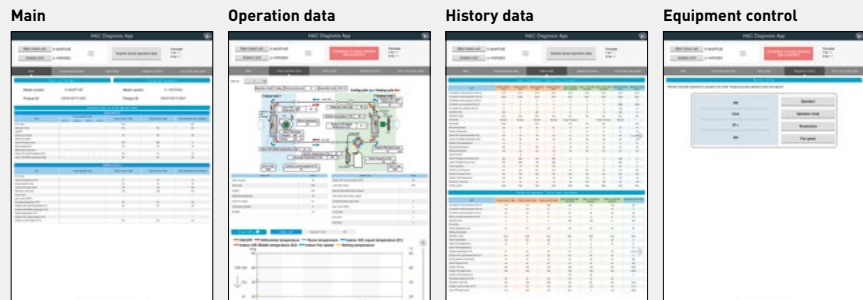

Panasonic H&C Control App for end user, service and installer

Detailed operation setting. Detailed maintenance setting.

Available functions:

- ON / OFF, mode, temperature, air flow volume, air flow direction
- Weekly timer
- All energy saving functions
- Alarm display and history
- Filter sign
- Test run
- Sensor value monitor
- Simple setting mode
- Detailed setting mode
- Key lock
- Ventilation fan control
- Display contrast adjustment
- Rotation, redundancy
- Quiet mode
- nanoe™ X
- Power consumption
- Unit naming

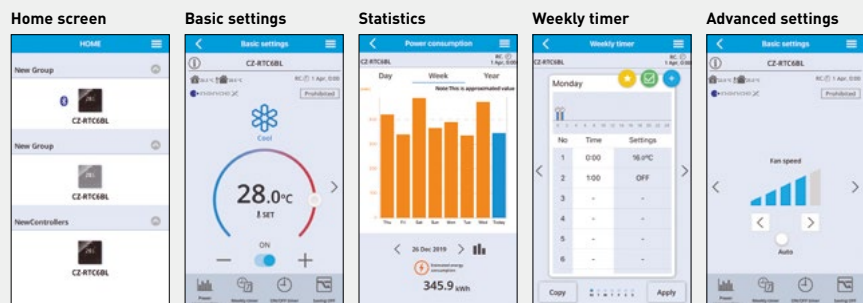

Panasonic Comfort Cloud App for end user

Remote operation via Wi-Fi.

Available functions:

- ON / OFF
- Mode
- Temperature
- Air flow volume
- Air flow direction
- Weekly timer
- Temperature setting range limitation
- Energy monitoring
- Alarm display
- nanoe™ X







Connectivity matrix.



White model ¹⁾	CZ-RTC6W	CZ-RTC6WBL	CZ-RTC6WBLW
Black model	CZ-RTC6	CZ-RTC6BL	CZ-RTC6BLW
Wired connection compatible with	PACi, PACi NX, ECOi, GHP	PACi, PACi NX, ECOi, GHP	PACi NX only
Wireless functions	No wireless capability	Bluetooth®	Bluetooth® + Wi-Fi
App compatibility			
Panasonic Comfort Cloud App	—	—	✓
Panasonic H&C Control App	—	✓ PACi, PACi NX, ECOi, GHP	✓ PACi NX only
Panasonic H&C Diagnosis App ²⁾	—	✓ PACi NX only ³⁾	✓ PACi NX only ³⁾
Outdoor unit settings (remote controller connected to indoor unit)	✓ PACi NX only ³⁾	✓ PACi NX only ³⁾	✓ PACi NX only ³⁾

1) Available in Autumn 2023. 2) Compatible with U-71/100/125/140PZH3E5/8 and U-100/125/140PZ3E5/8. 3) When connected to PACi NX indoor and outdoor unit combination.

Function comparison

This shows the functions provided:		Remote controller functionalities	Panasonic H&C Control App	Panasonic Comfort Cloud App	
a) by the remote controllers					
b) by the apps					
					
					
		CZ-RTC5B	CZ-RTC6W / CZ-RTC6	CZ-RTC6WBL(W) / CZ-RTC6BL(W) + app	
				CZ-CAPWFC1 + app	
				CZ-RTC6WBLW / CZ-RTC6BLW + app	
Basic operation	ON / OFF, mode, temperature, air flow volume, air flow direction	✓	✓	✓	✓
	Time display	✓	—	✓	✓
Timer functions	Easy ON / OFF timer	✓	—	✓	—
	Weekly program timer	✓	—	✓	✓
	Outing function	✓	✓	✓	—
Energy saving	Temperature auto return	✓	—	✓	—
	Temperature setting range limitation	✓	—	✓	✓
	OFF reminder	✓	—	✓	—
	Energy saving mode	✓	—	✓	—
	Schedule demand control	✓	—	✓	—
	Energy monitoring	✓	—	✓	✓
	Econavi	✓	✓	✓	✓
Maintenance	System failure information (alarm history)	✓	✓	✓	—
	Alarm display	✓	✓	✓	✓
	Service contact registration	✓	—	✓	—
	Filter sign	✓	✓	✓	—
	Test run	✓	✓	✓	—
	Sensor value monitor	✓	✓	✓	—
	Simple setting mode	✓	✓	✓	—
Others	Detailed setting mode	✓	✓	✓	—
	Key lock	✓	✓	✓	—
	Ventilation fan control	✓	—	✓	—
	Display contrast adjustment	✓	✓	✓	—
	Rotation	✓	—	✓	—
	Quiet operation mode	✓	—	✓	—
	nanoe™ X	✓	✓	✓	✓

Remote controller with Econavi

Easy to use, attractive, clear design, with demand control functions and energy consumption display! This useful feature makes this remote controller unique!



1 Design

The CZ-RTC5B wired remote controller is ideal for integration into the most demanding interior architectures.

The touch panel features a very sleek and easy to use display, which with its compact display is only 120 x 120 x 16 mm.

2 Key functions

- Easy setup of the timer and settings of the indoor unit
- Energy consumption display (for all R32 PACi line-up)
- Limitation of the energy consumption (Demand control) by timer.

3 Display of information

The information is mainly based on pictograms to ensure easy understanding. The minimal amount of text is available in 6 languages (English / German / French / Spanish / Italian / Polish).

The screen is back lit to enable reading even during the night.

4 Easy access to the menus

With the pictograms, the navigation, the selection and the settings are simple and easy to follow.

Basic function (operation display and indication).

All functions are easily available on the remote controller.

- ON / OFF timer
- Weekly timer
- Quiet operation
- Remote controller sensor
- Operation prohibit
- Filter sign
- Energy saving
- Centralized control indication
- Mode change prohibit
- Automatic temperature return
- Temperature range limitation
- OFF remind
- Schedule demand control
- Ventilation
- Out Function

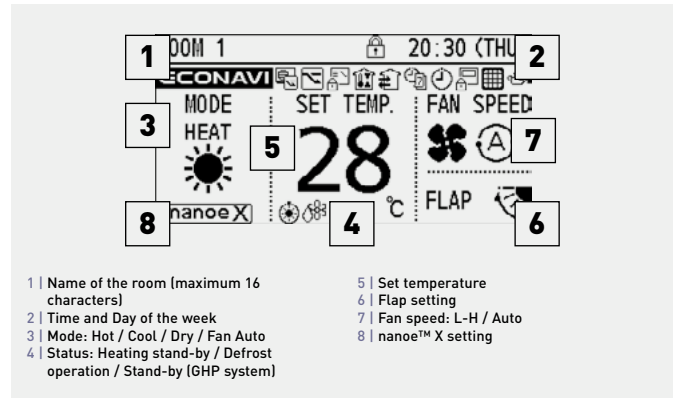

- 1 | Name of the room (maximum 16 characters)
- 2 | Time and Day of the week
- 3 | Mode: Hot / Cool / Dry / Fan Auto
- 4 | Status: Heating stand-by / Defrost operation / Stand-by (GHP system)
- 5 | Set temperature
- 6 | Flap setting
- 7 | Fan speed: L-H / Auto
- 8 | nanoe™ X setting

Easy operation and quick access to all menus

- 1 | Set temperature will be selected, when any arrow button is touched
- 2 | Select the item (Mode or Fan speed) by left/right ◀▶ key
- 3 | Change the setting by up/down ▲▼ key

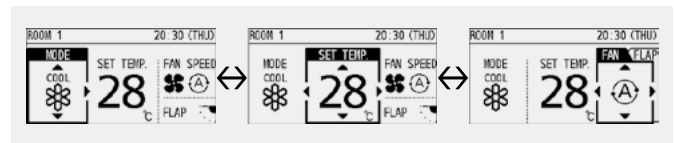

Example of easy access to the functions: air direction setting

- 1 | Select "Air direction" and press "Enter" key
- 2 | Select the unit number by up/down ▲▼ key
- 3 | Select the flap position by up/down ▲▼ key
- 4 | Press "Return" key to go back the Menu display

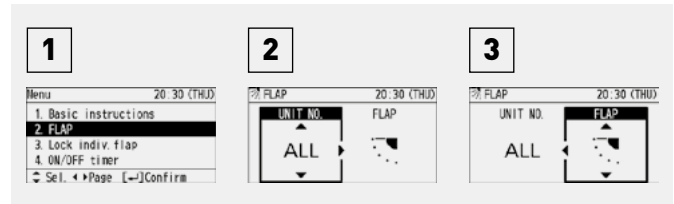

Backup control by using CZ-RTC5B

Group wiring of 2 systems of PACi can do auto individual control: Rotation operation, backup operation and support operation.

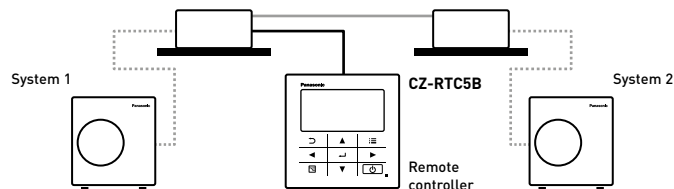

Functions available on the CZ-RTC5B

Control item	Controllability	Indoor units	
		PACi	VRF
Basic operation	Operation, Mode, Temperature setting, Air flow volume, Air flow direction	✓	✓
	Time display	✓	✓
Timer function	Easy ON / OFF timer	✓	✓
	Weekly program timer	✓	✓
	Outing function	✓	✓
Energy saving	Temperature auto return	✓	✓
	Temperature setting range limitation	✓	✓
	OFF remind	✓	✓
	Energy saving mode	✓	✓
	Schedule demand control	✓ ¹⁾	✓
	Energy monitoring - R32	✓	—

Control item	Controllability	Indoor units	
		PACi	VRF
Maintenance	System failure information	✓	✓
	Service contact registration	✓	✓
	Filter sign (rest time display) and reset	✓	✓
	Auto-address, Test run	✓	✓
	Sensor value monitor	✓	✓
Others	Simple / Detail setting mode	✓	✓
	Key lock	✓	✓
	Ventilation fan control	✓	✓
	Display contrast adjustment	✓	✓
	Remote controller sensor	✓	✓
	Quiet operation mode	✓ ¹⁾	—
	Prohibit setting control from central controller	✓	✓

1) Not available with PACi Standard R410A line up.
+ All specifications subject to change without notice.

Datanavi

Datanavi, a simple way to connect.
Simple and easy support tool with your smartphone.



Overview of datanavi system.

Just holding up your smartphone to the LED display on a remote controller (CZ-RTC5B) to receive useful AC system information super fast by Panasonic Light ID Technology. Datanavi also connects to Panasonic Cloud Server for the quick view of manuals, saving data received by Light ID.



- Fast and intuitive
- Easy access to manual database
- Accurate service data on your smartphone

Key functions.

- Scan and Save AC system info
- Easy access to manual database
- Commissioning, F-Gas check data history

What is the Light ID technology developed by Panasonic?

Visible light transmission technology, which enables to transmit information by high-speed and invisible flashing of an LED light source.

User / administrator (person in charge of AC) functions

- **Fast and intuitive.** Regular operation data, energy consumption data display
- **Easy access to data base.** Getting manuals related on demand
- **No idea what to do when an error happens?** You can share error information and contact service easily

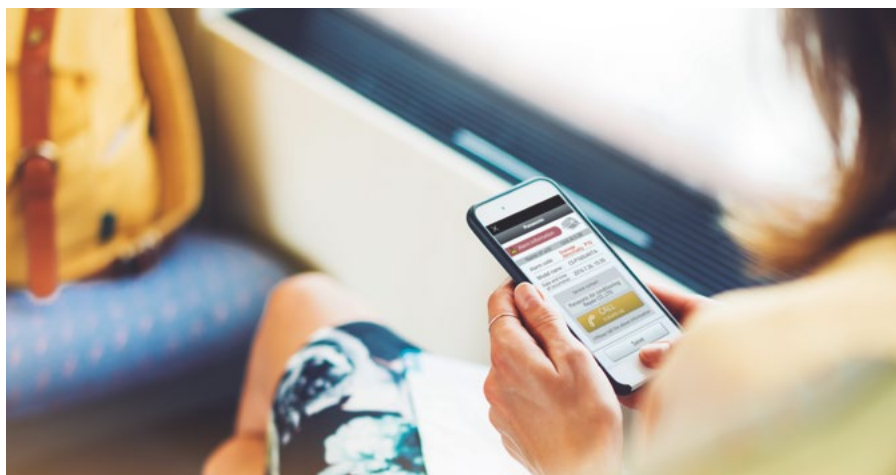

Installer / service company functions

- **Getting technical data depends on your need**
Service manual. Q and A list. Test run information
- **Accurate error information**



Regular operation

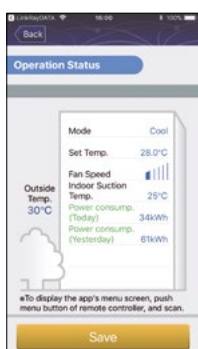

Energy management

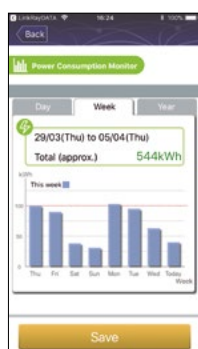

Malfunction notice

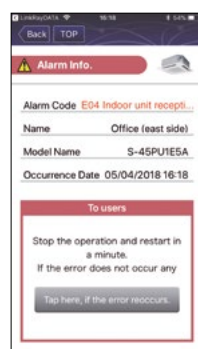

Operating manual



Test run info

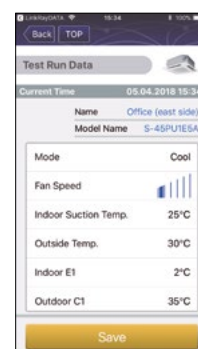

Service data



* User interface image may be updated without notification.

- Simple F-gas regulation check list
- Repair speed check list

Download free apps, try datanavi!



Download on the App Store



GET IT ON Google Play

Intelligent controller

This controller is the smart solution for your advanced requirement in buildings.



Intuitive operation.

The screens used for operations all follow a common pattern, with the screens being easy to read and easy to use.

- Enlarged screen (10,4 inch) with colour LCD
- Smartphone-like gestures (flick, swipe, touch)

Large screen display. Enlarged by 60%.



Easy swipe or flick operation.

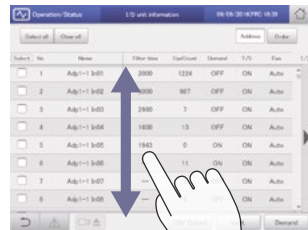

Swipe.
This is an operation where the finger is slid in a direction (up or down) on the touch panel. This is used to scroll slowly.

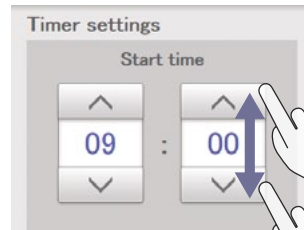

Select.
This is an up and down movement of the finger touching the screen, used to pick settings in elements such as spin boxes.

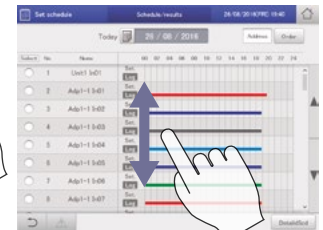

Pull out.
This is an operation where the finger on the touch panel is flicked in a direction (up or down). This is used to scroll quickly.

Enhanced functions for energy saving as standards

- Set temperature auto return settings, Auto shut OFF, set temperature range limit settings
- Demand control function

Screen of set temperature auto return setting.

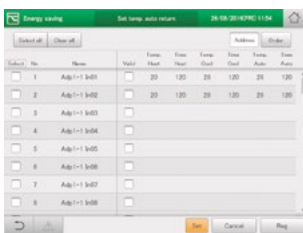

Auto shut OFF.



Screen of outdoor demand control.

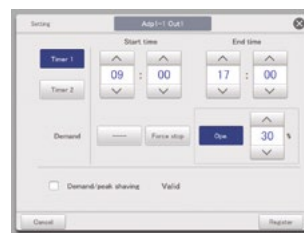

- Outdoor demand input and timer settings possible
- Indoor can be set at $\pm 1\text{ }^{\circ}\text{C}$ / $\pm 2\text{ }^{\circ}\text{C}$ or thermostat OFF
- Indoor units controlled in sequence at 10-minute intervals

Energy visualization

- Energy saving plans are supported with graph display function
- Displays electricity and gas usage distribution

Screen of graph display.

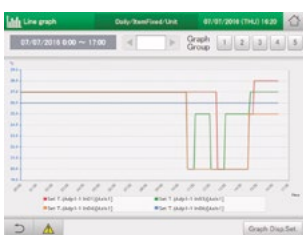

Useful parameters are shown for your better energy saving. Ex.) Bar graph:

Indoor unit: Total operating time, thermostat ON operation time (Min.)
Amount used (electricity, gas)
Electricity or gas charges

Outdoor unit: Outdoor unit operation cycles (# cycles)
Engine time in operation (Hrs.)
Cumulative Inverter power output
Cumulative PV power output

Pulse value selection per different data intervals 1 hour/1 day/ 1 month compared with last year.

Main function

Gesture function (flick, swipe, touch)	✓
Graph display (trends, comparisons)	✓
Web functions (maximum 64 users)	✓
Recipient setting for warning email	✓ (Maximum 8)
Automatic return to setting temperature	✓
Limitation of setting temperature range	✓
Left-on prevention	✓
Quiet operation of outdoor unit	✓
Occupant sensor linkage	✓
Demand function	✓
Charge calculation	✓
Log display	✓ Warning 10000 items. Status change 50000 items
Linked control (event definition 50 events, input: 32, output: 32)	✓
Under maintenance (under inspection registration)	✓

Econavi Sensor

The Econavi sensor detects presence in the room, and quietly adapts the PACi or VRF air conditioning system in order to improve comfort and energy savings.



- Detects human activity and adjusts temperature by 2 degrees (up or down) to optimise comfort and efficiency
- If there is no activity detected for a set time period, the Econavi will stop the unit or move to a temperature previously set
- The Econavi device is installed independently of the indoor unit, and is located in the area best suited for detection

Applications

Saving energy for offices: If the air conditioning is left on after the last employee leaves the office, Econavi will automatically react, reducing or stopping the system. **Increased comfort in hotel rooms:** When presence is detected in the room, the temperature is automatically adjusted to achieve best comfort.

Key points

- Compatible with cassette, wall-mounted, hide-away and Ceiling units
- Improves efficiency
- Better comfort
- Can be installed in the best location within the room for detection purposes

Sensor location image.

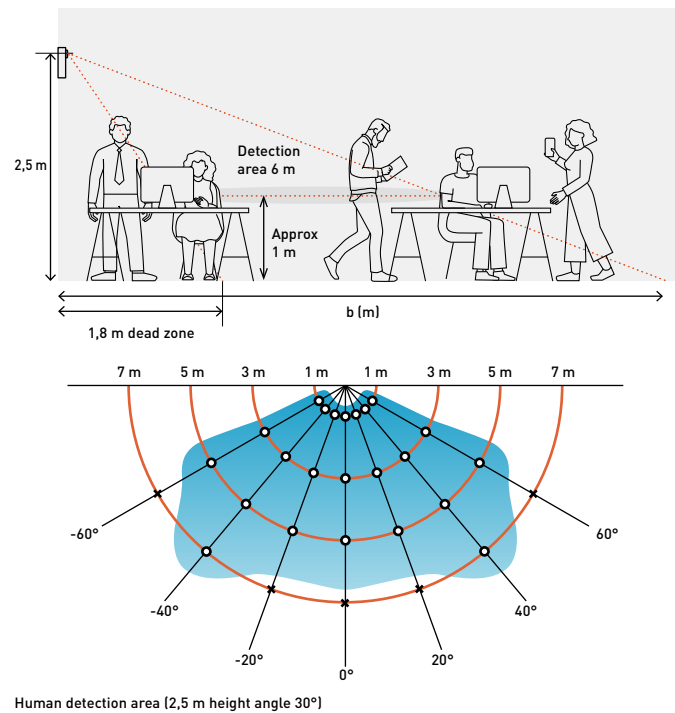

Providing outstanding energy saving performance, Panasonic's Inverter system can be connected to Econavi to detect when energy is being wasted. Econavi senses the presence or absence of people and the level of activity in each area of an office. When unnecessary heating or cooling is detected, indoor units are individually controlled to match office conditions for energy saving operation.

Detection of the level of activity enables precise power saving.

Presence or absence of people at their desks and the level of activity in the office are detected in real time. Set temperature is automatically adjusted to optimise the lower power consumption.

Remote Econavi sensor allows optimum energy operation.

Pillars, walls, cabinets and other fittings obstruct the sensor, reducing the area of detection and lowering the energy saving effect. Taking into consideration blind spots, Panasonic enables the optimum layout for sensors in any office.



Econavi sensor: CZ-CENSC1

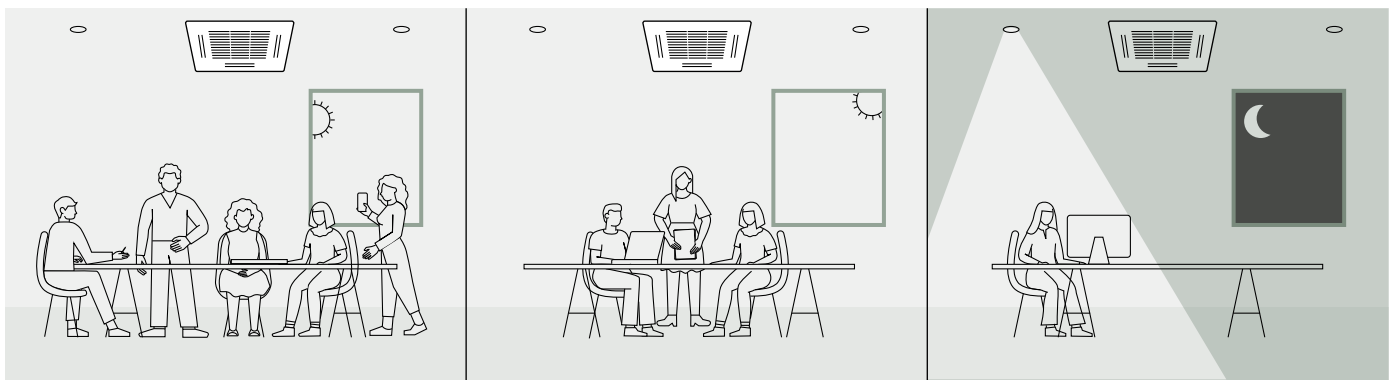

In the morning.
Thorough cooling when there is a high level of activity

In the afternoon.
Reduced cooling when there are fewer people

At night.
Automatic Thermo OFF depending on conditions at the end of the day

Controller for hotel application

Innovative line up of room controllers specially designed for hotel applications. With a modern cosmetic that match room interiors and simple operation for hotel guests.

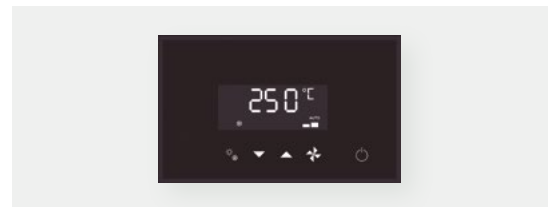
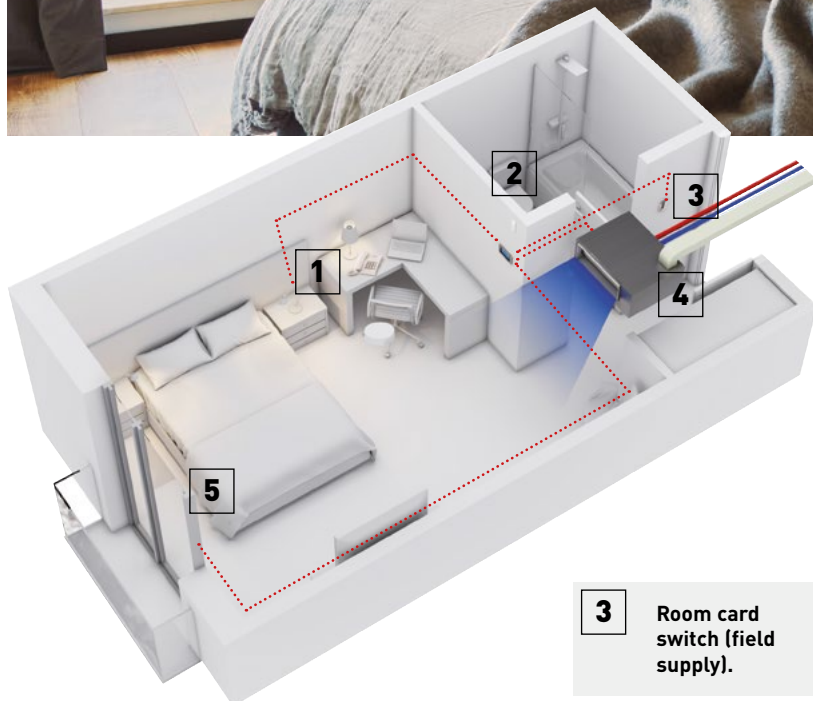

3 Room card switch (field supply).

Controller to integrate all room hotel needs in one device.

Card switch. Heating and cooling control. Light control. Window control. Possible to connect to Modbus.



Lighting control.



Wall sensor
PAW-WMS-AC (-DC).



Indoor unit. Variable static pressure hide-away.



Window contact
PAW-DWC.

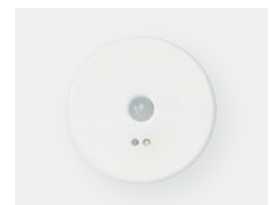

Ceiling motion sensor
PAW-CMS-AC (-DC).

- Easy to install
- Cost effective installation as all electrical cables are centralized on the remote: The lighting, card contact, motion detector, window contact and the air conditioning are controlled
- Architect inspired attractive design with 2 colors: black or white
- Stand alone and Modbus
- Bespoke finish by special order

Energy saving functions included on the device.

Turns OFF air conditioning and lighting when room is unoccupied. Disables air conditioning when window is open. Configurable maximum/minimum setpoint temperature.

Easy remote controller.

The hotel guest will have access to limited functions to control the air conditioning: ON / OFF, Temperature and Fan speed.

Easy set up.

Stand alone model with easy configuration menu to access all parameters. A pre-define scenario can be uploaded on the remote controller connected to a computer to make installation on site Plug & Play (only on the Modbus models).

NFC fast set up.

With the touch display control and touch room controller setting are quicker than ever. Just touching smartphone with NFC capability the settings will be saved. This function is also possible even when the control is not wired. Giving flexibility to save the setting even before installation.

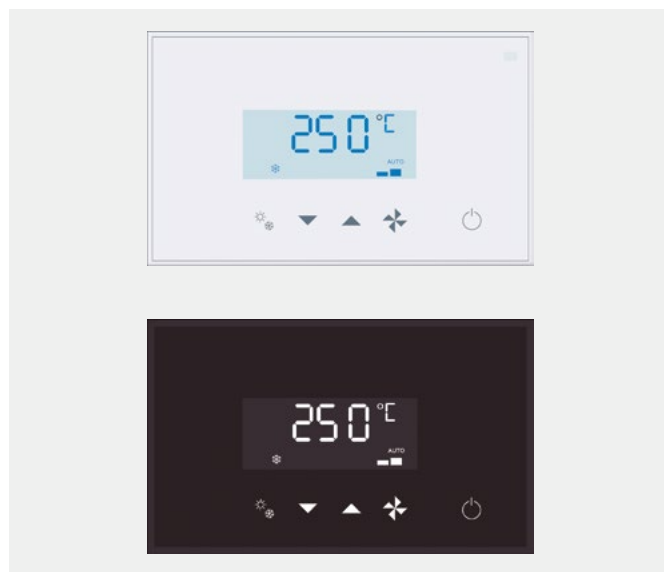

Type	Model	Colors	Digital inputs	Digital output	BMS	Inst. set up	T. sensor
Touch display controller	PAW-RE2D4-WH	White	2			NFC	Built-in
	PAW-RE2D4-BK	Black	2			NFC	Built-in
Touch room controller	PAW-RE2C4-MOD-WH	White	4	4	Modbus	NFC	Built-in
	PAW-RE2C4-MOD-BK	Black	4	4	Modbus	NFC	Built-in

Room controller: 4 digital inputs and 4 digital output

Room controller offers flexibility and easy installation thanks to 4 preconfigured options. This is available in Modbus type. Modbus references: PAW-RE2C4-MOD-WH, PAW-RE2C4-MOD-BK.

Wiring configuration example for option 2 in Modbus type.

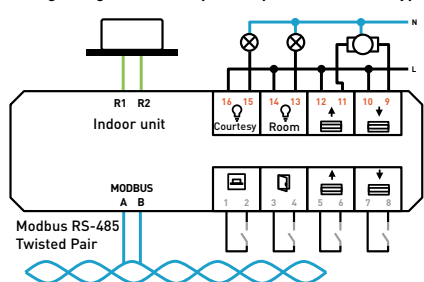

Configurations	4 options available I/O configurations: Inputs				Available I/O Configurations: Outputs			
	Digital 1-2	Digital 3-4	Digital 5-6	Analog 7-8	Relay 15-16	Relay 13-14	Relay 11-12	Relay 9-10
Option 1	Card	Window	Lighting	Temperature	Courtesy	Lighting	Not used	Valve actuator
Option 2	Card	Window	Blinds up	Blinds down	Courtesy	Lighting	Blinds up	Blinds down
Option 3	Motion sensor	Window	Door contact	Temperature	Courtesy	Lighting	Not used	Valve actuator
Option 4	Lighting	Window	Blinds up	Blinds down	Not used	Lighting	Blinds up	Blinds down

Display: 2 digital inputs

Display control allows to handle 2 inputs to perform most common operation in room hotels. References: PAW-RE2D4-WH, PAW-RE2D4-BK.

Wiring example for display controller.

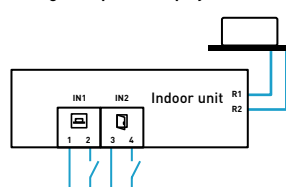

Configurations	3 options available: Inputs	
	IN1 [1-2]	IN2 [3-4]
Option 1	Card	Window
Option 2	Motion sensor	Window
Option 3	Motion sensor	Door contact

Hotel room controller	
PAW-RE2C4-MOD-WH	Modbus RS-485 touch room controller with I/O, white
PAW-RE2C4-MOD-BK	Modbus RS-485 touch room controller with I/O, black
PAW-RE2D4-WH	Touch display control with 2 digital inputs, white
PAW-RE2D4-BK	Touch display control with 2 digital inputs, black

Accessories sensors	
PAW-WMS-DC	Wall silent motion sensor 24 V
PAW-WMS-AC	Wall silent motion sensor 240 V AC
PAW-CMS-DC	Ceiling silent motion sensor 24 V
PAW-CMS-AC	Ceiling silent motion sensor 240 V AC
PAW-24DC	Power supply 24 V
PAW-DWC	Door or window contact

BMS interface with S-Link

BMS interface with Panasonic communication bus helps you to get significant savings.

In addition to reducing the time of configuration and installation, the potential mistakes can be avoided.

Easy to use and reliable interfaces for a straightforward integration.





Modbus®

Home automation



1 Direct connection to S-Communication bus

- No need for additional gateway (CZ-CFUNC2)
- Significant 50% cost saving for BMS interface*
- Avoid mistakes and reduce configuration time.

* In the case of PAW-AC2-BAC-16P by Panasonic calculation.

2 Easy configuration

- Single configuration tool for all models (Intesis MAPS)
- Firmware updates with improvements and features
- Scan: Automatic identification of the units present in the VRF system
- Front cover LED indicators provide easy to check communication status.

3 Upgraded specifications

- Outdoor unit's signal available for the integration
- BACnet: Version 14 and BTL Certified
- Datalogging through external USB port (for service)

Direct connection to S-Communication bus

The interface can provide faster, cheaper, easier solution in your projects!

Old interface.

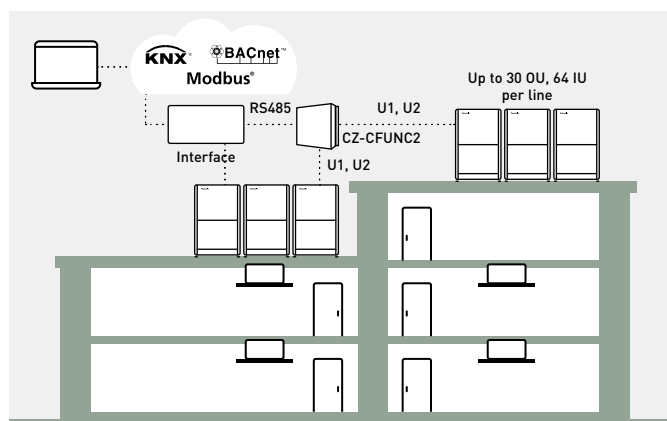

Maximum 128 indoor units can be connected. Panasonic Gateway, CZ-CFUNC2 is required.

Interface with S-Communication bus.

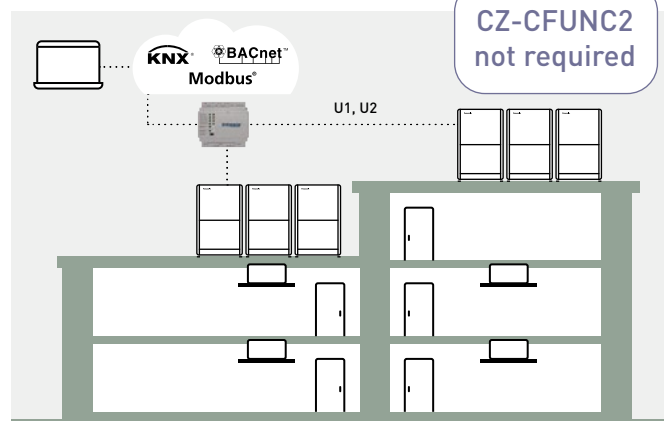

U1U2 link is connected directly to IntesisBox. Support from 16 to 128 per each box.

Home automation compatibility for Smart Home systems for PAW-AC2-MBS

Drivers available for:

- AMX
- Control4
- eedomus
- Elan
- Fibaro
- iRidium
- Eedom
- RTI
- Savant

Creston, Kuju and Vera available soon.

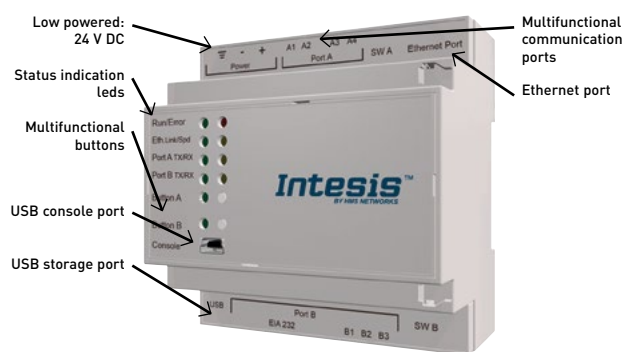

Model for BACnet	Maximum number of indoor units connected
PAW-AC2-BAC-16P	16 indoor units
PAW-AC2-BAC-64P	64 indoor units
PAW-AC2-BAC-128P	128 indoor units
Model for Modbus	Maximum number of indoor units connected
PAW-AC2-MBS-16P	16 indoor units
PAW-AC2-MBS-64P	64 indoor units
PAW-AC2-MBS-128P	128 indoor units
Model for KNX	Maximum number of indoor units connected
PAW-AC2-KNX-16P	16 indoor units
PAW-AC2-KNX-64P	64 indoor units

Version	Connectable indoor units	Connectable outdoor units	Nr. of P- Communication bus port
16	1-16	1-16	1
64	1-64	1-30	1
128	128 (1-64 / P- Communication bus port)	60 (1-30 / P- Communication bus port)	2





Control and connectivity

A wide variety of control options to meet the requirements of different applications.

Centralized control systems

<p>Centralised control.</p>  <p>P-AIMS core software. Up to 1024 indoor units. CZ-CSWKC2</p>	<p>Intelligent controller.</p>  <p>Intelligent controller. Up to 256 indoor units touch screen with web server. CZ-256ESMC3</p>	<p>Panasonic AC Smart Cloud.</p>  <p>Cloud internet control. Up to 128 groups. Controls 128 units. CZ-CFUSCC1</p>
---	--	--

Connection with general equipment.

 <p>ON / OFF control for external devices such as ERV. Controls 1 unit. CZ-CAPC3</p>	 <p>Demand control for Mini ECOi and PACi outdoor units. Up to 4 outdoor units. CZ-CAPDC3</p>	 <p>Mini Seri-Para I/O Unit 0 - 10 V. Controls 1 indoor unit or a group of 8 indoor units. CZ-CAPBC2</p>	 <p>Communication Adaptor. Up to 128 groups. Controls 128 units. CZ-CFUNC2</p>
--	---	---	--

Domestic integration to S-Link - CZ-CAPRA1

Can connect RAC range to S-Link. Full control is now possible.

Integrates any unit in big system control.

- YKEA server room integration ¹⁾
- Small offices with domestic indoors
- Tender for refurbishment (old system Domestic and VRF in one installation)

1) When duty rotation using the remote controller is set up, CZ-CAPRA1 cannot be connected.

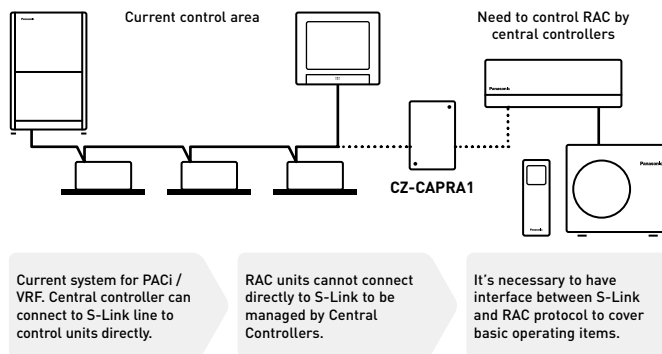

<p>Centralized Control Systems: 64 indoor units</p> 	<p>Intelligent controller / Web Server: 256 indoor units</p> 	<p>Panasonic AC Smart Cloud</p> 
---	---	--

Basic operation items: ON / OFF, Mode select, Temperature setting, Fan speed, Flap setting, Remote control prohibit.

External input: ON / OFF control signal, Abnormal stop signal.

External output for Relay ¹⁾: Operation status (ON / OFF), Alarm status output.







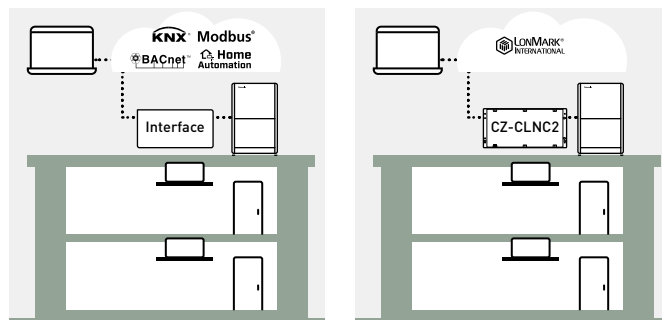

1) Because current CN-CNT connector can not provide the power for external output relay, additional 12 V DC power supply for external relay is necessary.

Easy connection to KNX, Modbus, Lonworks, BACnet and Proprietary Home Automation Systems

Easy and reliable solution to integrate your Panasonic heating and cooling systems into any B.M.S or E.M.S. Fully bi-directional communications with all necessary parameters.

For more information, contact Panasonic.



			Econavi control	Built-in thermostat	Indoor units which can be controlled	Use limitations	Function ON / OFF	Mode setting	Fan speed setting	Temperature setting	Air flow direction	Permit/Prohibit switching	Weekly program	BMS protocol
Individual controllers														
Touch room controller for hotel with Dry Contact and Modbus		PAW-RE2C4-MOD-WH PAW-RE2C4-MOD-BK WH: White, BK: Black. Bespoke finish available on request.	—	✓	1 indoor unit	—	✓	✓	✓	✓	—	✓	—	Modbus + 4 digital I/O signals
Touch display control for hotel with Dry Contacts		PAW-RE2D4-WH PAW-RE2D4-BK WH: White, BK: Black. Bespoke finish available on request.	—	✓	1 indoor unit	—	✓	✓	✓	✓	—	✓	—	Stand Alone + 2 digital inputs
Design wired remote controller		CZ-RTC5B	✓	✓	1 group, 8 units	· Up to 2 controllers can be connected per group	✓	✓	✓	✓	✓	—	✓	—
Wired remote controller		CZ-RTC6W CZ-RTC6 Non-wireless	✓	✓	1 group, 8 units	· Up to 2 controllers can be connected per group	✓	✓	✓	✓	✓	—	—	—
		CZ-RTC6WBL CZ-RTC6BL With Bluetooth®	✓	✓	1 group, 8 units	· Up to 1 controller can be connected per group	✓	✓	✓	✓	✓	—	✓	—
		CZ-RTC6WBLW CZ-RTC6BLW With Wi-Fi and Bluetooth®	✓	✓	1 group, 8 units	· Up to 1 controller can be connected per group	✓	✓	✓	✓	✓	—	✓	—
Infrared remote controller		CZ-RWS3 + CZ-RWRU3W CZ-RWS3 + CZ-RWRY3 CZ-RWS3 CZ-RWS3 + CZ-RWRL3 CZ-RWS3 + CZ-RWRD3 CZ-RWS3 + CZ-RWRT3 CZ-RWS3 + CZ-RWRC3	✓	—	1 group, 8 units	· Up to 2 controllers can be connected per group	✓	✓	✓	✓	✓ ¹⁾	—	—	—
Centralized controllers														
System controller with weekly timer		CZ-64ESMC3	✓	—	64 groups, maximum 64 units	· Up to 10 controllers, can be connected to one system · Main unit/sub unit (1 main unit + 1 sub unit) connection is possible · Use without remote controller is possible	✓	✓	✓	✓	✓ ¹⁾	✓	✓	—
Central ON / OFF controller		CZ-ANC3	—	—	16 groups, maximum 64 units	· Up to 8 controllers (4 main units + 4 sub units) can be connected to one system · Use without remote controller is impossible	✓	—	—	—	—	✓	—	—
Intelligent controller (touch screen/web server)		CZ-256ESMC3	✓	—	Main unit: 128. Up to 256 units can be expanded	· Communication adaptor CZ-CFUNC2 is necessary for connection with more than 128 units	✓	✓	✓	✓	✓ ¹⁾	✓	✓	—

1. Setting is not possible when a remote controller unit is present (use the remote controller for setting). * All specifications subject to change without notice.

Individual controllers wired

CONEX wired remote controller

CZ-RTC6W // CZ-RTC6 // CZ-RTC6WBL // CZ-RTC6BL // CZ-RTC6WBLW // CZ-RTC6BLW ¹⁾

- 3 line-up: - CZ-RTC6W // CZ-RTC6: Non-wireless
 - CZ-RTC6WBL // CZ-RTC6BL: Bluetooth®
 - CZ-RTC6WBLW // CZ-RTC6BLW: Wi-Fi and Bluetooth®
- Colours: 6W: White. 6: Black
- Intuitive control with stylish design profile
- Clean face with full flat and LCD display
- Dimension (HxWxD): 86 x 86 x 25 mm

Panasonic H&C Control App ²⁾.

- Daily remote control operation via Bluetooth®
- Quick and easy App set-up for system setting

Panasonic H&C Diagnosis App ³⁾.

- Easy access to service parameters and service checker data via Bluetooth®

Panasonic Comfort Cloud App

- Especially designed for end users
- Remote operation via Wi-Fi

Basic operation.

- Mode setting: Heat / Cool / Dry / Fan / Auto
- Temperature setting
- Fan speed: 5 levels
- Air flow direction
- nanoe™ X and Econavi setting
- Weekly program ⁴⁾

1) Compatible with PACi NX Series.

2) CZ-RTC6WBL, CZ-RTC6BL, CZ-RTC6WBLW or CZ-RTC6BLW required.

3) A service checker interface is required. Compatible with PACi NX Series.

4) Can be set from Panasonic H&C Control App.

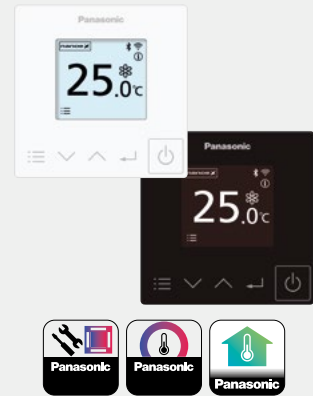

Room controller for hotel rooms

PAW-RE2C4-MOD-WH // PAW-RE2C4-MOD-BK

- Easy to install
- Cost effective installation as all electrical cables are centralised on this remote
- Architect inspired attractive design
- Direct connection to the Indoor unit with all primary functions of indoor unit available
- 2 options available: Stand alone and Modbus communication
- Colours: WH: White. BK: Black
- Room controller: 4 digital inputs and 4 digital outputs

From this remote controller.

The lighting, card contact, motion detector, window contact and the air conditioning are controlled.

Energy saving functions included on the device.

- Turns OFF air conditioning and lighting when room is unoccupied
- Disables air conditioning when window is open
- Maximum/minimum setpoint temperature configurable

Fast and simple set up.

Set up is simple and easy for room controllers. It is extremely easy and quick with touch models, which can be set up by using smartphone with NFC technology, even when control is not yet installed / powered.

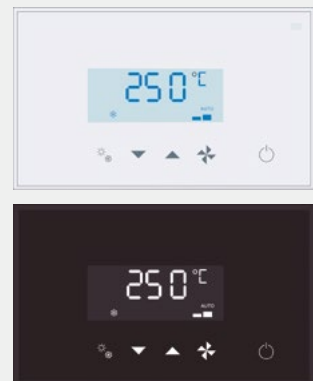

Display control for hotel rooms

PAW-RE2D4-WH // PAW-RE2D4-BK

- Easy to install
- Cost effective installation as all electrical cables are centralised on this remote
- Architect inspired attractive design
- Direct connection to the Indoor unit with all primary functions of indoor unit available
- Stand alone communication
- Colours: WH: White. BK: Black
- Basic hotel function: 2 digital inputs

From this remote controller.

The card contact, motion detector, window contact and the air conditioning are controlled.

Energy saving functions included on the device.

- Disables air conditioning when window is open
- Maximum/minimum setpoint temperature configurable

Fast and simple set up.

Set up with smartphone with NFC technology, even when control is not yet installed/powered.

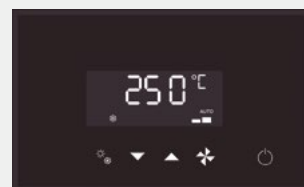
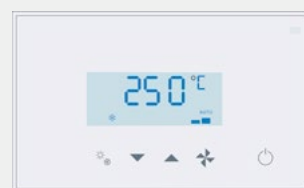

Design wired remote controller

CZ-RTC5B

- Power consumption monitor (only for PACi)
- Flat face design and touch sensor switch for stylish design and operating usability
- Functions such as for energy saving and monitoring and for service use are available on the full dot LCD (3,5" display)
- Improved illumination
- White LED backlit
- Blink when alarm occurs

Datanavi.

- Scan and save AC system info
- Easy access to manual database
- Commissioning, F-Gas check data history

* Panasonic App is required on your smartphone.

Basic Operation.

- Operation
- Mode
- Temperature setting
- Air flow volume
- Air flow direction

Timer function.

- Outing function
- Weekly program timer
- Easy ON / OFF timer
- Time display

Energy saving.

- Outing function
- Temperature setting range limitation
- Temperature auto return
- OFF remind
- Schedule demand control
- Energy saving mode
- Energy monitoring

Others.

- Key lock
- Ventilation fan control
- Display contrast adjustment
- Remote controller sensor
- Quiet operation mode
- Prohibit setting control from central controller
- Rotation / backup control



 datanavi

 nanoeX

 ECONAVI

* Power consumption monitoring is available for all PACi systems except R410A PACi Standard.

* Rotation and backup control with CZ-RTC5B is available for all PACi systems.

Individual wireless controllers

Infrared remote controller

CZ-RWS3 + CZ-RWRU3W // CZ-RWS3 + CZ-RWRY3 // CZ-RWS3 // CZ-RWS3 + CZ-RWRL3 // CZ-RWS3 + CZ-RWRD3 // CZ-RWS3 + CZ-RWRT3 // CZ-RWS3 + CZ-RWRC3

- Easy installation for the 4 Way Cassette type by simply replacing the corner part
- 24 hour timer function
- Remote controller by main remote controller and sub controller is possible (maximum 2 remote controllers (main remote controller and sub controller) can be installed for one indoor unit)
- When CZ-RWS3 is used, infrared control becomes possible for all indoor units (1: when a separate receiver is set up in a different room, control from that room also becomes possible. 2: automatic operation by means of the emergency operation button is possible even when the remote controller has been lost or the batteries have been exhausted)
- Operation of separate energy recovery ventilators (when commercial ventilation fans or heat-exchange ventilation fans have been installed, they can be operated with this remote controller (interlocked operation with the indoor unit or independent ventilation ON / OFF)

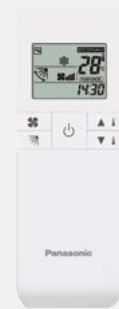

nanoeX
ECONAVI

Infrared remote controller and receiver for 4 way 90x90 cassette. CZ-RWS3 + CZ-RWRU3W



Infrared remote controller and receiver for 4 Way 60x60 cassette PY3 (with a panel). CZ-RWS3 + CZ-RWRY3



Infrared remote controller for wall-mounted, 4 way 60x60 with panel and floor console. CZ-RWS3



Infrared remote controller and receiver for 2 way cassette. CZ-RWS3 + CZ-RWRL3



Infrared remote controller and receiver for 1 way cassette. CZ-RWS3 + CZ-RWRD3



Infrared remote controller and receiver for ceiling. CZ-RWS3 + CZ-RWRT3



Infrared remote controller and receiver for all indoor units. CZ-RWS3 + CZ-RWRC3



Remote sensor

CZ-CSRC3

- This remote sensor can be connected to any PACi or VRF unit. Use it to detect the room temperature when no remote controller sensor or body sensor is used (connection to a system without a remote controller is possible)
- For joint use with a remote controller switch, use the remote controller switch as main remote controller
- Batch group control for up to 8 indoor units
- Appearance design based on simplified remote controller chassis
- Dimensions (HxWxD): 120 x 70 x 17 mm
- Weight: 70 g
- Temperature/Humidity range: 0 °C to 40 °C / 20% to 80% (no condensation) (indoor use only)
- Power supply: 16 V DC (supplied from indoor unit)
- Maximum number of connectable indoor units: Up to 8 units



Control contents	Part name, model No.	Quantity
Standard control <ul style="list-style-type: none"> · Control of the various operations of the indoor unit by wired or infrared remote controller · Cooling or heating mode of the outdoor unit is decided by the first priority of the remote controller · Switching between remote controller sensor and body sensor is possible 	High spec wired remote controller: CZ-RTC5B CONEX wired remote controller: CZ-RTC6W // CZ-RTC6 // CZ-RTC6WBL // CZ-RTC6BL // CZ-RTC6WBLW // CZ-RTC6BLW Infrared remote controller: CZ-RWS3 + CZ-RWRU3W // CZ-RWS3 + CZ-RWRY3 // CZ-RWS3 // CZ-RWS3 + CZ-RWRL3 // CZ-RWS3 + CZ-RWRD3 // CZ-RWS3 + CZ-RWRT3 // CZ-RWS3 + CZ-RWRC3	1 unit each
[1] Group control <ul style="list-style-type: none"> · Up to 8 units can be connected to 1 remote controller · Operation of all indoor units in the same mode 	High spec wired remote controller: CZ-RTC5B CONEX wired remote controller: CZ-RTC6W // CZ-RTC6 // CZ-RTC6WBL // CZ-RTC6BL // CZ-RTC6WBLW // CZ-RTC6BLW Infrared remote controller: CZ-RWS3 + CZ-RWRU3W // CZ-RWS3 + CZ-RWRY3 // CZ-RWS3 // CZ-RWS3 + CZ-RWRL3 // CZ-RWS3 + CZ-RWRD3 // CZ-RWS3 + CZ-RWRT3 // CZ-RWS3 + CZ-RWRC3	8 units
[2] Main/sub remote controller <ul style="list-style-type: none"> · Maximum 2 remote controllers per indoor unit · The button pressed last has priority · Timer setting is possible even with the sub remote controller 	Main or sub.: High spec wired remote controller: CZ-RTC5B CONEX wired remote controller: CZ-RTC6W // CZ-RTC6 // CZ-RTC6WBL // CZ-RTC6BL // CZ-RTC6WBLW // CZ-RTC6BLW Infrared remote controller: CZ-RWS3 + CZ-RWRU3W // CZ-RWS3 + CZ-RWRY3 // CZ-RWS3 // CZ-RWS3 + CZ-RWRL3 // CZ-RWS3 + CZ-RWRD3 // CZ-RWS3 + CZ-RWRT3 // CZ-RWS3 + CZ-RWRC3	As required

Centralised controllers

System controller with schedule timer

CZ-64ESMC3

Operation with various functions from central station.

Panasonic unveils state-of-the-art digital controller.

Panasonic's innovative and easy to use interface that offers full functionality with an integrated schedule timer and system controller, making managing heating and cooling systems easier than ever before. The CZ-64ESMC3 includes Panasonic's popular schedule timer, which gives users full flexibility over when they want their property heated or cooled. Users can adjust the system for holidays, pausing operations for long periods of time so that energy isn't wasted heating or cooling an empty home or office. The controller also allows six operations per day to be programmed.

Mix of current 2 controllers: System controller + schedule timer.

System controller will be designed by taking priority on these 2 operations with following technical key points:

- Same operation feeling as wired remote controller by touch-key panel
- High visibility and usability by full-dot LCD
- Based on high wired remote controller
- Maximum 64 group of indoor units, individual control for 64 units
- 4 zone control; 1 zone = maximum 16 groups
- Several energy saving function (based on CZ-RTC5B)
- 6 timer program per day for 1 week (7 days) operation (total 6 x 7 = 42 programs)
- Basic setting items (Temperature, Mode, Fan speed, Flap position) can be set by same manner as CZ-RTC5B

Function list:

Central control functions:

- Central control / individual setting
 - Start-stop prohibition for remote controller
 - Start-stop / Mode change / Temperature setting prohibition for remote controller
 - Mode change / Temperature setting prohibition for remote controller
 - Mode change prohibition for remote controller
 - Select items for prohibition
- Filter information
 - Filter sign
 - Filter sign reset
- Ventilation setting

Timer functions and external I/O:

- Weekly timer
 - Timer setting enable / disable
 - Copy of timer setting
- Maintenance
 - External signal (Start / Stop) (Demand control)
 - Centralized control master-slave setting
 - Alarm history
- Initial setting
 - Clock

Energy saving, maintenance and operating functions:

- Energy saving control
 - Econavi ON / OFF
- Filter information
 - Filter sign and hour counter display
- Maintenance
 - Service contact
- Initial setting
 - Clock display setting
 - Name Setting
 - Operation lock setting
 - Operation sound setting
 - LCD contrast setting
 - LCD backlight setting
 - Select displayed language (EN/FR/IT/ES/DE)
 - Administrator password
- Setting information list

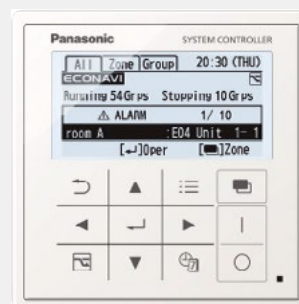

ECONAVI

Sample display image /
Operation status display

Operation Status ALL



Operation Status ZONE



Operation Status GROUP



ON / OFF controller

CZ-ANC3

Only ON / OFF operation from central station.

- 16 groups of indoor units can be controlled
- Collective control and individual group (unit) control can also be performed
- Up to 8 ON / OFF controller (4 main, 4 sub) can be installed in one link system
- The operation status can be determined immediately
- Dimensions (HxWxD): 121 x 122 x 14 + 52 mm (embedding dimension)

Power supply: 220 to 240 V AC.

I/O part: Remote input (effective voltage: within 24 V DC): ALL ON / OFF.

Remote output (allowable voltage: within 30 V DC): ON, Alarm.

Note: As operation mode and temperature settings are not possible with the ON / OFF controller, it must be used together with a remote controller, a system controller etc.

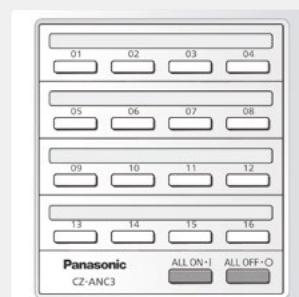

Centralised controllers

Intelligent controller (touch screen panel)

CZ-256ESMC3

Simplified load distribution ratio (LDR) for each tenant.

Dimensions (HxWxD): 240 x 280 x 20 (+60) mm.

Power supply: Single phase 100-240 V ~ 50/60 Hz.

Maximum number of connectable indoor units: 256 units (maximum per link: 64 units).

Maximum number of connectable outdoor units: 120 units (maximum per link: 30 units).

· Central control device: Up to 10 units

Enlarged display screen: 10,4 inch touch-panel colour LCD. Pursuing visibility, ease of use. Retrieve data from USB memory: Place the USB port inside the panel (USB memory available in stores).

Communication adaptor: CZ-CFUNC2*.

* CZ-CFUNC2 is required to connect more than 128 indoor units.

Functions:

- Graph display (trends, comparisons)
- Econavi ON / OFF
- Outdoor unit quiet operation ON / OFF
- Energy saving functions: Set temperature auto return settings, Auto shut OFF, Set temperature range limit settings, Energy saving for PAC current value, etc.
- Event control (such as equipment linkage)
- Performs closing at end of any period

Operation and status.

You can check to operational status (ON / OFF, operating mode, alarms, etc.) of all indoor units and outdoor units in real time. You can also select indoor units to change their settings.

Operation scheduling.

You can register daily operation schedules (ON / OFF time, operating modes, set temperatures, etc.) for individual indoor units or groups of indoor units. Operations can be schedule for up to 2 years in advance.

Load distribution calculation for each tenant.

- Air-conditioner load distribution ratio is calculated for each unit (tenant) with used energy consumption data (m³, kWh)
- Calculated data is stored as a CSV type file
- Data from the last 365 days is stored

Web application. Web access and control from remote station.

- Accessing from remote PC
- You can monitor/operate system by using web browser

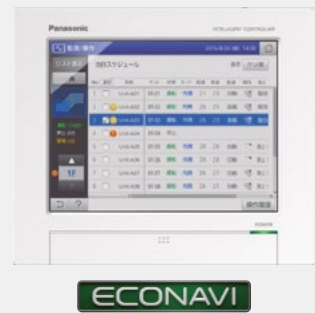

Remote controller.

The LAN terminal on this unit enables you connect it to a network. Connecting to Internet will enable you to operate the unit and check the status using a PC from a remote location*.

* Remote access rights and additional IT infrastructure / programming may be required.

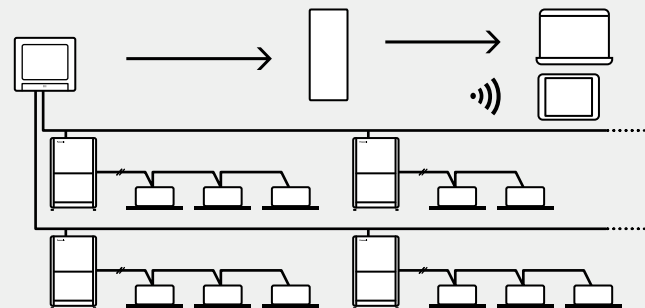

Backup tool to save your commissioning time.

Various data such as distribution, setting, log history etc. can be saved by CSV file.

Setting data of CSV file is available to edit and import to the controller again.

You can save time for commissioning and change setting flexibly and easily by your PC.

- Customize data
 - Data recovery
- Data can be imported again by general USB.

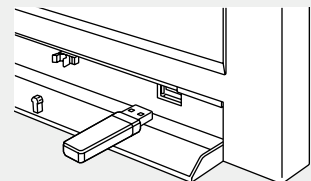

System configuration example.

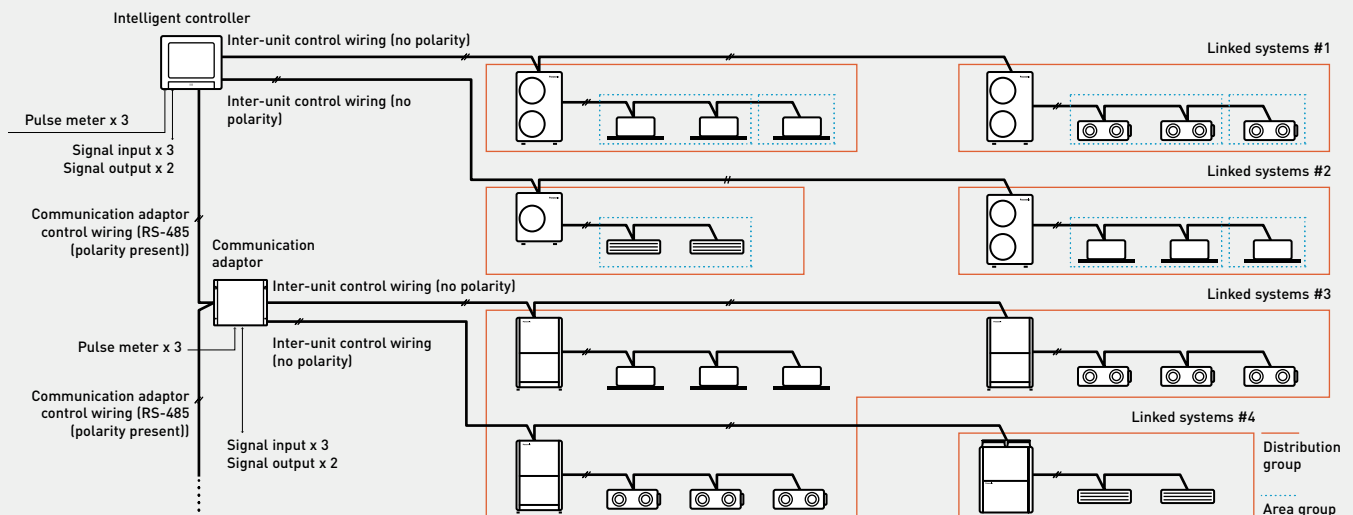

P-AIMS core software

CZ-CSWKC2 / P-AIMS core software.

Centralised software to control up to 1024 indoor units.



Functions of basic software.

- Standard remote controller for all indoor units.
- Many timer schedule programs can be set on the calendar.
- Detailed information display for alarms.
- CSV file output with alarm history, operating status.
- Automatic data backup to HDD.

P-AIMS is suitable for large shopping centers and universities with many areas/ buildings. 1 "P-AIMS" PC can have 4 independent systems at once.

Each system can have maximum 8 C/A units, and control maximum 512 units. In total, 1024 indoor units can be controlled by 1 "P-AIMS" PC.

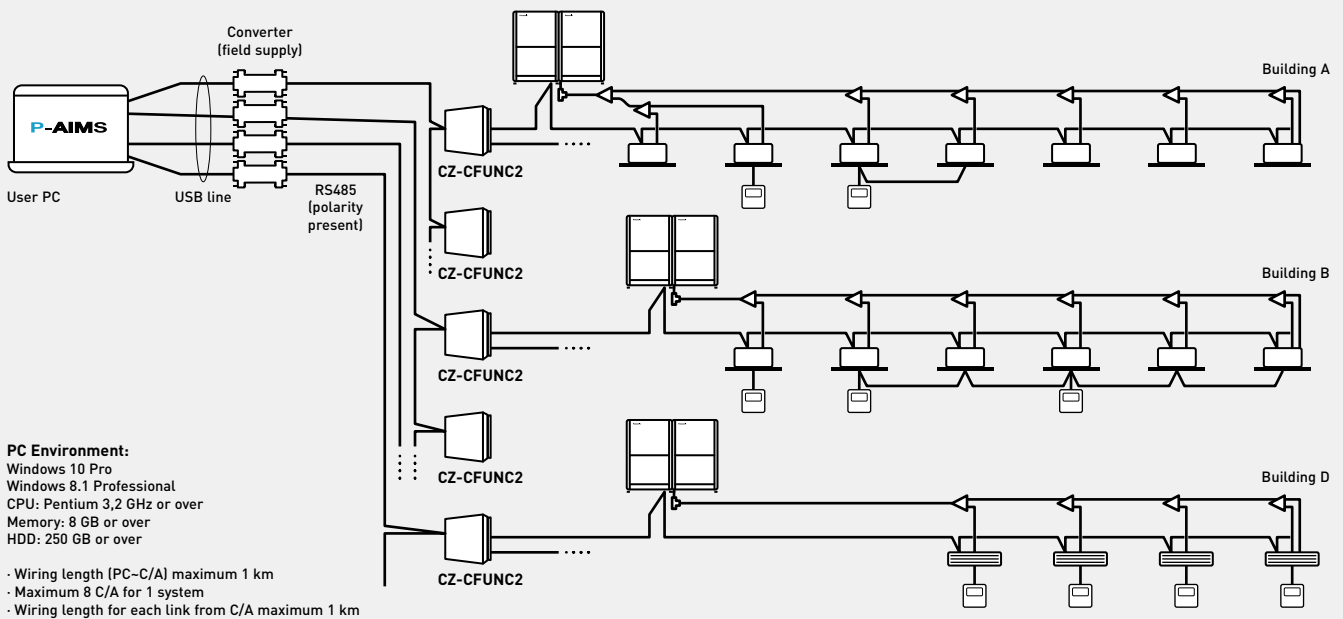

P-AIMS optional software CZ-CSWAC2 / P-AIMS consumption calculation extension.

- Air-conditioner load distribution ratio is calculated for each unit (tenant) with used energy consumption data (m³, kWh)
- Calculated data is stored as a CSV type file
- Data from the last 365 days is stored

P-AIMS optional software CZ-CSWWC2 / P-AIMS web application extension.

- Accessing P-AIMS software from remote PC
- You can monitor/operate ECOi System by using web browser (Internet Explorer)

P-AIMS optional software CZ-CSWGC2 / P-AIMS layout display extension.

- Operating status monitor is available on the layout display
- Object's layout and indoor unit's location can be checked at once
- Each unit can be controlled by virtual remote controller on the display
- Maximum 4 layout screens are shown at once

P-AIMS optional software CZ-CSWBC2 / P-AIMS BACnet extension.

- Can communicate with other equipment by BACnet protocol
- ECOi System can be controlled by both BMS and P-AIMS
- Maximum 255 indoor units can be connected to 1 PC (that has P-AIMS basic and BACnet software).



With 4 upgrade packages the basic software can be upgraded to suit individual requirements.

Centralised controllers

Local adaptor for ON / OFF control

CZ-CAPC3

Connection with general equipment.

- Control and status monitoring is possible for individual indoor unit (or any external electrical device up to 250 V AC, 10 A) by contact signal

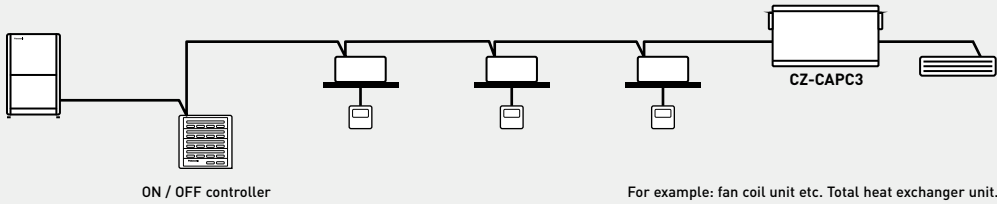

Demand control for Mini ECOi and PACi outdoor units

CZ-CAPDC3

Connection with general equipment.

- Control of both Mini ECOi and PACi units
- From the central control device, demand control and forced stop are possible

Input: Demand (non-voltage contact / 24 V DC / 2 mA, static signal).
 Input: Forced stop operation (non-voltage contact / 24 V DC / 10 mA, static signal).
 Forced stop input for fire alarm input control.
 3 step demand control for staged control of outdoor unit capacity.



Demand control.

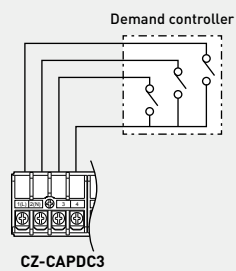

Forced stop.

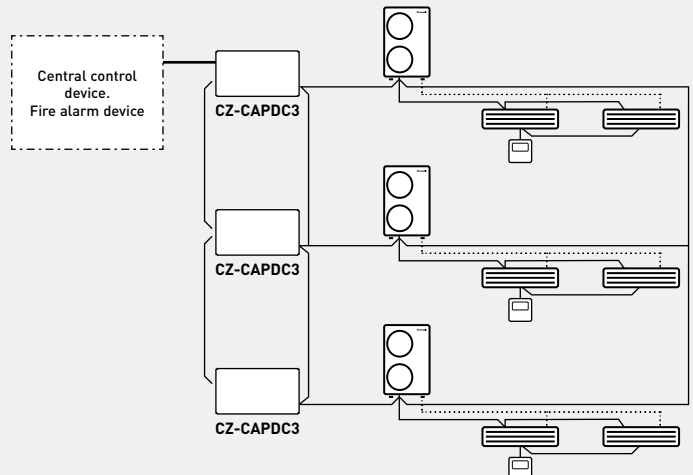
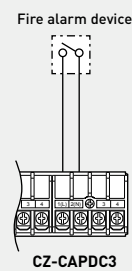

Mini Seri-Para I/O Unit 0 -10 V

CZ-CAPBC2

Connection with general equipment.

- Control and status monitoring is possible for individual indoor unit (1 group)
- In addition to operation and stop, there is a digital input function for air speed and operation mode
- Temperature setting and measuring of the indoor suction temperature can be performed from central monitoring
- Power is supplied from the T10 terminal of the indoor units
- The analog input for demand of the outdoor capacity by 20 steps (from 40% to 120%) by 0-10 V
- The analog input for temperature setting is 0 to 10 V, or 0 to 140 Ohm
- Separate power supply also is possible (in case of suction temperature measuring)

* Ask to your distributor.

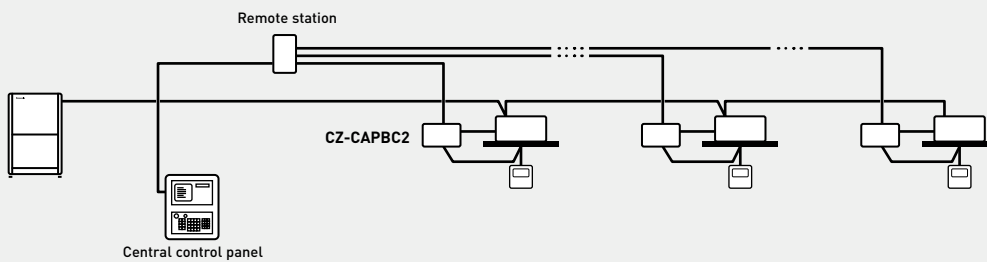

Communication adaptor for VRF connectivity

CZ-CFUNC2

This communication interface is required to connect a ECOi and GHP systems to a BMS. CZ-CFUNC2 is very easy to operate and to connect to the Panasonic S-Link, which is the ECOi bus. From the CZ-CFUNC2, all the indoor and outdoor units of the installation can be easily control. Two linked wiring systems can be connected to one CZ-CFUNC2.

Dimensions (H x W x D): 260 x 200 x 68 mm

* As this is not a splash-proof design, it must be installed indoors or in the control panel, etc.



PACi and VRF connectivity

Controls and connectivities are the key to offer better comfort and price. Panasonic offers its customers cutting-edge technology, specially designed to ensure our air conditioning systems deliver optimal performance.



PACi, ECOi and ECO G connectivity.

The interface has been designed specifically for Panasonic and provides complete monitoring, control and full functionality of the line-up from IntesisHome, KNX, Modbus, BACnet and LonWorks installations.

This connectivity solution with "PAW" model names is made by a third party company, please contact Panasonic for more information.

	Room controller	Interface	BMS Type	Maximum number of indoor units connected	
ECOi / PACi indoor units	SER8150R0B1194 / SER8150R5B1194		Modbus / BACnet	1 unit/group	
	PAW-RE2C4-MOD-WH / PAW-RE2C4-MOD-BK		Modbus	1 unit/group	
		PAW-RC2-KNX-1i	KNX	1 (1 group of indoor units)	
		PAW-RC2-MBS-1	Modbus RTU ¹⁾	1 (1 group of indoor units)	
		PAW-RC2-MBS-4	Modbus	4 Indoor/groups	
		PAW-RC2-BAC-1	BACnet	1	
		NEW PAW-AZRC-KNX-1	KNX	1 (1 group of indoor units)	
		NEW PAW-AZRC-MBS-1	Modbus RTU ¹⁾	1 (1 group of indoor units)	
		NEW PAW-AZRC-BAC-1	BACnet	1	
	PACi / ECOi / ECO G S-Link	PAW-AC2-KNX-16P		KNX	16
PAW-AC2-KNX-64P			KNX	64	
PAW-AC2-MBS-16P			Modbus	16	
PAW-AC2-MBS-64P			Modbus	64	
PAW-AC2-MBS-128P			Modbus	128	
PAW-AC2-BAC-16P			BACnet	16	
PAW-AC2-BAC-64P			BACnet	64	
PAW-AC2-BAC-128P			BACnet	128	
		CZ-CLNC2		LonWorks	16 groups of maximum 8 indoor units, in total maximum 64 indoor units

1) Interface Modbus RTU/TCP is needed in case if Modbus TCP connection. PAW-MBS-TCP2RTU (ModBus RTU Slave devices).

Airzone. Control of the hide-aways

Airzone has developed interfaces to easily connect to Panasonic Commercial hide-away units. Ensuring optimum performance, comfort and energy savings, the system is efficient and easy to install.

Airzone full range of accessories for any duct project.



Different type of outlets



Also plenum automatic doors



Full range of remote controls (wired / Infrared, ...)

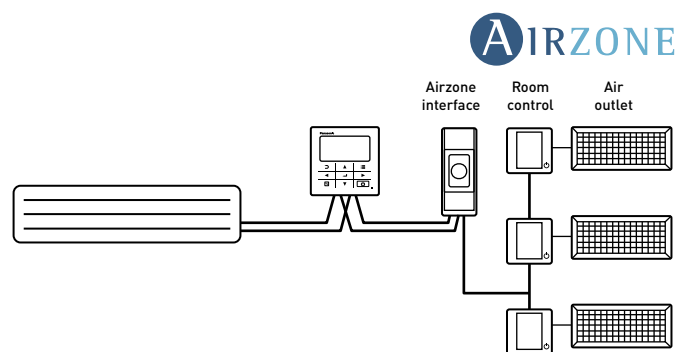

ECOi, ECO G and PACi connectivity indoor units

PCB's and cables for ECOi, ECO G and PACi indoor units.

Name of the cables	Function	Comment
CZ-T10	All T10 functions	Requires field supplied accessory
PAW-FDC	Operate external fan	Requires field supplied accessory
PAW-OCT	All option monitoring signals	Requires field supplied accessory
CZ-CAPE2	3-Pipe control PCB	Requires additional wires from spare part supply
PAW-EXCT	Forced Thermo OFF/Leakage D.	Requires field supplied accessory

Name of the PBC	Function	Comment
PAW-T10	All T10 functions	Allows easy connection "Plug & Play"
PAW-PACR4	PCB for server room application. Available for PACi, ECOi or ECO G.	Interface for redundant operation up to 4 indoor unit groups

T10 connector (CN061)

CZ-T10

Panasonic has developed an optional accessory (consisting of plug + wires) called CZ-T10 to enable an easy connection to this T10 connector.

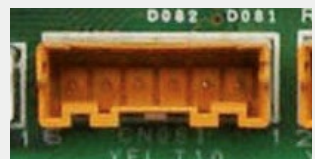

Connecting an ECOi indoor unit to an external device is easy. The T10 terminal featured in the electronic circuit board of all indoor units enables digital connection to external devices.

T10 terminal specification (T10: CN015 at indoor unit PCB).

- Control items: 1. Start / stop input
- 2. Remote controller prohibit input
- 3. Start signal output
- 4. Alarm signal output

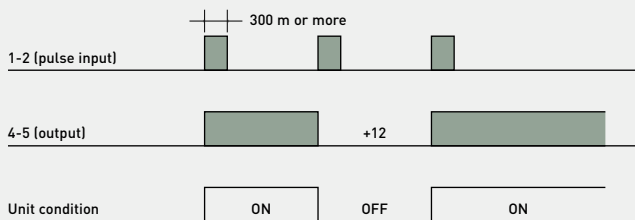

NOTE: The wire length from indoor unit to the relay must be within 2,0 m. Pulse signal changeable to static by cutting jumper JP001.

- Condition:
 - 1-2 (pulse input): Unit ON / OFF condition switching with a pulse signal. (1 pulse signal: shortage status more than 300 msec. or more)
 - 2-3 (static input): open / operation with remote is permitted (normal condition) close / remote controller is prohibited
 - 3-4 (static output): 12 V output during the unit ON / no output at OFF
 - 4-5 (static output): 12 V output when some errors occur / no output at normal

Example of wiring:

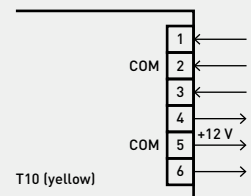

Usage example.

Forced OFF control.

Term 1 and 2: Free contact for ON / OFF signal (cut *JP1* for static signal) when the hotel card is it connected the contact must be close (the unit can be used).

Term 2 and 3: Free contact to prohibit all function in the remote controller install in the room when the hotel card is it removed the contact must be closed (the unit can not work).

Terminal = T10

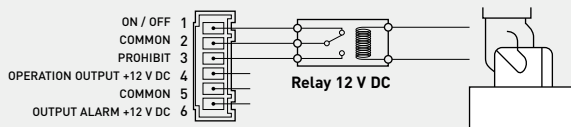

Operation ON / OFF signal output.

- Condition:
 - 4-5 (static output): 12 V output during the unit ON / no output at OFF

Example of wiring:

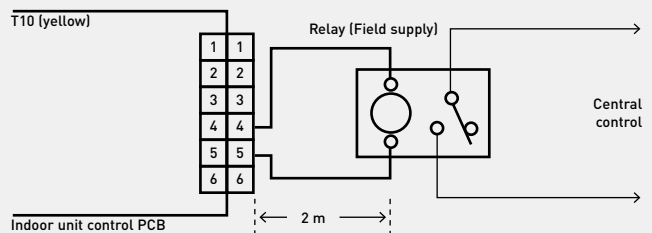

Note: The wire length from indoor unit to the Relay must be within 2,0 m. Pulse signal changeable to static by cutting jumper JP001.
* PACi-NX series is not compatible.

Fan drive connector (CN032)

PAW-FDC

Panasonic has developed an optional accessory (consisting of plug + wires) called PAW-FDC to enable an easy connection to this fan drive connector (CN032).

- Operating the ventilation fan from the remote controller
- Start / stop of external ventilation and total heat exchanger fans
- Works even if indoor unit is stopped
- In case of group control > all fans will operate; no individual control



External fan ON / OFF

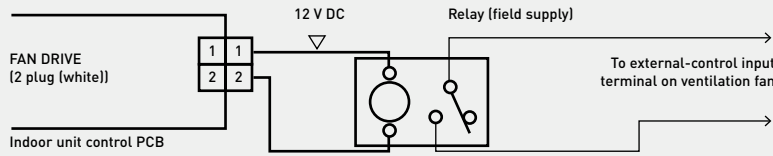

Option connector (CN060) output external signals

PAW-OCT

Panasonic has developed an optional accessory (consisting of plug + wires) called PAW-OCT to enable an easy connection to this Option Connector (CN060).

With the combination of the T10 and the option CN060 an external control of the indoor units is possible!

6P (white): Outputs external signals as shown in the figure below.

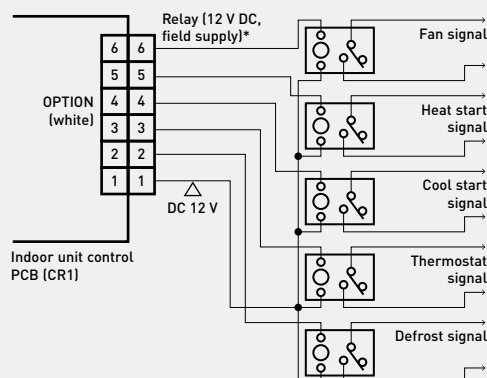

EXCT connector (CN009)

PAW-EXCT

Panasonic has developed an optional accessory (consisting of plug + wires) called PAW-EXCT to enable an easy connection to this EXCT Connector (CN009).

A) With static input.

> STATIC INPUT > THERMO OFF > ENERGY SAVING

2P plug (red): Can be used for demand control. When input is present, forces the unit to operate with the thermostat OFF.

Note: The length of the wiring from the indoor unit control PCB to the relay must be 2 m or less.

· Examples of wiring:

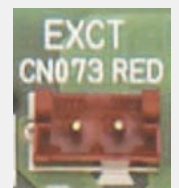
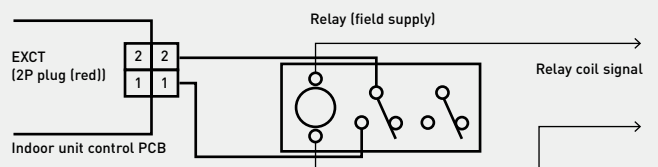

B) Example: In connection with a refrigerant sensor.

- Signal from leakage detector: non voltage, static.
- Indoor unit setting: Code 0b > 1
- Connector for leak detector: EXCT
- Outdoor unit setting: Code C1 > 1 power output if alarm from O2 connector 230 V Code C1 > 2 power output if alarm from O2 connector 0 V
- Displayed alarm message P14

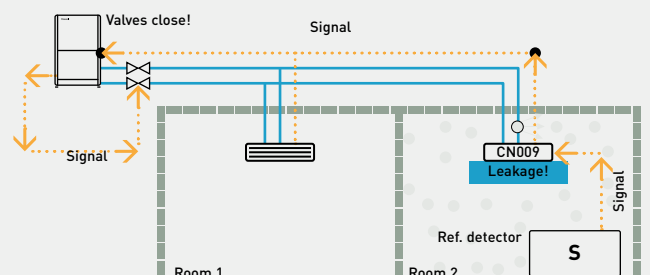

ECO i - W



Discover the ECOi-W.

Cooling only and heat pumps chillers

These ECOi-W Series provides a wide variety of HVAC system solutions, to meet all of your commercial and industrial needs.

ECOi-W meets the customer's needs → 414

Solutions for Hospitals → 416

ECOi-W R32 outdoor units

The range of sustainable chiller solutions to suit a variety of commercial and industrial applications → 418

Quality, efficiency and sustainability → 420

Range of ECOi-W R32 outdoor units → 422

U - 050/060/070/075 CQ, CR, CS → 424

U - 085/100/115/130 CQ, CR, CS → 426

U - 150/170 CQ, CR, CS → 428

U - 050/060/070/075 CM, CN, CO → 430

U - 085/100/115/130 CM, CN, CO → 432

U - 150/170 CM, CN, CO → 434

Options for R32 outdoor units → 436

ECOi-W R410A outdoor units

The solution for hotels, offices and industry → 438

Panasonic Certified Quality → 440

Range of ECOi-W R410A outdoor units → 442

U - 020/025/030/035/040 CV → 444

U - 140/150/170/190/210 CV → 446

U - 020/025/030/035/040 CW → 448

U - 140/150/170/190/210 CW → 450

Options for R410A outdoor units → 452

Fan coils → 454

Range of fan coils → 456

Fan coils - ducted → 458

Fan coils - high static pressure ducted → 460

Fan coils - 4 way cassette → 462

Fan coils - ceiling chassis → 464

Fan coils - floor-standing chassis → 466

Fan coils - wall-mounted → 468

Smart fan coils → 469

Control and connectivity → 470

Wired controllers for outdoor units → 470

Wired controllers for AC and EC fan coils → 471

Accessories and control → 472

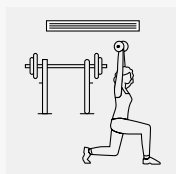
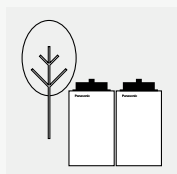

ECOi-W meets the customer's needs, with these fully customisable cooling only and heat pumps chillers

Unrivalled reliability and quality. Panasonic solutions can be enjoyed for years to come, even in the most extreme climates. Panasonic does not compromise on product quality, safety or durability, in order to provide the ultimate comfort when you need it most.



There is a reason to choose Panasonic as your partner.

ECO*i*-W

Panasonic does not compromise on product quality, always striving for 100% quality.
ECO*i*-W series offers smart technology meeting your needs at home and business.

Energy saving



Refrigerant gas R32.

Our heat pumps containing R32 refrigerant show a drastic reduction in the value of Global Warming Potential (GWP).



High seasonal efficiency in cooling mode.

SEER follows COMMISSION REGULATION (EU) No 2016/2281.

* U-020 R410A cooling only.



High seasonal efficiency in heating mode.

SCOP follows COMMISSION REGULATION (EU) No 813/2013.

* U-130 R32 heat pump.



EC motor green ventilation.

Range of fan coils with improved efficiency and optional EC fan motors.

High performance and indoor air quality



Super quiet.

Extra quiet operation is available as standard.



Bluefin.

Bluefin coil comes as standard on all heat pump models. The life time of coils have been extended and the defrost is optimised thanks to the hydrophilic coating.



Ultimate customisation.

A wide variety of options available, including pumps, hydraulic and ambient options. Ultimate customization for your needs and environment.



Automatic fan operation.

The microprocessor control automatically adjusts the fan speed as a function of the operating conditions.



Down to -17 °C in heating mode.

The ECO*i*-W system works in heating mode at outdoor temperature down to -17 °C*.

* Down to -15 °C with R32 models.



Up to 50 °C in cooling mode.

The ECO*i*-W system works in cooling mode at outdoor temperature up to 50 °C*.

* Up to 48 °C with R32 models.



Defrost limiting cycle (140 – 210).

Each pair of coils can be defrosted independently from the other pair of coils which are running in heating mode. This alternated defrost cycle ensures stable hot water even at low ambient conditions.

High connectivity



BMS connectivity. The communication port can be integrated into the ECO*i*-W system and provides easy connection and control. Modbus RTU is equipped as standard. Modbus TCP/IP, BACnet IP and BACnet MSTP available as standard with R32 models, and optionally available with R410A systems.

Reliable quality



Quality certified by Panasonic.

Panasonic does not compromise on product quality, safety, durability in order to provide the ultimate comfort when you need it most.



ECO*i*-W Series are compliant with ErP regulation.

SEER follows COMMISSION REGULATION (EU) No 2016/2281. SCOP follows COMMISSION REGULATION (EU) No 813/2013.



Eurovent certified performance.

The performance of ECO*i*-W Series has been certified by Eurovent to prove the high quality and high performance by Panasonic. <https://www.eurovent-certification.com/>

Support materials for customers

AutoCAD 2D files and BIM models for ECO*i*-W full range is readily available at Panasonic PROclub. <https://www.panasonicproclub.com>



Solutions for Hospitals

ECOi-W Series offers a reliable solution with an optimised design for service and maintenance, making it ideal for hospital applications. Remote monitoring through the ECOi-W Cloud offers enhanced service support and a highly efficient fan coil range delivers increased comfort.

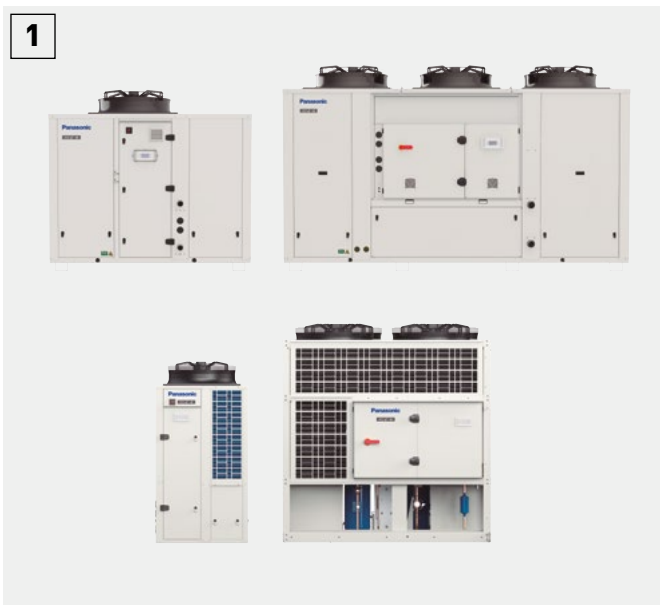

High quality heat pumps and cooling only chillers.

ECOi-W Series provides a fully customisable design to meet the business application needs, with a capacity range from 20 kW to 210 kW. Reliable quality and an optimised design for service and maintenance are ideal for hospital projects.



ECOi-W Cloud - remote monitoring.

This control provides remote access, in real time, to optimise service and maintenance work. It is a useful solution for a project requiring high levels of safety and non-stop operation, such as hospitals.



A wide variety of fan coils.

A wide variety of units to suit your needs, with flexible installation options. High efficiency and low noise operation allows for optimum comfort.

Operation in both heating and cooling is possible.

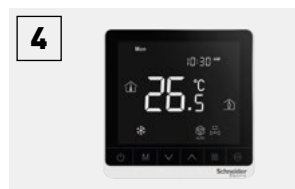

Intuitive controllers for fan coils.

Controllers with sophisticated designs provide a user friendly interface. An easy and low cost integration to building management systems.

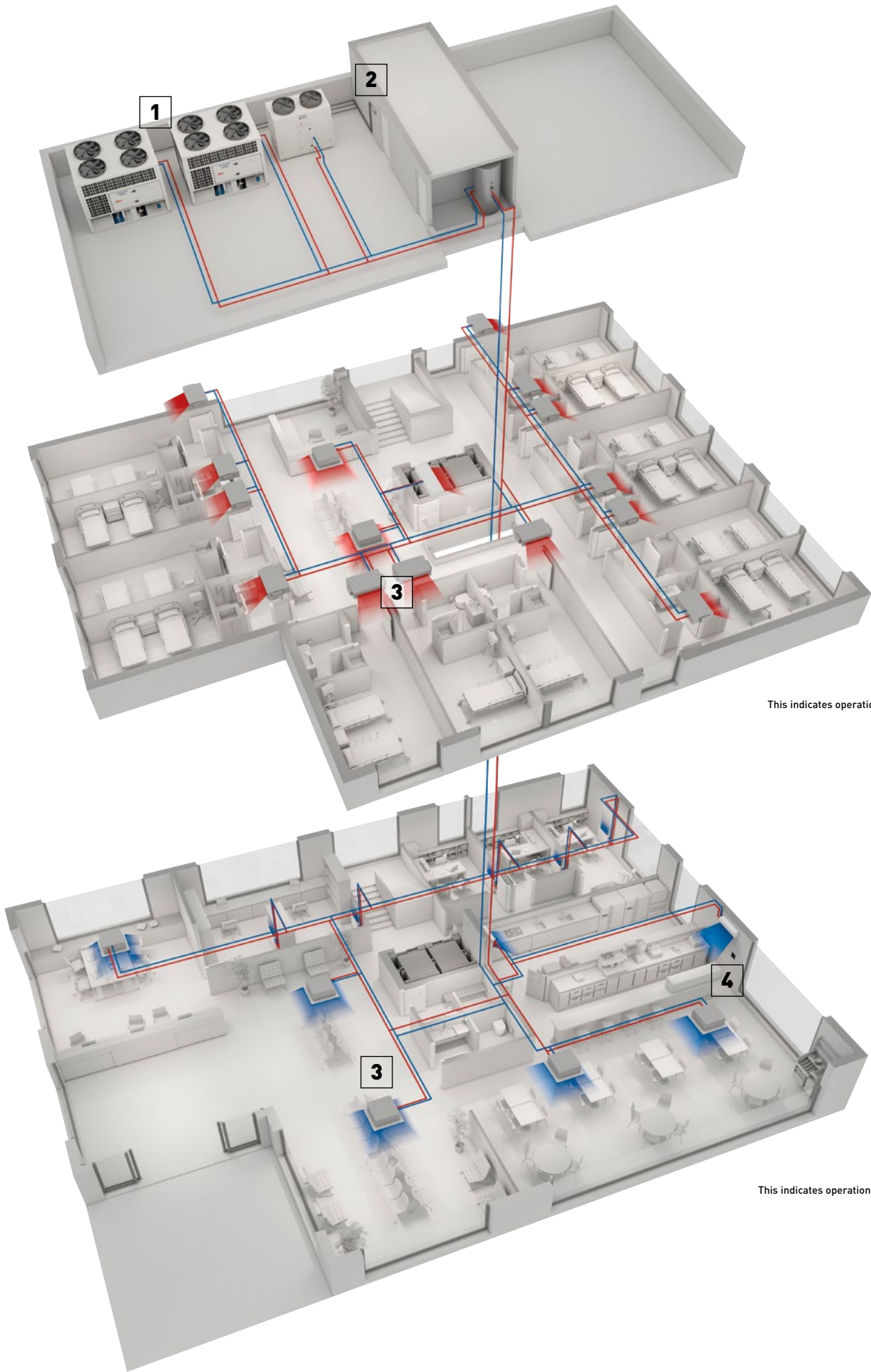

This indicates operation in winter.

This indicates operation in summer.

ECOi-W R32, the range of sustainable chiller solutions to suit a variety of commercial and industrial applications

ECOi-W provides the optimal performance in any climatic condition.



1 High efficiency level
 High efficiency levels thanks to optimised compressor performance, specially designed for R32 refrigerant.

2 R32 refrigerant
 Thanks to a GWP (Global Warming Potential) of 675, this refrigerant is 3 times less polluting than the standard R410A.

3 High flexibility

- Capacity range from 50 to 170 kW
- Customisable design
- Operating range: -15 °C (heating) to 48 °C (cooling)
- New Plug & Play control for ECOi-W cascade systems

4 High quality

- Defrost limiting coil design
- Optimised design for service and maintenance
- Compact footprint

Operating conditions

Panasonic ECOi-W provides a wide operating range from -15 °C in heating to 48 °C in cooling.

Water outlet temperature in cooling.
 A fluid outlet temperature of -10 °C in cooling offers uniqueness to the ECOi-W Series, which can ensure the operating temperature for process equipment in factories.

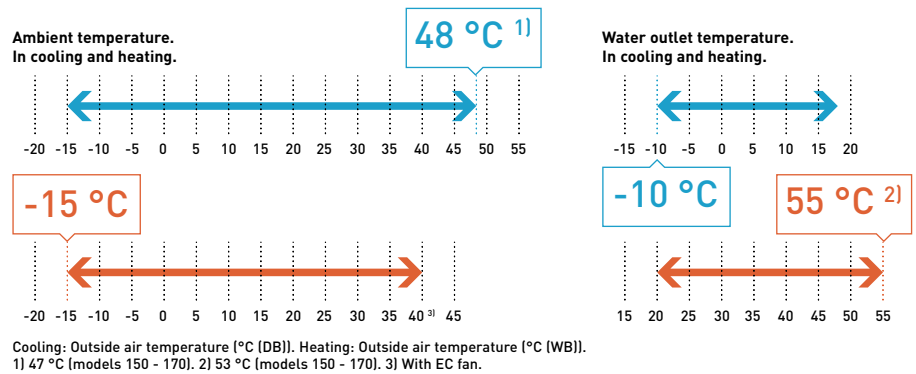

ECOi-W R32 line-up

ECOi-W R32 size		50	60	70	75	85	100	115	130	150	170
Cooling only range	Cooling capacities (kW)	52,6	60,4	70,0	75,3	84,2	102,0	121,0	135,0	156,0	176,0
	SEER	4,23	4,40	4,57	4,60	4,52	4,30	4,53	4,47	4,64	4,56
Heat pump range	Cooling capacities (kW)	49,9	60,4	70,0	75,3	84,2	102,0	121,0	135,0	156,0	176,0
	Heating capacities (kW)	53,5	61,5	71,7	80,0	86,2	105,0	123,0	137,0	158,0	182,0
	SEER ¹⁾	4,36	4,32	4,54	4,47	4,48	4,35	4,34	4,33	4,61	4,62
	SCOP ¹⁾	3,63	3,52	3,55	3,57	3,57	3,63	3,60	3,73	3,65	3,60
	Energy efficiency class (heating) ^{1) 2)}	A+	A+	A+	A+	—	—	—	—	—	—
	Dimension (HxWxD)										
		1986x2180x1160	1986x2180x1160	2286x2180x1160	2286x2180x1160	2286x2180x1160	2286x2180x1160	2286x2180x1160	2285 x 3789 x 1151	2285 x 3789 x 1151	2285 x 3789 x 1151

1) Those are the data with variable flow. 2) Following Eurovent and COMMISSION REGULATION (EU) No 811/2013 for low-temperature heat pumps. Scale from A+++ to D, as of 26th September 2019.

ECOi-W R32. Quality, efficiency and sustainability

Offering a highly efficient and environmentally friendly solution; the combination of a 3 times less polluting refrigerant along with a generation of outdoor heat exchangers helps to reduce the carbon footprint of each unit by 84% ¹⁾.

Better for your buildings, therefore better for the planet.



Key points

- 10 sizes - 4 chassis
- Cooling only or reversible units
- Low GWP R32 refrigerant
- High efficiency
- Wide operating limits
- Low footprint
- Advanced control system
- Easy maintenance
- Standard or super low noise versions
- Remotely controllable with ECOi-W Cloud
- 100% factory tested

Outstanding water pump configuration

Units can be equipped with a variable speed pump that automatically adjusts its speed according to the required capacity.

Compared to a fixed-speed pump, and depending on the operating profile of a pump working at partial load, the annual energy consumption of the pump can be reduced.

R32
675

R410A
2088



GWP - Measurement scale.

1) Comparison made between equivalent units operating respectively with R410A and R32 refrigerants. Impact only considers the refrigerants and not the units as a whole. 2) U-150 R32 cooling only. 3) U-130 R32 heat pump chiller.

Compact units.

The ECOi-W R32 range has been designed in a compact manner to ensure the smallest possible footprint. The first chassis measures 2,53 m² and the third chassis features **one of the smallest footprint on the market** with an average ratio of 37 kW/m².

Super low noise versions.

For the entire range, customers can choose between a standard unit or a super low noise version. The super low noise version features EC fans and compressor sound jackets for improved sound levels.



Advanced control system

The ECOi-W R32 units are equipped with a user-friendly external control panel that displays the operating parameters and alarms.



Optimised for EC fans control and electronic expansion valve management, the controller comes built-in with the following communication protocols: Modbus RTU, Modbus TCP/IP, BACnet MSTP, BACnet IP.

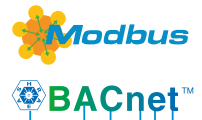

EC fans

For an even better efficiency level and improved acoustic performance, ECOi-W R32 units can be equipped with EC fans*.

* EC type high pressure fans also available.

Scroll compressors

The two scroll compressors are optimized for the R32 refrigerant and are covered with sound jackets in "super low noise" (S) versions.

Removable panels

Great accessibility to internal components for easy service operations.

Electronic expansion valve

This reliable and high-performance valve minimises overheating of the evaporator. It is directly managed from the control system.

Highly optimised external heat exchanger



Coil design enables a refrigerant charge reduction of 40%.

New cascade control

Plug & Play control for ECOi-W cascade systems is newly available. Cascade up to 8 outdoor units and ready to be integrated with ECOi-W Cloud.

* Compatible with R32 and R410A models.

Range of ECOi-W R32 outdoor units

Page	Outdoor units	50 kW	60 kW	70 kW	75 kW
	ECOi-W R32 50 to 60				
P. 424	Cooling only	U-050CQNB / U-050CQBM / U-050CRNB / U-050CRBM / U-050CSNB / U-050CSBM	U-060CQNB / U-060CQBM / U-060CRNB / U-060CRBM / U-060CSNB / U-060CSBM		
P. 430	Heat pump	U-050CMNB / U-050CMBM / U-050CNNB / U-050CNBM / U-050CONB / U-050COBM	U-060CMNB / U-060CMBM / U-060CNNB / U-060CNBM / U-060CONB / U-060COBM		
	ECOi-W R32 70 to 75				
P. 424	Cooling only		U-070CQNB / U-070CQBM / U-070CRNB / U-070CRBM / U-070CSNB / U-070CSBM	U-075CQNB / U-075CQBM / U-075CRNB / U-075CRBM / U-075CSNB / U-075CSBM	
P. 430	Heat pump		U-070CMNB / U-070CMBM / U-070CNNB / U-070CNBM / U-070CONB / U-070COBM	U-075CMNB / U-075CMBM / U-075CNNB / U-075CNBM / U-075CONB / U-075COBM	
	ECOi-W R32 85 to 130				
P. 426	Cooling only				
P. 432	Heat pump				
	ECOi-W R32 150 to 170				
P. 428	Cooling only				
P. 434	Heat pump				



85 kW

100 kW

115 kW

130 kW

150 kW

170 kW



U-085CQNB / U-085CQBL / U-085CRNB / U-085CRBL / U-085CSNB / U-085CSBL	U-100CQNB / U-100CQBL / U-100CRNB / U-100CRBL / U-100CSNB / U-100CSBL	U-115CQNB / U-115CQBL / U-115CRNB / U-115CRBL / U-115CSNB / U-115CSBL	U-130CQNB / U-130CQBL / U-130CRNB / U-130CRBL / U-130CSNB / U-130CSBL
---	---	---	---

U-085CMNB / U-085CMBL / U-085CNNB / U-085CNBL / U-085CONB / U-085COBL	U-100CMNB / U-100CMBL / U-100CNNB / U-100CNBL / U-100CONB / U-100COBL	U-115CMNB / U-115CMBL / U-115CNNB / U-115CNBL / U-115CONB / U-115COBL	U-130CMNB / U-130CMBL / U-130CNNB / U-130CNBL / U-130CONB / U-130COBL
---	---	---	---



U-150CQNB / U-150CQBL / U-150CRNB / U-150CRBL / U-150CSNB / U-150CSBL	U-170CQNB / U-170CQBL / U-170CRNB / U-170CRBL / U-170CSNB / U-170CSBL
---	---

U-150CMNB / U-150CMBL / U-150CNNB / U-150CNBL / U-150CONB / U-150COBL	U-170CMNB / U-170CMBL / U-170CNNB / U-170CNBL / U-170CONB / U-170COBL
---	---



U - 050/060/070/075 CQ, CR, CS

Cooling capacity: 52,6 to 75,3 kW

High seasonal efficiency and wide range options to meet the exact requirements of your project.



- High seasonal efficiency
- Ambient temperature operating range: -15 to +48 °C
- Water outlet temperature range: -10 to +18 °C
- Optional acoustically insulating compressor jacket
- Optimised design for service and maintenance
- Simple user friendly control as standard
- Modbus RTU & TCP/IP, BACnet MSTP & IP as standard
- Electronic expansion valve

Technical focus

- Chiller type: cooling only
- Compressor type (number): Scroll compressors (2)
- Refrigerant type: R32
- Refrigerant circuit: 1
- Fan type (number): axial fan (1 for 50/60, 2 for 70/75), optional EC and high pressure EC fans
- Heat exchanger: stainless steel plate heat exchanger
- Flow switch, water safety and air purge valves included
- Water filter included (mandatory to be installed on site)
- Night mode setting to save energy and reduce noise level
- Water compensation curve control

Ambient temperature.

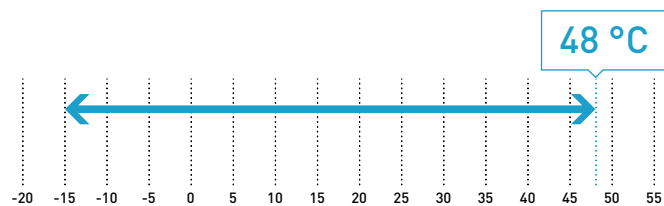

Cooling: Outside air temperature [°C (DB)].

Water outlet temperature.

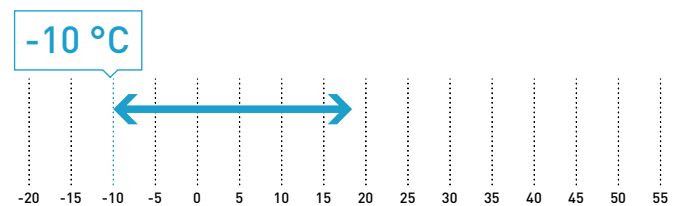

Available options

Options					
Pump	Pump drive	Hydraulic options	Ambient options	Control options	Electrical options
Single pump low pressure	Fixed speed	Low water pressure sensor ¹⁾	Finned coil treatment - epoxy	Digital input for: Cooling/heating or Night mode or Load Shedding	EC fan(s) option
Single pump high pressure	Variable twin speed (single pump)	Desuperheater	Finned coil Blygold treatment		Soft starter
Double pump low pressure	Variable twin speed (double pump)	Water isolation valves	Outdoor coil protection grid		Refrigerant options
Double pump high pressure	Constant outlet pressure (single pump) ²⁾		Rubber pads (supplied loose)		Refrigerant gauges (HP and LP manometers)
	Constant outlet pressure (double pump) ²⁾		Spring damper (supplied loose)		
			Container transport		
			Acoustically insulating compressor jacket		

1) Low water pressure sensor is supplied loose when selected as an option without pump and hydraulic kit. To be installed on site. 2) Available on special quotation, please contact your local sales representative.



REFER TO PAGE 436 TO SEE MORE OPTIONS FOR R32 OUTDOOR UNITS



Optional controller.
PAW-SYSREMKIT1



Optional Shut off valves
kit for model 50 - 75.
PAW-SYSSOV4

Model	50			60			70			75				
AC fan model w/o buffer / w buffer	U-050CQNB / U-050CQBM			U-060CQNB / U-060CQBM			U-070CQNB / U-070CQBM			U-075CQNB / U-075CQBM				
EC fan model w/o buffer / w buffer	U-050CRNB / U-050CRBM			U-060CRNB / U-060CRBM			U-070CRNB / U-070CRBM			U-075CRNB / U-075CRBM				
High pressure EC fan model w/o buffer / w buffer	U-050CSNB / U-050CSBM			U-060CSNB / U-060CSBM			U-070CSNB / U-070CSBM			U-075CSNB / U-075CSBM				
Power supply	Voltage	V			400			400			400			
	Phase	Three phase			Three phase			Three phase			Three phase			
	Frequency	Hz			50			50			50			
Cooling capacity ¹⁾	kW		52,6	60,4		70,0		75,3						
Input power ¹⁾	kW		16,8	19,8		22,3		25,7						
Total EER 100% ¹⁾			3,12	3,05		3,15		2,93						
SEER ²⁾	AC / EC	4,23 / 4,69		4,40 / 4,87		4,57 / 4,88		4,60 / 4,82						
η_{s,c} ²⁾	AC / EC	%		166 / 184		173 / 192		180 / 192		181 / 190				
Startup type	Direct			Direct			Direct			Direct				
Maximum operating current	A		43,3	52,7		60,0		69,4						
Startup current w/o / w softstarter	A		161 / 119	162 / 121		200 / 148		209 / 157						
Sound power (w AC/EC / HP EC fans)	dB(A)		83,2 / 87,2	83,8 / 87,3		81,3 / 89,2		81,3 / 89,3						
Sound pressure (w AC/EC / HP EC fans) ³⁾	dB(A)		51,4 / 55,4	52,0 / 55,5		49,5 / 57,4		49,5 / 57,5						
Dimension (w AC fans) w/o buffer	HxWxD	mm		1986 x 2180 x 1160		1986 x 2180 x 1160		1986 x 2180 x 1160		1986 x 2180 x 1160				
Dimension (w AC fans) w buffer	HxWxD	mm		1986 x 2680 x 1160		1986 x 2680 x 1160		1986 x 2680 x 1160		1986 x 2680 x 1160				
Dimension (w EC/HP EC fans) w/o buffer	HxWxD	mm		2034 x 2180 x 1160		2034 x 2180 x 1160		2034 x 2180 x 1160		2034 x 2180 x 1160				
Dimension (w EC/HP EC fans) w buffer	HxWxD	mm		2034 x 2680 x 1160		2034 x 2680 x 1160		2034 x 2680 x 1160		2034 x 2680 x 1160				
Operating weight w/o buffer / w buffer	kg		527 / 1018		547 / 1038		621 / 1114		637 / 1130					
Refrigerant (R32)	kg		7,9		8,1		10,3		10,6					
Number of refrigerant circuit	1			1			1			1				
Compressors														
Number	2			2			2			2				
Type	Scroll			Scroll			Scroll			Scroll				
Part load step	%		0 / 47 / 53 / 100		0 / 41 / 59 / 100		0 / 40 / 60 / 100		0 / 46 / 54 / 100					
Crankcase heater	W		70 / 70		70 / 66		70 / 66		66 / 66					
Evaporator														
Number	1			1			1			1				
Type	Plate			Plate			Plate			Plate				
Nominal water flow	Cool	m ³ /h		9,2		10,6		12,2		13,2				
Water pressure drop	Cool	kPa		35,4		46,8		33,1		38,2				
Water volume	l		4,1		4,1		6,1		6,1					
Antifreeze heater	W		30		30		2 x 30		2 x 30					
Coils														
Number	1			1			2			2				
Frontal surface	m ²		4,2		4,2		5,6		5,6					
Number of rows	2			2			2			2				
Fans standard														
Number	1			1			2			2				
Air flow	m ³ /h		21200	21200	21200	21200	21200	30000	30000	30000	30000	30000		
Rotation speed	r.p.m.		870	780	940	870	780	940	690	620	940	690	620	940
Input power (each fan)	kW		2,1	1,1	1,6	2,1	1,1	1,6	1,0	0,6	1,9	1,0	0,6	1,9
Static pressure (HP EC)	Pa		85		85		180		180					
Water connections														
Type	Male gas threaded BSPP ISO 228			Male gas threaded BSPP ISO 228			Male gas threaded BSPP ISO 228			Male gas threaded BSPP ISO 228				
Inlet - Outlet - diameter	Evaporator	Inch		2 - 2		2 - 2		2 - 2		2 - 2				
Inlet - Outlet - diameter	Desuperheater	Inch		1 ¼ - 1 ¼		1 ¼ - 1 ¼		1 ¼ - 1 ¼		1 ¼ - 1 ¼				

1) Data refers to 7 °C leaving chilled water temperature and 35 °C condenser air temperature, according EN14511 standard. 2) Following COMMISSION REGULATION (EU) No 2016/2281 for comfort application chillers. 3) Sound pressure levels calculated at 10 meters. Sound pressure levels refer to ISO standard 3744 with parallel piped shape.
* w: with, w/o: without. ** The data are calculated with variable flow.

Accessories	
PAW-SYSREMKIT1	Remote control
PAW-CM000SP041	Cloudgate Plug & Play IP65 box mobile 4G Europe
PAW-CM000K0001	Remote antenna to improve signal coverage

Accessories	
PAW-00SRTS011	ECOi-W Cloud service fee. Prepaid subscription for 1 year
PAW-SYSSOV4	Shut off valves kit for model 50 - 75





U - 085/100/115/130 CQ, CR, CS

Cooling capacity: 84,2 to 135,0 kW

Customizable design gives high flexibility. Wide range of communication protocols fulfill the requirements in hotels, offices, industry applications.



- High seasonal efficiency
- Ambient temperature operating range: -15 to +48 °C
- Water outlet temperature range: -10 to +18 °C
- Optional acoustically insulating compressor jacket
- Optimised design for service and maintenance
- Simple user friendly control as standard
- Modbus RTU & TCP/IP, BACnet MSTP & IP as standard
- Electronic expansion valve

Technical focus

- Chiller type: cooling only
- Compressor type (number): Scroll compressors (2)
- Refrigerant type: R32
- Refrigerant circuit: 1
- Fan type (number): axial fan (2), optional EC and high pressure EC fans
- Heat exchanger: stainless steel plate heat exchanger
- Flow switch, water safety and air purge valves included
- Water filter included (mandatory to be installed on site)
- Night mode setting to save energy and reduce noise level
- Water compensation curve control

Ambient temperature.

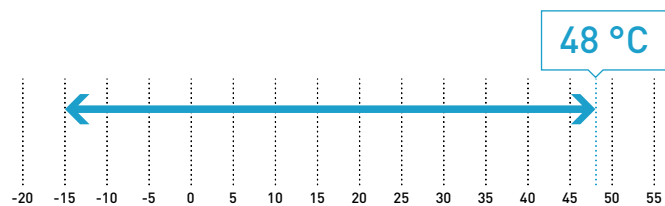

Water outlet temperature.

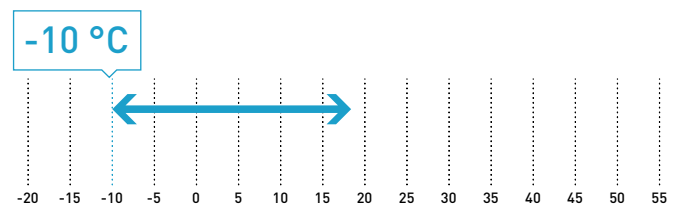

Cooling: Outside air temperature [°C (DB)].

Available options

Options					
Pump	Pump drive	Hydraulic options	Ambient options	Control options	Electrical options
Single pump low pressure	Fixed speed	Low water pressure sensor ¹⁾	Finned coil treatment - epoxy	Digital input for: Cooling/heating or Night mode or Load Shedding	EC fan(s) option
Single pump high pressure	Variable twin speed (single pump)	Desuperheater	Finned coil Blygold treatment		Soft starter
Double pump low pressure	Variable twin speed (double pump)	Water isolation valves	Outdoor coil protection grid		Refrigerant options
Double pump high pressure	Constant outlet pressure (single pump) ²⁾		Rubber pads (supplied loose)		Refrigerant gauges (HP and LP manometers)
	Constant outlet pressure (double pump) ²⁾		Spring damper (supplied loose)		
			Container transport		
			Acoustically insulating compressor jacket		

1) Low water pressure sensor is supplied loose when selected as an option without pump and hydraulic kit. To be installed on site. 2) Available on special quotation, please contact your local sales representative.



REFER TO PAGE 436 TO SEE MORE OPTIONS FOR R32 OUTDOOR UNITS



Optional controller.
PAW-SYSREMKIT1



Optional Shut off valves
kit for model 85-170.
PAW-SYSSOV5

Model	85			100			115			130				
AC fan model w/o buffer / w buffer	U-085CQNB/U-085CQBL			U-100CQNB/U-100CQBL			U-115CQNB/U-115CQBL			U-130CQNB/U-130CQBL				
EC fan model w/o buffer / w buffer	U-085CRNB/U-085CRBL			U-100CRNB/U-100CRBL			U-115CRNB/U-115CRBL			U-130CRNB/U-130CRBL				
High pressure EC fan model w/o buffer / w buffer	U-085CSNB/U-085CSBL			U-100CSNB/U-100CSBL			U-115CSNB/U-115CSBL			U-130CSNB/U-130CSBL				
Power supply	Voltage	V	400			400			400			400		
	Phase		Three phase			Three phase			Three phase			Three phase		
	Frequency	Hz	50			50			50			50		
Cooling capacity ¹⁾		kW	84,2			102,0			121,0			135,0		
Input power ¹⁾		kW	29,1			34,1			37,7			42,4		
Total EER 100% ¹⁾			2,89			3,00			3,20			3,18		
SEER ²⁾	AC / EC		4,52/5,12			4,30/4,92			4,53/4,72			4,47/4,61		
η_{s,c} ²⁾	AC / EC	%	178/202			169/194			178/186			176/181		
Startup type			Direct			Direct			Direct			Direct		
Maximum operating current		A	75,0			86,6			93,8			104,2		
Startup current w/o / w softstarter		A	215/129			326/240			333/247			343/257		
Sound power (w AC/EC / HP EC fans)		dB(A)	84,4/89,3			86,0/89,7			87,0/90,0			87,4/90,2		
Sound pressure (w AC/EC / HP EC fans) ³⁾		dB(A)	52,5/57,4			54,1/57,8			55,1/58,1			55,5/58,3		
Dimension (w AC fans) w/o buffer	HxWxD	mm	2286x2180x1160			2286x2180x1160			2286x2180x1160			2286x2180x1160		
Dimension (w AC fans) w buffer	HxWxD	mm	2286x2680x1160			2286x2680x1160			2286x2680x1160			2286x2680x1160		
Dimension (w EC/HP EC fans) w/o buffer	HxWxD	mm	2334x2180x1160			2334x2180x1160			2334x2180x1160			2334x2180x1160		
Dimension (w EC/HP EC fans) w buffer	HxWxD	mm	2334x2680x1160			2334x2680x1160			2334x2680x1160			2334x2680x1160		
Operating weight w/o buffer / w buffer		kg	701/1202			731/1232			813/1317			815/1319		
Refrigerant (R32)		kg	12,8			10,9			13,0			15,0		
Number of refrigerant circuit			1			1			1			1		
Compressors														
Number			2			2			2			2		
Type			Scroll			Scroll			Scroll			Scroll		
Part load step		%	0/50/100			0/34/66/100			0/44/56/100			0/50/100		
Crankcase heater		W	66/66			66/66			66/66			66/66		
Evaporator														
Number			1			1			1			1		
Type			Plate			Plate			Plate			Plate		
Nominal water flow	Cool	m ³ /h	14,7			17,9			21,1			23,6		
Water pressure drop	Cool	kPa	22,6			33,5			46,6			58,1		
Water volume		l	7,8			7,8			7,8			7,8		
Antifreeze heater		W	2x30			2x30			2x30			2x30		
Coils														
Number			2			2			2			2		
Frontal surface		m ²	6,4			6,4			6,4			6,4		
Number of rows			2			2			3			3		
Fans standard														
Number			AC	EC	HP EC	AC	EC	HP EC	AC	EC	HP EC	AC	EC	HP EC
Number			2			2			2			2		
Air flow		m ³ /h	41300	41300	41300	41300	41300	41300	41300	41300	41300	41300	41300	41300
Rotation speed		r.p.m.	870	780	940	870	780	940	870	780	940	870	780	940
Input power (each fan)		kW	2,1	0,8	1,6	2,1	0,8	1,6	1,6	1,0	1,6	1,6	1,0	1,6
Static pressure (HP EC)		Pa	85			85			85			85		
Water connections														
Type			Male gas threaded BSPP ISO 228			Male gas threaded BSPP ISO 228			Male gas threaded BSPP ISO 228			Male gas threaded BSPP ISO 228		
Inlet - Outlet - diameter	Evaporator	Inch	2 ½ - 2 ½			2 ½ - 2 ½			2 ½ - 2 ½			2 ½ - 2 ½		
Inlet - Outlet - diameter	Desuperheater	Inch	1 ¼ - 1 ¼			1 ¼ - 1 ¼			1 ¼ - 1 ¼			1 ¼ - 1 ¼		

1) Data refers to 7 °C leaving chilled water temperature and 35 °C condenser air temperature, according EN14511 standard. 2) Following COMMISSION REGULATION (EU) No 2016/2281 for comfort application chillers. 3) Sound pressure levels calculated at 10 meters. Sound pressure levels refer to ISO standard 3744 with parallel piped shape.
* w: with, w/o: without. ** The data are calculated with variable flow.

Accessories	
PAW-SYSREMKIT1	Remote control
PAW-CM000SP041	Cloudgate Plug & Play IP65 box mobile 4G Europe
PAW-CM000K0001	Remote antenna to improve signal coverage

Accessories	
PAW-00SRTS011	ECOi-W Cloud service fee. Prepaid subscription for 1 year
PAW-SYSSOV5	Shut off valves kit for model 85 - 170





U - 150/170 CQ, CR, CS

Cooling capacity: 156,0 to 176,0 kW

Powerful and efficient operation with 2 scroll compressors and superior flexibility with Plug & Play hydraulic options.

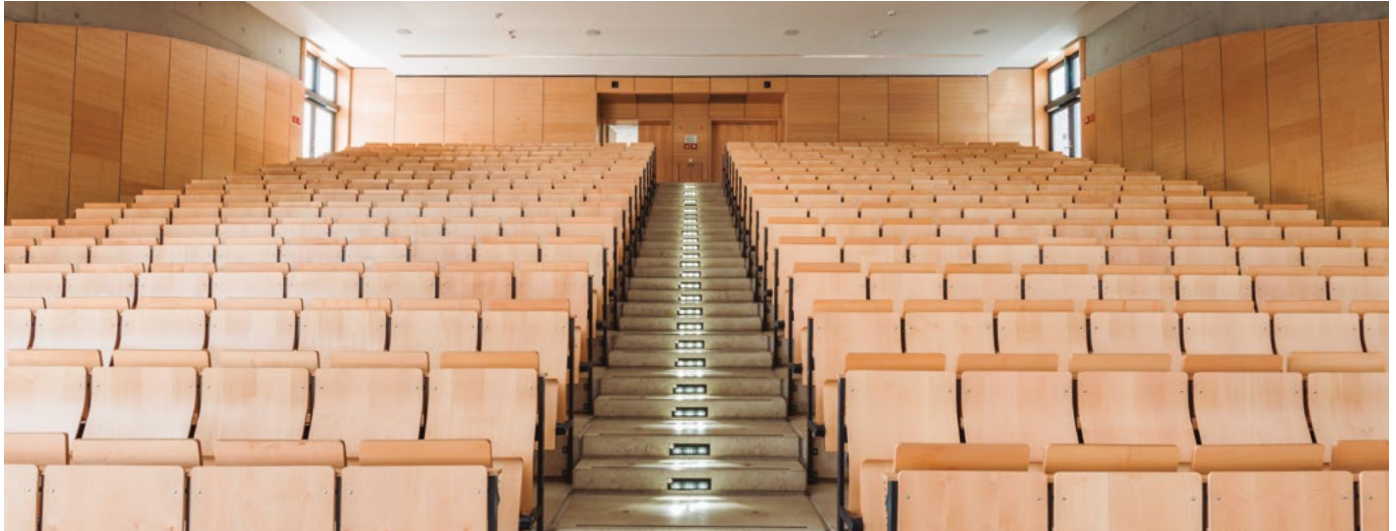

- High seasonal efficiency
- Ambient temperature operating range: -15 to +47 °C
- Water outlet temperature range: -10 to +18 °C
- Victaulic® water connections
- Optimised design for service and maintenance
- Simple user friendly control as standard
- Modbus RTU & TCP/IP, BACnet MSTP & IP as standard
- Electronic expansion valve

Technical focus

- Chiller type: cooling only
- Compressor type (number): Scroll compressors (2)
- Refrigerant type: R32
- Refrigerant circuit: 2
- Fan type (number): axial fan (3), optional EC and high pressure EC fans
- Heat exchanger: stainless steel plate heat exchanger
- Flow switch, water safety and air purge valves included
- Water filter included (mandatory to be installed on site)
- Night mode setting to save energy and reduce noise level
- Water compensation curve control

Ambient temperature.

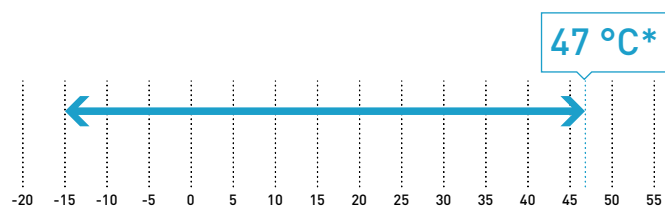

Water outlet temperature.

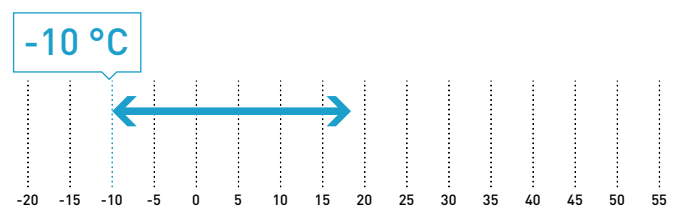

Cooling: Outside air temperature [°C (DB)]. * Full capacity up to 42 °C.

Available options

Options					
Pump	Pump drive	Hydraulic options	Ambient options	Control options	Electrical options
Single pump low pressure	Fixed speed	Low water pressure sensor ¹⁾	Finned coil treatment - epoxy	Digital input for: Cooling/heating or Night mode or Load Shedding	EC fan(s) option
Single pump high pressure	Variable twin speed (single pump)	Desuperheater	Finned coil Blygold treatment		Power factor correction capacitors
Double pump low pressure	Variable twin speed (double pump)	Water isolation valves	Outdoor coil protection grid		Soft starter
Double pump high pressure	Constant outlet pressure (single pump) ²⁾		Rubber pads (supplied loose)		
	Constant outlet pressure (double pump) ²⁾		Spring damper (supplied loose)		
			Container transport		
			Acoustically insulating compressor jacket		
					Refrigerant options
					Refrigerant gauges (HP and LP manometers)

1) Low water pressure sensor is supplied loose when selected as an option without pump and hydraulic kit. To be installed on site. 2) Available on special quotation, please contact your local sales representative.



REFER TO PAGE 436 TO SEE MORE OPTIONS FOR R32 OUTDOOR UNITS



Optional controller.
PAW-SYSREMKIT1



Optional Shut off valves
kit for model 85-170.
PAW-SYSSOV5

Model	150			170				
AC fan model w/o buffer / w buffer	U-150CQNB / U-150CQBL			U-170CQNB / U-170CQBL				
EC fan model w/o buffer / w buffer	U-150CRNB / U-150CRBL			U-170CRNB / U-170CRBL				
High pressure EC fan model w/o buffer / w buffer	U-150CSNB / U-150CSBL			U-170CSNB / U-170CSBL				
Power supply	Voltage	V	400	400				
	Phase		Three phase	Three phase				
	Frequency	Hz	50	50				
Cooling capacity ¹⁾		kW	156,0	176,0				
Input power ¹⁾		kW	47,9	55,5				
Total EER 100% ¹⁾			3,26	3,17				
SEER ²⁾	AC / EC		4,64 / 4,92	4,56 / 4,95				
η_{s,c} ²⁾	AC / EC	%	183 / 194	179 / 195				
Startup type			Direct	Direct				
Maximum operating current		A	125,0	142,0				
Startup current w/o / w softstarter		A	363 / 277	380 / 294				
Sound power (w AC/EC / HP EC fans)		dB(A)	88,9 / 91,6	91,1 / 92,3				
Sound pressure (w AC/EC / HP EC fans) ³⁾		dB(A)	57,0 / 59,7	59,2 / 60,4				
Dimension (w AC fans) w/o buffer	HxWxD	mm	2285x3789x1151	2285x3789x1151				
Dimension (w AC fans) w buffer	HxWxD	mm	2285x3789x1151	2285x3789x1151				
Dimension (w EC/HP EC fans) w/o buffer	HxWxD	mm	2333x3789x1151	2333x3789x1151				
Dimension (w EC/HP EC fans) w buffer	HxWxD	mm	2333x3789x1151	2333x3789x1151				
Operating weight w/o buffer / w buffer		kg	1265 / 1683	1279 / 1697				
Refrigerant (R32)		kg	19,2	20,0				
Number of refrigerant circuit			1	1				
Compressors								
Number			2	2				
Type			Scroll	Scroll				
Part load step		%	0 / 45 / 55 / 100	0 / 38 / 62 / 100				
Crankcase heater		W	66 / 105	66 / 105				
Evaporator								
Number			1	1				
Type			Plate	Plate				
Nominal water flow	Cool	m ³ /h	27,3	30,7				
Water pressure drop	Cool	kPa	39,1	49,7				
Water volume		l	11,5	12,9				
Antifreeze heater		W	130	130				
Coils								
Number			2	2				
Frontal surface		m ²	8,7	8,7				
Number of rows			3	3				
Fans standard								
			AC	EC	HP EC	AC	EC	HP EC
Number			3	3	3	3	3	3
Air flow		m ³ /h	56205	56205	56205	56205	56205	56205
Rotation speed		r.p.m.	870	780	940	870	780	940
Input power (each fan)		kW	1,4	0,8	1,7	1,4	0,8	1,7
Static pressure (HP EC)		Pa		110			110	
Water connections								
Type			Male gas threaded BSPP ISO 228			Male gas threaded BSPP ISO 228		
Inlet - Outlet - diameter	Evaporator	Inch	2 ½ - 2 ½			2 ½ - 2 ½		
Inlet - Outlet - diameter	Desuperheater	Inch	1 ¼ - 1 ¼			1 ¼ - 1 ¼		

1) Data refers to 7 °C leaving chilled water temperature and 35 °C condenser air temperature, according EN14511 standard. 2) Following COMMISSION REGULATION (EU) No 2016/2281 for comfort application chillers. 3) Sound pressure levels calculated at 10 meters. Sound pressure levels refer to ISO standard 3744 with parallel piped shape.
* w: with, w/o: without. ** The data are calculated with variable flow.

Accessories	
PAW-SYSREMKIT1	Remote control
PAW-CM000SP041	Cloudgate Plug & Play IP65 box mobile 4G Europe
PAW-CM000K001	Remote antenna to improve signal coverage

Accessories	
PAW-00SRTS011	ECOi-W Cloud service fee. Prepaid subscription for 1 year
PAW-SYSSOV5	Shut off valves kit for model 85 - 170





U - 050/060/070/075 CM, CN, CO

Cooling capacity: 49,9 to 75,3 kW

Heating capacity: 53,5 to 80,0 kW

High seasonal efficiency in cooling, maximum SEER 4,54 in this range. ECOi-W Series offers a variety of options to meet your needs.



- High seasonal efficiency in cooling and heating
- Ambient temperature operating range: -15 to +48 °C in cooling, -15 to +40 °C ¹⁾ in heating
- Water outlet temperature range: -10 to +18 °C in cooling, +20 to +55 °C in heating
- Optional acoustically insulating compressor jacket
- Optimised design for service and maintenance
- Simple user friendly control as standard
- Modbus RTU & TCP/IP, BACnet MSTP & IP as standard
- Electronic expansion valve

Technical focus

- Chiller type: heat pump
- Compressor type (number): Scroll compressors (2)
- Refrigerant type: R32
- Refrigerant circuit: 1
- Fan type (number): axial fan (1 for 50/60, 2 for 70/75), optional EC and high pressure EC fans
- Heat exchanger: stainless steel plate heat exchanger
- Flow switch, water safety and air purge valves included
- Water filter included (mandatory to be installed on site)
- Night mode setting to save energy and reduce noise level
- Water compensation curve control
- Bluefin anti-corrosion coating

Ambient temperature.

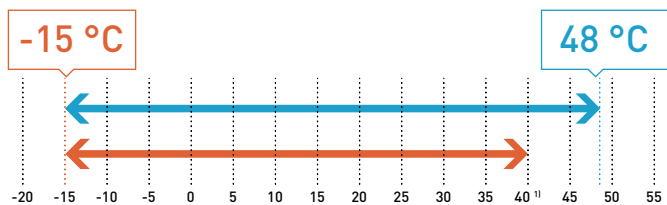

Cooling: Outside air temperature (°C (DB)). Heating: Outside air temperature (°C (WB)). 1) With EC fan.

Water outlet temperature.

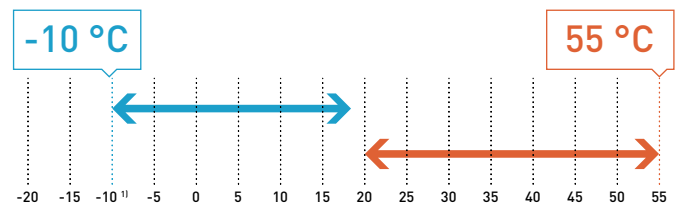

Available options

Options	Pump drive	Hydraulic options	Ambient options	Control options	Electrical options
Single pump low pressure	Fixed speed	Low water pressure sensor ¹⁾	Finned coil treatment - epoxy	Digital input for: Cooling/heating or Night mode or Load Shedding	EC fan(s) option
Single pump high pressure	Variable twin speed (single pump)	Desuperheater	Finned coil Blygold treatment		Soft starter
Double pump low pressure	Variable twin speed (double pump)	Water isolation valves	Outdoor coil protection grid		Refrigerant options
Double pump high pressure	Constant outlet pressure (single pump) ²⁾		Rubber pads (supplied loose)		Refrigerant gauges (HP and LP manometers)
	Constant outlet pressure (double pump) ²⁾		Spring damper (supplied loose)		
			Container transport		
			Acoustically insulating compressor jacket		

1) Low water pressure sensor is supplied loose when selected as an option without pump and hydraulic kit. To be installed on site. 2) Available on special quotation, please contact your local sales representative.



+ REFER TO PAGE 436 TO SEE MORE OPTIONS FOR R32 OUTDOOR UNITS



Optional controller.
PAW-SYSREMKIT1



Optional Shut off valves
kit for model 50 - 75.
PAW-SYSSOV4

Model	50			60			70			75						
AC fan model w/o buffer / w buffer	U-050CMNB/U-050CMBM			U-060CMNB/U-060CMBM			U-070CMNB/U-070CMBM			U-075CMNB/U-075CMBM						
EC fan model w/o buffer / w buffer	U-050CNB/U-050CNBM			U-060CNB/U-060CNBM			U-070CNB/U-070CNBM			U-075CNB/U-075CNBM						
High pressure EC fan model w/o buffer / w buffer	U-050CONB/U-050COBM			U-060CONB/U-060COBM			U-070CONB/U-070COBM			U-075CONB/U-075COBM						
Power supply	Voltage	V			400			400			400					
	Phase	Three phase			Three phase			Three phase			Three phase					
	Frequency	Hz			50			50			50					
Cooling capacity ¹⁾	kW			49,9			60,4			70,0			75,3			
Input power ¹⁾	kW			17,0			19,8			22,3			25,7			
Total EER 100% ¹⁾				2,94			3,05			3,15			2,93			
SEER ²⁾³⁾	AC / EC	4,36 / 4,58			4,32 / 4,77			4,54 / 4,95			4,47 / 4,68					
η _{s,c} ²⁾³⁾	AC / EC	171 / 180			170 / 188			178 / 195			176 / 184					
Heating capacity ⁴⁾	kW			53,5			61,5			71,7			80,0			
Input power ⁴⁾	kW			17,3			19,5			22,2			24,7			
SCOP ³⁾⁵⁾	AC / EC	3,63 / 3,85			3,52 / 3,88			3,55 / 3,80			3,57 / 3,80					
η _{s,c} ³⁾⁵⁾	AC / EC	142 / 151			138 / 152			139 / 149			140 / 149					
Energy efficiency class (Scale A+++ to D) ⁶⁾	AC / EC	A+ / A+			A+ / A+			A+ / A+			A+ / A+					
Startup type	Direct			Direct			Direct			Direct						
Maximum operating current	A	43,3			52,7			60,0			69,4					
Startup current w/o / w softstarter	A	161 / 119			162 / 120			200 / 148			209 / 157					
Sound power (w AC/EC / HP EC fans)	dB(A)	83,2/87,2			83,8/87,3			81,3/89,2			81,3/89,3					
Sound pressure (w AC/EC / HP EC fans) ⁷⁾	dB(A)	51,4/55,4			52,0/55,5			49,5/57,4			49,5/57,5					
Dimension (w AC fans) w/o buffer	H x W x D	mm			1986 x 2180 x 1160			1986 x 2180 x 1160			1986 x 2180 x 1160					
Dimension (w AC fans) w buffer	H x W x D	mm			1986 x 2680 x 1160			1986 x 2680 x 1160			1986 x 2680 x 1160					
Dimension (w EC/HP EC fans) w/o buffer	H x W x D	mm			2034 x 2180 x 1160			2034 x 2180 x 1160			2034 x 2180 x 1160					
Dimension (w EC/HP EC fans) w buffer	H x W x D	mm			2034 x 2680 x 1160			2034 x 2680 x 1160			2034 x 2680 x 1160					
Operating weight w/o buffer / w buffer	kg	527 / 1018			547 / 1038			621 / 1114			637 / 1130					
Refrigerant (R32)	kg	7,9			8,1			10,3			10,6					
Number of refrigerant circuit		1			1			1			1					
Compressors																
Number/Type	2/Scroll			2/Scroll			2/Scroll			2/Scroll						
Part load step	%	0 / 47 / 53 / 100			0 / 41 / 59 / 100			0 / 40 / 60 / 100			0 / 46 / 54 / 100					
Crankcase heater	W	70 / 70			70 / 66			70 / 66			66 / 66					
Evaporator																
Number/Type	1/Plate			1/Plate			1/Plate			1/Plate						
Nominal water flow	Cool / Heat	m ³ /h			8,7 / 9,3			10,6 / 10,7			12,2 / 12,5			13,2 / 13,9		
Water pressure drop	Cool / Heat	kPa			31,8 / 36,4			46,8 / 48,1			33,1 / 34,4			38,2 / 42,8		
Water volume	l	4,1			4,1			6,1			6,1					
Antifreeze heater	W	30			30			2 x 30			2 x 30					
Coils																
Number	1			1			2			2						
Frontal surface	m ²	4,2			4,2			5,6			5,6					
Number of rows	2			2			2			2						
Fans standard																
Number	AC	EC	HP EC	AC	EC	HP EC	AC	EC	HP EC	AC	EC	HP EC				
Number	1			1			2			2						
Air flow	m ³ /h	21200	21200	21200	21200	21200	21200	30000	30000	30000	30000	30000	30000			
Rotation speed	r.p.m.	870	780	940	870	780	940	690	620	940	690	620	940			
Input power (each fan)	kW	2,1	1,1	1,6	2,1	1,1	1,6	1,0	0,6	1,9	1,0	0,6	1,9			
Static pressure (HP EC)	Pa	85			85			180			180					
Water connections																
Type	Male gas threaded BSPP ISO 228			Male gas threaded BSPP ISO 228			Male gas threaded BSPP ISO 228			Male gas threaded BSPP ISO 228						
Inlet - Outlet - diameter	Evaporator	Inch	2 - 2			2 - 2			2 - 2			2 - 2				
Inlet - Outlet - diameter	Desuperheater	Inch	1 1/4 - 1 1/4			1 1/4 - 1 1/4			1 1/4 - 1 1/4			1 1/4 - 1 1/4				

1) Data refers to 7 °C leaving chilled water temperature and 35 °C condenser air temperature, according EN14511 standard. 2) Following COMMISSION REGULATION (EU) No 2016/2281 for comfort application chillers. 3) Those are the data with variable flow. 4) Data refers to 45 °C leaving warm water temperature and 7 °C ambient coil air temperature with 87% R.H., according EN14511 standard. 5) Following COMMISSION REGULATION (EU) No 813/2013 for low-temperature heat pumps. 6) Following Eurovent and COMMISSION REGULATION (EU) No 811/2013 for low-temperature heat pumps. Scale from A+++ to D, as of 26th September 2019. 7) Sound pressure levels calculated at 10 meters. Sound pressure levels refer to ISO standard 3744 with parallel piped shape.

* w: with, w/o: without.

Accessories	
PAW-SYSREMKIT1	Remote control
PAW-CM000SP041	Cloudgate Plug & Play IP65 box mobile 4G Europe
PAW-CM000K0001	Remote antenna to improve signal coverage

Accessories	
PAW-00SRTS011	ECOi-W Cloud service fee. Prepaid subscription for 1 year
PAW-SYSSOV4	Shut off valves kit for model 50 - 75





U - 085/100/115/130 CM, CN, CO

Cooling capacity: 84,2 to 135,0 kW
Heating capacity: 86,2 to 137,0 kW

Customizable design gives high flexibility. Wide range of communication protocols fulfill the requirements in hotels, offices, industry applications.



- High seasonal efficiency in cooling and heating
- Ambient temperature operating range: -15 to +48 °C in cooling, -15 to +40 °C ¹⁾ in heating
- Water outlet temperature range: -10 to +18 °C in cooling, +20 to +55 °C in heating
- Optional acoustically insulating compressor jacket
- Optimised design for service and maintenance
- Simple user friendly control as standard
- Modbus RTU & TCP/IP, BACnet MSTP & IP as standard
- Electronic expansion valve

Technical focus

- Chiller type: heat pump
- Compressor type (number): Scroll compressors (2)
- Refrigerant type: R32
- Refrigerant circuit: 1
- Fan type (number): axial fan (2), optional EC and high pressure EC fans
- Heat exchanger: stainless steel plate heat exchanger
- Flow switch, water safety and air purge valves included
- Water filter included (mandatory to be installed on site)
- Night mode setting to save energy and reduce noise level
- Water compensation curve control
- Bluefin anti-corrosion coating

Ambient temperature.

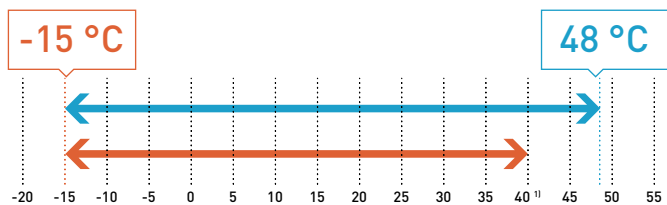

Cooling: Outside air temperature (°C [DB]). Heating: Outside air temperature (°C [WB]). 1) With EC fan.

Water outlet temperature.

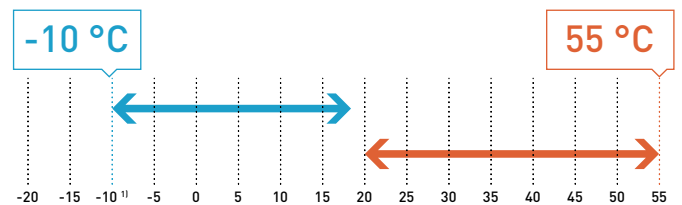

Available options

Options					
Pump	Pump drive	Hydraulic options	Ambient options	Control options	Electrical options
Single pump low pressure	Fixed speed	Low water pressure sensor ¹⁾	Finned coil treatment - epoxy	Digital input for: Cooling/heating or Night mode or Load Shedding	EC fan(s) option
Single pump high pressure	Variable twin speed (single pump)	Desuperheater	Finned coil Blygold treatment		Soft starter
Double pump low pressure	Variable twin speed (double pump)	Water isolation valves	Outdoor coil protection grid		Refrigerant options
Double pump high pressure	Constant outlet pressure (single pump) ²⁾		Rubber pads (supplied loose)		Refrigerant gauges (HP and LP manometers)
	Constant outlet pressure (double pump) ²⁾		Spring damper (supplied loose)		
			Container transport		
			Acoustically insulating compressor jacket		

1) Low water pressure sensor is supplied loose when selected as an option without pump and hydraulic kit. To be installed on site. 2) Available on special quotation, please contact your local sales representative.



REFER TO PAGE 436 TO SEE MORE OPTIONS FOR R32 OUTDOOR UNITS



Optional controller.
PAW-SYSREMKIT1



Optional Shut off valves
kit for model 85 - 170.
PAW-SYSSOV5

Model	85			100			115			130				
AC fan model w/o buffer / w buffer	U-085CMNB/U-085CMBL			U-100CMNB/U-100CMBL			U-115CMNB/U-115CMBL			U-130CMNB/U-130CMBL				
EC fan model w/o buffer / w buffer	U-085CNB/U-085CNBL			U-100CNB/U-100CNBL			U-115CNB/U-115CNBL			U-130CNB/U-130CNBL				
High pressure EC fan model w/o buffer / w buffer	U-085CONB/U-085COBL			U-100CONB/U-100COBL			U-115CONB/U-115COBL			U-130CONB/U-130COBL				
Power supply	Voltage	V	400			400			400			400		
	Phase		Three phase			Three phase			Three phase			Three phase		
	Frequency	Hz	50			50			50			50		
Cooling capacity ¹⁾		kW	84,2			102,0			121,0			135,0		
Input power ¹⁾		kW	29,1			34,1			37,7			42,4		
Total EER 100% ¹⁾			2,89			3,00			3,20			3,18		
SEER ^{2) 3)}	AC / EC		4,48 / 5,05			4,35 / 4,96			4,34 / 4,52			4,33 / 4,48		
η _{s,c} ^{2) 3)}	AC / EC	%	176 / 199			171 / 196			171 / 178			170 / 176		
Heating capacity ⁴⁾		kW	86,2			105,0			123,0			137,0		
Input power ⁴⁾		kW	28,5			33,3			36,9			40,6		
SCOP ^{3) 5)}	AC / EC		3,57 / 3,98			3,63 / 3,98			3,60 / 3,80			3,73 / 3,90		
η _{s,c} ^{3) 5)}	AC / EC	%	140 / 156			142 / 156			141 / 149			146 / 153		
Startup type			Direct			Direct			Direct			Direct		
Maximum operating current		A	75,0			86,6			93,8			104,2		
Startup current w/o / w softstarter		A	215 / 129			326 / 240			333 / 247			343 / 257		
Sound power (w AC/EC / HP EC fans)		dB(A)	84,4 / 89,3			86,0 / 89,7			87,0 / 90,0			87,4 / 90,2		
Sound pressure (w AC/EC / HP EC fans) ⁶⁾		dB(A)	52,5 / 57,4			54,1 / 57,8			55,1 / 58,1			55,5 / 58,3		
Dimension (w AC fans) w/o buffer	H x W x D	mm	2286 x 2180 x 1160			2286 x 2180 x 1160			2286 x 2180 x 1160			2286 x 2180 x 1160		
Dimension (w AC fans) w buffer	H x W x D	mm	2286 x 2680 x 1160			2286 x 2680 x 1160			2286 x 2680 x 1160			2286 x 2680 x 1160		
Dimension (w EC/HP EC fans) w/o buffer	H x W x D	mm	2334 x 2180 x 1160			2334 x 2180 x 1160			2334 x 2180 x 1160			2334 x 2180 x 1160		
Dimension (w EC/HP EC fans) w buffer	H x W x D	mm	2334 x 2680 x 1160			2334 x 2680 x 1160			2334 x 2680 x 1160			2334 x 2680 x 1160		
Operating weight w/o buffer / w buffer		kg	701 / 1202			731 / 1232			813 / 1317			815 / 1319		
Refrigerant (R32)		kg	12,8			10,9			13,0			15,0		
Number of refrigerant circuit			1			1			1			1		
Compressors														
Number/Type			2/Scroll			2/Scroll			2/Scroll			2/Scroll		
Part load step		%	0/50/100			0/34/66/100			0/44/56/100			0/50/100		
Crankcase heater		W	66/66			66/66			66/66			66/66		
Evaporator														
Number/Type			1/Plate			1/Plate			1/Plate			1/Plate		
Nominal water flow	Cool / Heat	m ³ /h	14,7/15,0			17,9/18,3			21,1/21,5			23,6/23,9		
Water pressure drop	Cool / Heat	kPa	22,6/23,6			33,5/35,3			46,6/48,4			58,1/59,7		
Water volume		l	7,8			7,8			7,8			7,8		
Antifreeze heater		W	2x30			2x30			2x30			2x30		
Coils														
Number			2			2			2			2		
Frontal surface		m ²	6,4			6,4			6,4			6,4		
Number of rows			2			2			3			3		
Fans standard														
Number			AC	EC	HP EC	AC	EC	HP EC	AC	EC	HP EC	AC	EC	HP EC
Number			2			2			2			2		
Air flow		m ³ /h	41300	41300	41300	41300	41300	41300	41300	41300	41300	41300	41300	41300
Rotation speed		r.p.m.	870	780	940	870	780	940	870	780	940	870	780	940
Input power (each fan)		kW	2,1	0,8	1,6	2,1	0,8	1,6	1,6	1,0	1,6	1,6	1,0	1,6
Static pressure (HP EC)		Pa	85			85			85			85		
Water connections														
Type			Male gas threaded BSPP ISO 228			Male gas threaded BSPP ISO 228			Male gas threaded BSPP ISO 228			Male gas threaded BSPP ISO 228		
Inlet - Outlet - diameter	Evaporator	Inch	2 1/2 - 2 1/2			2 1/2 - 2 1/2			2 1/2 - 2 1/2			2 1/2 - 2 1/2		
Inlet - Outlet - diameter	Desuperheater	Inch	1 1/4 - 1 1/4			1 1/4 - 1 1/4			1 1/4 - 1 1/4			1 1/4 - 1 1/4		

1) Data refers to 7 °C leaving chilled water temperature and 35 °C condenser air temperature, according EN14511 standard. 2) Following COMMISSION REGULATION (EU) No 2016/2281 for comfort application chillers. 3) Those are the data with variable flow. 4) Data refers to 45 °C leaving warm water temperature and 7 °C ambient coil air temperature with 87% R.H., according EN14511 standard. 5) Following COMMISSION REGULATION (EU) No 813/2013 for low-temperature heat pumps. 6) Sound pressure levels calculated at 10 meters. Sound pressure levels refer to ISO standard 3744 with parallel piped shape. * w: with, w/o: without.

Accessories	
PAW-SYSREMKIT1	Remote control
PAW-CM000SP041	Cloudgate Plug & Play IP65 box mobile 4G Europe
PAW-CM000K0001	Remote antenna to improve signal coverage

Accessories	
PAW-00SRTS011	ECOi-W Cloud service fee. Prepaid subscription for 1 year
PAW-SYSSOV5	Shut off valves kit for model 85 - 170





U - 150/170 CM, CN, CO

Cooling capacity: 156,0 to 176,0 kW

Heating capacity: 158,0 to 182,0 kW

Heat pump chiller series with powerful operation by 2 scroll compressors. Maximum water outlet temperature in heating is up to 53 °C. Defrost limiting design ensures to provide stable hot water even at low ambient conditions.



- High seasonal efficiency in cooling and heating
- Ambient temperature operating range: -15 to +47 °C in cooling, -15 to +40 °C ¹⁾ in heating
- Water outlet temperature range: -10 to +18 °C in cooling, +20 to +53 °C in heating
- Optional acoustically insulating compressor jacket
- Victaulic® water connections
- Optimised design for service and maintenance
- Simple user friendly control as standard
- Modbus RTU & TCP/IP, BACnet MSTP & IP as standard
- Electronic expansion valve

Technical focus

- Chiller type: heat pump
- Compressor type (number): Scroll compressors (2)
- Refrigerant type: R32
- Refrigerant circuit: 1
- Fan type (number): axial fan (3), optional AC, EC and high pressure EC fans
- Heat exchanger: stainless steel plate heat exchanger
- Flow switch, water safety and air purge valves included
- Water filter included (mandatory to be installed on site)
- Night mode setting to save energy and reduce noise level
- Water compensation curve control
- Bluefin anti-corrosion coating
- Remote LAN connection as standard

Ambient temperature.

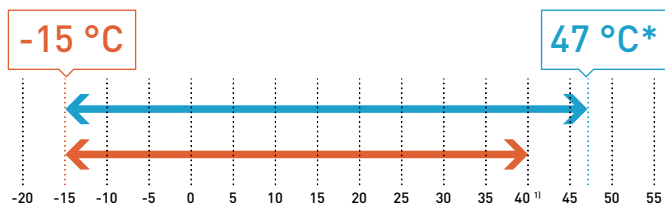

Water outlet temperature.

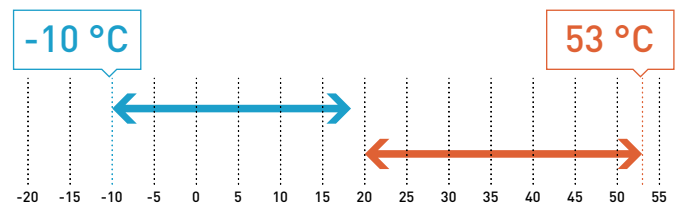

Cooling: Outside air temperature [°C (DB)]. Heating: Outside air temperature [°C (WB)]. 1) With EC fan. * Full capacity up to 42 °C.

Available options

Options					
Pump	Pump drive	Hydraulic options	Ambient options	Control options	Electrical options
Single pump low pressure	Fixed speed	Low water pressure sensor ¹⁾	Finned coil treatment - epoxy	Digital input for: Cooling/heating or Night mode or Load Shedding	EC fan(s) option
Single pump high pressure	Variable twin speed (single pump)	Desuperheater	Finned coil Blygold treatment		Power factor correction capacitors
Double pump low pressure	Variable twin speed (double pump)	Water isolation valves	Outdoor coil protection grid		Soft starter
Double pump high pressure	Constant outlet pressure (single pump) ²⁾		Rubber pads (supplied loose)		
	Constant outlet pressure (double pump) ²⁾		Spring damper (supplied loose)		
			Container transport		
			Acoustically insulating compressor jacket		
					Refrigerant options
					Refrigerant gauges (HP and LP manometers)

1) Low water pressure sensor is supplied loose when selected as an option without pump and hydraulic kit. To be installed on site. 2) Available on special quotation, please contact your local sales representative.



+ REFER TO PAGE 436 TO SEE MORE OPTIONS FOR R32 OUTDOOR UNITS



Optional controller.
PAW-SYSREMKIT1



Optional Shut off valves
kit for model 85 - 170.
PAW-SYSSOV5

Model	150			170				
AC fan model w/o buffer / w buffer	U-150CMNB / U-150CMBL			U-170CMNB / U-170CMBL				
EC fan model w/o buffer / w buffer	U-150CNNB / U-150CNBL			U-170CNNB / U-170CNBL				
High pressure EC fan model w/o buffer / w buffer	U-150CONB / U-150COBL			U-170CONB / U-170COBL				
Power supply	Voltage	V	400	400				
	Phase		Three phase	Three phase				
	Frequency	Hz	50	50				
Cooling capacity ¹⁾		kW	156,0	176,0				
Input power ¹⁾		kW	47,9	55,5				
Total EER 100% ¹⁾			3,26	3,17				
SEER ^{2) 3)}	AC / EC		4,61 / 4,90	4,62 / 5,03				
η_{s,c} ^{2) 3)}	AC / EC	%	181 / 193	182 / 198				
Heating capacity ⁴⁾		kW	158,0	182,0				
Input power ⁴⁾		kW	47,7	54,0				
SCOP ^{3) 5)}	AC / EC		3,65 / 3,88	3,60 / 3,85				
η_{s,c} ^{3) 5)}	AC / EC	%	143 / 152	141 / 151				
Startup type			Direct	Direct				
Maximum operating current		A	125	142				
Startup current w/o / w softstarter		A	363 / 277	380 / 294				
Sound power (w AC/EC / HP EC fans)		dB(A)	88,9 / 91,6	91,1 / 92,3				
Sound pressure (w AC/EC / HP EC fans) ⁶⁾		dB(A)	57,0 / 59,7	59,2 / 60,4				
Dimension (w AC fans) w/o buffer	H x W x D	mm	2285 x 3789 x 1151	2285 x 3789 x 1151				
Dimension (w AC fans) w buffer	H x W x D	mm	2285 x 3789 x 1151	2285 x 3789 x 1151				
Dimension (w EC/HP EC fans) w/o buffer	H x W x D	mm	2333 x 3789 x 1151	2333 x 3789 x 1151				
Dimension (w EC/HP EC fans) w buffer	H x W x D	mm	2333 x 3789 x 1151	2333 x 3789 x 1151				
Operating weight w/o buffer / w buffer		kg	1265 / 1683	1279 / 1697				
Refrigerant (R32)		kg	19,2	20,0				
Number of refrigerant circuit			1	1				
Compressors								
Number / Type			2 / Scroll	2 / Scroll				
Part load step		%	0 / 45 / 55 / 100	0 / 38 / 62 / 100				
Crankcase heater		W	66 / 105	66 / 105				
Evaporator								
Number / Type			1 / Plate	1 / Plate				
Nominal water flow	Cool / Heat	m ³ /h	27,3 / 27,5	30,7 / 31,7				
Water pressure drop	Cool / Heat	kPa	39,1 / 39,9	49,7 / 52,9				
Water volume		l	11,5	12,9				
Antifreeze heater		W	130	130				
Coils								
Number			2	2				
Frontal surface		m ²	8,7	8,7				
Number of rows			3	3				
Fans standard			AC	EC	HP EC	AC	EC	HP EC
Number			3	3	3	3	3	3
Air flow		m ³ /h	56205	56205	56205	56205	56205	56205
Rotation speed		r.p.m.	870	780	940	870	780	940
Input power (each fan)		kW	1,4	0,8	1,7	1,4	0,8	1,7
Static pressure (HP EC)		Pa	110	110	110	110	110	110
Water connections								
Type			Male gas threaded BSPP ISO 228			Male gas threaded BSPP ISO 228		
Inlet - Outlet - diameter	Evaporator	Inch	2 ½ - 2 ½			2 ½ - 2 ½		
Inlet - Outlet - diameter	Desuperheater	Inch	1 ¼ - 1 ¼			1 ¼ - 1 ¼		

1) Data refers to 7 °C leaving chilled water temperature and 35 °C condenser air temperature, according EN14511 standard. 2) Following COMMISSION REGULATION (EU) No 2016/2281 for comfort application chillers. 3) Those are the data with variable flow. 4) Data refers to 45 °C leaving warm water temperature and 7 °C ambient coil air temperature with 87% R.H., according EN14511 standard. 5) Following COMMISSION REGULATION (EU) No 813/2013 for low-temperature heat pumps. 6) Sound pressure levels calculated at 10 meters. Sound pressure levels refer to ISO standard 3744 with parallel piped shape. * w: with, w/o: without.

Accessories	
PAW-SYSREMKIT1	Remote control
PAW-CM000SP041	Cloudgate Plug & Play IP65 box mobile 4G Europe
PAW-CM000K001	Remote antenna to improve signal coverage

Accessories	
PAW-00SRTS011	ECOi-W Cloud service fee. Prepaid subscription for 1 year
PAW-SYSSOV5	Shut off valves kit for model 85 - 170



Options for R32 outdoor units

Options table 50 - 85

Option	Type	Ref.	Description	Model				
				50	60	70	75	85
1	Capacity							
2	Refrigerant, fan and compressor type	Q	R32, AC fan, fixed speed compressor - cooling only	•	•	•	•	•
		R	R32, EC fan, fixed speed compressor - cooling only	•	•	•	•	•
		S	R32, high pressure EC fan, fixed speed compressor - cooling only	•	•	•	•	•
		M	R32, AC fan, fixed speed compressor - heat pump	•	•	•	•	•
		N	R32, EC fan, fixed speed compressor - heat pump	•	•	•	•	•
		O	R32, high pressure EC fan, fixed speed compressor - heat pump	•	•	•	•	•
3	Buffer tank option	NB	No buffer	Std	Std	Std	Std	Std
		BM	Buffer tank (medium)	•	•	•	•	
		BL	Buffer tank (large)					•
4	Pump option		No pump	Std	Std	Std	Std	Std
			Single pump low pressure	•	•	•	•	•
			Single pump high pressure	•	•	•	•	•
			Double pump low pressure	•	•	•	•	•
			Double pump high pressure	•	•	•	•	•
5	Pump drive option		Pump drive - fixed speed	Std	Std	Std	Std	Std
			Pump drive - variable twin speed (single pump)	•	•	•	•	•
			Pump drive - variable twin speed (double pump)	•	•	•	•	•
			Pump drive - constant outlet pressure (single pump)	•	•	•	•	•
			Pump drive - constant outlet pressure (double pump)	•	•	•	•	•
6	Hydraulic options		Flow switch	Std	Std	Std	Std	Std
			Low water pressure sensor ¹⁾	•	•	•	•	•
			Desuperheater	•	•	•	•	•
			Water isolation valves	•	•	•	•	•
7	Control options		Standard BMS option (Modbus RTU)	Std	Std	Std	Std	Std
			Modbus TCP/IP	Std	Std	Std	Std	Std
			BACnet MSTP	Std	Std	Std	Std	Std
			BACnet IP	Std	Std	Std	Std	Std
			Digital input for: Cooling/heating or Night mode or Load Shedding	Std	Std	Std	Std	Std
8	Electrical options		Automatic circuit breaker	Std	Std	Std	Std	Std
			Phase sequence control	Std	Std	Std	Std	Std
			Fan speed controller	•	•	•	•	•
			Power supply w neutral ²⁾	S0	S0	S0	S0	S0
			Electrical backup heater 12 kW - heat pump ³⁾	•	•	•	•	
			Electrical backup heater 24 kW - heat pump ³⁾	•	•	•	•	
			Electrical backup heater 36 kW - heat pump ³⁾					•
9	Refrigerant options		Soft starter	•	•	•	•	•
			Electronic expansion valve	Std	Std	Std	Std	Std
10	Ambient options		Refrigerant gauges (HP and LP manometers)	•	•	•	•	•
			Aluminium finned coil - cooling only	Std	Std	Std	Std	Std
			Bluefin coil treatment - heat pump	Std	Std	Std	Std	Std
			Finned coil treatment - epoxy	•	•	•	•	•
			Finned coil Blygold treatment	S0	S0	S0	S0	S0
			Outdoor coil protection grid	•	•	•	•	•
			Rubber pads (supplied loose)	•	•	•	•	•
			Spring damper (supplied loose)	•	•	•	•	•
			Container transport	•	•	•	•	•
			Acoustically insulating compressor jacket	•	•	•	•	•

1) Low water pressure sensor is supplied loose when selected as an option without pump and hydraulic kit. To be installed on site.

2) Systems are supplied without neutral terminal as standard, please contact local sales representative.

3) Electrical backup heaters can only be selected when combined with buffer tank option.

Std: Standard item included.

•: Optional item that can be selected.

S0: Special order item.

Options table 100 - 170

Option	Type	Ref.	Description	Model				
				100	115	130	150	170
1	Capacity							
2	Refrigerant, fan and compressor type	Q	R32, AC fan, fixed speed compressor - cooling only	•	•	•	•	•
		R	R32, EC fan, fixed speed compressor - cooling only	•	•	•	•	•
		S	R32, high pressure EC fan, fixed speed compressor - cooling only	•	•	•	•	•
		M	R32, AC fan, fixed speed compressor - heat pump	•	•	•	•	•
		N	R32, EC fan, fixed speed compressor - heat pump	•	•	•	•	•
		O	R32, high pressure EC fan, fixed speed compressor - heat pump	•	•	•	•	•
3	Buffer tank option	NB	No buffer	Std	Std	Std	Std	Std
		BL	Buffer tank (large)	•	•	•	•	•
4	Pump option		No pump ¹⁾	Std	Std	Std	Std	Std
			Single pump low pressure	•	•	•	•	•
			Single pump high pressure	•	•	•	•	•
			Double pump low pressure	•	•	•	•	•
			Double pump high pressure	•	•	•	•	•
			Pump drive - fixed speed ²⁾	Std	Std	Std	Std	Std
5	Pump drive option		Pump drive - variable twin speed (single pump)	•	•	•	•	•
			Pump drive - variable twin speed (double pump)	•	•	•	•	•
			Pump drive - constant outlet pressure (single pump)	•	•	•	•	•
			Pump drive - constant outlet pressure (double pump)	•	•	•	•	•
			Flow switch	Std	Std	Std	Std	Std
6	Hydraulic options		Low water pressure sensor ¹⁾	•	•	•	•	•
			Desuperheater	•	•	•	•	•
			Water isolation valves	•	•	•	•	•
7	Control options		Standard BMS option (Modbus RTU)	Std	Std	Std	Std	Std
			Modbus TCP/IP	Std	Std	Std	Std	Std
			BACnet MSTP	Std	Std	Std	Std	Std
			BACnet IP	Std	Std	Std	Std	Std
			Digital input for: Cooling/heating or Night mode or Load Shedding	Std	Std	Std	Std	Std
8	Electrical options		Automatic circuit breaker	Std	Std	Std	Std	Std
			Phase sequence control	Std	Std	Std	Std	Std
			Power supply w neutral ²⁾	S0	S0	S0		
			Power factor correction capacitors				•	•
			Electrical backup heater 24 kW - heat pump ³⁾	•	•	•		
			Electrical backup heater 36 kW - heat pump ³⁾	•	•	•		
			Soft starter	•	•	•	•	•
9	Refrigerant options		Electronic expansion valve	Std	Std	Std	Std	Std
			Refrigerant gauges (HP and LP manometers)	•	•	•	•	•
			Aluminium finned coil - cooling only	Std	Std	Std	Std	Std
			Bluefin coil treatment - heat pump	Std	Std	Std	Std	Std
			Finned coil treatment - epoxy	•	•	•	•	•
			Finned coil Blygold treatment	S0	S0	S0	S0	S0
10	Ambient options		Outdoor coil protection grid	•	•	•	•	•
			Rubber pads (supplied loose)	•	•	•	•	•
			Spring damper (supplied loose)	•	•	•	•	•
			Container transport	•	•	•	•	•
			Acoustically insulating compressor jacket	•	•	•	•	•

1) Low water pressure sensor is supplied loose when selected as an option without pump and hydraulic kit. To be installed on site.

2) Systems are supplied without neutral terminal as standard, please contact local sales representative.

3) Electrical backup heaters can only be selected when combined with buffer tank option.

Std: Standard item included.

•: Optional item that can be selected.

S0: Special order item.

ECOi-W R410A, the solution for hotels, offices and industry

ECOi-W provides the optimal performance in any climate.



1 High energy saving and comfort

- High SEER / SCOP
- Quiet operation
- Integration with ECOi VRF systems via BMS control
- Centralized remote management system

3 High quality

- Defrost limiting coil design (140 to 210 kW)
- Optimised design for service and maintenance
- Compact footprint

2 High flexibility

- Capacity range from 20 to 210 kW
- Customisable design
- Operating range: -17 °C (heating) to 50 °C (cooling)
- Wide range of hydraulic options
- Wide range of communication protocols

Operating conditions

Panasonic ECOi-W provides a wide operating range from -17 °C in heating to 50 °C in cooling.

Water outlet temperature in cooling.

A fluid outlet temperature of -10 °C in cooling offers uniqueness to the ECOi-W Series, which can ensure the operating temperature for process equipment in factories.

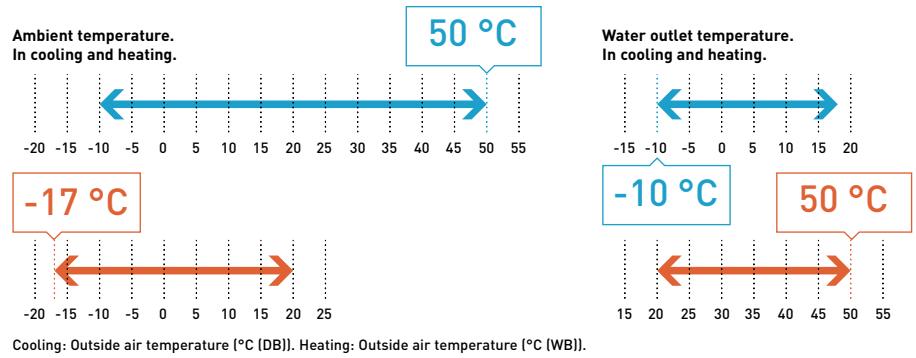

ECOi-W R410A line-up

ECOi-W R410A size		20	25	30	35	40	140	150	170	190	210
Cooling only range	Cooling capacities (kW)	19,2	24,3	27,1	36,7	39,0	132,0	146,0	164,0	181,0	208,8
	SEER	4,78	4,38	4,43	4,43	4,48	4,40	4,45	4,38	4,40	4,25
	ECOi-W R410A size	20	25	30	35	40	140	150	170	190	210
Heat pump range	Cooling capacities (kW)	18,7	23,7	26,4	35,8	38,1	128,3	142,1	163,9	177,5	207,9
	Heating capacities (kW)	19,5	26,9	29,7	37,3	41,6	144,0	154,0	170,0	195,0	218,0
	SEER ¹⁾	4,68	4,31	4,28	4,25	4,33	4,39	4,36	4,31	4,23	4,28
	SCOP ¹⁾	3,50	3,38	3,45	3,50	3,50	3,30	3,33	3,30	3,28	3,23
	Energy efficiency class (heating) ^{1) 2)}	A ⁺	A ⁺	A ⁺	A ⁺	A ⁺	—	—	—	—	—
Dimension (HxWxD)	1983x1000x1000		1983x1000x1000		2295x2856x2210		2321x2856x2210				

1) Those are the data with variable flow. 2) Following Eurovent and COMMISSION REGULATION (EU) No 811/2013 for low-temperature heat pumps. Scale from A+++ to D, as of 26th September 2019.

Panasonic Certified Quality

Panasonic does not compromise on product quality, safety or durability, providing the ultimate comfort when you need it most.



Class A pump

Units can be equipped with an efficient pump. A wide range of single and double pump, plus pump drive option is available.

Axial AC

The microprocessor control automatically adjusts the fan speed as a function of the operating conditions.

BP heat exchanger

Very compact & long durability Braze Plate Heat Exchanger. Unique design for the size 140 - 210 improving frost protection and efficiency.



Model type supplied may vary.

Energy recovery

The "Desuperheater" option consists of a stainless-steel braze plate heat exchanger which is mounted in series between the compressors and the air-cooled condenser. It can supply hot water up to 50°C free-of-charge while operating in the cooling mode, thanks to the partial recovery of condensation heat that would otherwise be rejected to the external heat source. The unit's efficiency is increased as condensing pressure can be reduced due to air cooled condenser becoming oversized.

* Available on special order only.

Simple user friendly control

In addition to basic control functions...

- Intelligent logic control for inlet water temperature
- Night setback operation to reduce electrical consumption and noise
- Automatic test operation at the push of a button



BMS integration

Modbus RTU as standard. Modbus TCP/IP, BACnet IP and BACnet MSTP as optional availability. Integrated systems with ECOi-W Chiller, VRF and BMS control can be offered.

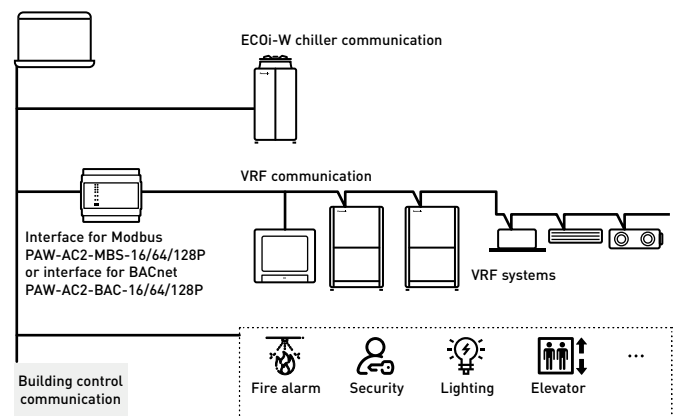
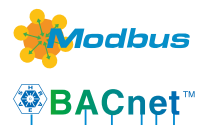



+22% more heating
+15% higher COP
SCOP improved

Defrost limiting coil design

- Fin space increased to prevent the coil freezing
- Number of rows increased to maintain the same capacity in standard conditions
- Designed to decrease freezing frequency as soon as outdoor air temperature goes below 7 °C

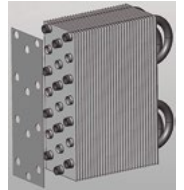

* Available in heat pump range size 140-210.

Standard coil: 2 defrost cycles every 130 min.

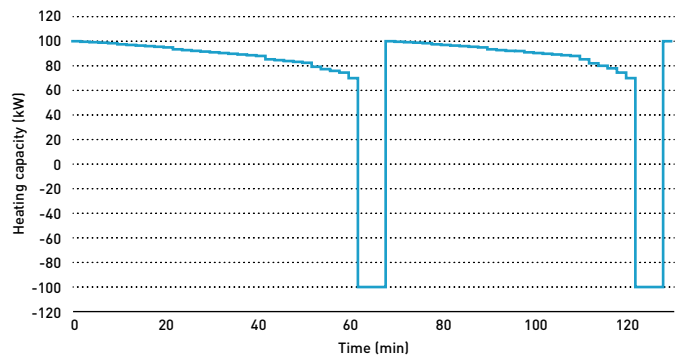

Special coil design: 1 defrost cycle every 130 min.

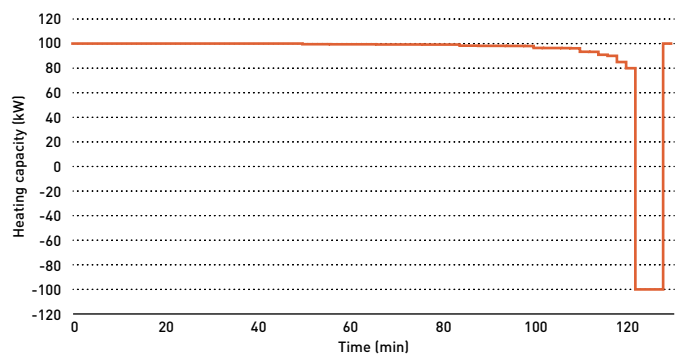

Victaulic® grooved connection

Victaulic® Installation-Ready™ couplings assure proper piping installation. Optimised design to reduce installation effects, including noise and vibration attenuation.



Model type supplied may vary.

* Available in 140-210.
 ** Threaded Victaulic® connection kit (PAW-SYSVICTH) is optional.

Bluefin for more durability

Bluefin hydrophilic coating improves defrost performance and reduces damage for a longer life time.



* Available in heat pump range.

Low noise

ECOi-W series is equipped with the compressor phonic insulation box as a standard.

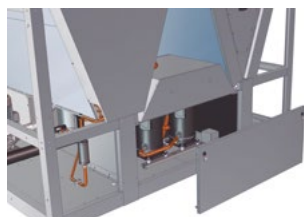

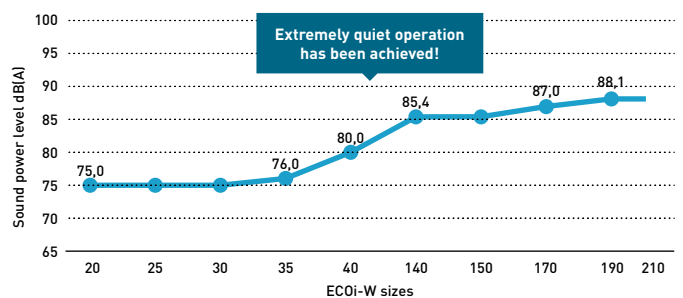

ECOi-W quiet operation in full range.



* Performance with standard fans.

Range of ECOi-W R410A outdoor units

Page	Outdoor units	20 kW	25 kW	30 kW	35 kW	40 kW
	ECOi-W R410A 20 to 40					
P. 444	Cooling only	U-020CVNB U-020CVBS	U-025CVNB U-025CVBS	U-030CVNB U-030CVBS	U-035CVNB U-035CVBS	U-040CVNB U-040CVBS
P. 448	Heat pump	U-020CWNB U-020CWBS	U-025CWNB U-025CWBS	U-030CWNB U-030CWBS	U-035CWNB U-035CWBS	U-040CWNB U-040CWBS

ECOi-W R410A 140 to 210

P. 446 Cooling only

P. 450 Heat pump



140 kW

150 kW

170 kW

190 kW

210 kW



U-140CVNB
U-140CVBL

U-150CVNB
U-150CVBL

U-170CVNB
U-170CVBL

U-190CVNB
U-190CVBL

U-210CVNB
U-210CVBL

U-140CWNB
U-140CWBL

U-150CWNB
U-150CWBL

U-170CWNB
U-170CWBL

U-190CWNB
U-190CWBL

U-210CWNB
U-210CWBL



U - 020/025/030/035/040 CV

Cooling capacity: 19,2 to 39,0 kW

Compact and highly efficient chiller series, with SEER up to 4,78.



- High seasonal efficiency
- Ambient temperature operating range: -10 to +50 °C
- Water outlet temperature range: -10 to +18 °C
- Super quiet operation
- Optimised design for service and maintenance
- Simple user friendly control as standard
- Modbus RTU as standard

Technical focus

- Chiller type: cooling only
- Compressor type (number): Scroll compressors (2)
- Refrigerant type: R410A
- Refrigerant circuit: 1
- Fan type (number): axial fan (1)
- Heat exchanger: stainless steel plate heat exchanger
- Flow switch, water safety and air purge valves included
- Water filter included (mandatory to be installed on site)
- Night mode setting to save energy and reduce noise level
- Water compensation curve control

Ambient temperature.

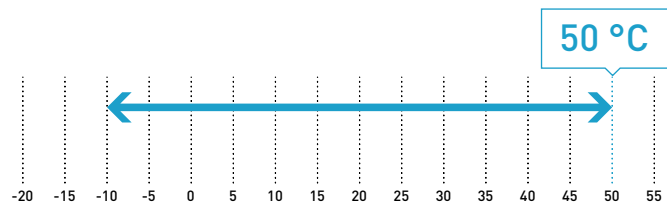

Water outlet temperature.

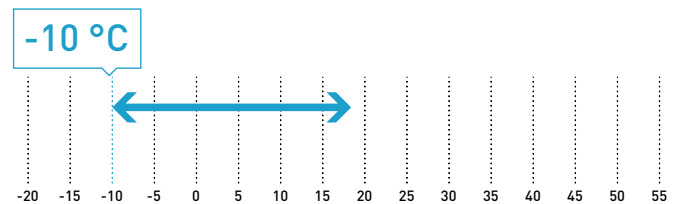

Cooling: Outside air temperature (°C [DB]).

Available options

Options	Pump drive	Hydraulic options	Ambient options	Miscellaneous options
Single pump (as standard)	Fixed speed ¹⁾	Low water pressure sensor	Finned coil treatment - epoxy	Soft starter
	Variable twin speed	Water isolation valves	Rubber pads	Power supply w/o neutral
	Constant outlet pressure		Spring damper	Modbus TCP/IP
	Constant differential pressure		All seasons	BACnet MSTP
			High pressure fan ²⁾	BACnet IP

1) Available for non-EU installation. 2) Available on models 25 - 40.



+ REFER TO PAGE 452 TO SEE MORE OPTIONS FOR R410A OUTDOOR UNITS



Optional controller.
PAW-SYSREMKIT



Optional Shut off valves
kit for model 20 - 40.
PAW-SYSSOV1

Model		20	25	30	35	40	
Standard without buffer tank		U-020CVNB	U-025CVNB	U-030CVNB	U-035CVNB	U-040CVNB	
With buffer tank		U-020CVBS	U-025CVBS	U-030CVBS	U-035CVBS	U-040CVBS	
Power supply	Voltage	V	400	400	400	400	
	Phase		Three phase	Three phase	Three phase	Three phase	
	Frequency	Hz	50	50	50	50	
Cooling capacity ¹⁾		kW	19,2	24,3	27,1	36,7	39,0
Input power ¹⁾		kW	5,9	7,7	9,3	12,2	13,0
Total EER 100% ¹⁾			3,25	3,17	2,90	3,01	3,00
SEER ²⁾			4,78	4,38	4,43	4,43	4,48
$\eta_{s,c}$ ²⁾		%	188	172	174	174	176
Startup type			Direct	Direct	Direct	Direct	Direct
Maximum operating current		A	17,7	22,2	24,3	31,8	33,8
Startup current w/o / w softstarter		A	53/28	64/35	77/49	118/53	119/54
Sound power (w standard fans)		dB(A)	75,0	75,0	75,0	76,0	76,0
Sound pressure (w standard fans) ³⁾		dB(A)	42,8	42,8	42,8	43,8	43,8
Dimension (w standard fans) w/o buffer	H x W x D	mm	1983 x 1000 x 1000	1983 x 1000 x 1000	1983 x 1000 x 1000	1983 x 1000 x 1000	1983 x 1000 x 1000
Dimension (w standard fans) w buffer	H x W x D	mm	1983 x 1000 x 1507	1983 x 1000 x 1507	1983 x 1000 x 1507	1983 x 1000 x 1507	1983 x 1000 x 1507
Weight (w 1 pump) w/o buffer		kg	265	275	305	315	320
Weight (w 1 pump) w buffer		kg	330	340	370	380	385
Refrigerant (R410A)		kg	6,5	8,4	8,4	9,1	9,2
Number of refrigerant circuit			1	1	1	1	1
Compressors							
Number			2	2	2	2	2
Type			Scroll	Scroll	Scroll	Scroll	Scroll
Part load step	%		0/50/100	0/50/100	0/50/100	0/50/100	0/50/100
Crankcase heater	W		2 x 40	2 x 40	2 x 49	2 x 49	2 x 49
Evaporator							
Number			1	1	1	1	1
Type			Plate	Plate	Plate	Plate	Plate
Nominal water flow	Cool	m ³ /h	3,35	4,36	4,64	6,16	6,44
Water pressure drop	Cool	kPa	23	37	22	37	40
Water volume		l	1,78	1,78	2,55	2,55	2,55
Antifreeze heater	W		30	30	30	30	30
Coils							
Number			1	1	1	1	1
Frontal surface		m ²	2,4	2,4	2,4	2,8	2,8
Number of rows			2	2	2	2	2
Fans standard							
Number			1	1	1	1	1
Air flow		m ³ /h	9000	13000	13000	16000	16000
Rotation speed		r.p.m.	900	900	900	650	650
Input power (each fan)		kW	0,6	0,9	0,9	0,9	0,9
Water connections							
Type			Male gas threaded BSPP ISO 228	Male gas threaded BSPP ISO 228	Male gas threaded BSPP ISO 228	Male gas threaded BSPP ISO 228	Male gas threaded BSPP ISO 228
Inlet - diameter	Inch		1 ½	1 ½	1 ½	1 ½	1 ½
Outlet - diameter	Inch		1 ½	1 ½	1 ½	1 ½	1 ½

1) Data refers to 7 °C leaving chilled water temperature and 35 °C condenser air temperature, according EN14511 standard. 2) Following COMMISSION REGULATION (EU) No 2016/2281 for comfort application chillers. 3) Sound pressure levels calculated at 10 meters. Sound pressure levels refer to ISO standard 3744 with parallel piped shape.
* w: with, w/o: without. ** The data are calculated with variable flow.

Accessories	
PAW-SYSREMKIT	Remote control
PAW-CM000SP041	Cloudgate Plug & Play IP65 box mobile 4G Europe
PAW-CM000K001	Remote antenna to improve signal coverage

Accessories	
PAW-00SRTS011	ECOi-W Cloud service fee. Prepaid subscription for 1 year
PAW-SYSSOV1	Shut off valves kit for model 20 - 40





U - 140/150/170/190/210 CV

Cooling capacity: 132,0 to 208,0 kW

Powerful and efficient operation with 4 scroll compressors and superior flexibility with Plug & Play hydraulic options.



- High seasonal efficiency
- Ambient temperature operating range: -10 to +50 °C
- Water outlet temperature range: -10 to +18 °C
- Super quiet operation
- Victaulic® water connections
- Optimised design for service and maintenance
- Simple user friendly control as standard
- Modbus RTU as standard
- Modbus TCP/IP as standard

Technical focus

- Chiller type: cooling only
- Compressor type (number): Scroll compressors (4)
- Refrigerant type: R410A
- Refrigerant circuit: 2
- Fan type (number): axial fan (4)
- Heat exchanger: stainless steel plate heat exchanger
- Flow switch, water safety and air purge valves included
- Water filter included (mandatory to be installed on site)
- Night mode setting to save energy and reduce noise level
- Water compensation curve control
- Remote LAN connection as standard

Ambient temperature.

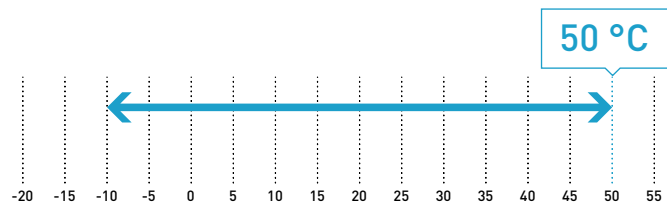

Cooling: Outside air temperature (°C [DB]).

Water outlet temperature.

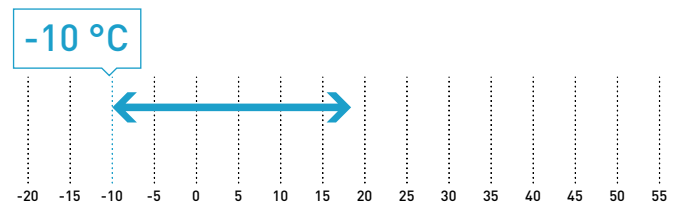

Available options

Options				
Pump	Pump drive	Hydraulic options	Ambient options	Miscellaneous options
Single pump low pressure	Fixed speed ¹⁾	Low water pressure sensor	Finned coil treatment - epoxy	Soft starter
Single pump high pressure	Variable twin speed	Water isolation valves	Outdoor coil protection grid	Power supply w/o neutral
Double pump low pressure	Variable capacity	Hydraulic gauges	Rubber pads	Modbus TCP/IP
Double pump high pressure	Constant outlet pressure		Spring damper	BACnet IP
	Constant differential pressure		All seasons fan control	Container transport
			High pressure fan ²⁾	Refrigerant gauge

1) Available for non-EU installation. 2) Available on special order only, please contact your local Panasonic sales representative



+ REFER TO PAGE 452 TO SEE MORE OPTIONS FOR R410A OUTDOOR UNITS

Optional controller.
PAW-SYSREMKIT

Model			140	150	170	190	210
Standard without buffer tank			U-140CVNB	U-150CVNB	U-170CVNB	U-190CVNB	U-210CVNB
With buffer tank			U-140CVBL	U-150CVBL	U-170CVBL	U-190CVBL	U-210CVBL
Power supply	Voltage	V	400	400	400	400	400
	Phase		Three phase	Three phase	Three phase	Three phase	Three phase
	Frequency	Hz	50	50	50	50	50
Cooling capacity ¹⁾		kW	132,0	146,0	164,0	181,0	208,0
Input power ¹⁾		kW	43,1	47,6	54,8	61,1	69,8
Total EER 100% ¹⁾			3,06	3,07	2,99	2,96	2,98
SEER ²⁾			4,40	4,45	4,38	4,40	4,25
$\eta_{s,c}$ ²⁾		%	173	175	172	173	167
Startup type			Direct	Direct	Direct	Direct	Direct
Maximum operating current		A	108,0	119,0	136,0	153,0	170,0
Startup current w/o / w softstarter		A	251/130	262/141	324/161	341/178	396/201
Sound power (w standard fans)		dB(A)	85,4	85,4	87,0	88,1	88,1
Sound pressure (w standard fans) ³⁾		dB(A)	53,4	53,4	55,0	56,1	56,1
Dimension (w standard fans) w/o buffer	H x W x D	mm	2295 x 2856 x 2210	2295 x 2856 x 2210	2295 x 2856 x 2210	2295 x 2856 x 2210	2295 x 2856 x 2210
Dimension (w standard fans) w buffer	H x W x D	mm	2295 x 3666 x 2210	2295 x 3666 x 2210	2295 x 3666 x 2210	2295 x 3666 x 2210	2295 x 3666 x 2210
Weight (w 1 low Pa pump) w/o buffer		kg	1510	1520	1610	1680	1940
Weight (w 1 low Pa pump) w buffer		kg	1640	1650	1740	1810	2070
Refrigerant (R410A)		kg	2 x 24,7	2 x 24,7	24,7/33,3	2 x 33,3	2 x 33,3
Number of refrigerant circuit			2	2	2	2	2
Compressors							
Number			4	4	4	4	4
Type			Scroll	Scroll	Scroll	Scroll	Scroll
Part load step		%	0 / 24 / 26 / 48 / 50 / 52 / 74 / 76 / 100	0 / 23 / 27 / 46 / 50 / 54 / 73 / 77 / 100	0 / 20 / 24 / 44 / 45 / 55 / 69 / 80 / 100	0 / 22 / 28 / 44 / 50 / 56 / 72 / 78 / 100	0 / 19 / 31 / 38 / 50 / 62 / 69 / 81 / 100
Crankcase heater		W	4 x 66	4 x 66	3 x 66/82	2 x 82/2 x 66	2 x 95/2 x 66
Evaporator							
Number			1	1	1	1	1
Type			Plate	Plate	Plate	Plate	Plate
Nominal water flow	Cool	m ³ /h	21,56	23,65	25,95	30,24	33,62
Water pressure drop	Cool	kPa	33	39	24	32	40
Water volume		l	8,49	8,49	12,21	12,21	12,21
Antifreeze heater		W	60	60	120	120	120
Coils							
Number			4	4	4	4	4
Frontal surface		m ²	11,88	11,88	11,88	11,88	11,88
Number of rows			2+2	2+2	2+3	3+3	3+3
Fans standard							
Number			4	4	4	4	4
Air flow		m ³ /h	56000	56000	71000	86000	83000
Rotation speed		r.p.m.	900	900	900	900	900
Input power (each fan)		kW	0,9	0,9	0,9 - 1,7	1,7	1,7
Water connections							
Type			Victaulic®	Victaulic®	Victaulic®	Victaulic®	Victaulic®
Inlet - diameter		Inch	2 ½	2 ½	2 ½	2 ½	2 ½
Outlet - diameter		Inch	2 ½	2 ½	2 ½	2 ½	2 ½

1) Data refers to 7 °C leaving chilled water temperature and 35 °C condenser air temperature, according EN14511 standard. 2) Following COMMISSION REGULATION (EU) No 2016/2281 for comfort application chillers. 3) Sound pressure levels calculated at 10 meters. Sound pressure levels refer to ISO standard 3744 with parallel piped shape.

* w: with, w/o: without. ** The data are calculated with variable flow.

Accessories

PAW-SYSREMKIT	Remote control
PAW-CM000SP041	Cloudgate Plug & Play IP65 box mobile 4G Europe
PAW-CM000K001	Remote antenna to improve signal coverage

Accessories

PAW-00SRTS011	ECOi-W Cloud service fee. Prepaid subscription for 1 year
PAW-SYSVICTH	Victaulic® connection kit for model 140 - 210





U - 020/025/030/035/040 CW

Cooling capacity: 18,7 to 38,1 kW

Heating capacity: 19,5 to 41,6 kW

Compact and powerful heat pump chiller series with Panasonic quality verification.

ECOi-W Series guarantees quiet operation.



- High seasonal efficiency in cooling and heating
- Eurovent certified
- Ambient temperature operating range: -10 to +50 °C in cooling, -17 to +20 °C in heating
- Water outlet temperature range: -10 to +18 °C in cooling, +20 to +50 °C in heating
- Super quiet operation
- Optimised design for service and maintenance
- Simple user friendly control as standard
- Modbus RTU as standard

Technical focus

- Chiller type: heat pump
- Compressor type (number): Scroll compressors (2)
- Refrigerant type: R410A
- Refrigerant circuit: 1
- Fan type (number): axial fan (1)
- Heat exchanger: stainless steel plate heat exchanger
- Flow switch, water safety and air purge valves included
- Water filter included (mandatory to be installed on site)
- Night mode setting to save energy and reduce noise level
- Water compensation curve control
- Bluefin anti-corrosion coating

Ambient temperature.

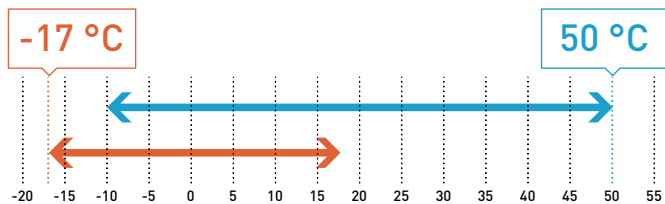

Cooling: Outside air temperature (°C [DB]). Heating: Outside air temperature (°C [WB]).

Water outlet temperature.

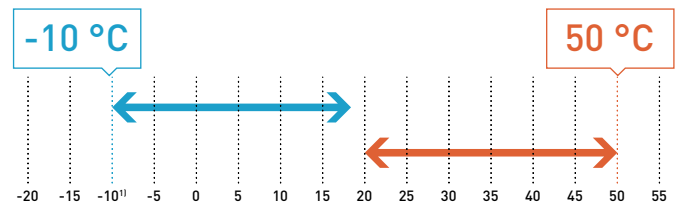

Available options

Options	Pump drive	Hydraulic options	Ambient options	Miscellaneous options
Single pump	Variable twin speed ¹⁾	Low water pressure sensor	Finned coil treatment - epoxy	Soft starter
	Constant outlet pressure	Water isolation valves	Rubber pads	Power supply w/o neutral
	Constant differential pressure		Spring damper	Modbus TCP/IP
			All seasons	BACnet MSTP
			Nordic pack	BACnet IP
			High pressure fan ²⁾	

1) Available as standard on models 35 - 40 when pump is selected. 2) Available as standard on models 20 - 30 when pump is selected.



+ REFER TO PAGE 452 TO SEE MORE OPTIONS FOR R410A OUTDOOR UNITS



Optional controller.
PAW-SYSREMKIT



Optional Shut off valves
kit for model 20 - 40.
PAW-SYSSOV1

Model			20	25	30	35	40
Standard without buffer tank			U-020CWNB	U-025CWNB	U-030CWNB	U-035CWNB	U-040CWNB
With buffer tank			U-020CWBS	U-025CWBS	U-030CWBS	U-035CWBS	U-040CWBS
Power supply	Voltage	V	400	400	400	400	400
	Phase		Three phase	Three phase	Three phase	Three phase	Three phase
	Frequency	Hz	50	50	50	50	50
Cooling capacity ¹⁾		kW	18,7	23,7	26,4	35,8	38,1
Input power ¹⁾		kW	5,9	7,7	9,4	12,3	13,1
Total EER 100% ¹⁾			3,15	3,07	2,81	2,92	2,91
SEER ^{2) 3)}			4,68	4,31	4,28	4,25	4,33
$\eta_{s,c}$ ^{2) 3)}		%	184	169	168	167	170
Heating capacity ⁴⁾		kW	19,5	26,9	29,7	37,3	41,6
Input power ⁴⁾		kW	6,1	9,3	9,9	13,2	13,5
SCOP ^{5) 5)}			3,50	3,38	3,45	3,50	3,50
$\eta_{s,h}$ ^{5) 5)}		%	137	132	135	137	137
Energy efficiency class (Scale A+++ to D) ⁶⁾			A+	A+	A+	A+	A+
Startup type			Direct	Direct	Direct	Direct	Direct
Maximum operating current		A	17,7	22,2	24,3	31,8	33,8
Startup current w/o / w softstarter		A	53/20	64/35	77/41	118/53	119/54
Sound power (w standard fans)		dB(A)	75,0	75,0	75,0	76,0	76,0
Sound pressure (w standard fans) ⁷⁾		dB(A)	42,8	42,8	42,8	43,8	43,8
Dimension (w standard fans) w/o buffer	HxWxD	mm	1983x1000x1000	1983x1000x1000	1983x1000x1000	1983x1000x1000	1983x1000x1000
Dimension (w standard fans) w buffer	HxWxD	mm	1983x1000x1507	1983x1000x1507	1983x1000x1507	1983x1000x1507	1983x1000x1507
Weight (w 1 pump) w/o buffer		kg	280	290	320	330	335
Weight (w 1 pump) w buffer		kg	345	355	385	395	400
Refrigerant (R410A)		kg	8,4	8,4	8,4	9,1	9,2
Number of refrigerant circuit			1	1	1	1	1
Compressors							
Number			2	2	2	2	2
Type			Scroll	Scroll	Scroll	Scroll	Scroll
Part load step		%	0/50/100	0/50/100	0/50/100	0/50/100	0/50/100
Crankcase heater		W	2x40	2x40	2x49	2x49	2x49
Evaporator							
Number			1	1	1	1	1
Type			Plate	Plate	Plate	Plate	Plate
Nominal water flow	Cool	m ³ /h	3,35	4,36	4,64	6,16	6,44
Water pressure drop	Cool	kPa	23	37	22	37	40
Water volume		l	1,78	1,78	2,55	2,55	2,55
Antifreeze heater		W	30	30	30	30	30
Coils							
Number			1	1	1	1	1
Frontal surface		m ²	2,4	2,4	2,4	2,8	2,8
Number of rows			2	2	2	2	2
Fans standard							
Number			1	1	1	1	1
Air flow		m ³ /h	9000	13000	13000	16000	16000
Rotation speed		r.p.m.	900	900	900	650	650
Input power (each fan)		kW	0,6	0,9	0,9	0,9	0,9
Water connections							
Type			Male gas threaded BSPP ISO 228	Male gas threaded BSPP ISO 228	Male gas threaded BSPP ISO 228	Male gas threaded BSPP ISO 228	Male gas threaded BSPP ISO 228
Inlet - diameter		Inch	1 1/2	1 1/2	1 1/2	1 1/2	1 1/2
Outlet - diameter		Inch	1 1/2	1 1/2	1 1/2	1 1/2	1 1/2

1) Data refers to 7 °C leaving chilled water temperature and 35 °C condenser air temperature, according EN14511 standard. 2) Following COMMISSION REGULATION (EU) No 2016/2281 for comfort application chillers. 3) Those are the data with variable flow. 4) Data refers to 45 °C leaving warm water temperature and 7 °C ambient coil air temperature with 87% R.H., according EN14511 standard. 5) Following COMMISSION REGULATION (EU) No 813/2013 for low-temperature heat pumps. 6) Following Eurovent and COMMISSION REGULATION (EU) No 811/2013 for low-temperature heat pumps. Scale from A+++ to D, as of 26th September 2019. 7) Sound pressure levels calculated at 10 meters. Sound pressure levels refer to ISO standard 3744 with parallel piped shape. * w: with, w/o: without.

Accessories

PAW-SYSREMKIT	Remote control
PAW-CM000SP041	Cloudgate Plug & Play IP65 box mobile 4G Europe
PAW-CM000K001	Remote antenna to improve signal coverage

Accessories

PAW-00SRTS011	ECOi-W Cloud service fee. Prepaid subscription for 1 year
PAW-SYSSOV1	Shut off valves kit for model 20 - 40

HIGH SEER 4,68	HIGH SCOP 3,50	ErP	SUPER QUIET	BLUEFIN	ULTIMATE CUSTOMISATION	AUTOMATIC FAN	-17 °C HEATING MODE	50 °C COOLING MODE	BMS CONNECTIVITY
--------------------------	--------------------------	------------	--------------------	----------------	-------------------------------	----------------------	----------------------------	---------------------------	-------------------------





U - 140/150/170/190/210 CW

Cooling capacity: 128,3 to 207,9 kW
Heating capacity: 144,0 to 218,0 kW

Heat pump chiller series with powerful operation by 4 scroll compressors. Maximum water outlet temperature in heating is up to 50 °C. Defrost limiting design ensures to provide stable hot water even at low ambient conditions.

1 defrost cycle every 130 minutes.
Heating Capacity: +22%
Integrated COP: +15%
Improved SCOP Class



- Smart defrost: Defrost limiting design to ensure a constant water outlet temperature even at very low temperatures
- High seasonal efficiency in cooling and heating
- Eurovent certified
- Ambient temperature operating range: -10 to +50 °C in cooling, -17 to +20 °C in heating
- Water outlet temperature range: -10 to +18 °C in cooling, +20 to +50 °C in heating
- Super quiet operation
- Victaulic® water connections
- Optimised design for service and maintenance
- Simple user friendly control as standard
- Modbus RTU as standard
- Modbus TCP/IP as standard

Technical focus

- Chiller type: heat pump
- Compressor type (number): Scroll compressors (4)
- Refrigerant type: R410A
- Refrigerant circuit: 2
- Fan type (number): axial fan (4)
- Heat exchanger: stainless steel plate heat exchanger
- Flow switch, water safety and air purge valves included
- Water filter included (mandatory to be installed on site)
- Night mode setting to save energy and reduce noise level
- Water compensation curve control
- Bluefin anti-corrosion coating
- Remote LAN connection as standard

Ambient temperature.

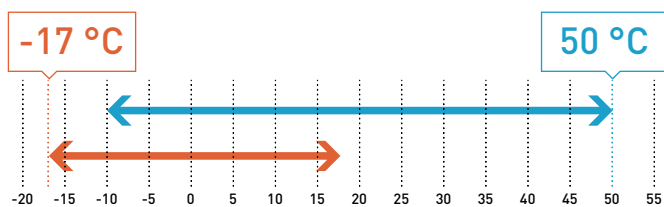

Cooling: Outside air temperature [°C (DB)]. Heating: Outside air temperature [°C (WB)].

Water outlet temperature.

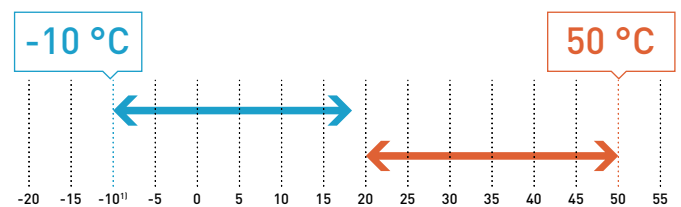

Available options

Options				
Pump	Pump drive	Hydraulic options	Ambient options	Miscellaneous options
Single pump low pressure	Fixed speed	Low water pressure sensor	Finned coil treatment - epoxy	Soft starter
Single pump high pressure	Variable twin speed	Desuperheater ¹⁾	Outdoor coil protection grid	Power supply w/o neutral
Double pump low pressure	Variable capacity	Water isolation valves	Rubber pads	Modbus TCP/IP
Double pump high pressure	Constant outlet pressure	Hydraulic gauges	Spring damper	BACnet IP
	Constant differential pressure		All seasons fan control	Container transport
			Nordic pack	Refrigerant gauge
			High pressure fan	

¹⁾ Available on special order only, please contact your local Panasonic sales representative.



+ REFER TO PAGE 452 TO SEE MORE OPTIONS FOR R410A OUTDOOR UNITS



Optional controller.
PAW-SYSREMKIT

Model			140	150	170	190	210
Standard without buffer tank			U-140CWNB	U-150CWNB	U-170CWNB	U-190CWNB	U-210CWNB
With buffer tank			U-140CWBL	U-150CWBL	U-170CWBL	U-190CWBL	U-210CWBL
Power supply	Voltage	V	400	400	400	400	400
	Phase		Three phase	Three phase	Three phase	Three phase	Three phase
	Frequency	Hz	50	50	50	50	50
Cooling capacity ¹⁾		kW	128,3	142,1	163,9	177,5	207,9
Input power ¹⁾		kW	43,2	47,7	54,7	61,3	69,7
Total EER 100% ¹⁾			2,97	2,98	2,99	2,90	2,98
SEER ^{2) 3)}			4,39	4,36	4,31	4,23	4,28
$\eta_{s,c}$ ^{2) 3)}		%	173	171	169	166	168
Heating capacity ⁴⁾		kW	144,0	154,0	170,0	195,0	218,0
Input power ⁴⁾		kW	45,7	50,3	55,5	67,4	78,3
SCOP ^{3) 5)}			3,30	3,33	3,30	3,23	3,23
$\eta_{s,h}$ ^{3) 5)}		%	129	130	129	128	126
Startup type			Direct	Direct	Direct	Direct	Direct
Maximum operating current		A	108,0	119,0	136,0	153,0	170,0
Startup current w/o / w softstarter		A	251/130	262/141	324/161	341/178	396/201
Sound power (w standard fans)		dB(A)	85,4	85,4	87,0	88,1	88,1
Sound pressure (w standard fans) ⁶⁾		dB(A)	53,4	53,4	55,0	56,1	56,1
Dimension (w standard fans) w/o buffer	H x W x D	mm	2295 x 2856 x 2210	2295 x 2856 x 2210	2295 x 2856 x 2210	2295 x 2856 x 2210	2295 x 2856 x 2210
Dimension (w standard fans) w buffer	H x W x D	mm	2295 x 3666 x 2210	2295 x 3666 x 2210	2295 x 3666 x 2210	2295 x 3666 x 2210	2295 x 3666 x 2210
Weight (w 1 low Pa pump) w/o buffer		kg	1570	1580	1680	1750	2020
Weight (w 1 low Pa pump) w buffer		kg	1700	1710	1810	1880	2150
Refrigerant (R410A)		kg	2 x 24,7	2 x 24,7	24,7/33,3	2 x 33,3	2 x 33,3
Number of refrigerant circuit			2	2	2	2	2
Compressors							
Number			4	4	4	4	4
Type			Scroll	Scroll	Scroll	Scroll	Scroll
Part load step		%	0 / 24 / 26 / 48 / 50 / 52 / 74 / 76 / 100	0 / 23 / 27 / 46 / 50 / 54 / 73 / 77 / 100	0 / 20 / 24 / 44 / 45 / 55 / 69 / 80 / 100	0 / 22 / 28 / 44 / 50 / 56 / 72 / 78 / 100	0 / 19 / 31 / 38 / 50 / 62 / 69 / 81 / 100
Crankcase heater		W	4 x 66	4 x 66	3 x 66/82	2 x 82/2 x 66	2 x 95/2 x 66
Evaporator							
Number			1	1	1	1	1
Type			Plate	Plate	Plate	Plate	Plate
Nominal water flow	Cool	m ³ /h	21,56	23,65	25,95	30,24	33,62
Water pressure drop	Cool	kPa	33	39	24	32	40
Water volume		l	8,49	8,49	12,21	12,21	12,21
Antifreeze heater		W	60	60	120	120	120
Coils							
Number			4	4	4	4	4
Frontal surface		m ²	11,88	11,88	11,88	11,88	11,88
Number of rows			2+2	2+2	2+3	3+3	3+3
Fans standard							
Number			4	4	4	4	4
Air flow		m ³ /h	56000	56000	71000	86000	83000
Rotation speed		r.p.m.	900	900	900	900	900
Input power (each fan)		kW	0,9	0,9	0,9 - 1,7	1,7	1,7
Water connections							
Type			Victaulic®	Victaulic®	Victaulic®	Victaulic®	Victaulic®
Inlet - diameter		Inch	2 ½	2 ½	2 ½	2 ½	2 ½
Outlet - diameter		Inch	2 ½	2 ½	2 ½	2 ½	2 ½

1) Data refers to 7 °C leaving chilled water temperature and 35 °C condenser air temperature, according EN14511 standard. 2) Following COMMISSION REGULATION (EU) No 2016/2281 for comfort application chillers. 3) Those are the data with variable flow. 4) Data refers to 45 °C leaving warm water temperature and 7 °C ambient coil air temperature with 87% R.H., according EN14511 standard. 5) Following COMMISSION REGULATION (EU) No 813/2013 for low-temperature heat pumps. 6) Sound pressure levels calculated at 10 meters. Sound pressure levels refer to ISO standard 3744 with parallel piped shape. * w: with, w/o: without.

Accessories	
PAW-SYSREMKIT	Remote control
PAW-CM000SP041	Cloudgate Plug & Play IP65 box mobile 4G Europe
PAW-CM000K001	Remote antenna to improve signal coverage

Accessories	
PAW-00SRTS011	ECOi-W Cloud service fee. Prepaid subscription for 1 year
PAW-SYSVICTH	Victaulic® connection kit for model 140 - 210

HIGH SEER
4,39

HIGH SCOP
3,33

ErP

SUPER QUIET

BLUEFIN

ULTIMATE CUSTOMISATION

AUTOMATIC FAN

HEATING MODE
-17 °C

COOLING MODE
50 °C

DEFROST LIMITING

BMS CONNECTIVITY



Options for R410A outdoor units

Options table 20 - 40

Option	Type	Ref.	Description	Model				
1	Capacity			20	25	30	35	40
2	Refrigerant and compressor type	V	R410A, fixed speed compressor - cooling only	•	•	•	•	•
		W	R410A, fixed speed compressor - heat pump	•	•	•	•	•
3	Buffer tank option	NB	No buffer	Std	Std	Std	Std	Std
		BS	Buffer tank (small)	•	•	•	•	•
		BM	Buffer tank (medium)					
4	Pump option		No pump ¹⁾	Std	Std	Std	Std	Std
			Single pump	•	•	•	•	•
			Double pump					
5	Pump drive option		Pump drive - fixed speed - cooling only ²⁾	•	•	•	•	•
			Pump drive - fixed speed - heat pump					
			Pump drive - variable twin speed (single pump) ³⁾	Std	Std	Std	Std	Std
			Pump drive - variable twin speed (double pump)					
			Pump drive - constant outlet pressure (single pump)	•	•	•	•	•
			Pump drive - constant outlet pressure (double pump)					
6	Hydraulic options		Pump drive - constant differential pressure (single pump) ⁴⁾	S0	S0	S0	S0	S0
			Flow switch	Std	Std	Std	Std	Std
			Low water pressure sensor ⁵⁾	•	•	•	•	•
			Water isolation valves	•	•	•	•	•
			Standard BMS option (Modbus RTU)	Std	Std	Std	Std	Std
7	Control options		Modbus TCP/IP	•	•	•	•	•
			BACnet MSTP	•	•	•	•	•
			BACnet IP	•	•	•	•	•
			Digital input for: Cooling/heating or Night mode or Load Shedding	Std	Std	Std	Std	Std
8	Electrical options		Automatic circuit breaker	Std	Std	Std	Std	Std
			Phase sequence control	Std	Std	Std	Std	Std
			Fan speed controller	•	•	•	•	•
			Electrical backup heater 12 kW - heat pump ⁶⁾					
			Electrical backup heater 24 kW - heat pump ⁶⁾					
			Electrical backup heater 36 kW - heat pump ⁶⁾					
			Power supply w/o neutral ⁷⁾	S0	S0	S0	S0	S0
9	Refrigerant options		Soft starter	•	•	•	•	•
			Refrigerant gauges (HP and LP manometers)					
			Aluminium finned coil - cooling only	Std	Std	Std	Std	Std
			Bluefin coil treatment - heat pump	Std	Std	Std	Std	Std
			Finned coil epoxy treatment	•	•	•	•	•
			Finned coil Blygold treatment	S0	S0	S0	S0	S0
10	Ambient options		Outdoor coil protection grid	•	•	•	•	•
			Rubber pads (supplied loose)	•	•	•	•	•
			Spring damper (supplied loose)	•	•	•	•	•
			Container transport					
			Low noise option	Std	Std	Std	Std	Std
			High pressure fan ⁸⁾	S0	•	•	•	•

1) The system may be supplied without a pump, but in order to meet EU ErP compliance, the installation must include a variable speed pump.

2) Fixed speed pump drive on cooling only chiller, is only suitable for installation outside of the EU due to ErP compliance.

3) Variable twin speed drive is supplied as standard with models 20 - 40, when selecting single pump option. Please select alternate pump drive if required.

4) Constant differential pump drive option is only available on a special order basis, and requires additional production time. Please contact your local sales representative.

5) Low water pressure sensor is supplied loose when selected as an option without pump and hydraulic kit. To be installed on site.

6) Electrical backup heaters can only be selected when combined with buffer tank option.

7) Power supply without neutral is only available on a special order and requires additional production time. Please contact your local sales representative.

8) High pressure fan is not available on model 20 due to body design.

Std: Standard item included.

•: Optional item that can be selected.

S0: Special order item.

Options table 140 - 210

Option	Type	Ref.	Description	Model				
				140	150	170	190	210
1	Capacity							
2	Refrigerant and compressor type	V	R410A, fixed speed compressor - cooling only	•	•	•	•	•
		W	R410A, fixed speed compressor - heat pump	•	•	•	•	•
3	Buffer tank option	NB	No buffer	Std	Std	Std	Std	Std
		BL	Buffer tank (large)	•	•	•	•	•
4	Pump option		No pump ¹⁾	Std	Std	Std	Std	Std
			Single pump low pressure	•	•	•	•	•
			Single pump high pressure	•	•	•	•	•
			Double pump low pressure	•	•	•	•	•
			Double pump high pressure	•	•	•	•	•
5	Pump drive option		Pump drive - fixed speed ²⁾	Std	Std	Std	Std	Std
			Pump drive - variable twin speed (single pump)	•	•	•	•	•
			Pump drive - variable twin speed (double pump)	•	•	•	•	•
			Pump drive - variable capacity (single pump)	•	•	•	•	•
			Pump drive - variable capacity (double pump)	•	•	•	•	•
			Pump drive - constant outlet pressure (single pump)	•	•	•	•	•
			Pump drive - constant outlet pressure (double pump)	•	•	•	•	•
			Pump drive - constant differential pressure (single pump) ³⁾	S0	S0	S0	S0	S0
	Pump drive - constant differential pressure (double pump) ³⁾	S0	S0	S0	S0	S0		
6	Hydraulic options		Flow switch	Std	Std	Std	Std	Std
			Low water pressure sensor ⁴⁾	•	•	•	•	•
			Water isolation valves	•	•	•	•	•
			Desuperheater	S0	S0	S0	S0	S0
			Hydraulic gauges	•	•	•	•	•
7	Control options		Standard BMS option (Modbus RTU)	Std	Std	Std	Std	Std
			Modbus TCP/IP	Std	Std	Std	Std	Std
			BACnet MSTP	•	•	•	•	•
			BACnet IP	•	•	•	•	•
			Digital input for: Cooling/heating or Night mode or Load Shedding	Std	Std	Std	Std	Std
8	Electrical options		Automatic circuit breaker	Std	Std	Std	Std	Std
			Phase sequence control	Std	Std	Std	Std	Std
			Fan speed controller	•	•	•	•	•
			Power supply w/o neutral	•	•	•	•	•
			Soft starter	•	•	•	•	•
9	Refrigerant options		Refrigerant gauges (HP and LP manometers)	•	•	•	•	•
			Aluminium finned coil - cooling only	Std	Std	Std	Std	Std
			Bluefin coil treatment - heat pump	Std	Std	Std	Std	Std
			Finned coil treatment - epoxy	•	•	•	•	•
			Finned coil Blygold treatment	S0	S0	S0	S0	S0
10	Ambient options		Outdoor coil protection grid	•	•	•	•	•
			Rubber pads (supplied loose)	•	•	•	•	•
			Spring damper (supplied loose)	•	•	•	•	•
			Container transport	•	•	•	•	•
			Low noise option	Std	Std	Std	Std	Std
			High pressure fan	S0	S0	S0	S0	S0

1) The system may be supplied without a pump, but in order to meet EU ErP compliance, the installation must include a variable speed pump.

2) Fixed speed pump drive on cooling only chiller, is only suitable for installation outside of the EU due to ErP compliance.

3) Constant differential pump drive option is only available on a special order basis, and requires additional production time. Please contact your local sales representative.

4) Low water pressure sensor is supplied loose when selected as an option without pump and hydraulic kit. To be installed on site.

Std: Standard item included.

•: Optional item that can be selected.

S0: Special order item.

Explore the range of fan coils. Designed to fit with your environment and enhance comfort

Designed to provide performance, comfort and seamless integration within your environment.



Fan coils highlighted features.
Available in a wide range of designs, the fan coils are perfectly adapted to fit within almost any location.



1 Innovation for an optimum comfort
Range of fan coils for heating and cooling with capacities from 0,5 to 21,9 kW in cooling and from 0,6 to 21,5 kW in heating. Bring full year comfort with hydronic systems.

3 Quality and efficient coil
Constructed from staggered copper tubes, mechanically expanded into aluminium fins, providing maximum heat transfer efficiency, durability and hygiene.

2 Energy efficient and low noise fan
Dynamically balanced and specially designed fans, reinforced acoustic insulation and optimised fan speed staging for lower noise levels. Improved efficiency with optional EC fan motor.

4 Flexible installation
Various types of unit to fit your needs with flexible installation options. A choice of service side for hydraulic connections, piping configuration and horizontal or vertical installation for ducted units.

Offering a great range of capacities and performance, available in a wide range of designs, the fan coils are perfectly adapted to fit within almost any location. Whether the requirements are for cooling only, or for both heating and cooling, there is a fan coil to suit. With a variety of piping and fan configuration, the range is capable of meeting the most stringent of requirements. Line up available in AC and EC fans, it is possible to achieve both powerful performance, but with sustainability in mind.

Controllers with sophisticated designs, provide a user friendly interface while enabling an easy and low cost integration to building management systems.

Optional wired remote controller for AC fan, 2-pipe and 4-pipe application.



PAW-FC-RC1

Optional wired remote controller for AC fan 2-pipe application.



PAW-FC-903AC



PAW-FC-907AC

Optional wired remote controller for EC fan, 2-pipe and 4-pipe application.



PAW-FC-903EC



PAW-FC-907EC

Range of fan coils

Page	Fan type	Operation	Capacity range	0 kW	1 kW	2 kW	3 kW	4 kW	
P. 458	Ducted	AC	Cooling	0,7 to 8,1 kW	[Blue bar]				
			Heating	0,7 to 10,3 kW	[Orange bar]				
	EC	Cooling	0,5 to 9,6 kW	[Blue bar]					
		Heating	0,6 to 13,6 kW	[Orange bar]					
P. 460	High static pressure ducted	AC	Cooling	4,1 to 21,9 kW	[Blue bar]			[Blue bar]	[Blue bar]
			Heating	4,7 to 21,5 kW	[Orange bar]			[Orange bar]	[Orange bar]
	EC	Cooling	6,6 to 21,4 kW	[Blue bar]			[Blue bar]	[Blue bar]	
		Heating	5,9 to 21,4 kW	[Orange bar]			[Orange bar]	[Orange bar]	
P. 462	4 way cassette	AC	Cooling	1,4 to 8,6 kW	[Blue bar]				
			Heating	1,1 to 12,8 kW	[Orange bar]				
	EC	Cooling	1,4 to 9,4 kW	[Blue bar]					
		Heating	1,1 to 14,0 kW	[Orange bar]					
P. 464	Ceiling chassis	AC	Cooling	0,7 to 8,1 kW	[Blue bar]				
			Heating	0,7 to 10,3 kW	[Orange bar]				
	EC	Cooling	0,5 to 9,6 kW	[Blue bar]					
		Heating	0,6 to 13,6 kW	[Orange bar]					
P. 466	Floor-standing chassis	AC	Cooling	0,7 to 8,1 kW	[Blue bar]				
			Heating	0,7 to 10,3 kW	[Orange bar]				
	EC	Cooling	0,5 to 9,6 kW	[Blue bar]					
		Heating	0,6 to 13,6 kW	[Orange bar]					
P. 468	Wall-mounted	AC	Cooling	1,0 to 3,9 kW	[Blue bar]				
			Heating	1,4 to 4,1 kW	[Orange bar]				
P. 469	Smart fan coils	AC	Cooling	0,2 to 1,7 kW	[Blue bar]				
			Heating	0,2 to 1,7 kW	[Orange bar]				

Values indicated are for the full operating range. The data shown within the tables following are indicative of specific installation conditions. For full details relating to performance and operating conditions, please refer to the technical data manual.



5 kW 6 kW 7 kW 8 kW 9 kW 10 kW 11 kW 12 kW 13 kW 14 kW 15 kW 16 kW 17 kW 18 kW 19 kW 20 kW 21 kW 22 kW

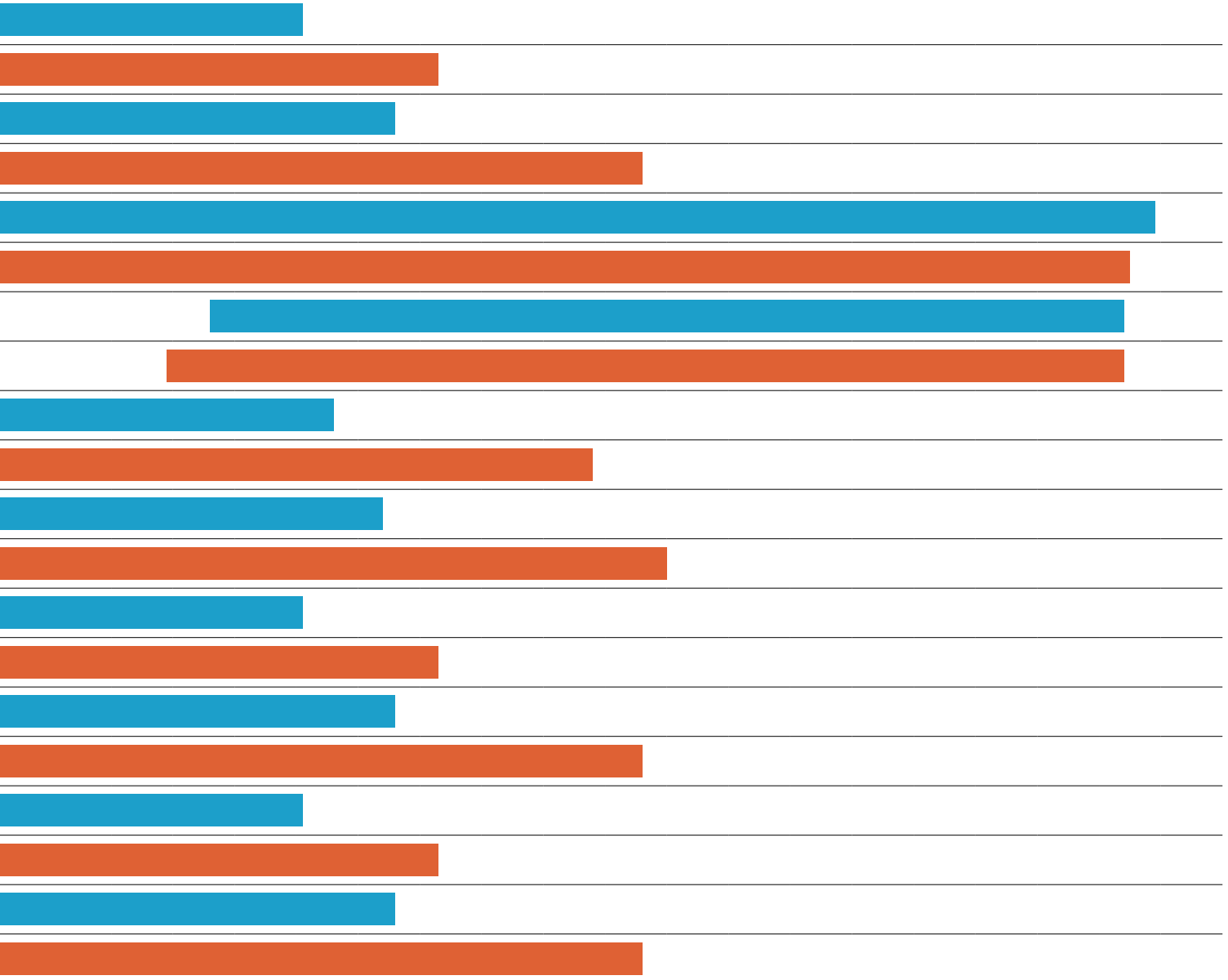

Fan coils - ducted (AC)



Optional controller.
Advanced wired remote controller.
PAW-FC-RC1



Optional controller.
Wired remote controller with touch control.
PAW-FC-907AC



Optional controller.
Wired remote controller.
PAW-FC-903AC



2-pipe - Left connection (PAW-)			FC2A-D010L	FC2A-D020L	FC2A-D030L	FC2A-D040L	FC2A-D050L	FC2A-D060L	FC2A-D070L	FC2A-D080L
2-pipe - Right connection (PAW-)			FC2A-D010R	FC2A-D020R	FC2A-D030R	FC2A-D040R	FC2A-D050R	FC2A-D060R	FC2A-D070R	FC2A-D080R
Total cooling capacity ¹⁾	Lo/Med/Hi	kW	0,7/1,0/1,5	0,7/1,2/1,7	1,0/2,0/2,5	1,2/2,4/3,2	1,7/3,2/4,6	2,7/4,6/5,8	3,4/6,1/7,3	4,6/6,1/8,1
Sensible capacity ¹⁾	Lo/Med/Hi	kW	0,5/0,8/1,1	0,6/0,9/1,3	0,8/1,5/1,9	0,9/1,8/2,3	1,2/2,2/3,3	1,9/3,3/4,5	2,4/4,3/5,1	3,4/4,6/6,3
Water flow	Lo/Med/Hi	l/h	124/172/250	127/213/289	172/341/430	206/413/547	296/544/798	466/784/1003	587/1058/1252	798/1048/1400
Water pressure drop	Lo/Med/Hi	kPa	10,7/19,5/39,2	1,9/3,9/6,3	6,3/19,3/28,8	5,4/17,1/28,0	7,5/22,8/46,9	13,9/37,4/60,2	4,8/15,4/21,5	11,9/19,3/32,5
Heating capacity ²⁾	Lo/Med/Hi	kW	0,9/1,4/2,0	0,9/1,5/2,2	1,3/2,4/3,1	1,4/2,9/4,0	2,1/4,1/5,7	3,1/5,3/7,1	4,3/7,9/9,3	5,9/8,1/11,6
4-pipe - Left connection (PAW-)			FC4A-D010L	FC4A-D020L	FC4A-D030L	FC4A-D040L	FC4A-D050L	FC4A-D060L	FC4A-D070L	FC4A-D080L
4-pipe - Right connection (PAW-)			FC4A-D010R	FC4A-D020R	FC4A-D030R	FC4A-D040R	FC4A-D050R	FC4A-D060R	FC4A-D070R	FC4A-D080R
Total cooling capacity ¹⁾	Lo/Med/Hi	kW	0,7/0,9/1,3	0,6/1,1/1,6	1,0/1,9/2,4	1,1/2,3/3,0	1,7/3,0/4,3	2,6/4,4/5,6	3,3/5,9/6,9	4,5/5,9/8,0
Sensible capacity ¹⁾	Lo/Med/Hi	kW	0,5/0,7/1,0	0,5/0,8/1,2	0,8/1,5/1,8	0,8/1,7/2,2	1,2/2,2/3,1	1,8/3,2/4,3	2,3/4,2/4,9	3,3/4,4/6,2
Water flow	Lo/Med/Hi	l/h	114/159/225	109/192/268	165/327/414	194/388/517	284/522/748	449/756/967	575/1019/1193	775/1020/1380
Water pressure drop	Lo/Med/Hi	kPa	8,3/15,2/29,0	1,5/3,4/5,6	3,0/9,5/14,4	6,4/22,3/36,8	4,2/12,8/25,1	10,2/27,7/44,5	5,9/17,9/24,4	19,3/31,1/53,6
Heating capacity ²⁾	Lo/Med/Hi	kW	0,5/0,7/1,0	0,6/0,9/1,1	1,0/1,4/1,6	0,9/1,6/2,1	1,5/2,3/3,0	1,9/2,9/3,7	2,7/3,6/4,3	3,9/5,6/7,1
Water flow	Lo/Med/Hi	l/h	79/127/178	100/146/190	164/232/274	160/273/354	251/401/508	325/505/633	456/626/736	673/963/1226
Water pressure drop	Lo/Med/Hi	kPa	1,9/3,5/5,6	1,5/3,2/5,3	5,1/9,0/11,9	9,2/26,5/42,7	10,7/24,6/29,5	20,3/43,9/52,9	67,2/117,9/137,8	33,1/63,7/75
Sound levels										
Global sound power	Lo/Med/Hi	dB(A)	33/40/49	31/43/50	30/45/52	30/44/51	34/46/56	38/51/58	43/56/61	50/55/64
Global sound pressure ³⁾	Lo/Med/Hi	dB(A)	24/31/40	22/34/41	21/36/43	21/35/42	25/37/47	29/42/49	34/47/52	41/46/55
Fan										
Number			1	1	1	2	2	2	2	3
Air flow 2-pipe	Lo/Med/Hi	m ³ /h	111/190/283	105/179/265	138/274/390	173/357/499	253/486/716	350/640/933	480/893/1064	660/936/1397
Air flow 4-pipe	Lo/Med/Hi	m ³ /h	95/168/253	89/161/241	132/263/369	162/335/467	242/466/671	334/614/885	470/859/1012	634/905/1370
External pressure	Max	Pa	55	55	65	85	85	115	125	70
Filter			G2	G2	G2	G2	G2	G2	G2	G2
Electrical data										
Power supply	Voltage	V	230	230	230	230	230	230	230	230
	Phase		Single phase	Single phase	Single phase	Single phase	Single phase	Single phase	Single phase	Single phase
	Frequency	Hz	50/60	50/60	50/60	50/60	50/60	50/60	50/60	50/60
Consumption 2-pipe	Lo/Med/Hi	W	13/24/36	10/18/29	16/37/45	15/37/56	28/55/72	37/75/105	53/100/147	90/112/188
Consumption 4-pipe	Lo/Med/Hi	W	13/24/36	10/18/28	16/37/44	15/37/55	28/54/70	37/74/104	53/99/145	90/112/188
Water connections										
Type			Female gas threaded	Female gas threaded	Female gas threaded	Female gas threaded	Female gas threaded	Female gas threaded	Female gas threaded	Female gas threaded
2-pipe		Inch	1/2	1/2	1/2	1/2	1/2	1/2	3/4	3/4
	Cool	Inch	1/2	1/2	1/2	1/2	1/2	1/2	3/4	3/4
4-pipe	Heat	Inch	1/2	1/2	1/2	1/2	1/2	1/2	1/2	1/2
Dimension and weight										
Dimension	HxWxD	mm	220x570x430	220x570x430	220x730x430	220x938x430	220x1122x430	220x1307x430	220x1121x530	220x1316x530
Weight	2 / 4-pipes	kg	13/14	13/14	15/16	20/22	22/24	26/28	27/29	38/40

1) According to Eurovent standard. Air: 27 °C DB / 19 °C WB. Water in / out: 7 °C / 12 °C. 2) Air: 20 °C. Water in / out: 50 °C / 45 °C. 3) The sound pressure levels are based on (NR) characteristics of a room having volume of 100 m³ with reverberation of 0,5 seconds.

Values indicated are for 0 Pa external static pressure, for additional pressure characteristics, please refer the selection software.

Technical focus

- Cooling capacity: 0,7 to 8,1 kW
- Heating capacity: 0,7 to 10,3 kW
- 5-speed AC fan motor(s)

Operating limits

Entering water temperature	From 5 to 90 °C
Indoor air temperature	From 5 to 32 °C

Main features and accessories

- 2 and 4-pipe configurations
- Left or right hand arrangements
- Ease of installation
- Very low acoustic levels
- 2 way or 3 way ON / OFF valves
- Auxiliary drain pan
- Air intake with removable grid
- G2 filter



Fan coils - ducted (EC)



Optional controller.
Wired remote controller
with touch control.
PAW-FC-907EC



Optional controller.
Wired remote controller.
PAW-FC-903EC

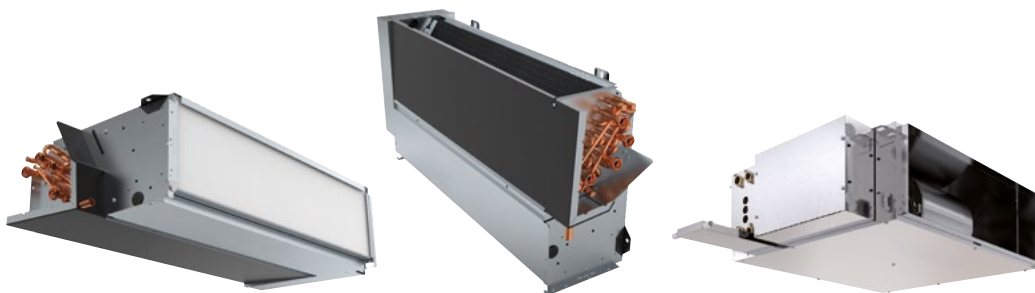

2-pipe - Left connection (PAW-)			FC2E-D010L	FC2E-D020L	FC2E-D030L	FC2E-D040L	FC2E-D050L	FC2E-D060L	FC2E-D070L	FC2E-D080L	FC2E-F040L
2-pipe - Right connection (PAW-)			FC2E-D010R	FC2E-D020R	FC2E-D030R	FC2E-D040R	FC2E-D050R	FC2E-D060R	FC2E-D070R	FC2E-D080R	FC2E-F040R
Total cooling capacity ¹⁾	Lo/Med/Hi	kW	0,6/1,2/2,1	0,6/1,4/2,4	0,9/2,1/3,1	1,3/2,9/4,2	1,3/4,0/5,0	2,0/4,5/5,2	2,7/5,9/6,9	5,1/6,5/8,8	3,6/6,6/9,2
Sensible capacity ¹⁾	Lo/Med/Hi	kW	0,5/1,1/1,9	0,5/1,1/1,9	0,6/1,6/2,4	1,0/2,1/3,0	1,1/3,0/3,7	1,4/3,5/4,0	2,0/4,3/5,2	3,7/4,8/6,6	2,9/6,1/9,1
Water flow	Lo/Med/Hi	l/h	107/210/356	110/237/406	148/354/532	230/506/722	231/685/743	341/767/800	463/1008/1098	879/1111/1254	627/1142/1575
Water pressure drop	Lo/Med/Hi	kPa	8,2/28,2/76,9	1,5/4,6/11,0	5,0/20,5/42,1	6,4/24,4/46,3	4,9/35,1/41,0	7,8/35,8/38,8	3,0/14,0/16,6	14,1/21,4/26,6	10,6/51,2/93,8
Heating capacity ²⁾	Lo/Med/Hi	kW	0,8/1,6/2,9	0,9/1,9/3,3	1,0/2,2/3,4	1,4/3,0/5,3	1,7/5,2/5,5	2,3/5,9/6,1	3,8/7,3/8,2	6,2/8,0/9,3	4,4/8,3/11,8
4-pipe - Left connection (PAW-)			FC4E-D010L	FC4E-D020L	FC4E-D030L	FC4E-D040L	FC4E-D050L	FC4E-D060L	FC4E-D070L	FC4E-D080L	FC4E-F040L
4-pipe - Right connection (PAW-)			FC4E-D010R	FC4E-D020R	FC4E-D030R	FC4E-D040R	FC4E-D050R	FC4E-D060R	FC4E-D070R	FC4E-D080R	FC4E-F040R
Total cooling capacity ¹⁾	Lo/Med/Hi	kW	0,5/1,1/1,9	0,6/1,2/2,2	0,8/1,9/2,9	1,2/2,7/4,0	1,2/3,6/4,6	1,8/4,1/4,9	2,6/5,1/6,4	5,0/6,2/9,6	3,3/6,4/8,8
Sensible capacity ¹⁾	Lo/Med/Hi	kW	0,4/0,9/1,7	0,4/1,0/1,8	0,6/1,5/2,2	0,9/1,9/2,8	1,0/2,8/3,5	1,2/3,2/3,8	1,9/3,8/4,8	3,6/4,6/7,2	2,7/5,6/8,0
Water flow	Lo/Med/Hi	l/h	92/185/327	97/206/375	129/321/493	205/457/681	212/625/686	306/707/749	443/886/977	855/1070/1242	567/1093/1511
Water pressure drop	Lo/Med/Hi	kPa	5,8/20,1/59,2	1,3/3,7/9,7	4,0/9,2/19,7	6,3/29,6/60,1	2,5/17,9/21,3	5,1/24,3/27,2	3,5/13,6/16,5	22,9/33,9/44,3	10,0/47,2/86,7
Heating capacity ²⁾	Lo/Med/Hi	kW	0,4/0,8/1,4	0,6/0,9/1,5	1,0/1,4/1,8	1,2/2,0/2,8	1,6/2,4/2,5	1,4/2,9/3,1	2,5/3,4/3,6	4,5/5,9/6,9	2,5/4,5/6,2
Water flow	Lo/Med/Hi	l/h	76/140/235	95/161/255	166/243/304	204/350/483	267/416/438	233/503/531	434/583/614	767/1011/1194	432/783/1065
Water pressure drop	Lo/Med/Hi	kPa	1,8/4,0/8,4	1,4/3,8/9,4	5,3/9,7/14,1	15,6/41,8/76,3	11,9/26,3/28,9	11,5/43,6/48,1	61,5/103,8/113,9	42,1/69,7/95,1	30,6/107,6/214,8
Sound levels											
Global sound power	Lo/Med/Hi	dB(A)	34/47/60	34/47/60	31/50/59	29/44/52	30/51/57	32/54/58	40/54/59	51/56/64	42/58/68 ³⁾
Global sound pressure ⁴⁾	Lo/Med/Hi	dB(A)	25/38/51	25/38/51	22/41/50	20/35/43	21/42/48	23/45/49	31/45/50	42/47/55	23/39/52
Fan											
Number			1	1	1	2	2	2	2	3	1
Air flow 2-pipe	Lo/Med/Hi	m ³ /h	108/228/417	98/234/413	145/380/585	170/412/678	203/645/816	245/737/912	350/850/1050	685/927/1398	592/1284/1935
Air flow 4-pipe	Lo/Med/Hi	m ³ /h	91/199/379	84/200/380	123/342/540	148/369/627	185/587/646	205/668/716	329/798/894	660/884/1079	523/1222/1864
External pressure	Max	Pa	75	75	75	105	70	105	115	70	190
Filter			G2	G2	G2	G2	G2	G2	G2	G2	G2
Electrical data											
Power supply	Voltage	V	230	230	230	230	230	230	230	230	230
	Phase		Single phase	Single phase	Single phase	Single phase	Single phase	Single phase	Single phase	Single phase	Single phase
	Frequency	Hz	50/60	50/60	50/60	50/60	50/60	50/60	50/60	50/60	50/60
Consumption 2-pipe	Lo/Med/Hi	W	5/11/41	5/13/41	4/16/42	2/13/43	4/24/46	2/30/54	11/44/77	23/42/108	11/62/197
Consumption 4-pipe	Lo/Med/Hi	W	5/11/39	5/13/40	6/15/40	2/12/42	2/23/44	2/28/52	11/43/75	22/41/116	11/60/188
Water connections											
Type			Female gas threaded	Female gas threaded	Female gas threaded	Female gas threaded	Female gas threaded	Female gas threaded	Female gas threaded	Female gas threaded	Female gas threaded
2-pipe		Inch	1/2	1/2	1/2	1/2	1/2	1/2	3/4	3/4	3/4
	Cool	Inch	1/2	1/2	1/2	1/2	1/2	1/2	3/4	3/4	3/4
4-pipe		Inch	1/2	1/2	1/2	1/2	1/2	1/2	1/2	1/2	1/2
	Heat	Inch	1/2	1/2	1/2	1/2	1/2	1/2	1/2	1/2	1/2
Dimension and weight											
Dimension	H x W x D	mm	220x570x430	220x570x430	220x730x430	220x938x430	220x1122x430	220x1307x430	220x1121x530	220x1316x530	223x1233x653
Weight	2 / 4-pipes	kg	13/14	13/14	15/16	20/22	22/24	26/28	27/29	38/40	19/19

1) According to Eurovent standard. Air: 27 °C DB / 19 °C WB. Water in / out: 7 °C / 12 °C. 2) Air: 20 °C. Water in / out: 50 °C / 45 °C. 3) The sound power levels indicated are from return and radiated measurements. 4) The sound pressure levels are based on (NR) characteristics of a room having volume of 100 m³ with reverberation of 0,5 seconds. Values indicated are for 0 Pa external static pressure, for additional pressure characteristics, please refer the selection software.

Technical focus

- Cooling capacity: 0,5 to 9,6 kW
- Heating capacity: 0,6 to 13,6 kW
- Low energy consumption EC fan(s)

Operating limits

Entering water temperature	From 5 to 90 °C
Indoor air temperature	From 5 to 32 °C

Main features and accessories

- 2 and 4-pipe configurations
- Left or right hand arrangements
- Can be installed both horizontally and vertically*
- Ease of installation
- Very low acoustic levels
- 2 way or 3 way ON / OFF valves
- Auxiliary drain pan
- Air intake with removable grid
- G2 filter

* PAW-FC2E-F040 and PAW-FC4E-F040 may only be installed horizontally.



Fan coils - high static pressure ducted (AC)



Optional controller.
Advanced wired remote controller.
PAW-FC-RC1



Optional controller.
Wired remote controller with touch control.
PAW-FC-907AC



Optional controller.
Wired remote controller.
PAW-FC-903AC

2-pipe - Left connection			PAW-FC2A-E070L	PAW-FC2A-E150L	PAW-FC2A-E180L	PAW-FC2A-E210L	PAW-FC2A-E240L*	PAW-FC2A-E270L*
2-pipe - Right connection			PAW-FC2A-E070R	PAW-FC2A-E150R	PAW-FC2A-E180R	PAW-FC2A-E210R	PAW-FC2A-E240R*	PAW-FC2A-E270R*
Total cooling capacity ¹⁾	Lo/Med/Hi	kW	4,4/5,5/6,4	5,6/11,5/14,2	4,9/11,5/15,0	5,2/13,7/18,6	14,3/19,8/23,3	15,8/23,0/27,5
Sensible capacity ¹⁾	Lo/Med/Hi	kW	3,12/5,1	3,9/9,2/12,2	3,7/9,5/13,1	3,5/9,9/13,7	10,3/14,9/17,8	11,0/16,3/19,7
Water flow	Lo/Med/Hi	l/h	749/951/1095	966/1979/2437	837/1979/2589	899/2357/3201	2468/3410/4015	2718/3951/4740
Water pressure drop	Lo/Med/Hi	kPa	26,5/42,5/56,2	5,5/19,9/29,3	4,4/19,6/32,0	4,9/28,8/51,5	13,8/25,2/34,2	12,8/25,2/35,3
Heating capacity ²⁾	Lo/Med/Hi	kW	5,4/8,6/12,7	6,2/14,2/20,0	6,3/16,3/23,2	6,1/16,5/23,4	17,2/26,3/32,6	17,9/27,5/33,7
4-pipe - Left connection			PAW-FC4A-E070L	PAW-FC4A-E150L	PAW-FC4A-E180L	PAW-FC4A-E210L	PAW-FC4A-E240L*	PAW-FC4A-E270L*
4-pipe - Right connection			PAW-FC4A-E070R	PAW-FC4A-E150R	PAW-FC4A-E180R	PAW-FC4A-E210R	PAW-FC4A-E240R*	PAW-FC4A-E270R*
Total cooling capacity ¹⁾	Lo/Med/Hi	kW	4,0/5,4/6,0	5,3/10,1/11,9	5,5/11,2/13,6	5,9/14,4/18,8	13,3/17,7/20,5	14,3/19,9/23,4
Sensible capacity ¹⁾	Lo/Med/Hi	kW	2,8/4,1/4,7	3,7/8,4/10,9	3,9/9,1/12,0	4,0/10,6/14,5	9,9/13,9/16,3	10,3/14,9/17,8
Water flow	Lo/Med/Hi	l/h	680/924/1035	919/1739/2044	951/1928/2335	1013/2478/3241	2291/3053/3526	2464/3427/4032
Water pressure drop	Lo/Med/Hi	kPa	29,7/52,1/64,4	4,1/13,5/18,4	4,7/17,4/25,0	6,6/35,2/59,1	14,5/25,0/33,0	12,8/23,3/31,5
Heating capacity ²⁾	Lo/Med/Hi	kW	3,7/6,0/7,4	5,3/11,8/15,9	5,3/11,9/15,9	5,3/11,9/16,0	7,2/11,1/13,5	7,2/11,1/13,5
Water flow	Lo/Med/Hi	l/h	636/1029/1266	906/2038/2746	911/2045/2745	916/2051/2747	1242/1910/2329	1242/1910/2329
Water pressure drop	Lo/Med/Hi	kPa	14,2/30,7/43,6	39,0/167,6/293,0	23,9/100,8/174,3	24,2/101,4/174,6	45,8/87,8/120,3	28,3/53,3/72,5
Sound levels								
Sound power return + radiated	Lo/Med/Hi	dB(A)	54/60/63	52/66/72	54/66/74	52/66/72	65/73/75	65/73/75
Sound power discharge	Lo/Med/Hi	dB(A)	53/59/62	52/64/71	52/64/71	52/64/71	64/72/75	64/72/75
Sound pressure ³⁾	Lo/Med/Hi	dB(A)	33/39/42	31/45/51	31/45/51	31/45/51	44/52/54	44/52/54
Fan								
Number			1	1	1	1	1	1
Air flow 2-pipe	Lo/Med/Hi	m ³ /h	680/1091/1562	676/2110/3197	676/2110/3197	676/2110/3197	1927/3130/3923	1927/3130/3923
Air flow 4-pipe	Lo/Med/Hi	m ³ /h	552/1132/1496	676/2110/3197	676/2110/3197	676/2110/3197	1927/3130/3923	1927/3130/3923
External pressure	Max	Pa	110	200	200	200	220	220
Filter			G3	G3	G3	G3	G3	G3
Electrical data								
Power supply	Voltage	V	230	230	230	230	230	230
	Phase		Single phase	Single phase	Single phase	Single phase	Single phase	Single phase
	Frequency	Hz	50/60	50/60	50/60	50/60	50/60	50/60
Consumption	Lo/Med/Hi	W	132/182/222	180/421/675	180/421/675	180/421/675	420/530/673	420/530/673
Water connections								
Type			Female gas threaded	Gas Male threaded	Gas Male threaded	Gas Male threaded	Gas Male threaded	Gas Male threaded
2-pipe	Cool	Inch	1/2	1	1 1/4	1 1/4	1 1/4	1 1/4
	Heat	Inch	1/2	3/4	3/4	3/4	3/4	3/4
4-pipe	Cool	Inch	1/2	1	1	1	1 1/4	1 1/4
	Heat	Inch	1/2	3/4	3/4	3/4	3/4	3/4
Dimension and weight								
Dimension	H x W x D	mm	250 x 1200 x 698	375 x 1380 x 798	375 x 1380 x 798	375 x 1380 x 798	450 x 1500 x 798	450 x 1500 x 798
Weight		kg	42	63	65	67	76	80

1) According to Eurovent standard. Air: 27 °C DB / 19 °C WB. Water in / out: 7 °C / 12 °C. 2) Air: 20 °C. Water in / out: 50 °C / 45 °C. 3) Informative data: Considering an hypothetical sound attenuation of the room and installation of 21 dB.

Values indicated are for 50 Pa external static pressure, for additional pressure characteristics, please refer the selection software.

* High fan speed used for capacity, water flow, sound and air flow values.

Technical focus

- 6 sizes
- Cooling capacity: 4,1 to 21,9 kW
- Heating capacity: 4,7 to 21,5 kW
- 5-speed AC fan motor

Main features and accessories

- 2 and 4-pipe, left and right hand configurations
- Static pressure up to 220Pa
- Double skin insulation
- 2 way or 3 way ON / OFF valves
- Auxiliary drain pan
- Air intake with removable grid
- G3 filter

Operating limits	
Entering water temperature	From 5 to 90 °C
Indoor air temperature	From 5 to 32 °C



Fan coils - high static pressure ducted (EC)



Optional controller.
Wired remote controller
with touch control.
PAW-FC-907EC



Optional controller.
Wired remote controller.
PAW-FC-903EC

2-pipe - Left connection			PAW-FC2E-E070L	PAW-FC2E-E150L	PAW-FC2E-E180L	PAW-FC2E-E210L	PAW-FC2E-E240L	PAW-FC2E-E270L
2-pipe - Right connection			PAW-FC2E-E070R	PAW-FC2E-E150R	PAW-FC2E-E180R	PAW-FC2E-E210R	PAW-FC2E-E240R	PAW-FC2E-E270R
Total cooling capacity ¹⁾	Lo/Med/Hi	kW	- /4,9/6,5	7,0/11,3/14,5	7,8/13,1/17,3	8,6/14,2/19,0	9,3/16,1/20,3	10,2/18,1/23,1
Sensible capacity ¹⁾	Lo/Med/Hi	kW	- /3,6/5,2	5,2/9,1/12,1	5,7/10,3/14,1	6,1/10,9/15,0	6,7/12,4/16,2	7,2/13,6/17,8
Water flow	Lo/Med/Hi	l/h	- /844/1127	1207/1945/2498	1351/2259/2979	1476/2451/3275	1592/2766/3498	1751/3120/3972
Water pressure drop	Lo/Med/Hi	kPa	- /33,5 /59,4	11,5/19,3/30,7	6,1/24,9/41,5	6,0/31,0/53,8	6,3/17,1/26,4	5,9/16,4/25,4
Heating capacity ²⁾	Lo/Med/Hi	kW	- /7,0/15,5	88/15,8/20,7	9,5/17,9/24,3	10,0/19,4/26,8	11,1/20,8/27,5	11,7/22,8/30,4
4-pipe - Left connection			PAW-FC4E-E070L	PAW-FC4E-E150L	PAW-FC4E-E180L	PAW-FC4E-E210L	PAW-FC4E-E240L	PAW-FC4E-E270L
4-pipe - Right connection			PAW-FC4E-E070R	PAW-FC4E-E150R	PAW-FC4E-E180R	PAW-FC4E-E210R	PAW-FC4E-E240R	PAW-FC4E-E270R
Total cooling capacity ¹⁾	Lo/Med/Hi	kW	- /4,7/6,2	5,9/9,1/11,6	6,6/10,2/13,0	7,9/12,6/16,4	8,4/14,0/17,5	8,9/15,3/19,5
Sensible capacity ¹⁾	Lo/Med/Hi	kW	- /3,5/4,9	4,5/7,6/10,1	4,9/8,4/11,2	5,8/9,9/13,4	6,2/11,0/14,2	6,5/11,8/15,5
Water flow	Lo/Med/Hi	l/h	- /816/1066	1011/1567/2005	1141/1764/2243	1361/2175/2826	1447/2409/3020	1529/2641/3359
Water pressure drop	Lo/Med/Hi	kPa	- /41,4/68,0	4,9/11,1/17,7	6,5/14,7/23,2	7,6/27,5/45,4	6,2/15,9/24,5	5,5/14,5/22,4
Heating capacity ²⁾	Lo/Med/Hi	kW	- /4,7/7,7	3,6/5,8/7,3	6,1/10,0/12,8	6,1/10,1/12,9	4,8/8,3/10,3	4,7/8,2/10,5
Water flow	Lo/Med/Hi	l/h	- /813/1333	621/991/1264	1052/1729/2211	1057/1734/2227	832/1421/1780	804/1407/1804
Water pressure drop	Lo/Med/Hi	kPa	- /20,9/47,6	20,7/45,6/70,1	30,7/74,1/116,4	30,8/74,5/118,0	19,6/55,9/78,7	7,2/33,9/48,9
Sound levels								
Sound power return + radiated	Lo/Med/Hi	dB(A)	- /60/63	56/67/74	56/67/74	56/67/74	58/69/76	58/69/76
Sound power discharge	Lo/Med/Hi	dB(A)	- /59/62	56/65/74	56/65/74	56/65/74	58/67/76	58/67/76
Sound pressure ³⁾	Lo/Med/Hi	dB(A)	- /39/42	35/46/52	35/46/52	35/46/52	37/48/54	37/48/54
Fan								
Number			1	1	1	1	1	1
Air flow 2-pipe	Lo/Med/Hi	m ³ /h	- /849/1665	1071/2418/3583	1071/2418/3583	1071/2418/3583	1227/2700/3829	1227/2700/3829
Air flow 4-pipe	Lo/Med/Hi	m ³ /h	- /803/1600	1071/2418/3583	1071/2418/3583	1071/2418/3583	1227/2700/3829	1227/2700/3829
External pressure	Max	Pa	50	300	300	300	300	300
Filter			G3	G3	G3	G3	G3	G3
Electrical data								
Power supply	Voltage	V	230	230	230	230	230	230
	Phase		Single phase	Single phase	Single phase	Single phase	Single phase	Single phase
	Frequency	Hz	50/60	50/60	50/60	50/60	50/60	50/60
Consumption	Lo/Med/Hi	W	- /60/235	67/172/246	67/172/246	67/172/246	64/237/364	64/237/364
Water connections								
Type			Female gas threaded	Gas Male threaded	Gas Male threaded	Gas Male threaded	Gas Male threaded	Gas Male threaded
2-pipe	Inch		1/2	1	1 1/4	1 1/4	1 1/4	1 1/4
	Cool	Inch	1/2	1	1	1	1 1/4	1 1/4
4-pipe	Heat	Inch	1/2	3/4	3/4	3/4	3/4	3/4
Dimension and weight								
Dimension	HxWxD	mm	250x1200x698	375x1380x798	375x1380x798	375x1380x798	450x1500x798	450x1500x798
Weight		kg	42	63	65	67	76	80

1) According to Eurovent standard. Air: 27 °C DB / 19 °C WB. Water in / out: 7 °C / 12 °C. 2) Air: 20 °C. Water in / out: 50 °C / 45 °C. 3) Informative data: Considering an hypothetical sound attenuation of the room and installation of 21 dB.

Values indicated are for 50 Pa external static pressure, for additional pressure characteristics, please refer the selection software.

Technical focus

- 6 sizes
- Cooling capacity: 6,6 to 19,9 kW
- Heating capacity: 5,9 to 21,4 kW
- Low energy consumption EC fan

Main features and accessories

- 2 and 4-pipe, left and right hand configurations
- Static pressure up to 300Pa
- Double skin insulation
- 2 way or 3 way ON / OFF valves
- Auxiliary drain pan
- Air intake with removable grid
- G3 filter

Operating limits

Entering water temperature	From 5 to 90 °C
Indoor air temperature	From 5 to 32 °C



Fan coils - 4 way cassette (AC)



Optional controller.
Advanced wired remote controller.
PAW-FC-RC1



Optional controller.
Wired remote controller with touch control.
PAW-FC-907AC



Optional controller.
Wired remote controller.
PAW-FC-903AC

2-pipe			PAW-FC2A-U020-2	PAW-FC2A-U030-2	PAW-FC2A-U040-2	PAW-FC2A-U050-2	PAW-FC2A-U060-2	PAW-FC2A-U070-2
Total cooling capacity ¹⁾	Lo/Med/Hi	kW	1,5/1,8/2,4	1,9/2,7/4,0	2,8/3,5/4,7	3,4/4,4/6,1	3,7/5,4/7,2	4,0/6,5/8,6
Sensible capacity ¹⁾	Lo/Med/Hi	kW	1,3/1,5/2,0	1,4/2,2/3,0	2,1/2,6/3,6	2,6/3,4/4,8	2,7/4,0/5,4	3,0/4,8/6,4
Water flow	Lo/Med/Hi	l/h	265/303/404	323/493/683	478/597/801	576/762/142	636/937/1233	695/1111/1476
Water pressure drop	Lo/Med/Hi	kPa	4,3/6,8/10,9	3,6/8,5/14,4	6,9/11,2/18,3	8,4/13,0/21,9	3,4/7,5/11,5	5,6/13,0/20,5
Heating capacity ²⁾	Lo/Med/Hi	kW	2,2/2,5/3,2	2,3/3,7/4,5	3,7/4,6/6,2	4,5/6,0/8,1	4,5/7,4/10,0	5,2/9,2/12,0
4-pipe			PAW-FC4A-U020-2	PAW-FC4A-U030-2	PAW-FC4A-U040-2	—	PAW-FC4A-U060-2	PAW-FC4A-U070-2
Total cooling capacity ¹⁾	Lo/Med/Hi	kW	1,4/1,5/2,0	2,0/2,7/3,4	2,5/3,3/4,0	—	3,0/4,9/6,6	3,2/6,0/7,5
Sensible capacity ¹⁾	Lo/Med/Hi	kW	1,2/1,4/1,8	1,5/2,1/2,6	2,0/2,6/3,2	—	2,3/3,8/5,1	2,5/4,6/5,9
Water flow	Lo/Med/Hi	l/h	232/258/359	342/465/576	437/563/683	—	511/851/1137	543/1030/1294
Water pressure drop	Lo/Med/Hi	kPa	6,6/8,9/13,6	4,4/8,3/11,6	6,7/11,2/15,3	—	6,0/13,9/22,2	7,1/18,9/27,5
Heating capacity ²⁾	Lo/Med/Hi	kW	0,8/0,9/1,2	2,2/3,1/3,8	3,0/3,5/4,1	—	3,7/5,5/7,0	4,5/7,1/8,9
Water flow	Lo/Med/Hi	l/h	132/153/201	374/530/658	521/603/699	—	636/939/1210	776/1214/1540
Water pressure drop	Lo/Med/Hi	kPa	25,7/33,4/53,6	13,7/24,2/35	24,2/30,9/39,8	—	7,6/13,8/20,7	10,2/20,8/30,9
Sound levels								
Global sound power 2-pipe	Lo/Med/Hi	dB(A)	36/40/49	35/47/53	42/48/57	35/40/49	38/46/54	40/52/59
Global sound power 4-pipe	Lo/Med/Hi	dB(A)	36/40/49	35/47/53	42/48/57	—	38/46/54	40/52/59
Global sound pressure 2-pipe ³⁾	Lo/Med/Hi	dB(A)	27/31/40	26/35/44	33/39/48	26/31/40	29/37/45	31/43/50
Global sound pressure 4-pipe ³⁾	Lo/Med/Hi	dB(A)	27/31/40	26/35/44	33/39/48	—	29/37/45	31/43/50
Fan								
Number			1	1	1	1	1	1
Air flow	Lo/Med/Hi	m ³ /h	360/450/659	320/504/734	486/626/900	529/720/979	500/824/1159	601/1080/1447
Filter			G1	G1	G1	G1	G1	G1
Electrical data								
Power supply	Voltage	V	230	230	230	230	230	230
	Phase		Single phase	Single phase	Single phase	Single phase	Single phase	Single phase
	Frequency	Hz	50	50	50	50	50	50
Consumption 2-pipe	Lo/Med/Hi	W	25/35/58	17/34/58	38/58/99	28/41/66	34/61/88	44/92/125
Consumption 4-pipe	Lo/Med/Hi	W	25/35/58	17/34/58	38/58/99	—	34/61/88	44/92/125
Water connections								
Type			Female gas threaded	Female gas threaded	Female gas threaded	Female gas threaded	Female gas threaded	Female gas threaded
2-pipe		Inch	3/4	3/4	3/4	1	1	1
	Cool	Inch	3/4	3/4	3/4	—	1	1
4-pipe	Heat	Inch	1/2	1/2	1/2	—	3/4	3/4
Dimension and weight								
Dimension including panel	H x W x D	mm	334 x 720 x 720	334 x 720 x 720	334 x 720 x 720	339 x 960 x 960	339 x 960 x 960	339 x 960 x 960
Weight		kg	14,8	16,5	16,5	37,1	37,1	39,6
Panel reference			PAW-FC-KPY2040	PAW-FC-KPY2040	PAW-FC-KPY2040	PAW-FC-KPU5070	PAW-FC-KPU5070	PAW-FC-KPU5070

1) According to Eurovent standard. Air: 27 °C DB / 19 °C WB. Water in / out: 7 °C / 12 °C. 2) According to Eurovent standard. Air: 20 °C. Water in / out: 45 °C / 40 °C. 3) Information data considering an hypothetical sound attenuation of the room and installation of -9 dB(A).

Technical focus

- 6 sizes*
- Cooling capacity: 1,4 to 8,6 kW
- Heating capacity: 1,1 to 12,8 kW
- 3-speed AC fan motor

Main features and accessories

- 2 and 4-pipe configurations
- Very low acoustic levels
- Quick access, by simply removing the front grille
- All connections: located at the same side
- Galvanized steel sheet with thermal and acoustical insulation, avoiding condensation on the casing and providing good sound attenuation
- Cleanable synthetic-type air filter

Operating limits	
Entering water temperature	From 5 to 90 °C
Indoor air temperature	From 5 to 32 °C

* 5 sizes available for 4-pipe configuration.



Fan coils - 4 way cassette (EC)



Optional controller.
Wired remote controller
with touch control.
PAW-FC-907EC



Optional controller.
Wired remote controller.
PAW-FC-903EC



2-pipe			PAW-FC2E-U020-2	PAW-FC2E-U030-2	PAW-FC2E-U040-2	PAW-FC2E-U050-2	PAW-FC2E-U060-2	PAW-FC2E-U070-2
Total cooling capacity ¹⁾	Lo/Med/Hi	kW	1,6/1,8/2,4	1,9/2,9/4,0	2,8/3,5/4,7	3,4/4,4/6,1	3,7/5,5/7,2	4,1/6,5/9,6
Sensible capacity ¹⁾	Lo/Med/Hi	kW	1,3/1,5/2,0	1,4/2,2/3,1	2,1/2,7/3,6	2,6/3,5/4,7	2,7/4,1/5,4	3,0/4,9/7,2
Water flow	Lo/Med/Hi	l/h	267/306/409	325/497/688	481/604/808	579/765/1050	640/944/1243	700/1119/1649
Water pressure drop	Lo/Med/Hi	kPa	4,2/6,9/11,2	3,5/8,6/14,6	6,8/11,4/18,6	8,4/13,1/22,2	3,4/7,6/11,7	5,8/13,1/24,6
Heating capacity ²⁾	Lo/Med/Hi	kW	2,2/2,5/3,2	2,3/3,7/4,5	3,7/4,6/6,2	4,5/6,0/8,1	4,5/7,4/10,0	5,2/9,2/13,0
4-pipe			PAW-FC4E-U020-2	PAW-FC4E-U030-2	PAW-FC4E-U040-2	—	PAW-FC4E-U060-2	PAW-FC4E-U070-2
Total cooling capacity ¹⁾	Lo/Med/Hi	kW	1,4/1,5/2,0	2,0/2,7/3,4	2,6/3,2/4,0	—	3,0/5,0/6,6	3,2/6,1/7,9
Sensible capacity ¹⁾	Lo/Med/Hi	kW	1,2/1,4/1,9	1,5/2,1/2,6	2,1/2,6/3,3	—	2,3/3,8/5,1	2,6/4,7/6,3
Water flow	Lo/Med/Hi	l/h	234/262/344	344/464/581	442/556/690	—	516/858/1144	549/1041/1366
Water pressure drop	Lo/Med/Hi	kPa	6,6/9,1/14,0	4,4/8,2/11,7	6,7/10,9/15,5	—	6,0/14,1/22,4	7,2/19,2/30,1
Heating capacity ²⁾	Lo/Med/Hi	kW	0,8/0,9/1,2	2,2/3,1/3,8	3,0/3,5/4,1	—	3,7/5,5/7,0	4,5/7,1/9,8
Water flow	Lo/Med/Hi	l/h	132/153/201	374/530/658	521/603/699	—	636/939/1210	776/1214/1686
Water pressure drop	Lo/Med/Hi	kPa	25,7/33,4/53,6	13,7/24,2/35	24,2/30,9/39,8	—	7,6/13,8/20,7	10,2/20,8/36
Sound levels								
Global sound power 2-pipe	Lo/Med/Hi	dB(A)	36/40/49	35/47/53	42/48/57	35/40/49	38/46/54	40/52/59
Global sound power 4-pipe	Lo/Med/Hi	dB(A)	36/40/49	35/44/53	42/48/57	—	38/46/54	40/52/59
Global sound pressure 2-pipe ³⁾	Lo/Med/Hi	dB(A)	27/31/40	26/35/44	33/39/48	26/31/40	29/37/45	31/43/50
Global sound pressure 4-pipe ³⁾	Lo/Med/Hi	dB(A)	27/31/40	26/35/44	33/39/48	—	29/37/45	31/43/50
Fan								
Number			1	1	1	1	1	1
Air flow	Lo/Med/Hi	m ³ /h	360/450/659	320/504/734	486/626/900	529/720/979	500/824/1159	601/1080/1598
Filter			G1	G1	G1	G1	G1	G1
Electrical data								
Power supply	Voltage	V	230	230	230	230	230	230
	Phase		Single phase	Single phase	Single phase	Single phase	Single phase	Single phase
	Frequency	Hz	50	50	50	50	50	50
Consumption 2-pipe	Lo/Med/Hi	W	9/13/29	7/14/32	13/22/57	7/12/25	9/23/25	11/40/115
Consumption 4-pipe	Lo/Med/Hi	W	9/13/29	7/14/32	13/22/57	—	9/23/46	11/40/115
Water connections								
Type			Female gas threaded	Female gas threaded	Female gas threaded	Female gas threaded	Female gas threaded	Female gas threaded
2-pipe	Inch		3/4	3/4	3/4	1	1	1
4-pipe	Cool	Inch	3/4	3/4	3/4	—	1	1
	Heat	Inch	1/2	1/2	1/2	—	3/4	3/4
Dimension and weight								
Dimension including panel	H x W x D	mm	334 x 720 x 720	334 x 720 x 720	334 x 720 x 720	339 x 960 x 960	339 x 960 x 960	339 x 960 x 960
Weight		kg	14,8	16,5	16,5	37,1	37,1	39,6
Panel reference			PAW-FC-KPY2040	PAW-FC-KPY2040	PAW-FC-KPY2040	PAW-FC-KPU5070	PAW-FC-KPU5070	PAW-FC-KPU5070

1) According to Eurovent standard. Air: 27 °C DB / 19 °C WB. Water in / out: 7 °C / 12 °C. 2) According to Eurovent standard. Air: 20 °C. Water in / out: 45 °C / 40 °C. 3) Information data considering an hypothetical sound attenuation of the room and installation of -9 dB(A).

Technical focus

- 6 sizes*
- Cooling capacity: 1,4 to 9,4 kW
- Heating capacity: 1,1 to 14,0 kW
- Low energy consumption EC fan

Main features and accessories

- 2 and 4-pipe configurations
- Very low acoustic levels
- Quick access, by simply removing the front grille
- All connections: located at the same side
- Galvanized steel sheet with thermal and acoustical insulation, avoiding condensation on the casing and providing good sound attenuation
- Cleanable synthetic-type air filter

Operating limits

Entering water temperature	From 5 to 90 °C
Indoor air temperature	From 5 to 32 °C

* 5 sizes available for 4-pipe configuration.



Fan coils - ceiling chassis (AC)



Optional controller.
Advanced wired remote controller.
PAW-FC-RC1



Optional controller.
Wired remote controller with touch control.
PAW-FC-907AC



Optional controller.
Wired remote controller.
PAW-FC-903AC

2-pipe - Left connection (PAW-)		FC2A-T010L	FC2A-T020L	FC2A-T030L	FC2A-T040L	FC2A-T050L	FC2A-T060L	FC2A-T070L	FC2A-T080L	
2-pipe - Right connection (PAW-)		FC2A-T010R	FC2A-T020R	FC2A-T030R	FC2A-T040R	FC2A-T050R	FC2A-T060R	FC2A-T070R	FC2A-T080R	
Total cooling capacity ¹⁾	Lo/Med/Hi kW	0,7/1,0/1,5	0,7/1,2/1,7	1,0/2,0/2,5	1,2/2,4/3,2	1,7/3,2/4,6	2,7/4,6/5,8	3,4/6,1/7,3	4,6/6,1/8,1	
Sensible capacity ¹⁾	Lo/Med/Hi kW	0,5/0,8/1,1	0,6/0,9/1,3	0,8/1,5/1,9	0,9/1,8/2,3	1,2/2,2/3,3	1,9/3,3/4,5	2,4/4,3/5,1	3,4/4,6/6,3	
Water flow	Lo/Med/Hi l/h	124/172/250	127/213/289	172/341/430	206/413/547	296/544/798	466/784/1003	587/1058/1252	798/1048/1400	
Water pressure drop	Lo/Med/Hi kPa	10,7/19,5/39,2	1,9/3,9/6,3	6,3/19,3/28,8	5,4/17,1/28,0	7,5/22,8/46,9	13,9/37,4/60,2	4,8/15,4/21,5	11,9/19,3/32,5	
Heating capacity ²⁾	Lo/Med/Hi kW	0,9/1,4/2,0	0,9/1,5/2,2	1,3/2,4/3,1	1,4/2,9/4,0	2,1/4,1/5,7	3,1/5,3/7,1	4,3/7,9/9,3	5,9/8,1/11,6	
4-pipe - Left connection (PAW-)		FC4A-T010L	FC4A-T020L	FC4A-T030L	FC4A-T040L	FC4A-T050L	FC4A-T060L	FC4A-T070L	FC4A-T080L	
4-pipe - Right connection (PAW-)		FC4A-T010R	FC4A-T020R	FC4A-T030R	FC4A-T040R	FC4A-T050R	FC4A-T060R	FC4A-T070R	FC4A-T080R	
Total cooling capacity ¹⁾	Lo/Med/Hi kW	0,7/0,9/1,3	0,6/1,1/1,6	1,0/1,9/2,4	1,1/2,3/3,0	1,7/3,0/4,3	2,6/4,4/5,6	3,3/5,9/6,9	4,5/5,9/8,0	
Sensible capacity ¹⁾	Lo/Med/Hi kW	0,5/0,7/1,0	0,5/0,8/1,2	0,8/1,5/1,8	0,8/1,7/2,2	1,2/2,2/3,1	1,8/3,2/4,3	2,3/4,2/4,9	3,3/4,4/6,2	
Water flow	Lo/Med/Hi l/h	114/159/225	109/192/268	165/327/414	194/388/517	284/522/748	449/756/967	575/1019/1193	775/1020/1380	
Water pressure drop	Lo/Med/Hi kPa	8,3/15,2/29,0	1,5/3,4/5,6	3,0/9,5/14,4	6,4/22,3/36,8	4,2/12,8/25,1	10,2/27,7/44,5	5,9/17,9/24,4	19,3/31,1/53,6	
Heating capacity ²⁾	Lo/Med/Hi kW	0,5/0,7/1,0	0,6/0,9/1,1	1,0/1,4/1,6	0,9/1,6/2,1	1,5/2,3/3,0	1,9/2,9/3,7	2,7/3,6/4,3	3,9/5,6/7,1	
Water flow	Lo/Med/Hi l/h	79/127/178	100/146/190	164/232/274	160/273/354	251/401/508	325/505/633	456/626/736	673/963/1226	
Water pressure drop	Lo/Med/Hi kPa	1,9/3,5/5,6	1,5/3,2/5,3	5,1/9,0/11,9	9,2/26,5/42,7	10,7/24,6/29,5	20,3/43,9/52,9	67,2/117,9/137,8	33,1/63,7/75	
Sound levels										
Global sound power	Lo/Med/Hi dB(A)	33/40/49	31/43/50	30/45/52	30/44/51	34/46/56	38/51/58	43/56/61	50/55/64	
Global sound pressure ³⁾	Lo/Med/Hi dB(A)	24/31/40	22/34/41	21/36/43	21/35/42	25/37/47	29/42/49	34/47/52	41/46/55	
Fan										
Number		1	1	1	2	2	2	2	3	
Air flow 2-pipe	Lo/Med/Hi m ³ /h	111/190/283	105/179/265	138/274/390	173/357/499	253/486/716	350/640/933	480/893/1064	660/936/1397	
Air flow 4-pipe	Lo/Med/Hi m ³ /h	95/168/253	89/161/241	132/263/369	162/335/467	242/466/671	334/614/885	470/859/1012	634/905/1370	
Filter		G2	G2	G2	G2	G2	G2	G2	G2	
Electrical data										
Power supply	Voltage	V	230	230	230	230	230	230	230	
	Phase		Single phase	Single phase	Single phase	Single phase	Single phase	Single phase	Single phase	
	Frequency	Hz	50/60	50/60	50/60	50/60	50/60	50/60	50/60	
Consumption 2-pipe	Lo/Med/Hi W	13/24/36	10/18/29	16/37/45	15/37/56	28/55/72	37/75/105	53/100/147	90/112/188	
Consumption 4-pipe	Lo/Med/Hi W	13/24/36	10/18/28	16/37/44	15/37/55	28/54/70	37/74/104	53/99/145	90/112/188	
Water connections										
Type		Female gas threaded	Female gas threaded	Female gas threaded	Female gas threaded	Female gas threaded	Female gas threaded	Female gas threaded	Female gas threaded	
2-pipe	Cool	Inch	1/2	1/2	1/2	1/2	1/2	3/4	3/4	
	Heat	Inch	1/2	1/2	1/2	1/2	1/2	1/2	1/2	
4-pipe	Cool	Inch	1/2	1/2	1/2	1/2	1/2	3/4	3/4	
	Heat	Inch	1/2	1/2	1/2	1/2	1/2	1/2	1/2	
Dimension and weight										
Dimension	H x W x D	mm	225 x 766 x 477	225 x 766 x 477	225 x 951 x 477	225 x 1136 x 477	225 x 1321 x 477	225 x 1506 x 477	225 x 1319 x 477	225 x 1506 x 477
Weight	2 / 4-pipes	kg	19/20	19/20	22/23	27/29	30/32	35/37	35/37	47/49

1) According to Eurovent standard. Air: 27 °C DB / 19 °C WB. Water in / out: 7 °C / 12 °C. 2) Air: 20 °C. Water in / out: 50 °C / 45 °C. 3) The sound pressure levels are based on (NR) characteristics of a room having volume of 100 m³ with reverberation of 0,5 seconds.

Technical focus

- Cooling capacity: 0,7 to 8,1 kW
- Heating capacity: 0,7 to 10,3 kW
- 5-speed AC fan motor(s)

Main features and accessories

- 2 and 4-pipe configurations
- Left or right hand arrangements
- Ease of installation
- Very low acoustic levels
- 2 way or 3 way ON / OFF valves
- Auxiliary drain pan
- Air intake with removable grid
- G2 filter

Operating limits

Entering water temperature	From 5 to 90 °C
Indoor air temperature	From 5 to 32 °C



Fan coils - ceiling chassis (EC)



Optional controller.
Wired remote controller
with touch control.
PAW-FC-907EC



Optional controller.
Wired remote controller.
PAW-FC-903EC

2-pipe - Left connection (PAW-)			FC2E-T010L	FC2E-T020L	FC2E-T030L	FC2E-T040L	FC2E-T050L	FC2E-T060L	FC2E-T070L	FC2E-T080L
2-pipe - Right connection (PAW-)			FC2E-T010R	FC2E-T020R	FC2E-T030R	FC2E-T040R	FC2E-T050R	FC2E-T060R	FC2E-T070R	FC2E-T080R
Total cooling capacity ¹⁾	Lo/Med/Hi	kW	0,6/1,2/2,1	0,6/1,4/2,4	0,9/2,1/3,1	1,3/2,9/4,2	1,3/4,0/5,0	2,0/4,5/5,2	2,7/5,9/6,9	5,1/6,5/8,8
Sensible capacity ¹⁾	Lo/Med/Hi	kW	0,5/1,1/1,9	0,5/1,1/1,9	0,6/1,6/2,4	1,0/2,1/3,0	1,1/3,0/3,7	1,4/3,5/4,0	2,0/4,3/5,2	3,7/4,8/6,6
Water flow	Lo/Med/Hi	l/h	107/210/356	110/237/406	148/354/532	230/506/722	231/685/743	341/767/800	463/1008/1098	879/1111/1254
Water pressure drop	Lo/Med/Hi	kPa	8,2/28,2/76,9	1,5/4,6/11,0	5,0/20,5/42,1	6,4/24,4/46,3	4,9/35,1/41,0	7,8/35,8/38,8	3,0/14,0/16,6	14,1/21,4/26,6
Heating capacity ²⁾	Lo/Med/Hi	kW	0,8/1,6/2,9	0,9/1,9/3,3	1,0/2,2/3,4	1,4/3,0/5,3	1,7/5,2/5,5	2,3/5,9/6,1	3,8/7,3/8,2	6,2/8,0/9,3
4-pipe - Left connection (PAW-)			FC4E-T010L	FC4E-T020L	FC4E-T030L	FC4E-T040L	FC4E-T050L	FC4E-T060L	FC4E-T070L	FC4E-T080L
4-pipe - Right connection (PAW-)			FC4E-T010R	FC4E-T020R	FC4E-T030R	FC4E-T040R	FC4E-T050R	FC4E-T060R	FC4E-T070R	FC4E-T080R
Total cooling capacity ¹⁾	Lo/Med/Hi	kW	0,5/1,1/1,9	0,6/1,2/2,2	0,8/1,9/2,9	1,2/2,7/4,0	1,2/3,6/4,6	1,8/4,1/4,9	2,6/5,1/6,4	5,0/6,2/9,6
Sensible capacity ¹⁾	Lo/Med/Hi	kW	0,4/0,9/1,7	0,4/1,0/1,8	0,6/1,5/2,2	0,9/1,9/2,8	1,0/2,8/3,5	1,2/3,2/3,8	1,9/3,8/4,8	3,6/4,6/7,2
Water flow	Lo/Med/Hi	l/h	92/185/327	97/206/375	129/321/493	205/457/681	212/625/686	306/707/749	443/886/977	855/1070/1242
Water pressure drop	Lo/Med/Hi	kPa	5,8/20,1/59,2	1,3/3,7/9,7	4,0/9,2/19,7	6,3/29,6/60,1	2,5/17,9/21,3	5,1/24,3/27,2	3,5/13,6/16,5	22,9/33,9/44,3
Heating capacity ²⁾	Lo/Med/Hi	kW	0,4/0,8/1,4	0,6/0,9/1,5	1,0/1,4/1,8	1,2/2,0/2,8	1,6/2,4/2,5	1,4/2,9/3,1	2,5/3,4/3,6	4,5/5,9/6,9
Water flow	Lo/Med/Hi	l/h	76/140/235	95/161/255	166/243/304	204/350/483	267/416/438	233/503/531	434/583/614	767/1011/1194
Water pressure drop	Lo/Med/Hi	kPa	1,8/4,0/8,4	1,4/3,8/9,4	5,3/9,7/14,1	15,6/41,8/76,3	11,9/26,3/28,9	11,5/43,6/48,1	61,5/103,8/113,9	42,1/69,7/95,1
Sound levels										
Global sound power	Lo/Med/Hi	dB(A)	34/47/60	34/47/60	31/50/59	29/44/52	30/51/57	32/54/58	40/54/59	51/56/64
Global sound pressure ³⁾	Lo/Med/Hi	dB(A)	25/38/51	25/38/51	22/41/50	20/35/43	21/42/48	23/45/49	31/45/50	42/47/55
Fan										
Number			1	1	1	2	2	2	2	3
Air flow 2-pipe	Lo/Med/Hi	m ³ /h	108/228/417	98/234/413	145/380/585	170/412/678	203/645/816	245/737/912	350/850/1050	685/927/1398
Air flow 4-pipe	Lo/Med/Hi	m ³ /h	91/199/379	84/200/380	123/342/540	148/369/627	185/587/646	205/668/716	329/798/894	660/884/1079
Filter			G2	G2	G2	G2	G2	G2	G2	G2
Electrical data										
Power supply	Voltage	V	230	230	230	230	230	230	230	230
	Phase		Single phase	Single phase	Single phase	Single phase	Single phase	Single phase	Single phase	Single phase
	Frequency	Hz	50/60	50/60	50/60	50/60	50/60	50/60	50/60	50/60
Consumption 2-pipe	Lo/Med/Hi	W	5/11/41	5/13/41	4/16/42	2/13/43	4/24/46	2/30/54	11/44/77	23/42/108
Consumption 4-pipe	Lo/Med/Hi	W	5/11/39	5/13/40	6/15/40	2/12/42	2/23/44	2/28/52	11/43/75	22/41/116
Water connections										
Type			Female gas threaded	Female gas threaded	Female gas threaded	Female gas threaded	Female gas threaded	Female gas threaded	Female gas threaded	Female gas threaded
2-pipe	Inch		1/2	1/2	1/2	1/2	1/2	1/2	3/4	3/4
4-pipe	Cool	Inch	1/2	1/2	1/2	1/2	1/2	1/2	3/4	3/4
	Heat	Inch	1/2	1/2	1/2	1/2	1/2	1/2	1/2	1/2
Dimension and weight										
Dimension	H x W x D	mm	225 x 766 x 477	225 x 766 x 477	225 x 951 x 477	225 x 1136 x 477	225 x 1321 x 477	225 x 1506 x 477	225 x 1319 x 477	225 x 1506 x 477
Weight	2 / 4-pipes	kg	19/20	19/20	22/23	27/29	30/32	35/37	35/37	47/49

1) According to Eurovent standard. Air: 27 °C DB / 19 °C WB. Water in / out: 7 °C / 12 °C. 2) Air: 20 °C. Water in / out: 50 °C / 45 °C. 3) The sound pressure levels are based on [NR] characteristics of a room having volume of 100 m³ with reverberation of 0,5 seconds.

Technical focus

- Cooling capacity: 0,5 to 9,6 kW
- Heating capacity: 0,6 to 13,6 kW
- Low energy consumption EC fan(s)

Main features and accessories

- 2 and 4-pipe configurations
- Left or right hand arrangements
- Ease of installation
- Very low acoustic levels
- 2 way or 3 way ON / OFF valves
- Auxiliary drain pan
- Air intake with removable grid
- G2 filter

Operating limits

Entering water temperature	From 5 to 90 °C
Indoor air temperature	From 5 to 32 °C



Fan coils - floor-standing chassis (AC)



Optional controller.
Advanced wired remote controller.
PAW-FC-RC1



Optional controller.
Wired remote controller with touch control.
PAW-FC-907AC



Optional controller.
Wired remote controller.
PAW-FC-903AC

2-pipe - Left connection (PAW-)		FC2A-P010L	FC2A-P020L	FC2A-P030L	FC2A-P040L	FC2A-P050L	FC2A-P060L	FC2A-P070L	FC2A-P080L	
2-pipe - Right connection (PAW-)		FC2A-P010R	FC2A-P020R	FC2A-P030R	FC2A-P040R	FC2A-P050R	FC2A-P060R	FC2A-P070R	FC2A-P080R	
Total cooling capacity ¹⁾	Lo/Med/Hi kW	0,7/1,0/1,5	0,7/1,2/1,7	1,0/2,0/2,5	1,2/2,4/3,2	1,7/3,2/4,6	2,7/4,6/5,8	3,4/6,1/7,3	4,6/6,1/8,1	
Sensible capacity ¹⁾	Lo/Med/Hi kW	0,5/0,8/1,1	0,6/0,9/1,3	0,8/1,5/1,9	0,9/1,8/2,3	1,2/2,2/3,3	1,9/3,3/4,5	2,4/4,3/5,1	3,4/4,6/6,3	
Water flow	Lo/Med/Hi l/h	124/172/250	127/213/289	172/341/430	206/413/547	296/544/798	466/784/1003	587/1058/1252	798/1048/1400	
Water pressure drop	Lo/Med/Hi kPa	10,7/19,5/39,2	1,9/3,9/6,3	6,3/19,3/28,8	5,4/17,1/28,0	7,5/22,8/46,9	13,9/37,4/60,2	4,8/15,4/21,5	11,9/19,3/32,5	
Heating capacity ²⁾	Lo/Med/Hi kW	0,9/1,4/2,0	0,9/1,5/2,2	1,3/2,4/3,1	1,4/2,9/4,0	2,1/4,1/5,7	3,1/5,3/7,1	4,3/7,9/9,3	5,9/8,1/11,6	
4-pipe - Left connection (PAW-)		FC4A-P010L	FC4A-P020L	FC4A-P030L	FC4A-P040L	FC4A-P050L	FC4A-P060L	FC4A-P070L	FC4A-P080L	
4-pipe - Right connection (PAW-)		FC4A-P010R	FC4A-P020R	FC4A-P030R	FC4A-P040R	FC4A-P050R	FC4A-P060R	FC4A-P070R	FC4A-P080R	
Total cooling capacity ¹⁾	Lo/Med/Hi kW	0,7/0,9/1,3	0,6/1,1/1,6	1,0/1,9/2,4	1,1/2,3/3,0	1,7/3,0/4,3	2,6/4,4/5,6	3,3/5,9/6,9	4,5/5,9/8,0	
Sensible capacity ¹⁾	Lo/Med/Hi kW	0,5/0,7/1,0	0,5/0,8/1,2	0,8/1,5/1,8	0,8/1,7/2,2	1,2/2,2/3,1	1,8/3,2/4,3	2,3/4,2/4,9	3,3/4,4/6,2	
Water flow	Lo/Med/Hi l/h	114/159/225	109/192/268	165/327/414	194/388/517	284/522/748	449/756/967	575/1019/1193	775/1020/1380	
Water pressure drop	Lo/Med/Hi kPa	8,3/15,2/29,0	1,5/3,4/5,6	3,0/9,5/14,4	6,4/22,3/36,8	4,2/12,8/25,1	10,2/27,7/44,5	5,9/17,9/24,4	19,3/31,1/53,6	
Heating capacity ²⁾	Lo/Med/Hi kW	0,5/0,7/1,0	0,6/0,9/1,1	1,0/1,4/1,6	0,9/1,6/2,1	1,5/2,3/3,0	1,9/2,9/3,7	2,7/3,6/4,3	3,9/5,6/7,1	
Water flow	Lo/Med/Hi l/h	79/127/178	100/146/190	164/232/274	160/273/354	251/401/508	325/505/633	456/626/736	673/963/1226	
Water pressure drop	Lo/Med/Hi kPa	1,9/3,5/5,6	1,5/3,2/5,3	5,1/9,0/11,9	9,2/26,5/42,7	10,7/24,6/29,5	20,3/43,9/52,9	67,2/117,9/137,8	33,1/63,7/75	
Sound levels										
Global sound power	Lo/Med/Hi dB(A)	33/40/49	31/43/50	30/45/52	30/44/51	34/46/56	38/51/58	43/56/61	50/55/64	
Global sound pressure ³⁾	Lo/Med/Hi dB(A)	24/31/40	22/34/41	21/36/43	21/35/42	25/37/47	29/42/49	34/47/52	41/46/55	
Fan										
Number		1	1	1	2	2	2	2	3	
Air flow 2-pipe	Lo/Med/Hi m ³ /h	111/190/283	105/179/265	138/274/390	173/357/499	253/486/716	350/640/933	480/893/1064	660/936/1397	
Air flow 4-pipe	Lo/Med/Hi m ³ /h	95/168/253	89/161/241	132/263/369	162/335/467	242/466/671	334/614/885	470/859/1012	634/905/1370	
Filter		G2	G2	G2	G2	G2	G2	G2	G2	
Electrical data										
Power supply	Voltage	V	230	230	230	230	230	230	230	
	Phase		Single phase	Single phase	Single phase	Single phase	Single phase	Single phase	Single phase	
	Frequency	Hz	50/60	50/60	50/60	50/60	50/60	50/60	50/60	
Consumption 2-pipe	Lo/Med/Hi W	13/24/36	10/18/29	16/37/45	15/37/56	28/55/72	37/75/105	53/100/147	90/112/188	
Consumption 4-pipe	Lo/Med/Hi W	13/24/36	10/18/28	16/37/44	15/37/55	28/54/70	37/74/104	53/99/145	90/112/188	
Water connections										
Type		Female gas threaded	Female gas threaded	Female gas threaded	Female gas threaded	Female gas threaded	Female gas threaded	Female gas threaded	Female gas threaded	
2-pipe	Cool	Inch	1/2	1/2	1/2	1/2	1/2	3/4	3/4	
	Heat	Inch	1/2	1/2	1/2	1/2	1/2	1/2	1/2	
4-pipe	Cool	Inch	1/2	1/2	1/2	1/2	1/2	3/4	3/4	
	Heat	Inch	1/2	1/2	1/2	1/2	1/2	1/2	1/2	
Dimension and weight										
Dimension ⁴⁾	H x W x D	mm	477 x 766 x 225	477 x 766 x 225	477 x 951 x 225	477 x 1136 x 225	477 x 1321 x 225	477 x 1506 x 225	575 x 1319 x 225	575 x 1506 x 225
Weight	2 / 4-pipes	kg	19/20	19/20	22/23	27/29	30/32	35/37	35/37	47/49

1) According to Eurovent standard. Air: 27 °C DB / 19 °C WB. Water in / out: 7 °C / 12 °C. 2) Air: 20 °C. Water in / out: 50 °C / 45 °C. 3) The sound pressure levels are based on (NR) characteristics of a room having volume of 100 m³ with reverberation of 0,5 seconds. 4) Without support feet.

Technical focus

- Cooling capacity: 0,7 to 8,1 kW
- Heating capacity: 0,7 to 10,3 kW
- 5-speed AC fan motor(s)

Main features and accessories

- 2 and 4-pipe configurations
- Left or right hand arrangements
- Ease of installation
- Very low acoustic levels
- 2 way or 3 way ON / OFF valves
- Auxiliary drain pan
- Air intake with removable grid
- G2 filter
- PAW-FC-FSF feet for floor-standing units

Operating limits

Entering water temperature	From 5 to 90 °C
Indoor air temperature	From 5 to 32 °C



Fan coils - floor-standing chassis (EC)



Optional controller.
Wired remote controller
with touch control.
PAW-FC-907EC



Optional controller.
Wired remote controller.
PAW-FC-903EC

2-pipe - Left connection (PAW-)			FC2E-P010L	FC2E-P020L	FC2E-P030L	FC2E-P040L	FC2E-P050L	FC2E-P060L	FC2E-P070L	FC2E-P080L
2-pipe - Right connection (PAW-)			FC2E-P010R	FC2E-P020R	FC2E-P030R	FC2E-P040R	FC2E-P050R	FC2E-P060R	FC2E-P070R	FC2E-P080R
Total cooling capacity ¹⁾	Lo/Med/Hi	kW	0,6/1,2/2,1	0,6/1,4/2,4	0,9/2,1/3,1	1,3/2,9/4,2	1,3/4,0/5,0	2,0/4,5/5,2	2,7/5,9/6,9	5,1/6,5/8,8
Sensible capacity ¹⁾	Lo/Med/Hi	kW	0,5/1,1/1,9	0,5/1,1/1,9	0,6/1,6/2,4	1,0/2,1/3,0	1,1/3,0/3,7	1,4/3,5/4,0	2,0/4,3/5,2	3,7/4,8/6,6
Water flow	Lo/Med/Hi	l/h	107/210/356	110/237/406	148/354/532	230/506/722	231/685/743	341/767/800	463/1008/1098	879/1111/1254
Water pressure drop	Lo/Med/Hi	kPa	8,2/28,2/76,9	1,5/4,6/11,0	5,0/20,5/42,1	6,4/24,4/46,3	4,9/35,1/41,0	7,8/35,8/38,8	3,0/14,0/16,6	14,1/21,4/26,6
Heating capacity ²⁾	Lo/Med/Hi	kW	0,8/1,6/2,9	0,9/1,9/3,3	1,0/2,2/3,4	1,4/3,0/5,3	1,7/5,2/5,5	2,3/5,9/6,1	3,8/7,3/8,2	6,2/8,0/9,3
4-pipe - Left connection (PAW-)			FC4E-P010L	FC4E-P020L	FC4E-P030L	FC4E-P040L	FC4E-P050L	FC4E-P060L	FC4E-P070L	FC4E-P080L
4-pipe - Right connection (PAW-)			FC4E-P010R	FC4E-P020R	FC4E-P030R	FC4E-P040R	FC4E-P050R	FC4E-P060R	FC4E-P070R	FC4E-P080R
Total cooling capacity ¹⁾	Lo/Med/Hi	kW	0,5/1,1/1,9	0,6/1,2/2,2	0,8/1,9/2,9	1,2/2,7/4,0	1,2/3,6/4,6	1,8/4,1/4,9	2,6/5,1/6,4	5,0/6,2/9,6
Sensible capacity ¹⁾	Lo/Med/Hi	kW	0,4/0,9/1,7	0,4/1,0/1,8	0,6/1,5/2,2	0,9/1,9/2,8	1,0/2,8/3,5	1,2/3,2/3,8	1,9/3,8/4,8	3,6/4,6/7,2
Water flow	Lo/Med/Hi	l/h	92/185/327	97/206/375	129/321/493	205/457/681	212/625/686	306/707/749	443/886/977	855/1070/1242
Water pressure drop	Lo/Med/Hi	kPa	5,8/20,1/59,2	1,3/3,7/9,7	4,0/9,2/19,7	6,3/29,6/60,1	2,5/17,9/21,3	5,1/24,3/27,2	3,5/13,6/16,5	22,9/33,9/44,3
Heating capacity ²⁾	Lo/Med/Hi	kW	0,4/0,8/1,4	0,6/0,9/1,5	1,0/1,4/1,8	1,2/2,0/2,8	1,6/2,4/2,5	1,4/2,9/3,1	2,5/3,4/3,6	4,5/5,9/6,9
Water flow	Lo/Med/Hi	l/h	76/140/235	95/161/255	166/243/304	204/350/483	267/416/438	233/503/531	434/583/614	767/1011/1194
Water pressure drop	Lo/Med/Hi	kPa	1,8/4,0/8,4	1,4/3,8/9,4	5,3/9,7/14,1	15,6/41,8/76,3	11,9/26,3/28,9	11,5/43,6/48,1	61,5/103,8/113,9	42,1/69,7/95,1
Sound levels										
Global sound power	Lo/Med/Hi	dB(A)	34/47/60	34/47/60	31/50/59	29/44/52	30/51/57	32/54/58	40/54/59	51/56/64
Global sound pressure ³⁾	Lo/Med/Hi	dB(A)	25/38/51	25/38/51	22/41/50	20/35/43	21/42/48	23/45/49	31/45/50	42/47/55
Fan										
Number			1	1	1	2	2	2	2	3
Air flow 2-pipe	Lo/Med/Hi	m ³ /h	108/228/417	98/234/413	145/380/585	170/412/678	203/645/816	245/737/912	350/850/1050	685/927/1398
Air flow 4-pipe	Lo/Med/Hi	m ³ /h	91/199/379	84/200/380	123/342/540	148/369/627	185/587/646	205/668/716	329/798/894	660/884/1079
Filter			G2	G2	G2	G2	G2	G2	G2	G2
Electrical data										
Power supply	Voltage	V	230	230	230	230	230	230	230	230
	Phase		Single phase	Single phase	Single phase	Single phase	Single phase	Single phase	Single phase	Single phase
	Frequency	Hz	50/60	50/60	50/60	50/60	50/60	50/60	50/60	50/60
Consumption 2-pipe	Lo/Med/Hi	W	5/11/41	5/13/41	4/16/42	2/13/43	4/24/46	2/30/54	11/44/77	23/42/108
Consumption 4-pipe	Lo/Med/Hi	W	5/11/39	5/13/40	6/15/40	2/12/42	2/23/44	2/28/52	11/43/75	22/41/116
Water connections										
Type			Female gas threaded	Female gas threaded	Female gas threaded	Female gas threaded	Female gas threaded	Female gas threaded	Female gas threaded	Female gas threaded
2-pipe	Inch		1/2	1/2	1/2	1/2	1/2	1/2	3/4	3/4
4-pipe	Cool	Inch	1/2	1/2	1/2	1/2	1/2	1/2	3/4	3/4
	Heat	Inch	1/2	1/2	1/2	1/2	1/2	1/2	1/2	1/2
Dimension and weight										
Dimension ⁴⁾	H x W x D	mm	477 x 766 x 225	477 x 766 x 225	477 x 951 x 225	477 x 1136 x 225	477 x 1321 x 225	477 x 1506 x 225	575 x 1319 x 225	575 x 1506 x 225
Weight	2 / 4-pipes	kg	19/20	19/20	22/23	27/29	30/32	35/37	35/37	47/49

1) According to Eurovent standard. Air: 27 °C DB / 19 °C WB. Water in / out: 7 °C / 12 °C. 2) Air: 20 °C. Water in / out: 50 °C / 45 °C. 3) The sound pressure levels are based on (NR) characteristics of a room having volume of 100 m³ with reverberation of 0,5 seconds. 4) Without support feet.

Technical focus

- Cooling capacity: 0,5 to 9,6 kW
- Heating capacity: 0,6 to 13,6 kW
- Low energy consumption EC fan(s)

Main features and accessories

- 2 and 4-pipe configurations
- Left or right hand arrangements
- Ease of installation
- Very low acoustic levels
- 2 way or 3 way ON / OFF valves
- Auxiliary drain pan
- Air intake with removable grid
- G2 filter
- PAW-FC-FSF feet for floor-standing units

Operating limits

Entering water temperature	From 5 to 90 °C
Indoor air temperature	From 5 to 32 °C



Fan coils - wall-mounted (AC)



Optional controller.
Advanced wired remote
controller.
PAW-FC-RC1



Optional controller.
Wired remote controller
with touch control.
PAW-FC-907AC



Optional controller.
Wired remote controller.
PAW-FC-903AC



Infrared remote supplied
with IR versions.
IR Controller



2-pipe			PAW-FC2A-K007	PAW-FC2A-K009	PAW-FC2A-K018	PAW-FC2A-K022
			PAW-FC2A-K007IR	PAW-FC2A-K009IR	PAW-FC2A-K018IR	PAW-FC2A-K022IR
Total cooling capacity ¹⁾	Lo/Med/Hi	kW	1,0/1,3/1,7	1,6/1,7/2,4	2,8/3,0/3,5	2,9/3,1/3,9
Sensible capacity ¹⁾	Lo/Med/Hi	kW	0,7/1,0/1,2	1,2/1,3/1,9	2,1/2,3/2,7	2,3/2,5/3,1
Water flow	Lo/Med/Hi	l/h	172/231/287	270/291/418	483/508/609	502/535/669
Water pressure drop	Lo/Med/Hi	kPa	18,6/24,9/30,9	18,5/27,0/40,0	34,6/41,3/55,6	37,2/33,7/45,2
Heating capacity ²⁾	Lo/Med/Hi	kW	1,4/1,7/2,0	1,7/2,0/2,7	2,9/3,2/4,0	3,1/3,7/4,4
Sound levels						
Sound power	Lo/Med/Hi	dB(A)	45/49/51	47/52/57	49/53/59	56/59/63
Sound pressure ³⁾	Lo/Med/Hi	dB(A)	32/36/38	34/39/44	40/43/46	43/46/50
Fan						
Number			1	1	1	1
Air flow	Lo/Med/Hi	m ³ /h	282/321/360	367/413/551	532/592/680	617/709/850
Filter			G1	G1	G1	G1
Electrical data						
Power supply	Voltage	V	230	230	230	230
	Phase		Single phase	Single phase	Single phase	Single phase
	Frequency	Hz	50	50	50	50
Fuse rating		A	3	3	3	3
Consumption	Lo/Med/Hi	W	39/42/62	30/47/59	44/50/55	50/55/70
Water connections						
Type			Female gas threaded	Female gas threaded	Female gas threaded	Female gas threaded
Water connections		Inch	1/2	1/2	1/2	1/2
Dimension and weight						
Dimension	HxWxD	mm	275 x 180 x 845	275 x 180 x 845	298 x 200 x 940	298 x 200 x 940
Weight		kg	11	11	13	13

1) According to Eurovent standard. Air: 27 °C DB / 19 °C WB. Water in / out: 7 °C / 12 °C. 2) According to Eurovent standard. Air: 20 °C. Water in / out: 45 °C / 40 °C. 3) Sound pressure considering a local of 100 m³ a reverberation time of 0,5 seconds and a distance of 1 m.

Technical focus

- 4 sizes
- Cooling capacity: 1,0 to 3,9 kW
- Heating capacity: 1,4 to 4,1 kW
- Version: 2-pipes, AC fan

Main features and accessories

- 2 way or 3 way valve ON / OFF
- 3-speed AC fan motor
- Silent unit for optimum customer comfort
- Aesthetic design suitable for residential and hotel applications
- Compatible with IR controller (supplied with IR versions)
- Coil with hydrophilic fins to improve the condensate flow

* The electric movement of the flaps is available for the IR version.

Operating limits

Entering water temperature	From 5 to 60 °C
Indoor air temperature	From 6 to 40 °C



Smart fan coils



Built-in advanced thermostat.

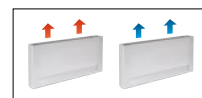

			PAW-AAIR-200-2	PAW-AAIR-700-2	PAW-AAIR-900-2	NEW PAW-AAIR-1100-2
Total cooling capacity	Lo/Med/Hi	kW	0,3/0,5/0,6	0,6/0,9/1,5	0,8/1,6/2,1	0,9/1,8/2,5
Sensible capacity	Lo/Med/Hi	kW	0,2/0,4/0,6	0,5/0,9/1,3	0,7/1,3/1,9	0,9/1,6/2,3
Water flow	Lo/Med/Hi	kg/h	51,1/89,4/106,3	96,0/155,2/251,1	140,8/267,2/365,7	158,1/300,3/423,6
Water pressure drop	Lo/Med/Hi	kPa	3,3/5,7/6,1	1,1/2,1/4,2	1,5/5,8/10,3	1,3/5,0/10,6
Inlet water temperature		°C	10	10	10	10
Outlet water temperature		°C	15	15	15	15
Inlet air temperature		°C	27	27	27	27
Outlet air temperature	Lo/Med/Hi	°C	12,8/13,2/14,9	14,6/14,8/14,0	15,8/14,6/14,4	18,1/15,2/14,7
Relative humidity of inlet air		%	47	47	47	47
Total heating capacity	Lo/Med/Hi	kW	0,2/0,4/0,5	0,4/0,8/1,2	0,6/1,2/1,6	0,8/1,4/2,1
Water flow	Lo/Med/Hi	kg/h	38,4/70,5/92,8	72,7/139,2/201,6	114,0/204,2/284,5	138,3/243,2/356,7
Water pressure drop	Lo/Med/Hi	kPa	1,0/2,3/3,0	0,5/1,5/3,1	1,0/3,3/6,6	1,1/3,1/7,3
Inlet water temperature		°C	35	35	35	35
Outlet water temperature		°C	30	30	30	30
Inlet air temperature		°C	19	19	19	19
Outlet air temperature	Lo/Med/Hi	°C	33,5/33,3/30,9	30,1/31,4/31,8	30,1/31,1/31,2	26,6/29,5/30,5
Air flow	Lo/Med/Hi	m ³ /min	0,9/1,9/2,7	2,6/4,2/5,3	4,1/6,1/7,7	6,2/7,6/9,6
Maximum input power	Lo/Med/Hi	W	7,0/9,0/13,0	14,0/18,0/22,0	16,0/20,0/24,0	18,0/22,0/26,5
Sound pressure	Lo/Med/Hi	dB(A)	24/33/39	25/34/40	25/34/42	26/35/43
Dimension (HxWxD)		mm	735x579x129	935x579x129	1135x579x129	1335x579x129
Net weight		kg	17	20	23	26
3 Ways valve included			Yes	Yes	Yes	Yes
Touch screen thermostat			Yes	Yes	Yes	Yes

* Smart fan coils is produced by Innova.

Accessories

PAW-AAIR-LEGS-1 Kits of 2 legs to protect the water pipings

Accessories

PAW-AAIR-RHCABLE Motor connection cable for units with hydraulic connections on the right

Stylish floor-standing fan coils with advanced controller

The slimline of Smart fan coils delivers high efficiency climate control.

With a depth of just under 130 mm they are at the cutting edge of the market. Blending easily into the home, Smart fan coil's elegant design and product refinements are clear to see in every detail.

Exceptional ventilation efficiency means the motor uses considerably less energy (low wattage). The fan speed is continuously modulated by the temperature controller with proportional integral logic, with undoubted advantages for regulating the temperature and humidity in summer mode.

Technical focus

- 4 operation modes (auto, silent, night-time and maximum ventilation speed)
- Exclusive design
- Extremely compact (only 129 mm deep)
- Cooling and dehumidification functions possible (drain is needed)
- 3-way valve included (no overflow valve needed on the installation if more than 3 units installed)
- Touch screen thermostat

With standard cast radiators.

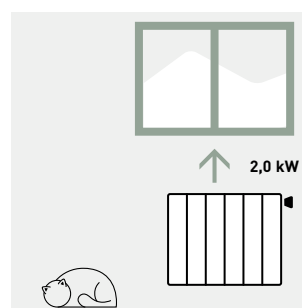

Water at 65 °C needed.

With Smart fan coil.

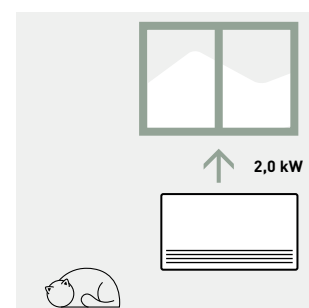

Water at 35 °C needed.

All temperature curves and capacity are available on www.panasonicproclub.com

PRO Club



Control and connectivity

Simple user friendly control for outdoor units

A control panel with intuitive design is equipped on all ECOi-W systems as standard. The microprocessor based control has a IHM logic and implements a smart handling for your demand.

Basic operation.

- ON / OFF setting
- Cooling / Heating mode setting

Energy Saving.

- Intelligent logic control for inlet water temperature
- Night setback operation to reduce electrical consumption and noise
- Part load operating mode
- Maximum discharge temperature control

Service / Maintenance.

- Automatic test operation at the push of a button
- Alarm notice with the latest 10 alarms
- Counter for operating hours of compressor and pump
- Compressor operating limits saved in a flash memory

Others.

- BMS compatible (RS485 ModBus RTU or BACnet MSTP protocol)



Remote control kit

PAW-SYSREMKIT for R410A models.

PAW-SYSREMKIT1 for R32 models.

Simple remote control for the need to be installed remotely from the units.

Features:

- 8 lines of display with selectable blue and white back light
- Push-and-roll knob for easy operation
- Schedule function
- Alarm button with LED indicator
- Firmware can be upgraded via USB interface



Remote monitoring service ECOi-W Cloud

PAW-CM000SP041

Remote access in real time to optimise the service and maintenance work.

Alarm notification via e-mail.

Reporting and graph visualization up to 300 variables.

Various LED signals on the hardware to check the status on site.

Technical focus:

- Maximum 10 outdoor units connectable
- Modbus RTU is required
- History of data interval up to 5 minutes
- 4G SIM card fitted
- IP65 casing
- Optional antenna is available to improve signal coverage



New cascade control - Plug & Play solution

PAW-CSC-L22-01

All the components such as an electronic board, a power supply and a protection switch are enclosed in one casing and ready to use without additional accessories.

Technical focus:

- Cascade up to 8 ECOi-W outdoor units
- Fully compatible with ECOi-W R32 and R410A Series
- Ready to be integrated with ECOi-W Cloud (PAW-CM000SP041)
- RS485 terminal equipped to integrate with Building Management Systems
- Optimized control for defrosting and domestic hot water (DHW)
- Backup and rotation control available
- Flexible control of external water pumps (up to 2 external pumps)
- Dimension (H x W x D): 469,6 x 425,6 x 145,9 mm
- Weight: 5,85 kg



Wired controllers for AC and EC fan coils

Advanced wired remote controller (AC)

PAW-FC-RC1

This advanced controller provides a higher level of comfort in heating. The sensor can be used as a water flow sensor, stopping the fan when the water temperature is low, avoiding cold drafts in winter.

Features:

- For 2-pipe and 4-pipe, AC fan
- Change Over function (cold draft prevention)
- Room thermostat
- 3 outputs, 230 V relays for fan control
- 2 outputs, 230 V relays for heating / cooling control
- Connection to BMS - Modbus RTU slave
- 1 DI for presence detection (key card switch)
- 1 AI for sensor



Wired remote controller (AC/EC)

Stylish and sophisticated design with backlit LCD display, is suitable for installation within a wide variety of locations such as office, hotel and residential applications. By connecting the controller to the range of AC/EC fan coils, the user can take advantage of the improved performance, higher levels of efficiency and thus improved energy savings.

PAW-FC-907AC

Features:

- For 2-pipe, AC fan
- Back lit LCD screen with touch control
- 3 speed control relay, for fan
- Economizer

PAW-FC-907EC

Features:

- For 2-pipe and 4-pipe, EC fan
- Back lit LCD screen with touch control
- Adjustable range EC fan control
- Economizer
- Connection to BMS via Modbus
- 1 DI for presence detection (key card switch)



Wired remote controller (AC/EC)

Feature rich and perfectly adapted to control AC/EC fan coils, the PAW-FC-903AC/EC is the addition for any fan coil. With intuitive user interface provided by the push button control and large LCD display, it will fit seamlessly with almost any location.

PAW-FC-903AC

Features:

- For 2-pipe, AC fan
- Back lit LCD screen
- 3 speed control relay, for fan
- Economizer

PAW-FC-903EC

Features:

- For 2-pipe and 4-pipe, EC fan
- Back lit LCD screen
- Adjustable range EC fan control
- Economizer
- Connection to BMS via Modbus
- 1 DI for presence detection (key card switch)



Accessories and control

Wired remote controller for outdoor units



Remote control for the need to be installed remotely from the units for R410A models.

PAW-SYSREMKIT

Remote control for the need to be installed remotely from the units for R32 models.

PAW-SYSREMKIT1

Cascade control



NEW Cascade control - Plug & Play solution.

PAW-CSC-L22-01

Remote monitoring service ECOi-W Cloud



Remote antenna to improve signal coverage.

PAW-CM000K0001



Cloudgate Plug & Play IP65 box mobile 4G Europe.

PAW-CM000SP041

ECOi-W Cloud

ECOi-W Cloud service fee.
Prepaid subscription for 1 year.

PAW-00SRTS011

Shut off valves



Shut off valves kit for R32 models 50 - 75.

PAW-SYSSOV4

Shut off valves kit for R32 models 85 - 170.

PAW-SYSSOV5

Shut off valves kit for R410A models 20 - 40.

PAW-SYSSOV1

Victaulic® connection kit



Victaulic® connection kit for model 140 - 210.

PAW-SYSVICTH

Wired remote controller for fan coil



Advanced wired remote controller for fan coil.

PAW-FC-RC1



Wired remote controller with touch control for 2-pipe and 4-pipe, EC fan coil (control + Modbus).

PAW-FC-907EC

Wired remote controller with touch control for 2-pipe, AC fan coil (control only).

PAW-FC-907AC



Wired remote controller for 2-pipe and 4-pipe, EC fan coil (control + Modbus).

PAW-FC-903EC

Wired remote controller for 2-pipe, AC fan coil (control only).

PAW-FC-903AC

Fan coil ceiling, floor-standing and ducted valve accessories

2 way valve + drain pan for 2-pipe ceiling, floor-standing and ducted models 010-060. ----- PAW-FC-2WY-11/55-1	2 way valve + drain pan for 2-pipe ceiling, floor-standing and ducted models 070-080. ----- PAW-FC-2WY-65/90-1	2 way valve + drain pan for 2-pipe ducted model F040. ----- PAW-FC-2WY-F040
3 way valve + drain pan for 2-pipe ceiling, floor-standing and ducted models 010-060. ----- PAW-FC-3WY-11/55-1	3 way valve + drain pan for 2-pipe ceiling, floor-standing and ducted models 070-080. ----- PAW-FC-3WY-65/90-1	3 way valve + drain pan for 2-pipe ducted model F040. ----- PAW-FC-3WY-F040
2 way valve + drain pan for 4-pipe ceiling, floor-standing and ducted models 010-060. ----- PAW-FC4-2WY-010	2 way valve + drain pan for 4-pipe ceiling, floor-standing and ducted models 070-080. ----- PAW-FC4-2WY-070	2 way valve + drain pan for 4-pipe ducted model F040. ----- PAW-FC4-2WY-F040
3 way valve + drain pan for 4-pipe ceiling, floor-standing and ducted model 010. ----- PAW-FC4-3WY-010	3 way valve + drain pan for 4-pipe ceiling, floor-standing and ducted models 020-060. ----- PAW-FC4-3WY-020	3 way valve + drain pan for 4-pipe ceiling, floor-standing and ducted models 070-080. ----- PAW-FC4-3WY-070
3 way valve + drain pan for 4-pipe ducted model F040. ----- PAW-FC4-3WY-F040		

Fan coil high static ducted valve accessories

2 way valve + drain pan for 2-pipe high static ducted model E070. ----- PAW-FC2-2WY-E070	2 way valve + drain pan for 2-pipe high static ducted models E150-E180. ----- PAW-FC-2WY-150	2 way valve + drain pan for 2-pipe high static ducted models E210-E240. ----- PAW-FC2-2WY-E210
3 way valve + drain pan for 2-pipe high static ducted model E070. ----- PAW-FC2-3WY-E070	3 way valve + drain pan for 2-pipe high static ducted models E150-E180. ----- PAW-FC-3WY-150	3 way valve + drain pan for 2-pipe high static ducted models E210-E240. ----- PAW-FC2-3WY-E210
2 way valve + drain pan for 4-pipe high static ducted model E070. ----- PAW-FC4-2WY-E070	2 way valve + drain pan for 4-pipe high static ducted models E150-E180. ----- PAW-FC4-2WY-E150	2 way valve + drain pan for 4-pipe high static ducted models E210-E240. ----- PAW-FC4-2WY-E210
3 way valve + drain pan for 4-pipe high static ducted model E070. ----- PAW-FC4-3WY-E070	3 way valve + drain pan for 4-pipe high static ducted models E150-E180. ----- PAW-FC4-3WY-E150	3 way valve + drain pan for 4-pipe high static ducted models E210-E240. ----- PAW-FC4-3WY-E210

Fan coil cassette accessories

2 way valve + drain pan for 2-pipe cassette models U020-U040. ----- PAW-FC2-2WY-U020	2 way valve + drain pan for 2-pipe cassette models U050-U070. ----- PAW-FC2-2WY-U050	3 way valve + drain pan for 2-pipe cassette models U020-U040. ----- PAW-FC2-3WY-U020	3 way valve + drain pan for 2-pipe cassette models U050-U070. ----- PAW-FC2-3WY-U050
2 way valve + drain pan for 4-pipe cassette models U020-U040. ----- PAW-FC4-2WY-U020	2 way valve + drain pan for 4-pipe cassette models U050-U070. ----- PAW-FC4-2WY-U050	3 way valve + drain pan for 4-pipe cassette models U020-U040. ----- PAW-FC4-3WY-U020	3 way valve + drain pan for 4-pipe cassette models U050-U070. ----- PAW-FC4-3WY-U050
Panel 720 x 720 mm for cassette models U020-U040. ----- PAW-FC-KPY2040	Panel 960 x 960 mm for cassette models U050-U070. ----- PAW-FC-KPU5070		

Fan coil wall-mounted valve accessories

2 way valve for 2-pipe wall-mounted K007-K022. ----- PAW-FC2-2WY-K007	3 way valve for 2-pipe wall-mounted K007-K022. ----- PAW-FC2-3WY-K007
--	--

Smart fan coil accessories

Kits of 2 legs to protect the water pipings. ----- PAW-AAIR-LEGS-1	Motor connection cable for units with hydraulic connections on the right. ----- PAW-AAIR-RHCABLE
---	---



CO₂ condensing units - CR Series with natural refrigerant

Panasonic's CO₂ condensing units - CR Series provide the ideal solution for supermarkets, convenience stores and gas stations.

Keeping food always fresh at right temperature in showcases or cold rooms is a very critical point. And one of the biggest challenges for those retailers has been the expensive effects of refrigeration breakdowns which can result in costly product wastage.

PACi NX Elite can cool rooms down to 8 °C

Panasonic PACi NX Elite offers a high quality and efficient solution for high temperature refrigeration applications for facilities such as wine cellars, food processing facilities and supermarkets.

Choose the sustainable green solution by Panasonic → 476

Natural solution with high energy saving → 478

A sustainable refrigeration systems in your food retail → 480

The safe refrigeration systems for your healthcare business → 481

CO₂ transcritical condensing units - CR Series → 482

Technology by Panasonic → 484

Control and connectivity → 486

Range of CO₂ condensing units - CR Series → 488

CO₂ Condensing units - CR Series → 489

Panasonic PACi NX Elite can cool rooms down to 8 °C → 490

Bringing nature's balance indoors → 492

PACi NX Series Elite wall-mounted · R32 → 494

PACi NX Series Elite 4 way 90x90 cassette · R32 → 495

PACi NX Series Elite ceiling · R32 → 496



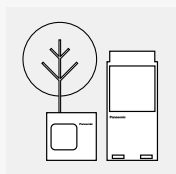
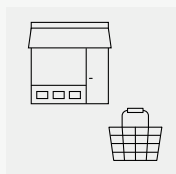



PACi NX Series Elite adaptive ducted unit · R32 → 497



Choose the sustainable green solution by Panasonic

Environmentally friendly CO₂ condensing units - CR Series and medium temperature solutions with PACi NX R32.



CO ₂ condensing units - CR Series					Medium temperature solutions with PACi NX
MT/LT Type	MT Type	MT/LT Type	MT Type	MT/LT Type	
					
Capacity range (kW)					Capacity range (kW)
4 (MT) / 2 (LT)	7,5	8 (MT) / 4 (LT)	15	16 (MT) / 8 (LT)	2,1 to 23,2
Low temperature					Low temperature
✓	—	✓	—	✓	—
Medium temperature					Medium temperature
—	✓	✓	—	✓	✓
High Temperature					High Temperature
—	—	—	—	—	✓
Heat recovery port					Heat recovery port
—	✓	✓	—	✓	—
ET (Evaporation Temperature) set points range					Room temp. set point
-45 ~ -5 °C	-20 ~ -5 °C	-45 ~ -5 °C	-20 ~ -5 °C	-45 ~ -5 °C	+8 ~ +24 °C WB
Room size example (m³)*					Room size example (m³)*
40 (MT) / 10 (LT)	80	80 (MT) / 20 (LT)	200	200 (MT) / 50 (LT)	From 6

* Room size is reference. Please contact to authorized Panasonic dealer for calculation.

Energy saving



Natural CO₂ / R744.

R744 refrigerant provides higher energy saving and lower CO₂ emission compared to R404A. Zero ODP and GWP=1 means natural substance.



R32 refrigerant.

Our heat pumps containing R32 refrigerant show a drastic reduction in the value of Global Warming Potential (GWP). An important step to reduce greenhouse gases. R32 is also a component refrigerant, making it easy to recycle.



Inverter Plus System.

Inverter Plus System classification highlights Panasonic's highest performing systems.



High efficiency compressor.

Powerful 2-stage CO₂ rotary compressor by Panasonic. It delivers high performance all year around.

High performance and indoor air quality



Super quiet.

Systems operate extremely quiet. Minimum 33 dB(A) @10 m with OCU-CR400VF8(SL).



Operating range up to 43 °C.

The system operates up to 43 °C, allowing for installation in various locations.



Anti corrosion coating.

Selectable fin type with or without an anti corrosion coating. The anti corrosion coating prevents salt damage for a longer lifespan.



Heat recovery port.

The heat recovery port is available to cut running costs as optional. By utilizing exhausted heat generated by refrigeration to the energy source for heating.



Automatic fan operation.

Microprocessor control automatically adjusts the outdoor fan speed in CO₂ systems for efficient operation.



5 Years compressor warranty.

We guarantee the outdoor unit compressors in the entire range for five years.

High connectivity



BMS connectivity.

The system can be supervised with major monitoring system.

Why CO₂? Natural refrigerant.

EU F-Gas regulation is a key priority for European countries. It ensures compliance with the Kigali Amendment supporting international climate commitments on greenhouse gases and leading the global transition to climate-friendly HFC-free technologies. Carbon dioxide (R744) is regaining its place in the refrigeration world. Driven by environmental concerns, legislation now requires increased adoption of 'alternative' refrigerants, such as CO₂. CO₂ is an environmentally-friendly solution, with zero ODP and "GWP" (Global Warming Potential)=1 means natural substance in the atmosphere.

In Europe a step-by-step HFC reduction has been in place since the F-Gas regulation was introduced in 2015. Countries all over the world have actively been preparing to enact the necessary domestic legislation to implement the agreement to reduce the use of HFCs. Panasonic is now able to provide a solution in Europe with CO₂ refrigeration systems to prevent global warming and to support environment-friendly retail operations. The following table shows how well R744 (CO₂) performs regarding environmental impact and safety.

ODP (Ozone Depletion Potential) = 0 - GWP (Global Warming Potential) = 1

	Next generation refrigerant			Current refrigerant	
	CO ₂	Ammonia	Isobutane	R410A	R404A
ODP	0	0	0	0	0
GWP	1	0	4	2090	3920
Flammability	Non flammable	Light flammable	Flammable	Non flammable	Non flammable
Toxicity	No	Yes	No	No	No

Comparison of CO₂ emissions

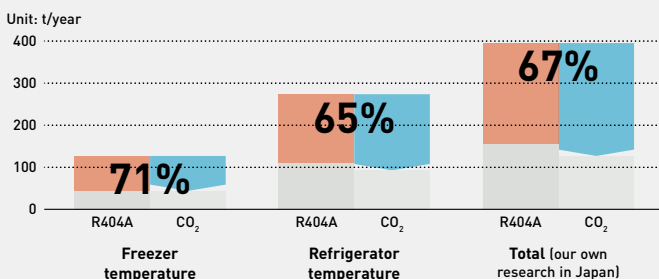

Energy saving
25,4% Freezer
16,2% Refrigeration

CO₂ emission
67% Reduction

Direct influence ¹⁾ Indirect influence ²⁾

1) Direct influence presents the effect of refrigerant leakage comparing R744 (CO₂) with R404A.
2) Indirect influence presents CO₂ emissions linked to power consumption of CO₂ unit and conventional units.
By Panasonic research in Japan. Comparing 6 shops average for R404A Inverter multi condensing unit.

Natural solution with high energy saving

Panasonic's range of CO₂ condensing units - CR Series with natural refrigerant, and R32 complete systems for HT applications offer a reliable solution for a wide range of applications, including convenience stores, supermarket, gas stations and cold rooms.



Showcases.

Convenience stores, supermarkets, gas-stations.

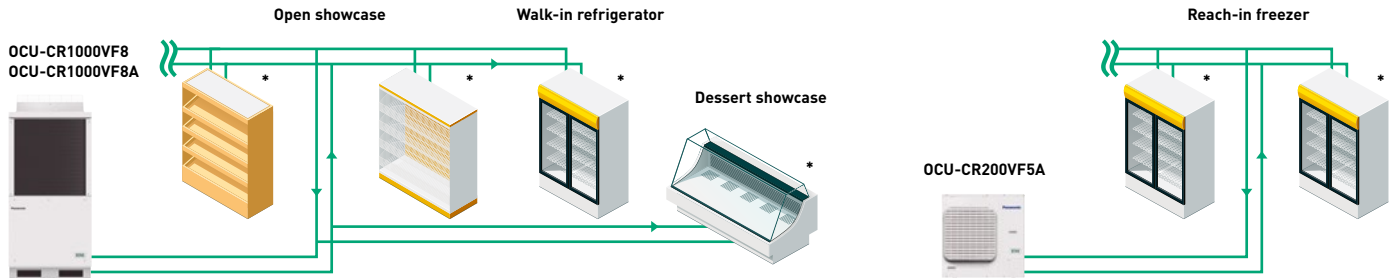
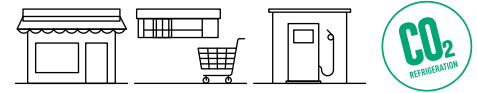

* Controllers: PAW-CO2-PANEL-C or local supply.

Cold room application to keep food fresh

Multiple installation capabilities. Unparalleled flexibility:

- Food retail applications (convenience store, supermarkets, gas-stations)
- Food service applications (restaurants, canteens, schools)
- Non-food applications (warehousing, industrial storage, healthcare)

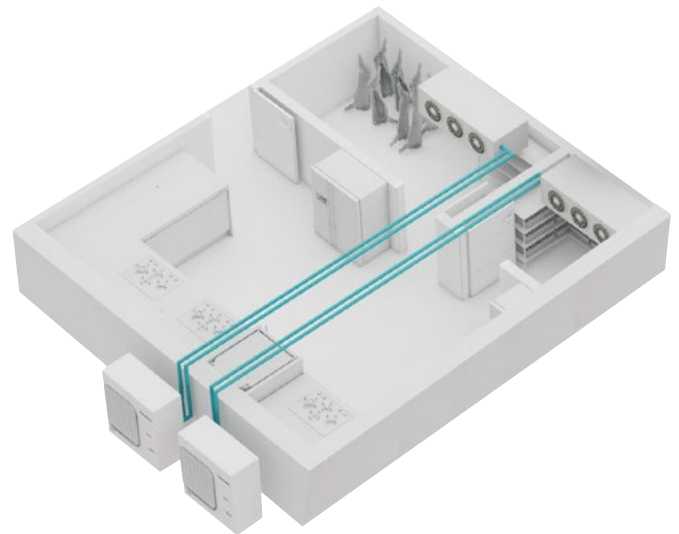
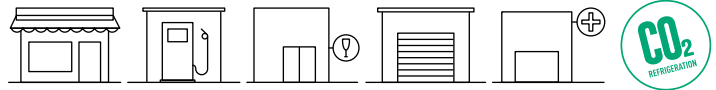

Cold room application integrated with PACi NX Series

Panasonic offers various solutions for cold rooms by combining a wide range of products. Integrated with PACi NX Series, it allows for flexible design and installation.

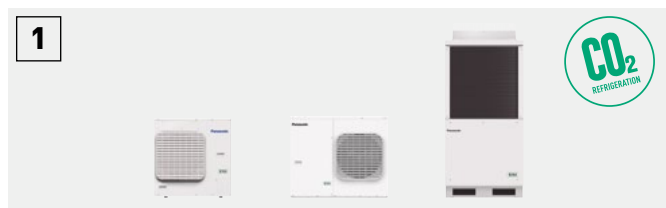

CO₂ condensing units - CR Series for refrigerated room.



PACi NX Series for cooling rooms between 8 °C WB and 24 °C.

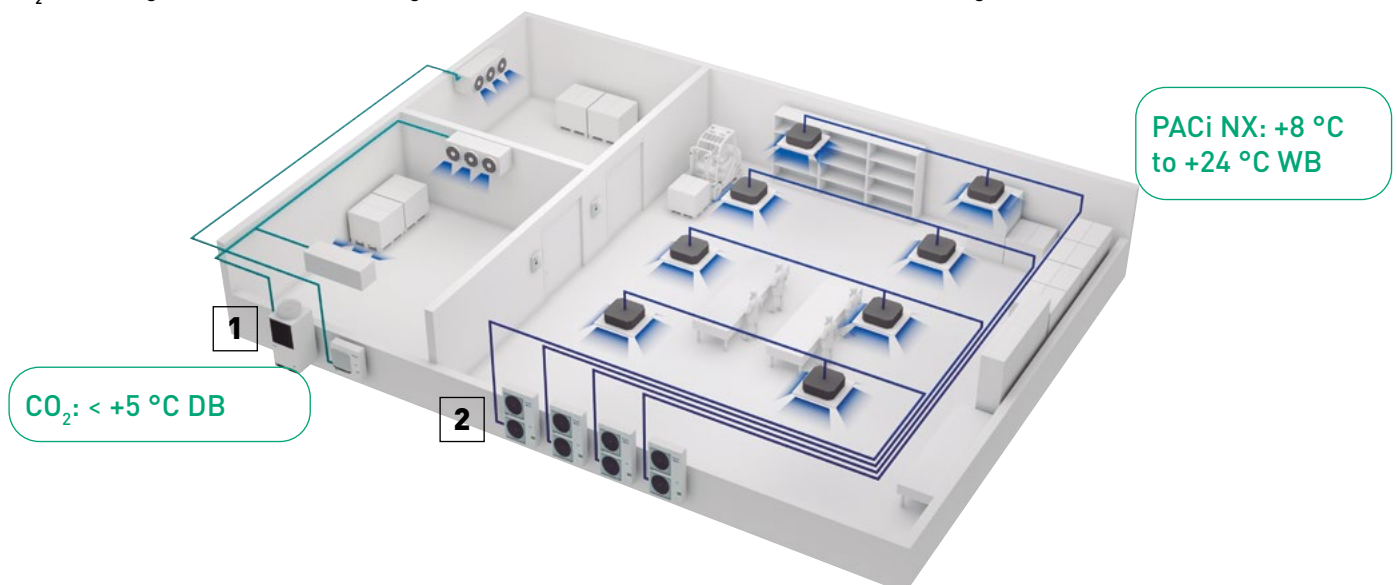

A sustainable refrigeration systems in your food retail

CO₂ refrigerant is the choice to curb carbon footprint of any business organization, especially to food retailers, to whom it brings key advantages.

Panasonic professional strongly supports your projects to meet customer's request!

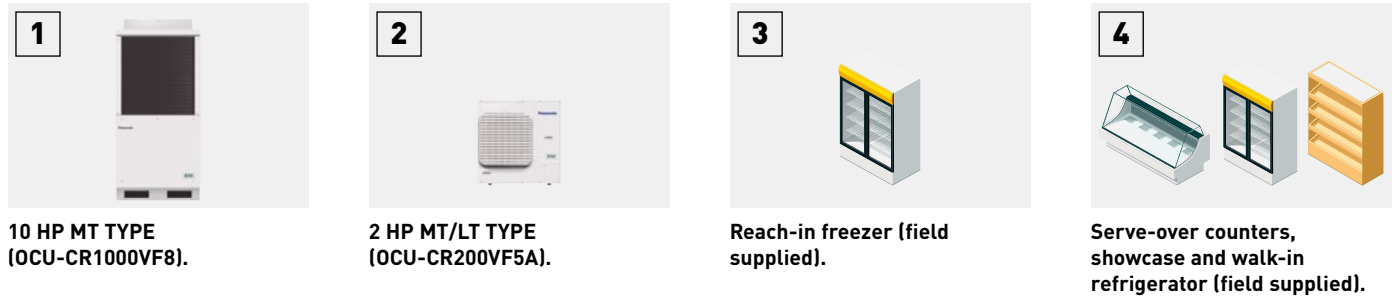

1
10 HP MT TYPE
(OCU-CR1000VF8).

2
2 HP MT/LT TYPE
(OCU-CR200VF5A).

3
Reach-in freezer (field supplied).

4
Serve-over counters,
showcase and walk-in
refrigerator (field supplied).

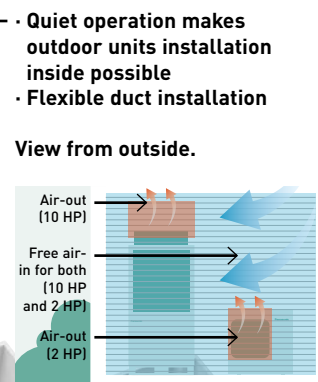
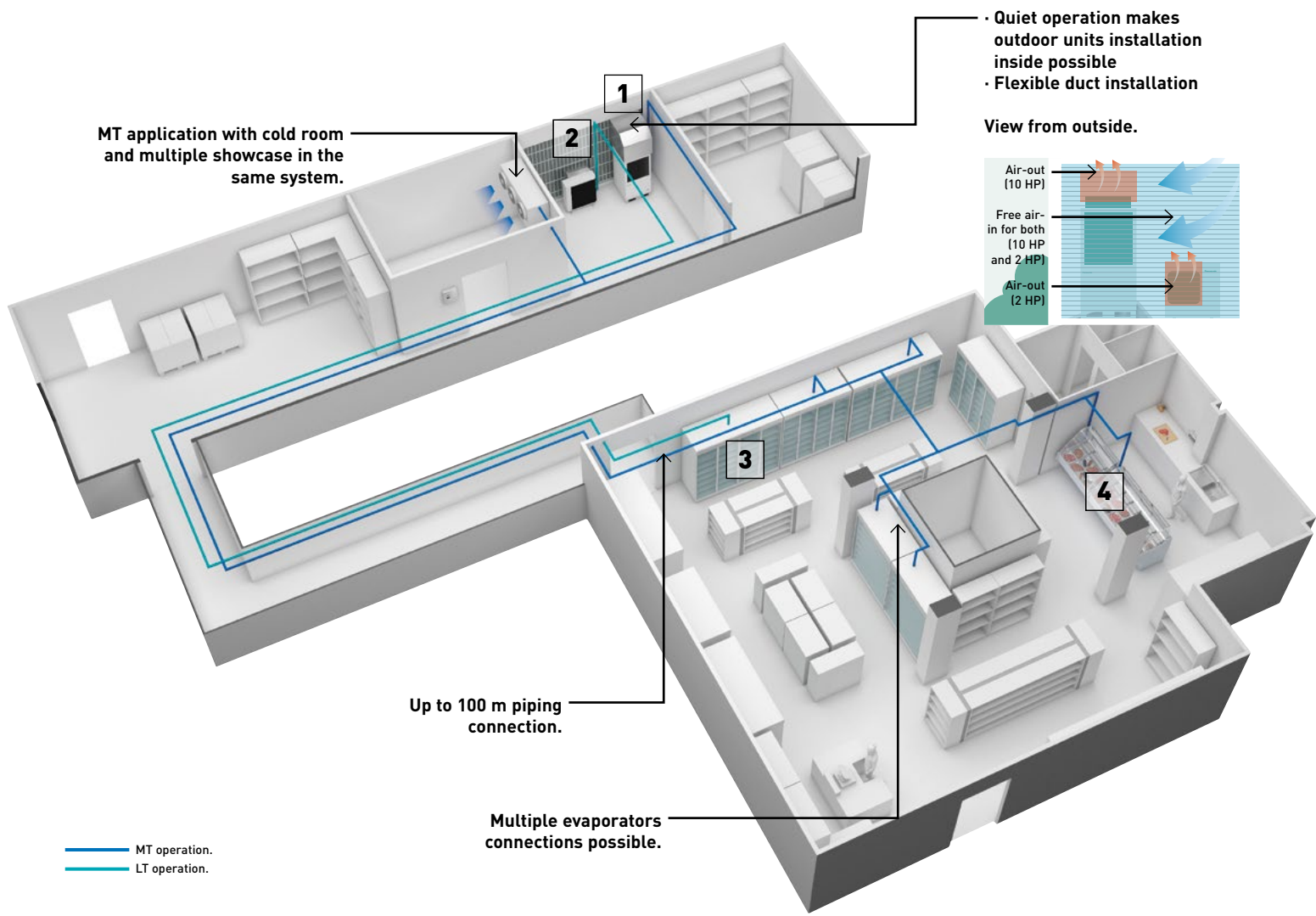

— MT operation.
— LT operation.

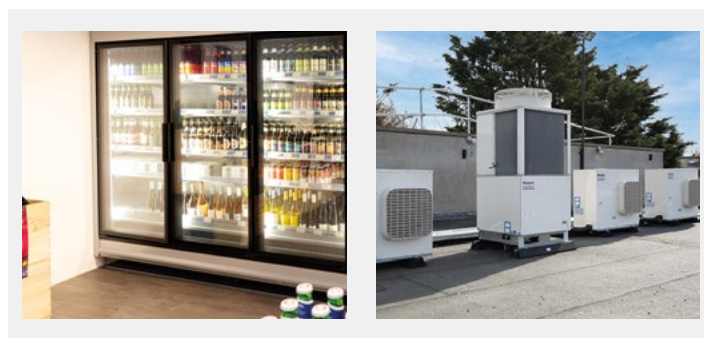

Nolan's Supermarket.
Nolan's Supermarket celebrated its 60th year in business with an extension and full refurbishment which completely overhauled the existing store. A particular focus of the project was to create a state-of-the-art refrigeration system operating on the 'Zero Ozone Depletion' plus ultralow GWP of 1 natural refrigerant CO₂ and as part of the scheme. Panasonic CO₂ condensing units - CR Series have been chosen because of the high performance and reliable quality.

The safe refrigeration systems for your healthcare business

CO₂ is the right refrigerant to curb carbon footprint of any business organization. In addition, there are advantages specially for healthcare business. The project example shows one of the warehouse in the healthcare laboratory which requires several cold rooms there to keep bio-products safely.



1
10 HP LT TYPE
(OCU-CR1000VF8A).



2
10 HP MT TYPE
(OCU-CR1000VF8).

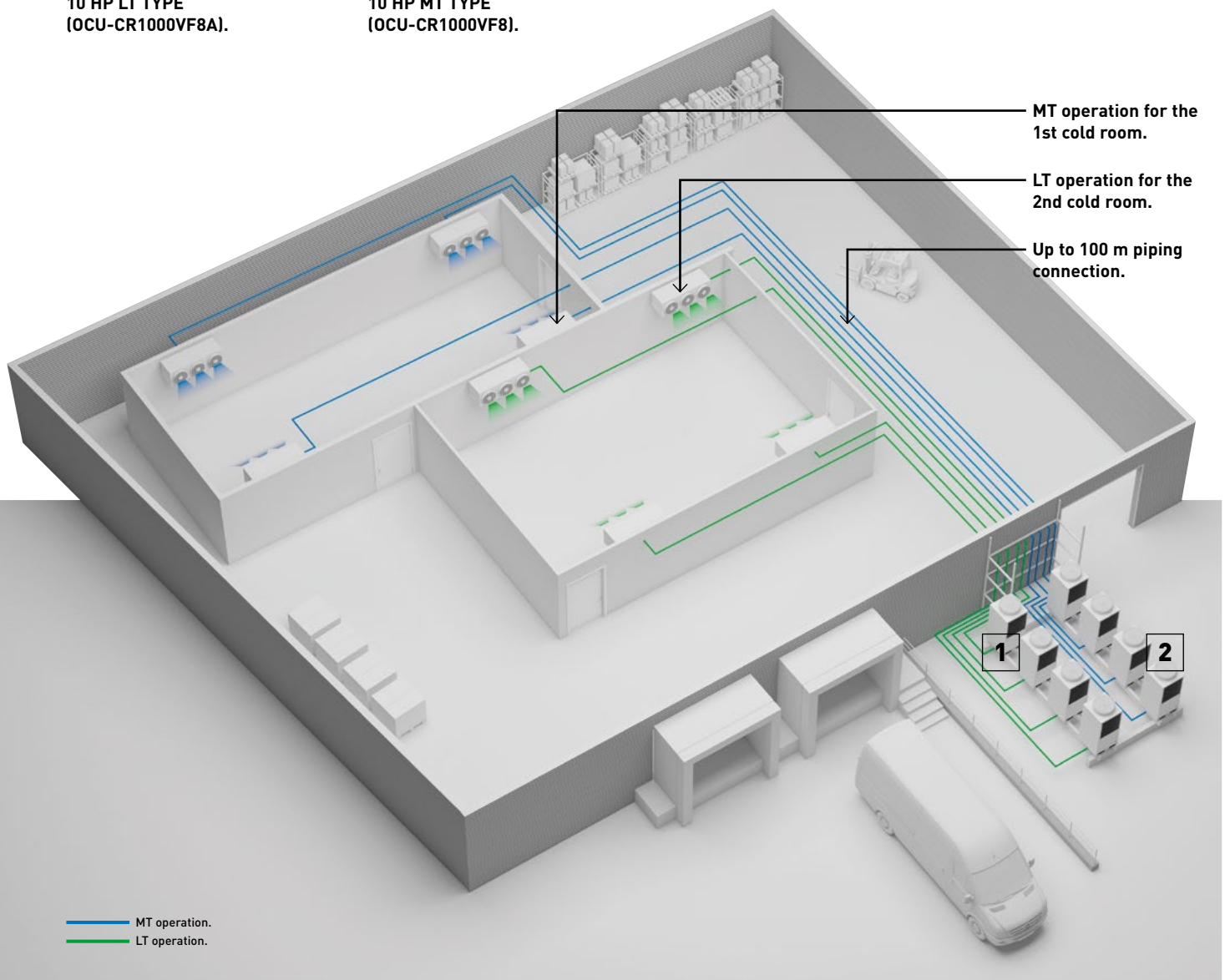

STEMCELL Technologies.

STEMCELL Technologies is a global biotechnology company that develops, manufactures and sells products and provides services that support academic and industrial scientists. Panasonic CO₂ condensing units - CR Series have been chosen to fulfill the expectation of environmental-friendly and safety requirements. The products with reliable quality and high performance was also an essential point.

CO₂ transcritical condensing units - CR Series

CR Series offer a wide range of refrigeration systems, meeting the specific needs of small retail stores.



1 Superior efficiency with reliable quality

- Panasonic has combined the 2-stage compressor with the split cycle for increased efficiency
- High seasonal performance. SEPR: Maximum 3,83 in cooling, 1,92 in freezing¹⁾
- High COP at high ambient temperature

1) 200VF5A.

2 Flexible installation

- Set-points at medium or low temperature available depending on applications
- Compact unit
- Silent operation
- Long piping length: Maximum 100 m²⁾
- High external static pressure²⁾
- Transfer pressure control for stable electric expansion valve control in showcases²⁾

2) 1000VF8/8A.

3 Heat recovery port as renewable energy

- Maximum 16,7 kW of heating for free
- Optional possibility to get subsidy (depending on location)
- Easy connection process

Superior cooling capacity at each evaporating temperature

CO₂ transcritical condensing units - CR Series have a high cooling capacity at each set point. The CO₂ 2-stage compressor developed by Panasonic is designed to compress CO₂ refrigerant twice; it reduces the load in operation by half (compared to 1-stage refrigerant compression) and delivers increased durability and reliability. Units can be programmed to run at low and medium temperatures at initial set-up. These settings can then be modified by turning a simple and user friendly rotary switch to further enhance energy savings.

MT/LT TYPE
200VF5A - 4 kW / 2 kW

MT TYPE
400VF8 - 7,5 kW

MT TYPE
1000VF8 - 15 kW

MT/LT TYPE
400VF8A - 8 kW / 4 kW

MT/LT TYPE
1000VF8A - 16 kW / 8 kW

3,83
SEPR
cooling*

1,92
SEPR
freezing*

* SEPR values has been tested at 3-part laboratory.

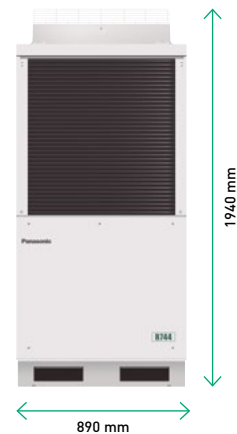
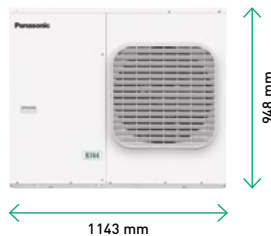
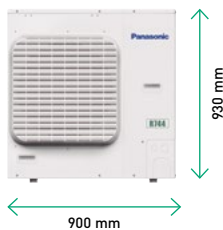

OCU-CR400VF8(SL)²⁾
Cooling capacity (kW)

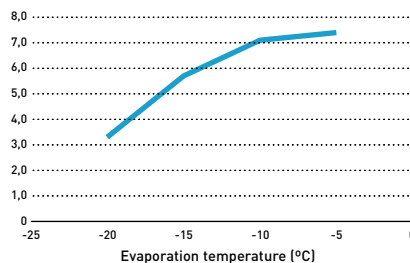

OCU-CR1000VF8(SL)²⁾
Cooling capacity (kW)

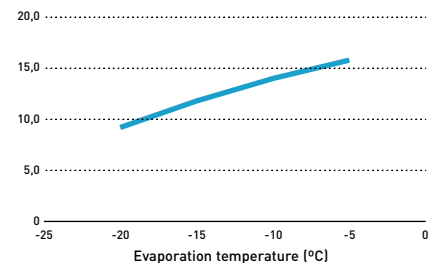

OCU-CR200VF5A(SL)¹⁾
Cooling capacity (kW)

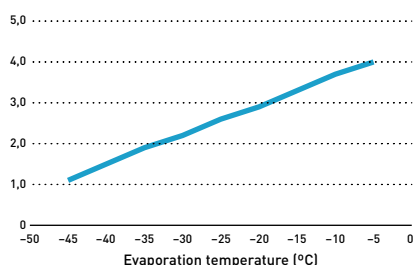

OCU-CR400VF8A(SL)²⁾
Cooling capacity (kW)

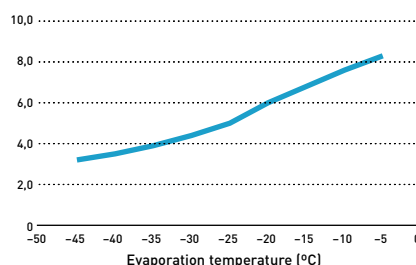

OCU-CR1000VF8A(SL)²⁾
Cooling capacity (kW)

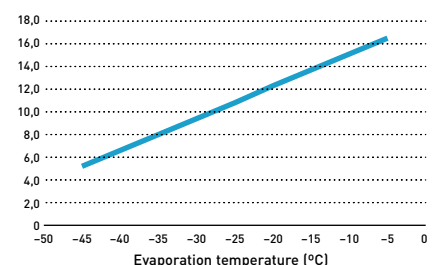

1) Ambient temperature: 32 °C, 230 V, refrigerant: R744, suction gas temperature: 18 °C. 2) Ambient temperature: 32 °C, 400 V, refrigerant: R744, suction gas temperature: 18 °C.

Technology by Panasonic

Excellent quality control established by skilled factory team.

Reliability is our main target and therefore we offer compressor warranties of 5 years, and 2 year warranties on other components!



Reliable CO₂ technology by Panasonic

- Reliable quality: Made in Japan
- 15000 units sold and installed in more than 4000 retail operations such as convenience stores and supermarkets in Japan*
- Excellent quality control established by skilled factory team
- Panasonic offers 5 year warranties on compressors and 2 years on components
- The 5 year compressor warranty matches the products long lifespan

* As of the end of December 22.

Panasonic's combined technology of the 2-stage compressor with the split cycle.

- Panasonic 2-stage rotary compressor delivering powerful performance for more than 20 years
- Split cycle* enhances cooling effect

* Available for 200VF5A, 400VF8A and 1000VF8A models.

** In the case that the standard cycle with 1-stage rotary compressor was compared.

The video for detailed information is ready!

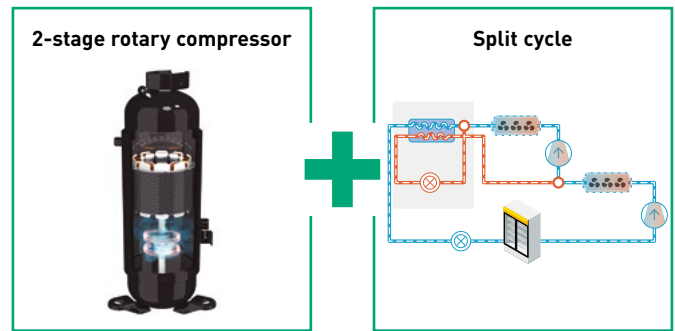

Standard cycle.

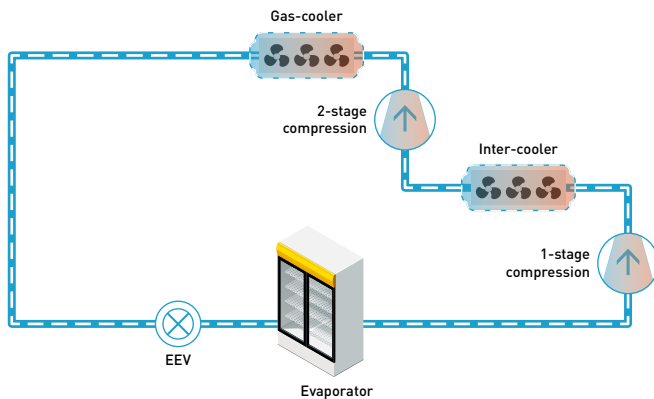

Split cycle.

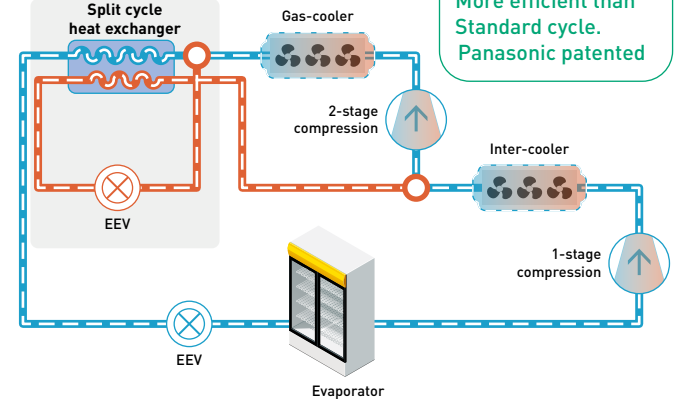

Heat recovery function for heating

This function offers refrigeration combined with heating all in one system. The ground-breaking solution allows for increased opportunity to cut running costs by utilizing exhausted heat from refrigeration and transferring to the energy source for heating.

16,7 kW¹⁾
Of hot water
for free

What is heat recovery function?

Solution example.

Heat recovery system can produce both heating and refrigeration.

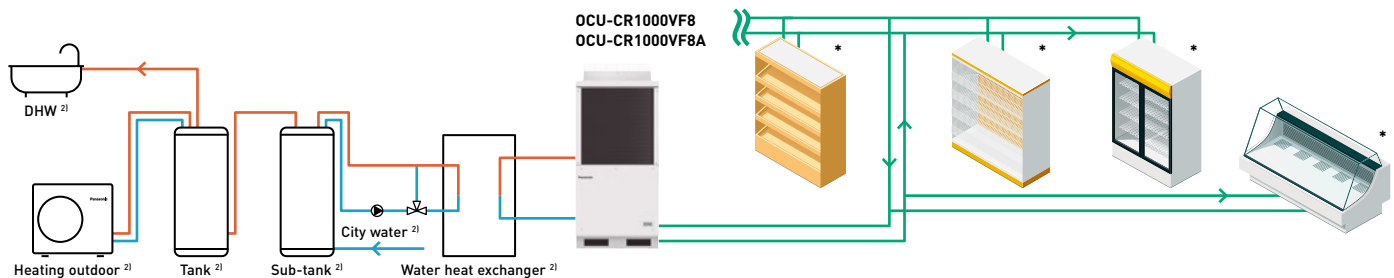

1) Under the condition: ambient temperature 32 °C, evaporation temperature -10 °C. 100% Partial load. 2) Local supply.

* Controllers: PAW-CO2-PANEL-C or local supply.

Refrigeration designer available in Panasonic PRO Club.

This simple design tool supports engineers, installers, and technicians to make a quick calculation for commercial refrigeration systems.

- Evaporation temperature selection
- Cooling capacity calculator
- Refrigerant pipe calculation
- Electric expansion valves calculation
- Refrigerant amount calculation

Ready to works on all devices, computers, tablets and smartphones!!

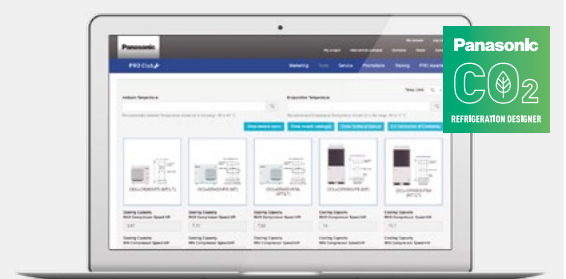

PRO Club

www.panasonicproclub.com or
connect simply with your smartphone
to the PRO Club using this QR



Control and connectivity

Panasonic CO₂ condensing units - CR Series is optimized with Panel-C intelligent controller and a service checker for professionals. It can be easily integrated with major monitoring systems.



Control panel and electric expansion valves.

Panel-C, an intelligent controller with a compact chassis. This controller has the smart program especially for showcases and cold rooms. Electric expansion valves (EEVs) are ready with 7 different sizes to meet precisely the field demand and it's delivered with Panel-C as a kit.

Intelligent controller with compact chassis. Panel-C.

- MPXPRO control fully pre-programmed for MT and LT on the same panel
- Compact structure size: 300 x 220 x 120 mm
- Necessary cables, EEV stator, temperature and pressure probes as standard equipment
- Ultracap technology as standard equipment for emergency EEV's closing in the event of mains power failure
- Smart defrost functions, advanced superheat control, light and showcase curtain management, etc
- Own display user terminal plus keypad for programming, built-in switching power supply, Modbus, etc
- Management of HACCP alarms

Electric expansion valves (EEVs) line-up.

- EEV's E2V-CW with 3/8" ODF copper fittings for high pressure applications (CO₂)
- Operation refrigerant temperature: -40 T 70 °C
- Maximum operating pressure for all the models 03, 05, 09, 11, 14, 18, 24 (MOP) 140 barg
- Maximum operating pressure difference for 03, 05, 09, 11, 14, 18, (MOPD) 120 bar and 24 (MOPD) 85 bar
- Bipolar stator hermetic IP69K as standard equipment (supplied on panel)
- Mechanical strainer as standard equipment (500 mm mesh)
- Equipercetile control particularly effective at partial load with reliable operation even after 1,2 billion steps

* Please refer the model references in page 489.



CO₂ service checker

PAW-CO2-CHECKER

The service checker is a useful tool which supports your technical tasks on the field such as commissioning, maintenance and troubleshooting for Panasonic CO₂ condensing units - CR Series.

Main features:

- Reading and recording variable technical parameters
- Main technical parameters available*: pressures, temperatures, opening of expansion valves, states of solenoid valves, rotational speeds of the gas-cooler fan motor, frequency and compressor's current, etc.
- Setting change of operating values possible
- 2D graph visualization for the detailed analysis
- Monitoring an alarm status, for example the status of the compressor oil level, etc.

* Please check all the parameters available in the manual.

To use it, is necessary to download free Device Manager software from the Eliwell website:

Visit: <https://www.eliwell.com/en/Family/DeviceManager.html> using this QR.

Eliwell product name: Device Manager 100. Eliwell part number: DMP1000002000.



eliwell
by Schneider Electric



Modbus compatibility with monitoring system

Panasonic CO₂ condensing units - CR Series can be supervised by major monitoring system such as CAREL, Eliwell, Danfoss and RDM. Monitoring system ensures the recording, monitoring and reporting of temperature conditions etc... of entire CO₂ condensing units - CR Series system at shops.

Monitoring system



Standard boss & boss-mini



AK-SM Series*



TelevisGo



DMTOUCH

* M2M1-10 gateway (Model code: FDS021) is required in addition to the monitoring system. M2M1-10 gateway is a local supply.

Range of CO₂ condensing units - CR Series

Outdoor units	MT	4,0 kW	7,0 kW	8,0 kW	15,0 kW	16,0 kW
	LT		2,0 kW		4,0 kW	

4 kW MT / LT
(200VF5A)



OCU-CR200VF5A
OCU-CR200VF5ASL

7,5 kW MT
(400VF8)

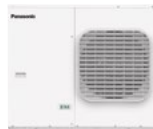

OCU-CR400VF8
OCU-CR400VF8SL

7,5 kW MT / LT
(400VF8A)

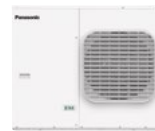

OCU-CR400VF8A
OCU-CR400VF8ASL

15 kW MT
(1000VF8)



OCU-CR1000VF8
OCU-CR1000VF8SL

16 kW MT / LT
(1000VF8A)



OCU-CR1000VF8A
OCU-CR1000VF8ASL

CO₂ condensing units - CR Series

Standard outdoor unit			OCU-CR200VF5A	OCU-CR400VF8	OCU-CR400VF8A	OCU-CR1000VF8	OCU-CR1000VF8A			
Anti corrosion coating outdoor unit			OCU-CR200VF5ASL	OCU-CR400VF8SL	OCU-CR400VF8ASL	OCU-CR1000VF8SLO	OCU-CR1000VF8ASL			
Type (MT: medium temperature, LT: low temperature)			MT (4 kW) / LT (2 kW)	MT (7,5 kW)	MT (8 kW) / LT (4 kW)	MT (15 kW)	MT (16 kW) / LT (8 kW)			
Power supply	Voltage	V	220/230/240	380/400/415	380/400/415	380/400/415	380/400/415			
	Phase		Single phase	Three phase	Three phase	Three phase	Three phase			
	Frequency	Hz	50	50	50	50	50			
Cooling capacity at ET -10 °C AT 32 °C		kW	3,70	7,10	7,7	14,00	15,10			
Cooling capacity at ET -35 °C AT 32 °C		kW	1,80	—	3,8	—	8,00			
SEPR cooling at ET -10 °C AT 32 °C			3,83	2,68	2,45	2,62	2,82			
SEPR freezing at ET -35 °C AT 32 °C			1,92	—	1,56	—	1,66			
Annual electricity consumption at ET -10 °C AT 32 °C		kWh/a	6797	16337	19302	32815	32409			
Annual electricity consumption at ET -35 °C AT 32 °C		kWh/a	8021	—	30424	—	39985			
Evaporator connection			Multiple	Multiple	Multiple	Multiple	Multiple			
Evaporation temperature	Min ~ Max	°C	-45 ~ -5	-20 ~ -5	-45 ~ -5	-20 ~ -5	-45 ~ -5			
Ambient temperature	Min ~ Max	°C	-20 ~ +43	-20 ~ +43	-20 ~ +45	-15 ~ +43	-15 ~ +43			
Refrigerant			R744	R744	R744	R744	R744			
Design pressure liquid line		Mpa	12	8	8	8	8			
Design pressure suction line		Mpa	8	8	8	8	8			
User system external alarm. Digital input. Non-voltage contact			Yes	Yes	Yes	Yes	Yes			
Liquid tube electromagnetic valve		Vac	220/230/240	220/230/240	220/230/240	220/230/240	220/230/240			
Showcase operation ON / OFF signal. Digital input. Non-voltage contact			Yes	Yes	Yes	Yes	Yes			
Modbus communication line (RS485)		Ports	Yes	Yes	Yes	Yes	Yes			
Compressor type			2- stage rotary	2- stage rotary	2- stage rotary	2- stage rotary	2- stage rotary			
Dimension	H x W x D	mm	930 x 900 x 437	948 x 1143 x 609	948 x 1143 x 609	1941 x 890 x 890	1941 x 890 x 890			
Net weight		Kg	70	136	149	293	320			
Piping diameter ¹⁾	Suction pipe	Inch (mm)	3/8 (9,52)	1/2 (12,70)	1/2 (12,70)	3/4 (19,05)	3/4 (19,05)			
	Liquid pipe	Inch (mm)	1/4 (6,35)	3/8 (9,52)	3/8 (9,52)	5/8 (15,88)	5/8 (15,88)			
Length of connection piping		m	25	50 ²⁾	50 ²⁾	100 ³⁾	100 ³⁾			
PED		CAT	I	II	II	II	II			
Air flow		m ³ /min	54	59	59	220	220			
External static pressure		Pa	17	50	50	58	58			
Heat recovery port			—	—	Yes	—	Yes			
Standard performance	Ambient temperature	°C	32	32	32	32	32			
	Evaporating temperature	°C	-10	-35	-10	-10	-35			
	Cooling capacity	kW	3,70	1,80	7,10	7,7	3,8	14,00	15,10	8,00
	Power consumption	kW	1,79	1,65	4,00	4,5	3,8	8,20	8,20	7,57
	Nominal load ampere	A	7,94	7,26	6,14	7,2	6,2	12,60	12,60	11,60
Sound pressure	dB(A)	35,5 ⁴⁾	35,5 ⁴⁾	33 ⁵⁾	36,1 ⁵⁾	36,1 ⁵⁾	36,0 ⁶⁾	36,0 ⁶⁾	36,0 ⁶⁾	
Necessary accessories										
Drier filter liquid line, Ø6,35 mm		D-152T / DCY-P12	Yes (included)	Yes (included)	Yes (included)	—	—			
Drier filter liquid line, Ø15,88 mm		D-155T / DCY-P8	—	—	—	Yes (included)	Yes (included)			
Suction filter, Ø19,05 mm (outer Ø welding)		S-008T / S-008T1	—	Yes (included)	Yes (included)	Yes (included)	Yes (included)			

1) These diameters correspond to the output of the unit. The required diameter must be calculated with Refrigeration designer available on PRO Club. 2) PZ-68S (refrigeration oil) must be added according to Refrigeration designer available on PRO Club. 3) PZ-68S (refrigeration oil) must be added if >50 m. 4) ET-10 °C, 65 S-1, 10 m from product. 5) ET-10 °C, 80 S-1, 10 m from product. 6) ET-10 °C, 60 S-1, 10 m from product.

Accessories

KIT-C02-PANEL-C-03	Panel-C + MPXPRO control, stator, probes, etc + EEV 3/8" ODF high pressure, size E2V03CWACO
KIT-C02-PANEL-C-05	Panel-C + MPXPRO control, stator, probes, etc + EEV 3/8" ODF high pressure, size E2V05CWACO
KIT-C02-PANEL-C-09	Panel-C + MPXPRO control, stator, probes, etc + EEV 3/8" ODF high pressure, size E2V09CWACO
KIT-C02-PANEL-C-11	Panel-C + MPXPRO control, stator, probes, etc + EEV 3/8" ODF high pressure, size E2V11CWACO
KIT-C02-PANEL-C-14	Panel-C + MPXPRO control, stator, probes, etc + EEV 3/8" ODF high pressure, size E2V14CWACO
KIT-C02-PANEL-C-18	Panel-C + MPXPRO control, stator, probes, etc + EEV 3/8" ODF high pressure, size E2V18CWACO
KIT-C02-PANEL-C-24	Panel-C + MPXPRO control, stator, probes, etc + EEV 3/8" ODF high pressure, size E2V24CWACO
SPK-TU125	Service adaptor for vacuum and service (HP and LP port), for 2 HP, 4 HP and 10 HP
PAW-C02-CHECKER	Service Checker for commissioning, maintenance and service, for 2 HP, 4 HP and 10 HP
CZ-C02LBROL500	Lubrication Oil PZ-68S (0,5L)*, for 2 HP, 4 HP and 10 HP

* You can find the PZ-68S oil "Safety Sheet" in the SAFETY section of our pipe selection software, available on our PRO Club platform.

Spare parts for service and maintenance

80203514138000 ¹⁾	S-008T Suction filter, Ø19,05 (outer Ø welding) for 4 HP and 10 HP
80203514139000 ²⁾	S-008T1 Suction filter, Ø19,05 (outer Ø welding) for 4 HP and 10 HP
80203513180000 ³⁾	D-155T Filter dryer, Ø5/8 (15,88) (in Ø welding) (type CO-085-S) for 10 HP
80203513187000 ⁴⁾	DCY-P8 165 S Filter dryer, Ø 5/8 (16,10) (in Ø welding) for 10 HP
80203513179000 ⁵⁾	D-152T Filter dryer, Ø1/4 (6,35) (in Ø welding) (type CO-082-S) for 2 HP and 4 HP
80203513186000 ⁶⁾	DCY-P12 092 S Filter dryer, Ø1/4 (6,40) (in Ø welding) for 2 HP and 4 HP

Compatibility relationship: 1) and 2) are compatible; 3) and 4) are compatible; 5) and 6) are compatible.
Stock availability: 1), 3) and 5) until end of stock.



Panasonic PACi NX Elite can cool rooms down to 8 °C

PACi

Panasonic PACi NX Elite offers a high quality and efficient solution for high temperature refrigeration applications for facilities such as wine cellars, food processing facilities and supermarkets.

Cooling rooms between
8 °C WB and 24 °C WB



Solutions for cold rooms. Set the room temperature to 8 °C.

Complete range from 2,1 to 23,2 kW. This unique solution is perfect for:

Wine cellars, ice cream factories, flower shops, supermarkets, grain stores, food storage, food processing, food distribution, lunchrooms, vegetable processing...

Just like all the indoor units in the PACi NX range, these units are compatible with all Panasonic control and monitoring solutions, which can be scaled from controlling a single zone to monitoring geographically distributed facilities.

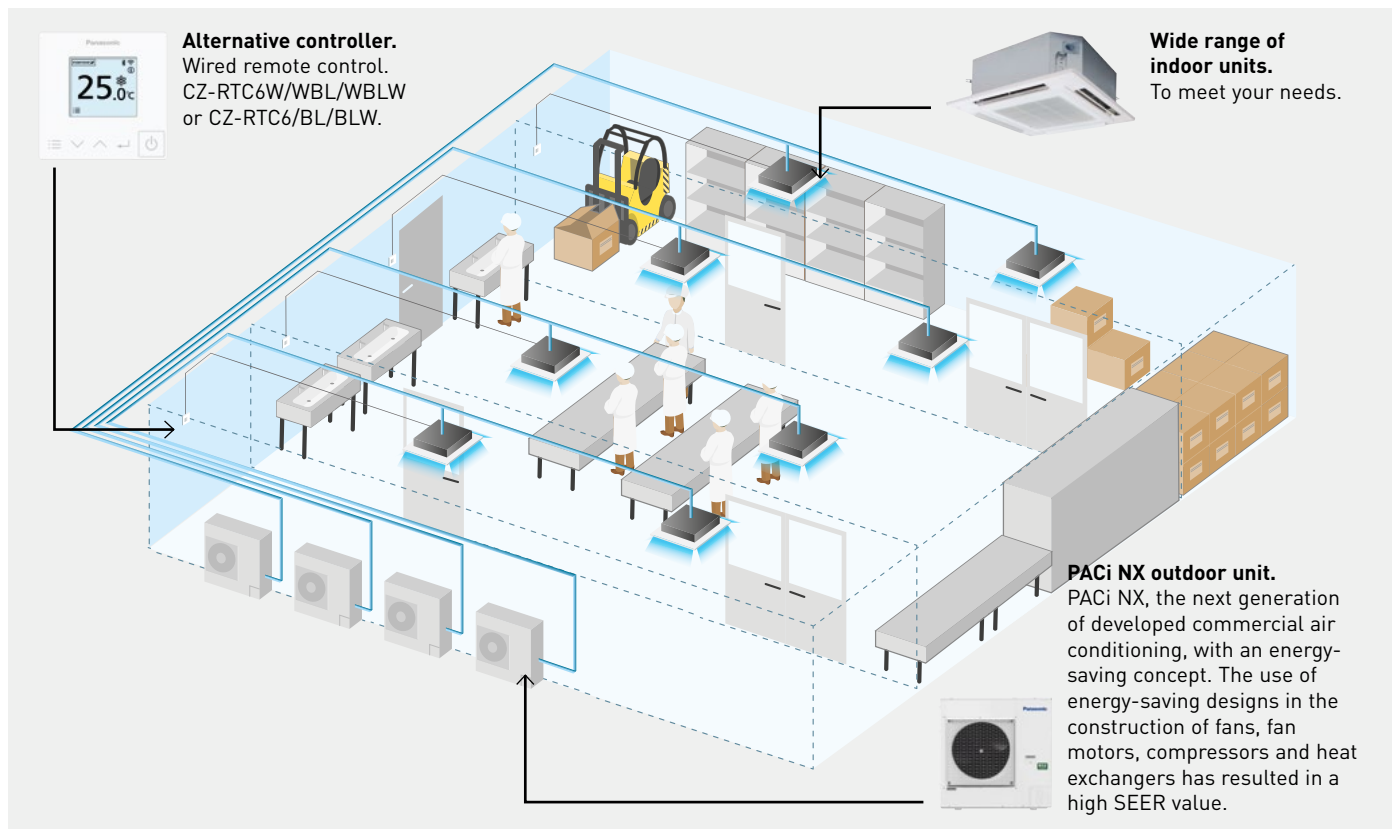

- Flexibility with different type of indoors
- Benefits of hydroxyl radicals
- Out of the box solution from Panasonic. Outdoor, indoor, controller comes as package
- Provides wide scale of control options (individual, central, cloud)
- Redundancy for 2 systems with CONEX controller range and up to 4 indoor unit groups with PAW-PACR4 optional redundancy controller



Wine cellars and special high temperature rooms

One of the main features of the PACi NX series is the possibility of adjusting the product for special applications, not just for regular cooling applications. The purpose of this product information is to explain in detail these special applications that need a cooling operation to maintain the room temperature at +8 ~ +24 °C WB (or +10 ~ +30 °C DB). In order to do this in terms of enthalpy, the indoor unit needs to be oversized and certain parameters need to be adjustable.

Temperature range for wine cellar		
	Indoor	Outdoor
Cooling operation	+8 ~ +24 °C WB	-5 [-15] ~ 43 °C DB

Temperature range for wine cellar.
In cooling. Outdoor air intake temperature °C DB.

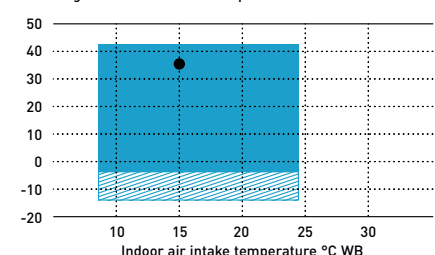

 Only allowed after installation of wind and snow vents.

 Area where cooling capacity is established for this purpose.

Bringing nature's balance indoors



nanoe™ X, technology with the benefits of hydroxyl radicals.

Abundant in nature, hydroxyl radicals (also known as OH radicals) have the capacity to inhibit pollutants, viruses, and bacteria to clean and deodorise. nanoe™ X technology can bring these incredible benefits indoors so that hard surfaces, soft furnishings, and the indoor environment can be a cleaner and more pleasant place to be.



Panasonic's nanoe™ X technology takes this a step further and brings nature's detergent – hydroxyl radicals – indoors to help create an ideal environment

Thanks to the nanoe™ X properties, several types of pollutants can be inhibited such as certain types of bacteria, viruses, mould, allergens, pollen and certain hazardous substances.

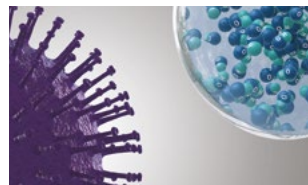

1 | nanoe™ X reliably reaches pollutants.

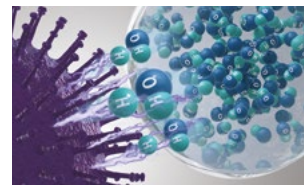

2 | Hydroxyl radicals denature pollutants' proteins.

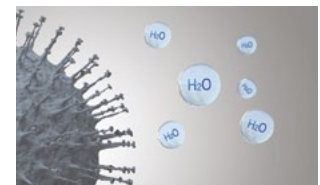

3 | Pollutants activity is inhibited.

What is unique about nanoe™ X?

Effective on fabrics and surfaces.

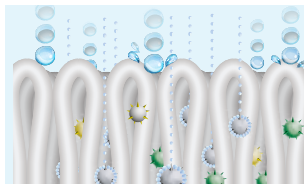

1 | At one billionth of a metre, nanoe™ X is much smaller than steam and can deeply penetrate cloth fabrics to deodorise.

Longer lifespan.



2 | Contained in tiny water particles, nanoe™ X has a long lifespan, which is about 600 seconds, to spread easily around the room.

Huge quantity.



3 | nanoe™ X Generator Mark 2 produces 9,6 trillion hydroxyl radicals per second. Greater amounts of hydroxyl radicals contained in nanoe™ X lead to higher performance on inhibition of pollutants.

Maintenance-free.

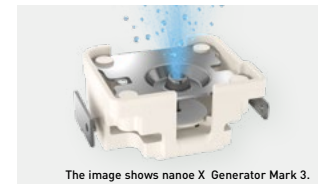

The image shows nanoe™ X Generator Mark 3.

4 | No service and maintenance required. nanoe™ X is a filter free solution that does not require maintenance, as its atomisation electrode is enveloped with water during its generation process and it is made with Titanium.

7 effects of nanoe™ X – Panasonic unique technology

Deodorises

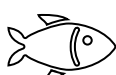

Odours

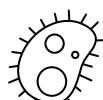

Bacteria and viruses



Mould



Allergens



Pollen



Hazardous substances



Skin and hair

Capacity to inhibit 5 types of pollutants

Moisturises

* Refer to <https://aircon.panasonic.eu> for more details and validation data.

nanoe™ X, internationally-validated technology in testing facilities.

The effectiveness of nanoe™ X technology has been tested by 3rd party laboratories in Germany, France, Denmark, Japan and China.

The nanoe™ X performance varies depending on the room size, environment and usage and it may take several hours to reach the full effect. nanoe™ X is not medical device, local regulations on building design and sanitary recommendations must be followed. Test results conducted under controlled laboratory conditions. Performance of nanoe™ X might differ in real life environment.

	Tested contents	Generator	Result	Capacity	Time	Testing organisation	Report No.	
Airborne	Virus	Influenza (H1N1)	Mark 2	98,3% inhibited	30 m³	1,5 h	China Electronic Product Reliability and Environmental Testing Research Institute	J2003WT8888-00889
		Bacteriophage ΦX174	Mark 1	99,7% inhibited	Approx. 25 m³	6 h	Kitasato Research Center for Environmental Science	24_0300_1
	Bacteria	Staphylococcus aureus	Mark 1	99,9% inhibited	Approx. 25 m³	4 h	Kitasato Research Center for Environmental Science	2016_0279
Adhering	Virus	SARS-CoV-2	Mark 1	91,4% inhibited	6,7 m³	8 h	Texcell (France)	1140-01 C3
		SARS-CoV-2	Mark 1	99,9% inhibited	45 L	2 h	Texcell (France)	1140-01 A1
		Bacteriophage ΦX174	Mark 1	99,8% inhibited	Approx. 25 m³	8 h	Japan Food Research Laboratories	13001265005-01
		Xenotropic murine leukemia virus	Mark 1	99,999% inhibited	45 L	6 h	Charles River Biopharmaceutical Services GmbH	—
		Coxsackie virus (CA16)	Mark 2	99,9%inhibited	30 m³	4 h	China Electronic Product Reliability and Environmental Testing Research Institute	J2002WT8888-00439
	Bacteria	Staphylococcus aureus	Mark 1	99,9% inhibited	20 m³	8 h	Danish Technological Institute	868988
	Pollen	Cedar	Mark 2	99%inhibited	23 m³	12 h	Panasonic Product Analysis Center	L19YA009
		Ambrosia pollen	Mark 1	99,4% inhibited	20 m³	8 h	Danish Technological Institute 868988	868988
	Odours	Cigarette smoke odour	Mark 1	Odour intensity reduced by 2,4 levels	Approx. 23 m³	0,2 h	Panasonic Product Analysis Center	4AA33-160615-N04

First nanoe™ device was developed by Panasonic in 2003

Generator: nanoe™	Generator: nanoe™ X		
2003	Mark 1 - 2016	Mark 2 - 2019	NEW Mark 3 - 2022
480 billion hydroxyl radicals/sec	4,8 trillion hydroxyl radicals/sec	9,6 trillion hydroxyl radicals/sec	48 trillion hydroxyl radicals/sec
Ion particle structure Hydroxyl radicals	10x times	20x times	100x times

nanoe™ X: improving protection 24/7



Acts to clean the work area, such as meat or fish handling in hotel kitchens, food handling in industrial processes, laboratories, wine cellars, etc. So that the indoor environment can be a cleaner and more pleasant place to be all day long and keep the processes in better bacterial conditions.

nanoe™ X works together with the cooling function when during the day but can work independently when the area is not occupied.

Give the system the strength to increase the protection of persons, air, colds stuffs and working surfaces with nanoe™ X technology and convenient control via the Panasonic Comfort Cloud App.



Cleans the air even when there is no work activity.

Leave the nanoe™ X mode ON to inhibit certain pollutants and deodorize before start the work activity again.

Improves your environment and better protects the products handled when you are or not at work.

Enjoy a cleaner comfortable space both when working indoors and simply when it comes to better protecting products in the cold room.

Panasonic Heating & Cooling Solutions is incorporating nanoe™ technology in a wide range of equipment

- 
Wall-mounted.
Built-in nanoe X Generator Mark 2.
- 
Ceiling.
Built-in nanoe X Generator Mark 2.
- 
4 Way 90x90 cassette.
Built-in nanoe X Generator Mark 1.
- 
Adaptive ducted unit.
Built-in nanoe X Generator Mark 2.

PACi NX Series Elite wall-mounted - PK3 · R32

For light refrigeration applications.



				High temperature							
Kit				36	50	60	71	100	125	140	
Indoor unit - 1				S-6010PK3E	S-6010PK3E	S-6010PK3E	S-6010PK3Ex2	S-6010PK3E	S-6010PK3E	S-6010PK3E	
Indoor unit - 2								S-6010PK3E	S-6010PK3E	S-6010PK3E	
Outdoor unit				U-36PZH3E5	U-50PZH3E5	U-60PZH3E5	U-71PZH4E5/8	U-100PZH4E5/8	U-125PZH4E5/8	U-140PZH4E5/8	
Outdoor 35 °C (DB)	Indoor 15 °C (WB)	Cooling capacity	kW	3,50	4,90	5,80	6,90	8,80	11,60	13,00	
		EER		4,55	3,83	3,56	3,17	2,97	3,06	3,34	
		Input power	kW	0,77	1,28	1,63	2,18	2,96	3,79	3,89	
	Indoor 12 °C (WB)	Cooling capacity	kW	3,19	4,46	5,28	6,28	8,01	10,56	11,83	
		EER		4,22	3,55	3,30	2,94	2,76	2,84	3,10	
		Input power	kW	0,75	1,25	1,60	2,14	2,90	3,71	3,81	
	Indoor 8 °C (WB)	Cooling capacity	kW	2,10	2,94	3,27	4,14	5,28	6,96	7,80	
		EER		3,50	2,94	2,14	2,44	2,28	2,35	2,57	
		Input power	kW	0,60	1,00	1,52	1,70	2,31	2,96	3,03	
	Outdoor 30 °C (DB)	Indoor 15 °C (WB)	Cooling capacity	kW	3,75	5,24	5,92	7,04	9,42	12,41	13,91
			EER		5,29	4,45	3,86	3,44	3,45	3,56	3,88
			Input power	kW	0,71	1,18	1,53	2,05	2,72	3,49	3,58
Indoor 12 °C (WB)		Cooling capacity	kW	3,43	4,80	5,39	6,42	8,62	11,37	12,74	
		EER		4,95	4,17	3,60	3,20	3,23	3,33	3,64	
		Input power	kW	0,69	1,15	1,50	2,01	2,66	3,41	3,50	
Indoor 8 °C (WB)		Cooling capacity	kW	2,10	2,94	3,48	4,14	5,28	6,96	7,80	
		EER		3,90	3,28	2,97	2,64	2,55	2,62	2,86	
		Input power	kW	0,54	0,90	1,17	1,57	2,16	2,65	2,72	
Indoor unit		Dimension (HxWxD)	mm	302 x 1120 x 236	302 x 1120 x 236	302 x 1120 x 236	302 x 1120 x 236	302 x 1120 x 236	302 x 1120 x 236	302 x 1120 x 236	302 x 1120 x 236
		Net weight	kg	14	14	14	14	14	14	14	14
		nanoe X Generator		Mark 2	Mark 2	Mark 2	Mark 2	Mark 2	Mark 2	Mark 2	Mark 2
Outdoor unit	Dimension (HxWxD)	mm	695 x 875 x 320	695 x 875 x 320	695 x 875 x 320	996 x 980 x 370	996 x 980 x 370	996 x 980 x 370	996 x 980 x 370	996 x 980 x 370	
	Net weight	kg	42	42	43	66	84	86	86		

Accessories

CZ-RTC6W ¹⁾	CONEX wired remote controller (non-wireless), white
CZ-RTC6WBL ¹⁾	CONEX wired remote controller with Bluetooth®, white
CZ-RTC6WBLW ¹⁾	CONEX wired remote controller with Wi-Fi and Bluetooth®, white
CZ-RTC6	CONEX wired remote controller (non-wireless), black
CZ-RTC6BL	CONEX wired remote controller with Bluetooth®, black
CZ-RTC6BLW	CONEX wired remote controller with Wi-Fi and Bluetooth®, black
CZ-RTC5B	Wired remote controller with Econavi function and datanavi
CZ-RWS3	Infrared remote controller

1) Available in Autumn 2023.

Accessories

PAW-PACR4	Interface to run up to 4 indoor unit groups on backup and alternative run
PAW-WTRAY	Tray for condenser water compatible with outdoor elevation platform
PAW-GRDBSE20	Outdoor base ground support for noise and vibration absorption
PAW-GRDSTD40	Outdoor elevation platform 400 x 900 x 400 mm
CZ-CENSC1	Econavi energy saving sensor

Technical focus

- Modern design with flat face and compact size
- DC fan for better efficiency and control
- Six directional piping outlet
- nanoe™ X (Generator Mark 2= 9,6 trillion hydroxyl radicals/sec) as standard for better indoor air quality
- Wired remote control CZ-RTC6WBL and CZ-RTC6BL allows easy system setting via Bluetooth®
- Easy connection and control of external fan or ERV using the connector PAW-FDC on the indoor unit PCB. The external device can be controlled by the remote control of the Panasonic indoor unit

Closed discharge port

When the unit is turned OFF, the flap closes completely to prevent dust getting into the unit and to keep the equipment clean.

Quiet operation

These units are among the quietest in the industry, making them ideal for all types of installations.

Piping outlet in six directions

Piping outlet is possible in six directions of; right, right rear, right bottom, left, left rear and left bottom, making the installation work more flexible.

PACi NX Series Elite 4 way 90x90 cassette - PU3 · R32

For light refrigeration applications.



Kit			High temperature									
			36	50	60	71	100	125	140	200	250	
Indoor unit - 1			S-6071PU3E	S-6071PU3E	S-6071PU3E	S-1014PU3E	S-1014PU3E	S-1014PU3E	S-1014PU3E	S-1014PU3E	S-1014PU3E	
Indoor unit - 2			—	—	—	—	—	—	S-1014PU3E	S-1014PU3E	S-1014PU3E	
Outdoor unit			U-36PZH3E5	U-50PZH3E5	U-60PZH3E5	U-71PZH4E5/8	U-100PZH4E5/8	U-125PZH4E5/8	U-140PZH4E5/8	U-200PZH2E8	U-250PZH2E8	
Outdoor 35 °C (DB)	Indoor 15 °C (WB)	Cooling capacity	kW	3,50	4,90	5,80	6,90	8,80	11,60	13,00	18,50	23,20
		EER		5,12	4,05	3,81	3,67	4,09	3,47	3,82	3,38	2,97
		Input power	kW	0,68	1,21	1,52	1,88	2,15	3,34	3,40	5,48	7,82
	Indoor 12 °C (WB)	Cooling capacity	kW	3,19	4,46	5,28	6,28	8,01	10,56	11,83	16,84	21,11
		EER		4,78	3,76	3,54	3,41	3,80	3,22	3,55	3,13	2,75
		Input power	kW	0,67	1,19	1,49	1,84	2,11	3,27	3,33	5,37	7,66
	Indoor 8 °C (WB)	Cooling capacity	kW	2,10	2,94	3,48	4,14	5,28	6,96	7,80	11,10	13,92
		EER		3,96	3,12	2,94	2,82	3,15	2,67	2,94	2,60	2,28
		Input power	kW	0,53	0,94	1,19	1,47	1,68	2,61	2,65	4,27	6,10
Outdoor 30 °C (DB)	Indoor 15 °C (WB)	Cooling capacity	kW	3,75	5,24	5,92	7,04	9,42	12,41	13,91	20,17	25,29
		EER		5,99	4,71	4,14	3,98	4,76	4,04	4,45	4,00	3,51
		Input power	kW	0,63	1,11	1,43	1,77	1,98	3,07	3,13	5,04	7,19
	Indoor 12 °C (WB)	Cooling capacity	kW	3,43	4,80	5,39	6,42	8,62	12,41	12,74	18,50	23,20
		EER		5,60	4,41	3,86	3,71	4,46	4,04	4,16	3,75	3,30
		Input power	kW	0,61	1,09	1,40	1,73	1,94	3,07	3,06	4,93	7,04
	Indoor 8 °C (WB)	Cooling capacity	kW	2,10	2,94	3,48	4,14	5,28	6,96	7,80	11,10	13,92
		EER		4,41	3,47	3,18	3,06	3,51	2,98	3,28	2,89	2,54
		Input power	kW	0,48	0,85	1,09	1,35	1,51	2,34	2,38	3,84	5,47
Indoor unit	Dimension (HxWxD)	mm	256x840x840	256x840x840	256x840x840	319x840x840	319x840x840	319x840x840	319x840x840	319x840x840	319x840x840	
	Net weight	kg	19	19	20	25	25	25	25	25	25	
	nanoe X Generator		Mark 1	Mark 1	Mark 1	Mark 1	Mark 1	Mark 1	Mark 1	Mark 1	Mark 1	
Outdoor unit	Dimension (HxWxD)	mm	695x875x320	695x875x320	695x875x320	996x980x370	996x980x370	996x980x370	996x980x370	1500x980x370	1500x980x370	
	Net weight	kg	42	42	43	66	84	86	86	117	128	

Accessories

CZ-RTC6W ¹⁾	CONEX wired remote controller (non-wireless), white
CZ-RTC6WBL ¹⁾	CONEX wired remote controller with Bluetooth®, white
CZ-RTC6WBLW ¹⁾	CONEX wired remote controller with Wi-Fi and Bluetooth®, white
CZ-RTC6	CONEX wired remote controller (non-wireless), black
CZ-RTC6BL	CONEX wired remote controller with Bluetooth®, black
CZ-RTC6BLW	CONEX wired remote controller with Wi-Fi and Bluetooth®, black
CZ-RTC5B	Wired remote controller with Econavi function and datanavi

Accessories

CZ-RWS3 + CZ-RWRU3W	Infrared remote controller and receiver
CZ-KPU3AW	Econavi exclusive panel
PAW-WTRAY	Tray for condenser water compatible with outdoor elevation platform
PAW-GRDBSE20	Outdoor base ground support for noise and vibration absorption
PAW-GRDSTD40	Outdoor elevation platform 400x900x400 mm
CZ-FDU3+CZ-ATU2	Fresh air-intake kit

1) Available in Autumn 2023.

Technical focus

- High performance turbo fan
- Econavi: An optional intelligent sensor to reduce waste of energy
- nanoe™ X (Generator Mark 1= 4,8 trillion hydroxyl radicals/sec) as standard for better indoor air quality, indoor unit internal cleaning with nanoe™ X plus dry operation
- Lower noise in low fan operation
- Light weight, easy piping and integrated drain pump for quick installation
- Wired remote control CZ-RTC6WBL and CZ-RTC6BL allows easy system setting via Bluetooth®
- High volume fresh air input with optional air-intake plenum and chamber (CZ-FDU3+CZ-ATU2)

PACi NX Series Elite ceiling - PT3 · R32

For light refrigeration applications.



Kit		High temperature											
		36	50	60	71	100	125	140	200	250			
Indoor unit - 1		S-6071PT3E	S-6071PT3E	S-1014PT3E	S-1014PT3E	S-1014PT3E	S-1014PT3E	S-1014PT3E	S-1014PT3E	S-1014PT3E			
Indoor unit - 2		—	—	—	—	—	—	S-1014PT3E	S-1014PT3E	S-1014PT3E			
Outdoor unit		U-36PZH3E5	U-50PZH3E5	U-60PZH3E5	U-71PZH4E5/8	U-100PZH4E5/8	U-125PZH4E5/8	U-140PZH3E5/8	U-200PZH2E8	U-250PZH2E8			
Outdoor 35 °C (DB)	Indoor 15 °C (WB)	Cooling capacity	kW	3,50	4,90	5,80	6,60	8,80	11,20	13,00	18,50	23,20	
		EER		4,67	3,71	3,63	3,53	3,76	3,15	3,40	3,32	2,92	
		Input power	kW	0,75	1,32	1,60	1,87	2,34	3,56	3,82	5,57	7,94	
	Indoor 12 °C (WB)	Cooling capacity	kW	3,19	4,46	5,28	6,01	8,01	10,19	11,83	16,84	21,11	
		EER		4,33	3,45	3,37	3,28	3,49	2,92	3,16	3,08	2,71	
		Input power	kW	0,74	1,29	1,57	1,83	2,29	3,49	3,74	5,46	7,78	
	Indoor 8 °C (WB)	Cooling capacity	kW	2,10	2,94	3,48	3,96	5,28	6,72	7,80	11,10	13,92	
		EER		3,59	2,86	2,79	2,71	2,89	2,42	2,62	2,55	2,25	
		Input power	kW	0,59	1,03	1,25	1,46	1,83	2,78	2,98	4,34	6,19	
	Outdoor 30 °C (DB)	Indoor 15 °C (WB)	Cooling capacity	kW	3,75	5,24	5,92	6,73	9,42	11,98	13,91	20,17	25,29
			EER		5,43	4,32	3,93	3,83	4,37	3,66	3,96	3,94	3,46
			Input power	kW	0,69	1,21	1,50	1,76	2,15	3,28	3,51	5,12	7,30
Indoor 12 °C (WB)		Cooling capacity	kW	3,43	4,80	5,39	6,14	8,62	10,98	12,74	18,50	23,20	
		EER		5,08	4,04	3,66	3,57	4,09	3,43	3,71	3,69	3,25	
		Input power	kW	0,68	1,19	1,47	1,72	2,11	3,20	3,44	5,01	7,15	
Indoor 8 °C (WB)		Cooling capacity	kW	2,10	2,94	3,48	3,96	5,28	6,72	7,80	11,10	13,92	
		EER		4,00	3,18	3,02	2,94	3,22	2,70	2,92	2,85	2,50	
		Input power	kW	0,53	0,92	1,15	1,35	1,64	2,49	2,67	3,90	5,56	
Indoor unit		Dimension (HxWxD)	mm	235x1275x690	235x1275x690	235x1590x690	235x1590x690	235x1590x690	235x1590x690	235x1590x690	235x1590x690	235x1590x690	
		Net weight	kg	34	34	40	40	40	40	40	40	40	
		nanoe X Generator		Mark 2	Mark 2	Mark 2	Mark 2	Mark 2	Mark 2	Mark 2	Mark 2	Mark 2	
Outdoor unit	Dimension (HxWxD)	mm	695x875x320	695x875x320	695x875x320	996x980x370	996x980x370	996x980x370	996x980x370	1500x980x370	1500x980x370		
	Net weight	kg	42	42	43	66	84	86	86	117	128		

Accessories

CZ-RTC6W ¹⁾	CONEX wired remote controller (non-wireless), white
CZ-RTC6WBL ¹⁾	CONEX wired remote controller with Bluetooth®, white
CZ-RTC6WBLW ¹⁾	CONEX wired remote controller with Wi-Fi and Bluetooth®, white
CZ-RTC6	CONEX wired remote controller (non-wireless), black
CZ-RTC6BL	CONEX wired remote controller with Bluetooth®, black
CZ-RTC6BLW	CONEX wired remote controller with Wi-Fi and Bluetooth®, black
CZ-RTC5B	Wired remote controller with Econavi function and datanavi

1) Available in Autumn 2023.

Accessories

CZ-RWS3 + CZ-RWRT3	Infrared remote controller and receiver
PAW-WTRAY	Tray for condenser water compatible with outdoor elevation platform
PAW-GRDBSE20	Outdoor base ground support for noise and vibration absorption
PAW-GRDSTD40	Outdoor elevation platform 400x900x400 mm
CZ-CENSC1	Econavi energy saving sensor

Technical focus

- Wide air distribution for large rooms
- Horizontal air flow reaches maximum 9,5 m
- Fresh air connection available on the unit
- Slim design with 235 mm height fits narrow space
- Silent operation
- nanoe™ X (Generator Mark 2= 9,6 trillion hydroxyl radicals/sec) as standard for better indoor air quality
- Wired remote control CZ-RTC6WBL and CZ-RTC6BL allows easy system setting via Bluetooth®
- Twin, Triple and Double-twin split options
- Easy connection and control of external fan or ERV using the connector PAW-FDC on the indoor unit PCB. The external device can be controlled by the remote control of the Panasonic indoor unit

Further comfort improvement with airflow distribution

Horizontal air flow reaches maximum 9,5 m. This is ideal for wide rooms.

The wide air discharge opening expands the air flow to the left and right. The unpleasant feeling caused when the air flow directly hits the human body is prevented by the "Draft prevention position", which changes the swing width, so that the degree of comfort is increased.

PACi NX Series Elite adaptive ducted unit - PF3 · R32

For light refrigeration applications.



			High temperature									
Kit			36	50	60	71	100	125	140	200	250	
Indoor unit - 1			S-6071PF3E	S-6071PF3E	S-6071PF3E	S-1014PF3E	S-1014PF3E	S-1014PF3E	S-1014PF3E	S-1014PF3E	S-1014PF3E	
Indoor unit - 2			—	—	—	—	—	—	S-1014PF3E	S-1014PF3E	S-1014PF3E	
Outdoor unit			U-36PZH3E5	U-50PZH3E5	U-60PZH3E5	U-71PZH4E5/8	U-100PZH4E5/8	U-125PZH4E5/8	U-140PZH4E5/8	U-200PZH2E8	U-250PZH2E8	
Outdoor 35 °C (DB)	Indoor 15 °C (WB)	Cooling capacity	kW	3,50	4,90	5,80	6,60	8,80	11,20	13,00	18,50	23,20
		EER		3,98	3,20	3,52	3,37	3,79	3,21	3,59	3,50	3,08
		Input power	kW	0,88	1,53	1,65	1,96	2,32	3,49	3,62	5,29	7,54
	Indoor 12 °C (WB)	Cooling capacity	kW	3,19	4,46	5,28	6,01	8,01	10,19	11,83	16,84	21,11
		EER		3,69	2,97	3,26	3,13	3,52	2,98	3,33	3,25	2,86
		Input power	kW	0,86	1,50	1,62	1,92	2,27	3,42	3,55	5,18	7,39
	Indoor 8 °C (WB)	Cooling capacity	kW	2,10	2,94	3,48	3,96	5,28	6,72	7,80	11,10	13,92
		EER		3,06	2,46	2,70	2,59	2,92	2,47	2,76	2,69	2,37
		Input power	kW	0,69	1,19	1,29	1,53	1,81	2,72	2,82	4,13	5,88
Outdoor 30 °C (DB)	Indoor 15 °C (WB)	Cooling capacity	kW	3,75	5,24	5,92	6,73	9,42	11,98	13,91	20,17	25,29
		EER		4,63	3,72	3,81	3,65	4,41	3,73	4,18	4,14	3,65
		Input power	kW	0,81	1,41	1,55	1,84	2,13	3,21	3,33	4,87	6,94
	Indoor 12 °C (WB)	Cooling capacity	kW	3,43	4,80	5,39	6,14	8,62	10,98	12,74	18,50	23,20
		EER		4,33	3,49	3,55	3,40	4,13	3,49	3,91	3,89	3,42
		Input power	kW	0,79	1,38	1,52	1,80	2,09	3,14	3,26	4,76	6,79
	Indoor 8 °C (WB)	Cooling capacity	kW	2,10	2,94	3,48	3,96	5,28	6,72	7,80	11,10	13,92
		EER		3,41	2,75	2,93	2,81	3,25	2,75	3,08	3,00	2,64
		Input power	kW	0,62	1,07	1,19	1,41	1,62	2,44	2,53	3,70	5,28
Indoor unit	Dimension (HxWxD)	mm	250x1000x730	250x1000x730	250x1000x730	250x1400x730	250x1400x730	250x1400x730	250x1400x730	250x1400x730	250x1400x730	
	Net weight	kg	30	30	30	39	39	39	39	39	39	
	nanoe X Generator		Mark 2	Mark 2	Mark 2	Mark 2	Mark 2	Mark 2	Mark 2	Mark 2	Mark 2	
Outdoor unit	Dimension (HxWxD)	mm	695x875x320	695x875x320	695x875x320	996x980x370	996x980x370	996x980x370	996x980x370	1500x980x370	1500x980x370	
	Net weight	kg	42	42	43	66	84	86	84	117	128	

Accessories

CZ-RTC6W ¹⁾	CONEX wired remote controller (non-wireless), white
CZ-RTC6WBL ¹⁾	CONEX wired remote controller with Bluetooth®, white
CZ-RTC6WBLW ¹⁾	CONEX wired remote controller with Wi-Fi and Bluetooth®, white
CZ-RTC6	CONEX wired remote controller (non-wireless), black
CZ-RTC6BL	CONEX wired remote controller with Bluetooth®, black
CZ-RTC6BLW	CONEX wired remote controller with Wi-Fi and Bluetooth®, black
CZ-RTC5B	Wired remote controller with Econavi function and datanavi
CZ-RWS3 + CZ-RWRC3	Infrared remote controller and receiver

1) Available in Autumn 2023.

Technical focus

- 2 installation possibilities (horizontal / vertical)
- Maximum external static pressure: 150 Pa
- Selectable inlet air position (rear / bottom entry)
- Improved drain pan suitable for both horizontal / vertical installation
- Drain pump included
- nanoe™ X (Generator Mark 2= 9,6 trillion hydroxyl radicals/sec) as standard for the long duct piping case*
- Wired remote control CZ-RTC6WBL and CZ-RTC6BL allows easy system setting via Bluetooth®

* The performance of nanoe™ X air can be expected even by 10 m long duct by Panasonic internal survey.

Accessories

PAW-WTRAY	Tray for condenser water compatible with outdoor elevation platform
PAW-GRDBSE20	Outdoor base ground support for noise and vibration absorption
PAW-GRDSTD40	Outdoor elevation platform 400x900x400 mm
CZ-CENSC1	Econavi energy saving sensor
CZ-56DAF2	Air outlet plenum for S-3650PF3E
CZ-90DAF2	Air outlet plenum for S-6071PF3E
CZ-160DAF2	Air outlet plenum for S-1014PF3E

2 installation possibilities (horizontal / vertical)

Vertical installation is available. ESP 150Pa, sufficient for remotely installing units away from the rooms.



Improved drain pan design

Drain pan is shared in both cases horizontal and vertical installation. No need to modify the unit.

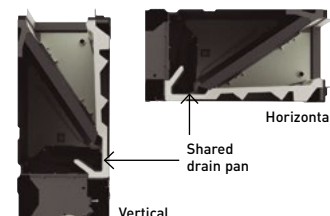

Dimensions

Aquarea

Hydraulic Split All in One / with Electrical Anode L Generation	→ 499
Hydraulic Split All in One 2 zones L Generation	→ 499
Hydraulic Split outdoor units from 5 to 9 kW L Generation	→ 500
Aquarea EcoFleX	→ 500
All in One H Generation	→ 502
All in One J Generation	→ 503
All in One Compact H and J Generations	→ 503
Hydraulic module K Generation	→ 504
Hydraulic module H and J Generations	→ 504
Hydraulic module F Generation	→ 505
Outdoor units	→ 505
Smart fan coils	→ 508
Buffer tank	→ 509
Stainless steel tanks	→ 510
Counter flow ventilation	→ 511
Heat recovery ventilation unit	→ 511
DHW Stand Alone	→ 513

Domestic

Heatcharge VZ	→ 514
Etherea	→ 515
TZ super-compact	→ 517
BZ super-compact	→ 519
UZ super-compact	→ 520
Floor console	→ 521
Low static pressure hide-away	→ 522
Outdoor units Free Multi System Z	→ 523
Outdoor units Multi Wall TZ	→ 524

Commercial

Wall-mounted Professional	→ 525
Wall-mounted	→ 527
4 way 60x60 cassette	→ 528
4 way 90x90 cassette	→ 529
Ceiling	→ 530
Adaptive ducted unit	→ 533
High static pressure hide-away	→ 534
Outdoor units	→ 535
PACi PRO-HT Tank	→ 537
PACi water heat exchanger	→ 538

VRF Systems

Mini ECOi LZ2 Series	→ 538
Mini ECOi LE2/LE1 Series	→ 539
2-Pipe ECOi EX ME2 Series	→ 540
3-Pipe ECOi EX MF3 Series	→ 541
ECO G GE3 Series	→ 542
ECO G GF3 Series	→ 543
3-Pipe Control Box Kit	→ 544
2-Pipe Hybrid EHP / GHP	→ 544
Water heat exchanger	→ 546
Y3 Type 4 way 60x60 cassette	→ 547
U2 Type 4 way 90x90 cassette	→ 548
L1 Type 2 Way Cassette	→ 549
D1 Type 1 way cassette	→ 549
F3 Type variable static pressure adaptive duct	→ 550
F2 Type variable static pressure hide-away	→ 551
M1 Type slim variable static pressure hide-away concealed duct	→ 552
E2 Type high static pressure hide-away	→ 553
Heat recovery with DX coil	→ 553
T2 Type ceiling	→ 554
K2 Type wall-mounted	→ 555
G1 Type floor console	→ 556
P1 Type floor-standing	→ 556
R1 Type concealed floor-standing	→ 557
Hydrokit for ECOi, water at 45 °C	→ 557
ECOi PRO-HT Tank	→ 558
Smart fan coils	→ 558

Ventilation

AHU connection kit for PACi NX, ECOi and ECO G	→ 559
Advanced energy recovery ventilation	→ 559
Energy recovery ventilation	→ 560
Heat recovery with DX coil	→ 561
Electric air curtain	→ 561
Air curtain with DX coil	→ 562
E2 Type high static pressure hide-away	→ 562
Ceiling mounted air-e nanoe X Generator	→ 563
Heat recovery ventilation unit	→ 563
Counter flow ventilation	→ 564

Control

VRF Smart Connectivity+	→ 565
Commercial Wi-Fi Adaptor	→ 567
Design wired remote controller	→ 567
Econavi sensor	→ 567
Remote sensor	→ 567
CONEX wired remote controller	→ 567
Intelligent controller (touch screen/web server)	→ 567
Infrared remote controller	→ 567
System controller with weekly timer	→ 568
Mini Seri-Para I/O Unit 0 -10 V	→ 568
Central ON/OFF controller	→ 568
Local adaptor for ON/OFF control	→ 568
Communication adaptor	→ 568

Chiller

ECOi-W 50 to 60 · R32	→ 569
ECOi-W 70 to 75 · R32	→ 570
ECOi-W 85 to 130 · R32	→ 571
ECOi-W 150 to 170 · R32	→ 572
ECOi-W 20 to 40 · R410A	→ 573
ECOi-W 140 to 210 · R410A	→ 574

Refrigeration

CR Series 4,0 kW	→ 576
CR Series 7,5 and 8,0 kW	→ 576
CR Series 15,0 and 16,0 kW	→ 577

Aquarea Hydraulic Split All in One / with Electrical Anode L Generation.

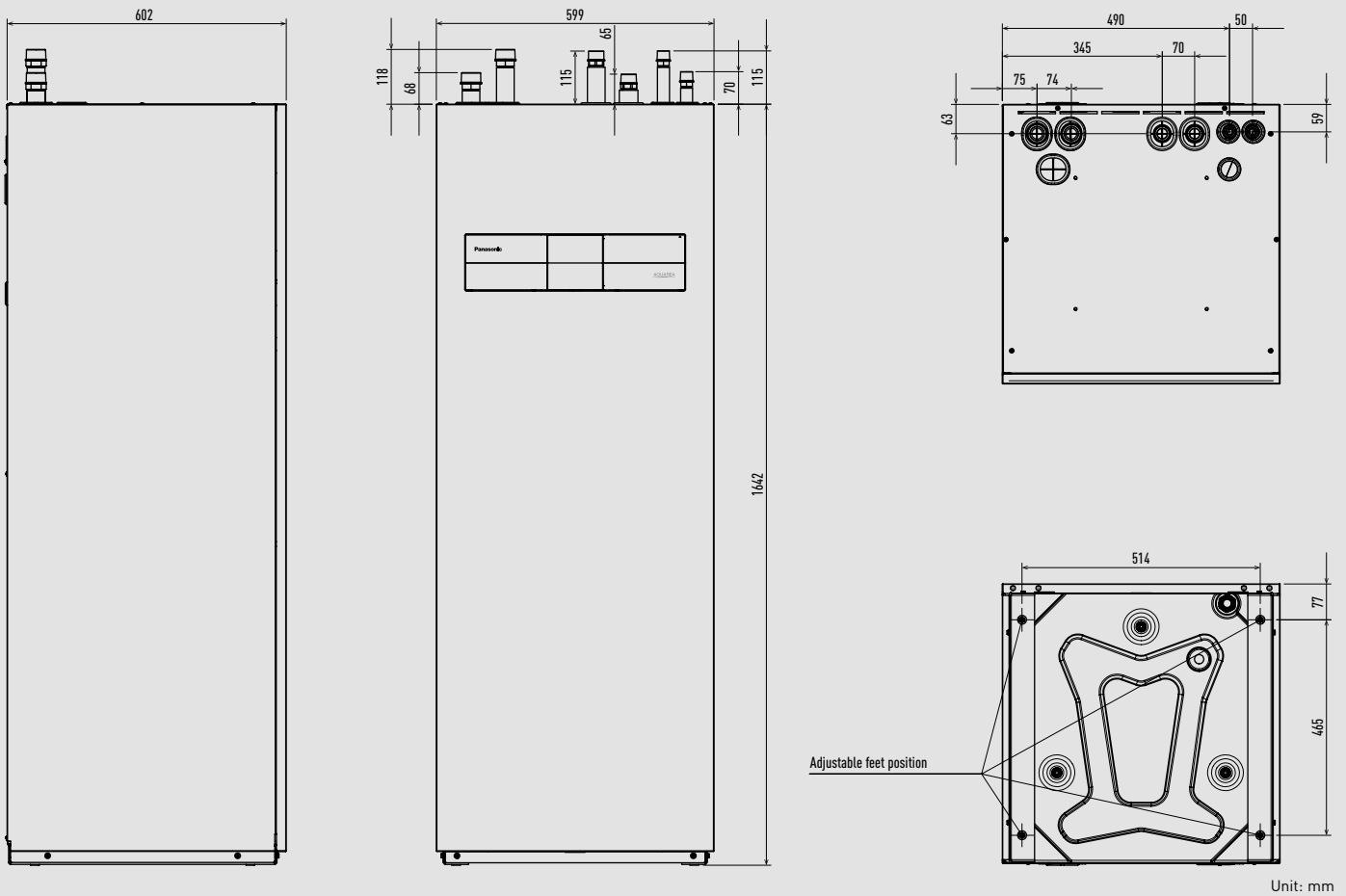

Aquarea Hydraulic Split All in One 2 zones L Generation.

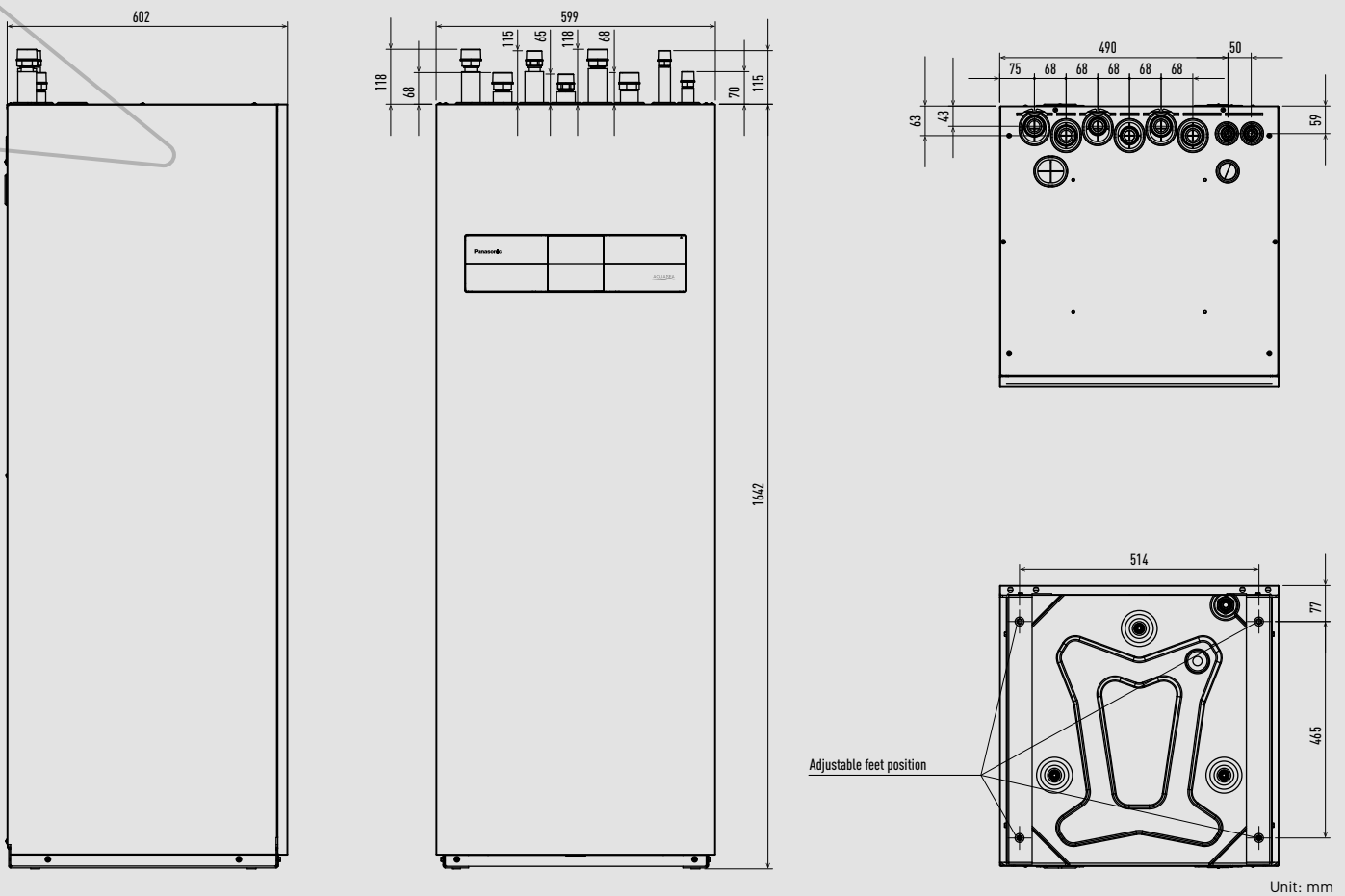

Aquarea Hydraulic Split outdoor units from 5 to 9 kW L Generation.

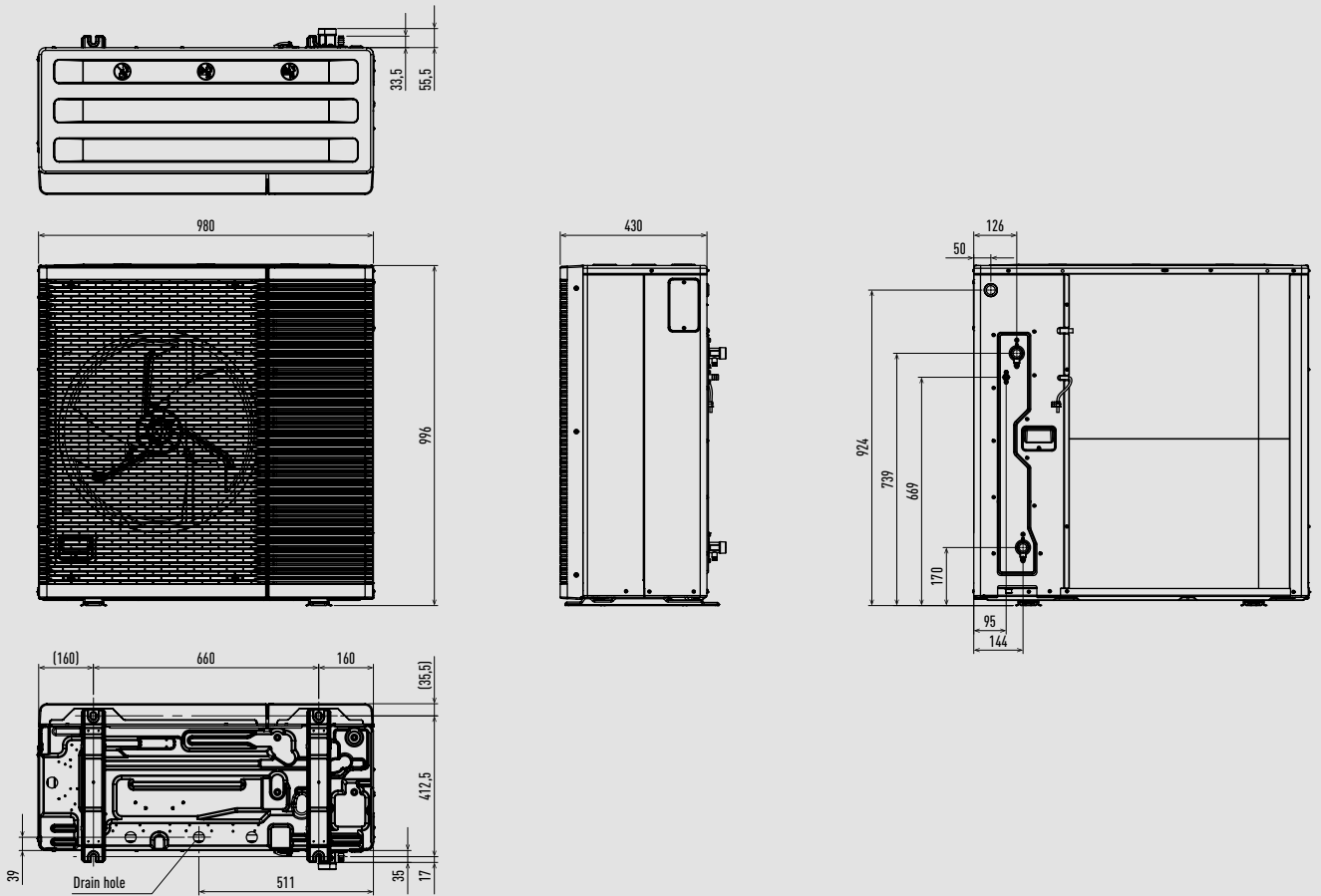

Unit: mm

Aquarea EcoFlex tank unit.

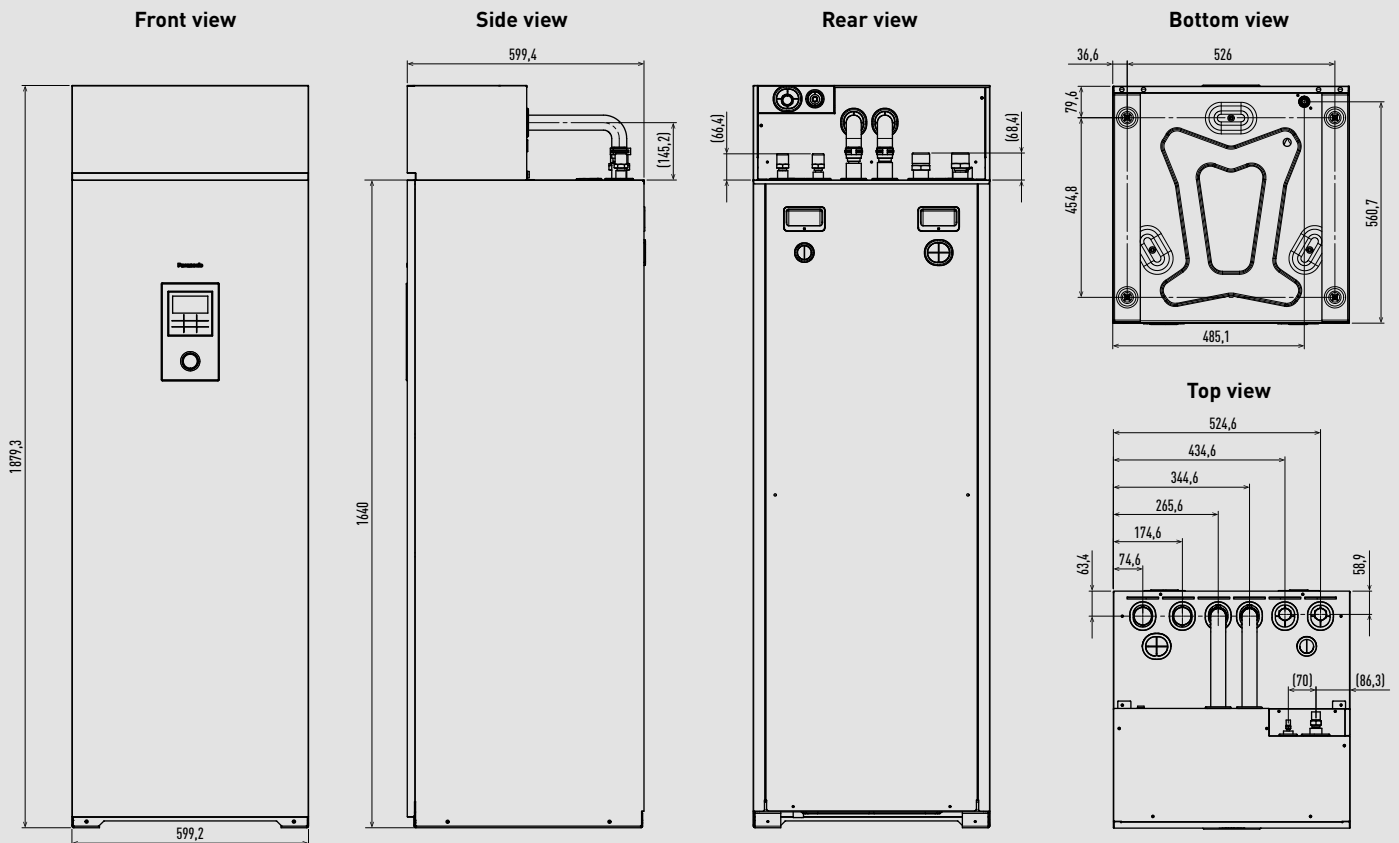

Unit: mm

Aquarea EcoFlex ducted unit.

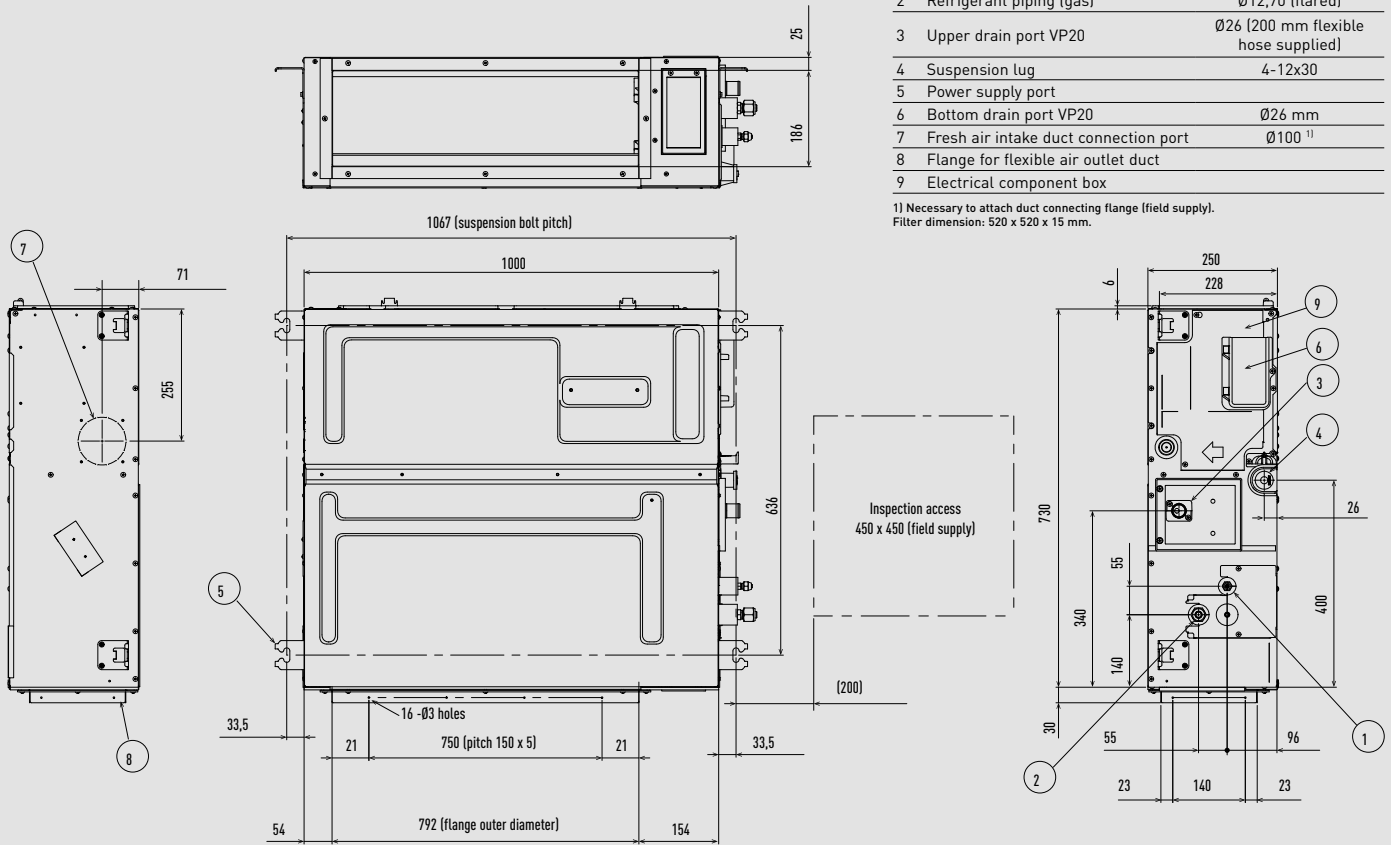

Unit: mm

Aquarea EcoFlex outdoor unit.

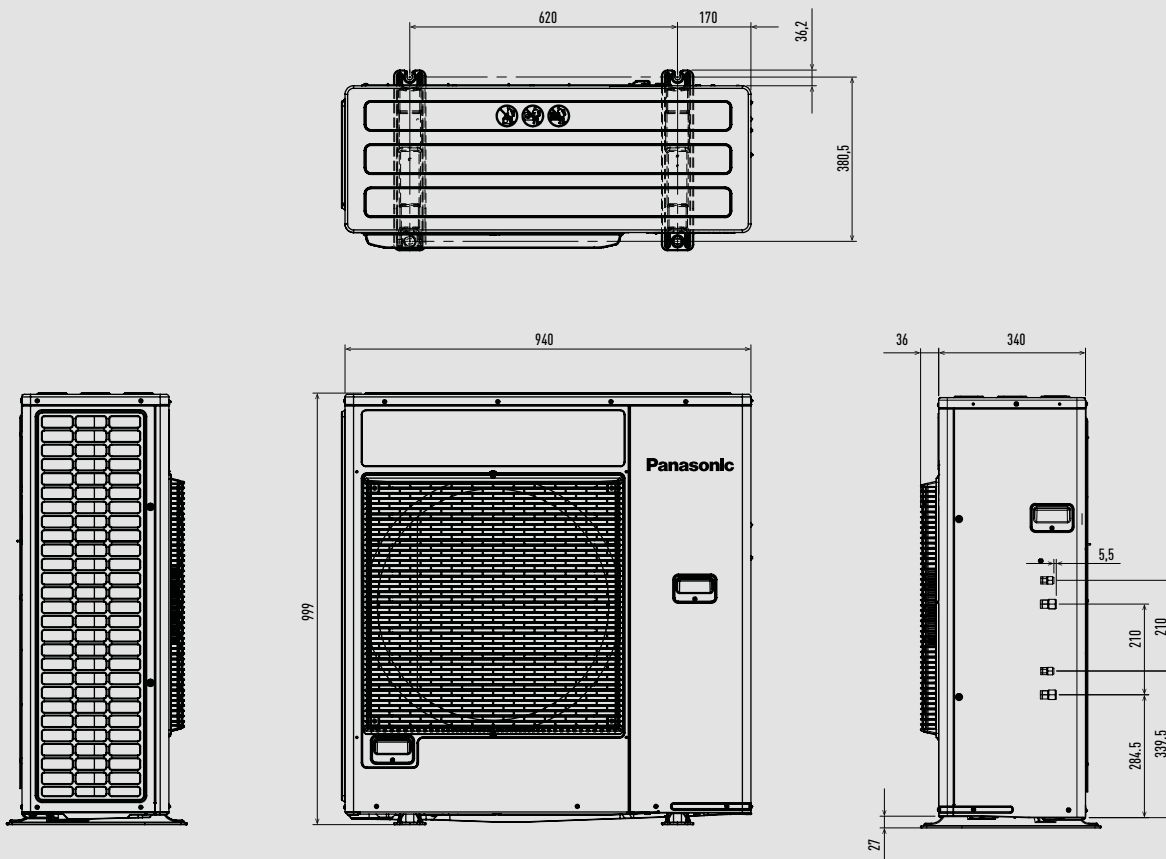

Unit: mm

Aquarea All in One K Generation.

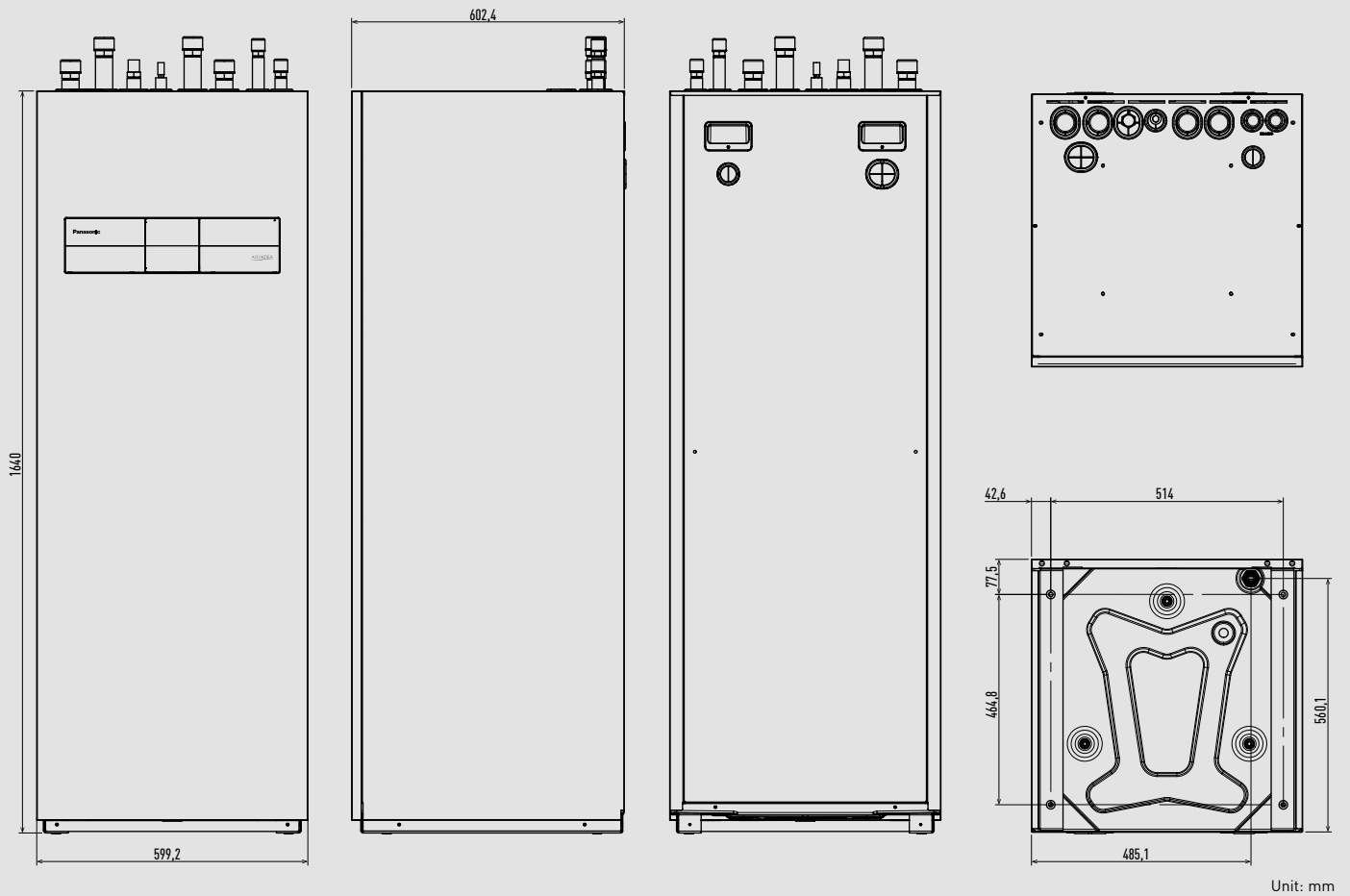

Aquarea All in One H Generation.

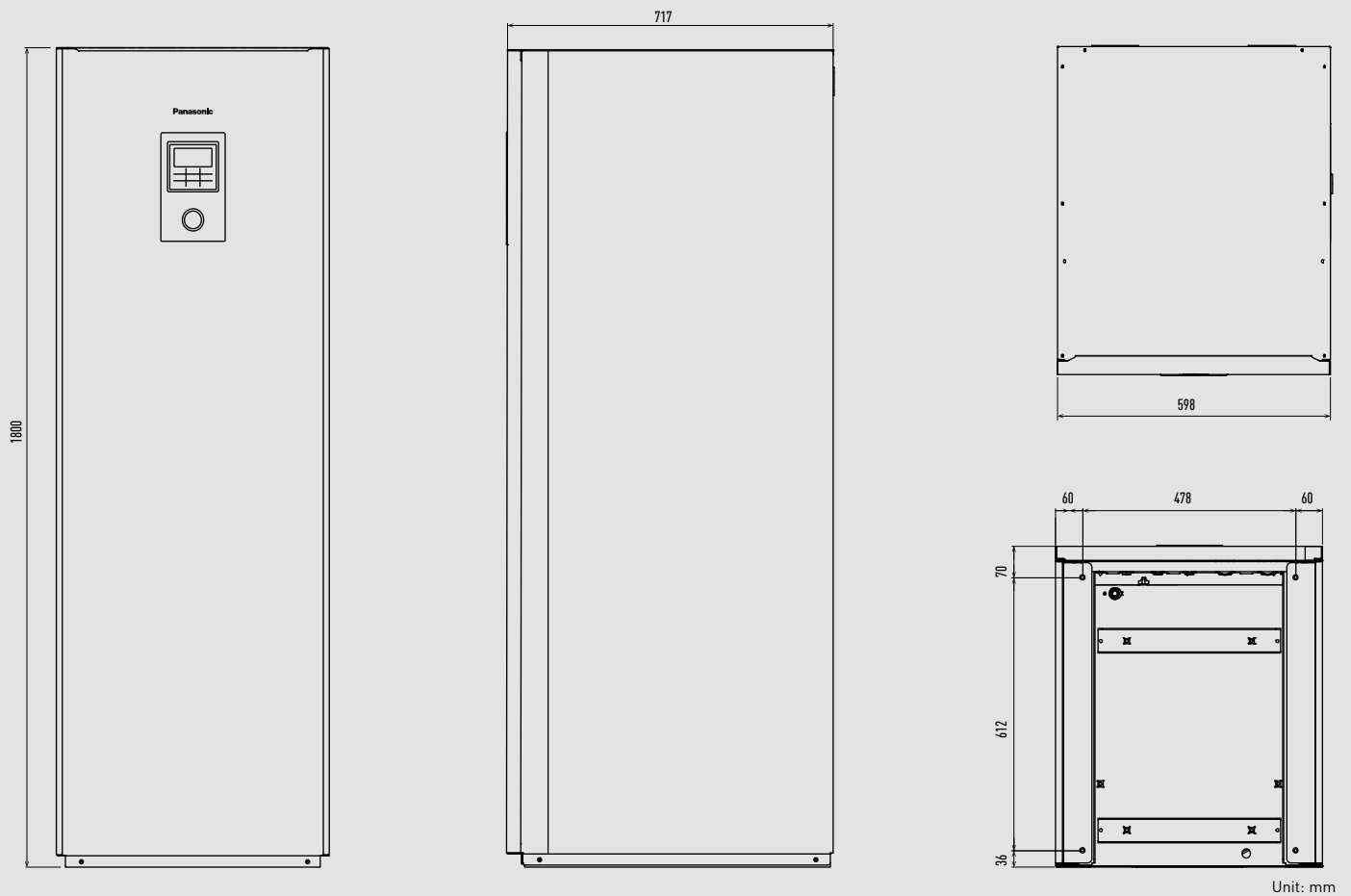

Aquarea All in One J Generation.

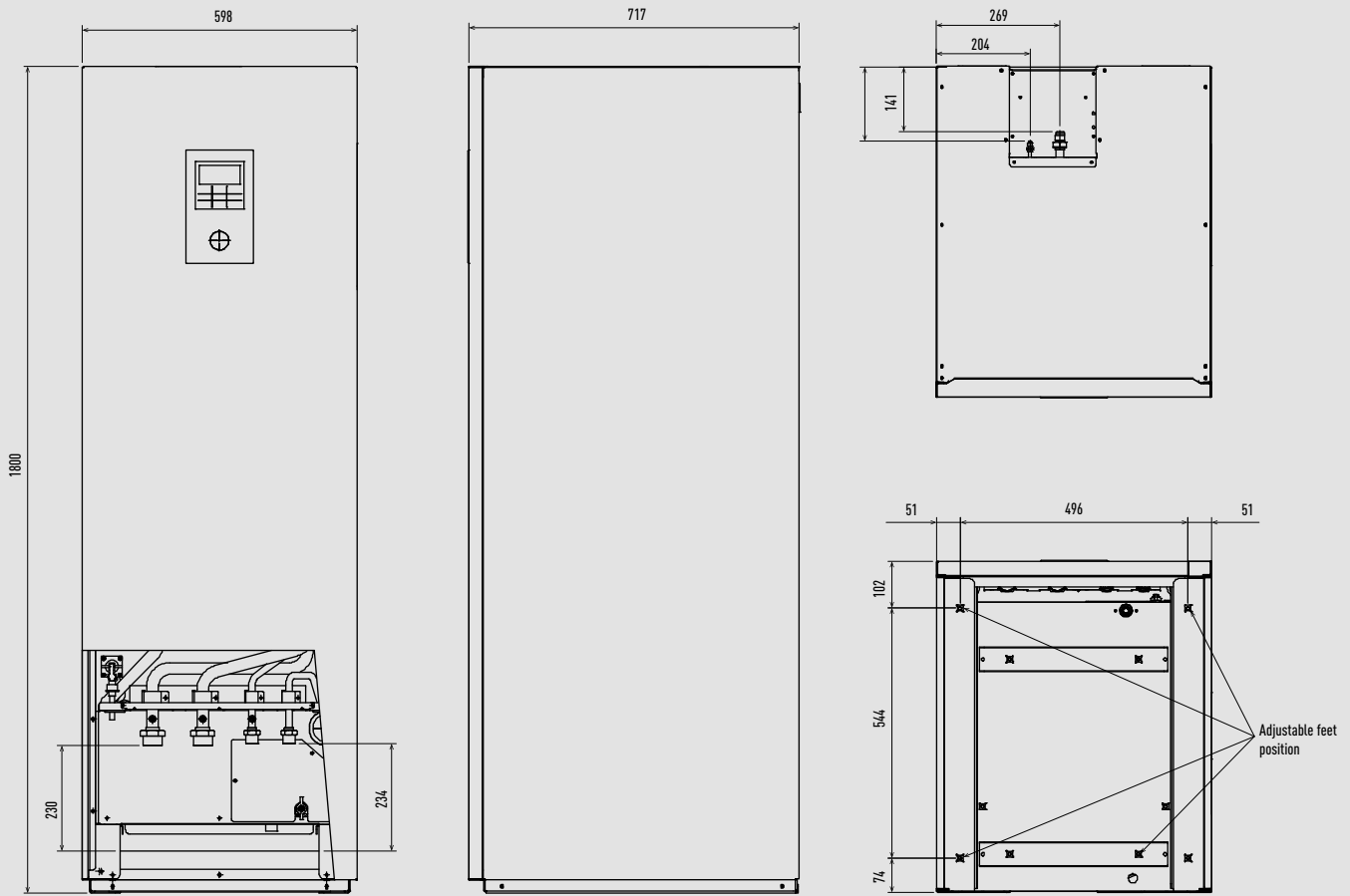

Unit: mm

Aquarea All in One Compact H and J Generations.

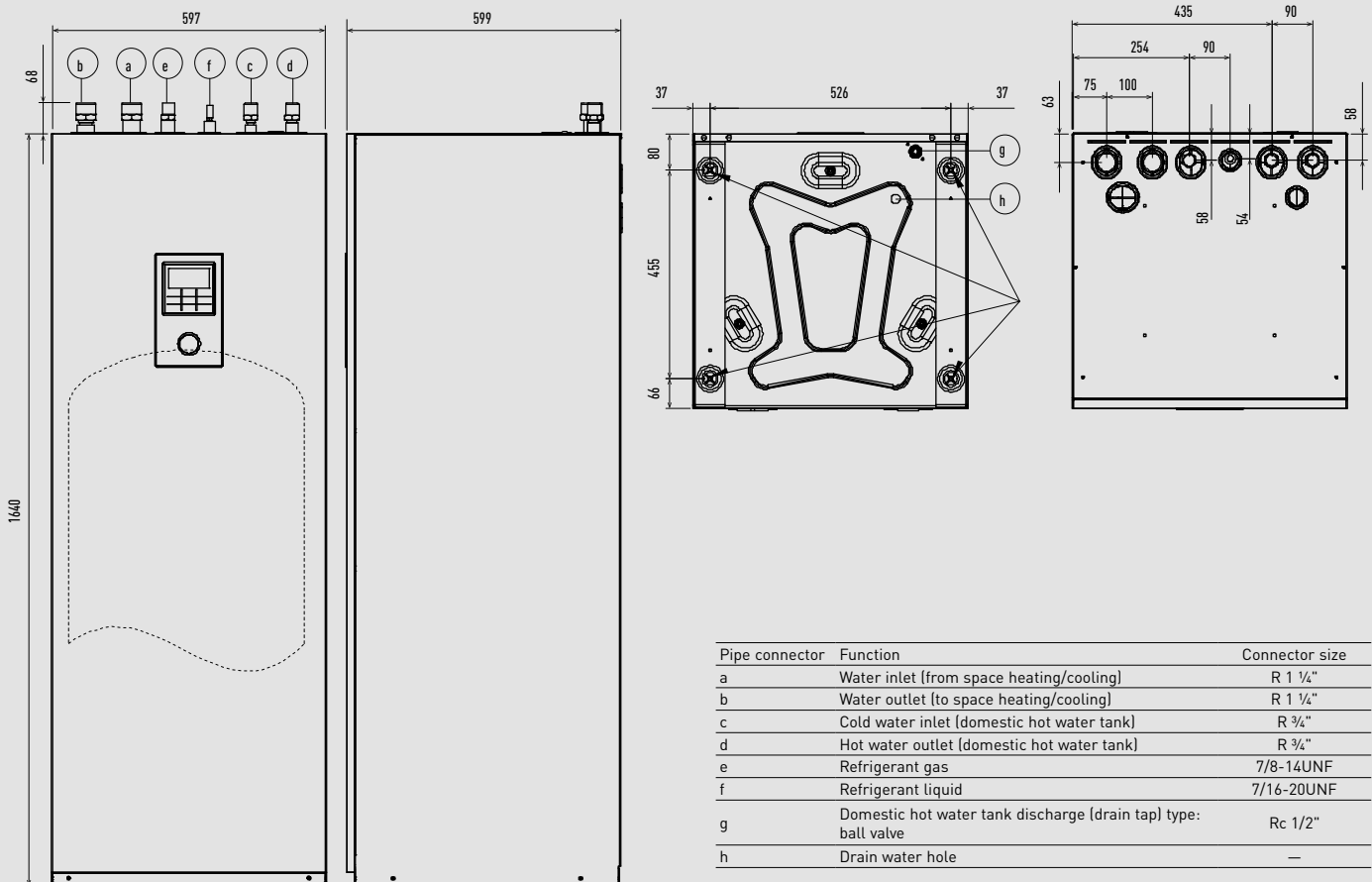

Pipe connector	Function	Connector size
a	Water inlet (from space heating/cooling)	R 1 1/4"
b	Water outlet (to space heating/cooling)	R 1 1/4"
c	Cold water inlet (domestic hot water tank)	R 3/4"
d	Hot water outlet (domestic hot water tank)	R 3/4"
e	Refrigerant gas	7/8-14UNF
f	Refrigerant liquid	7/16-20UNF
g	Domestic hot water tank discharge (drain tap) type: ball valve	Rc 1/2"
h	Drain water hole	—

Unit: mm

Aquarea hydraulic module K Generation.

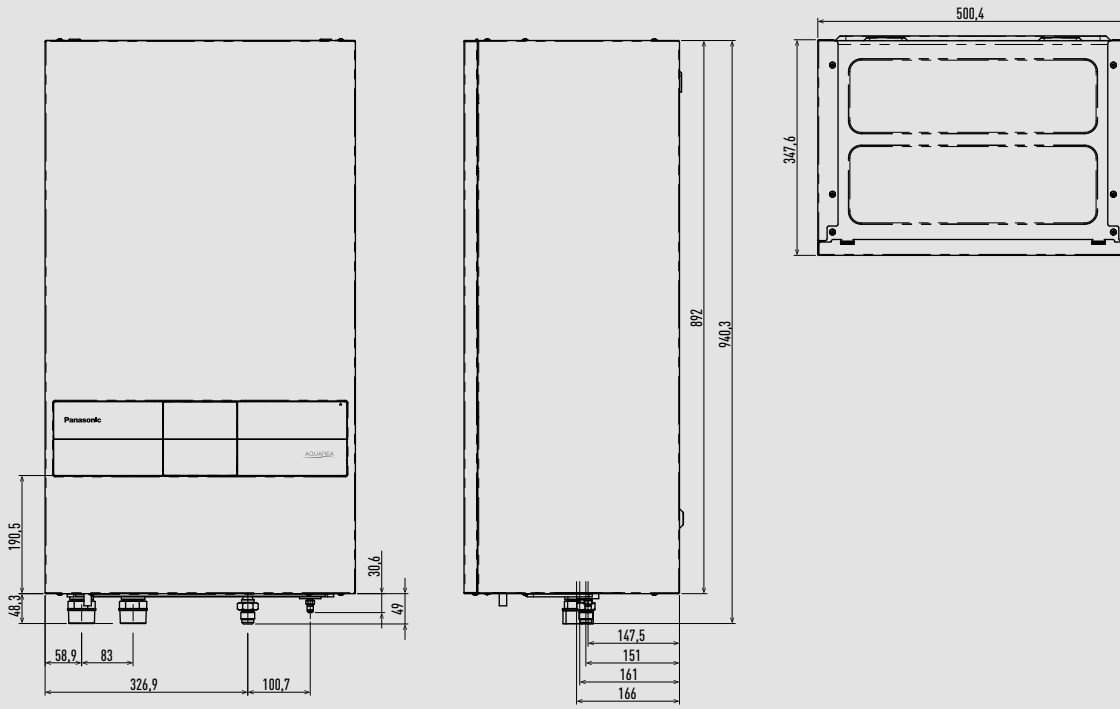

Unit: mm

Aquarea hydraulic module H and J Generations.

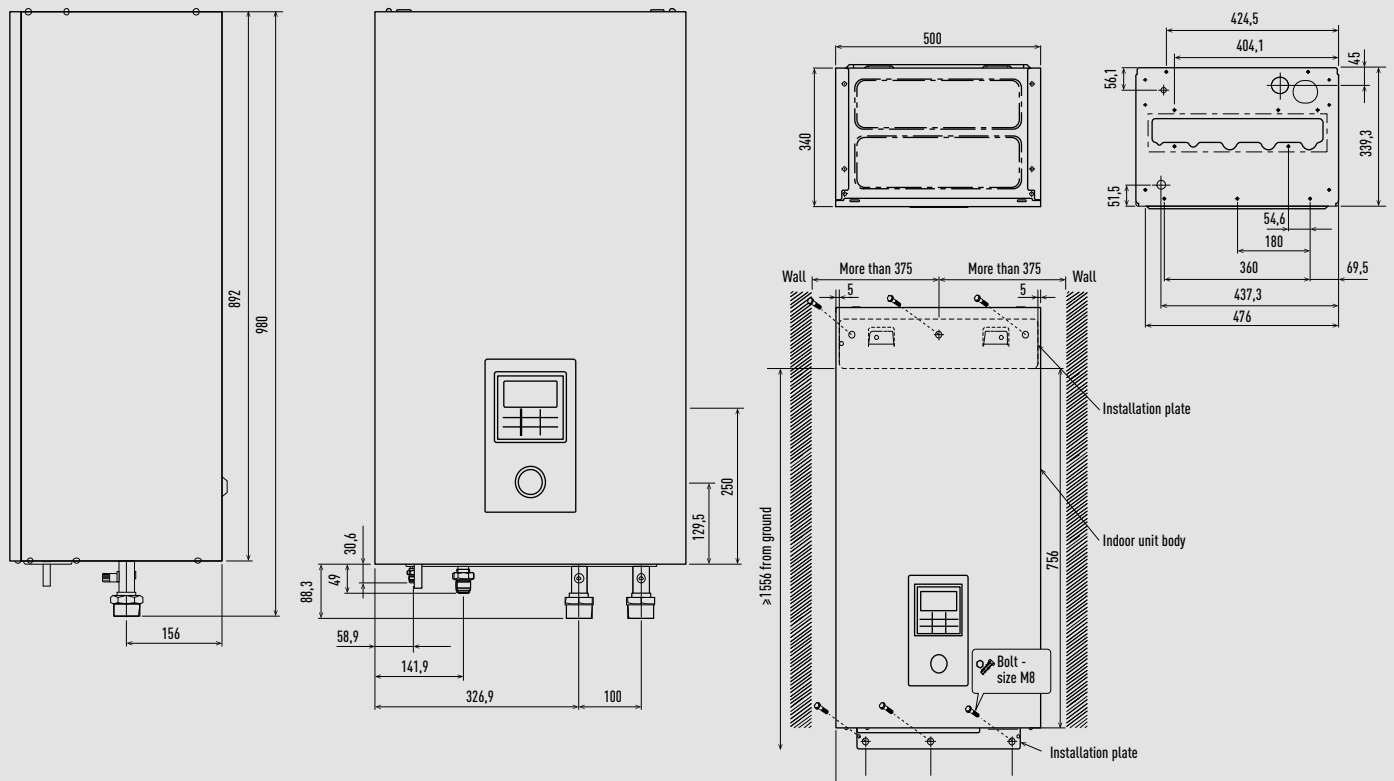

Unit: mm

Aquarea hydraulic module F Generation.

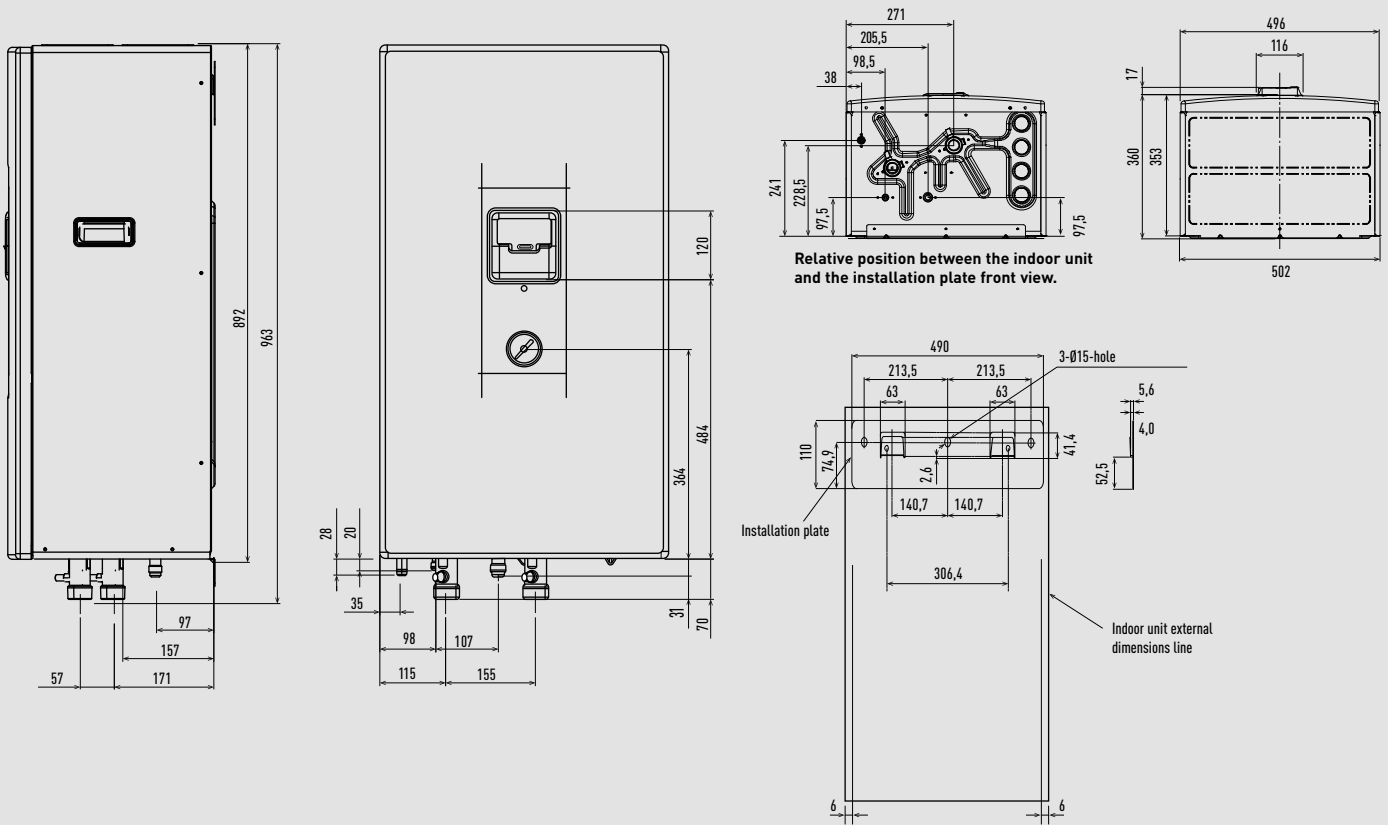

Unit: mm

Aquarea High Performance outdoor units from 5 to 9 kW K Generation.

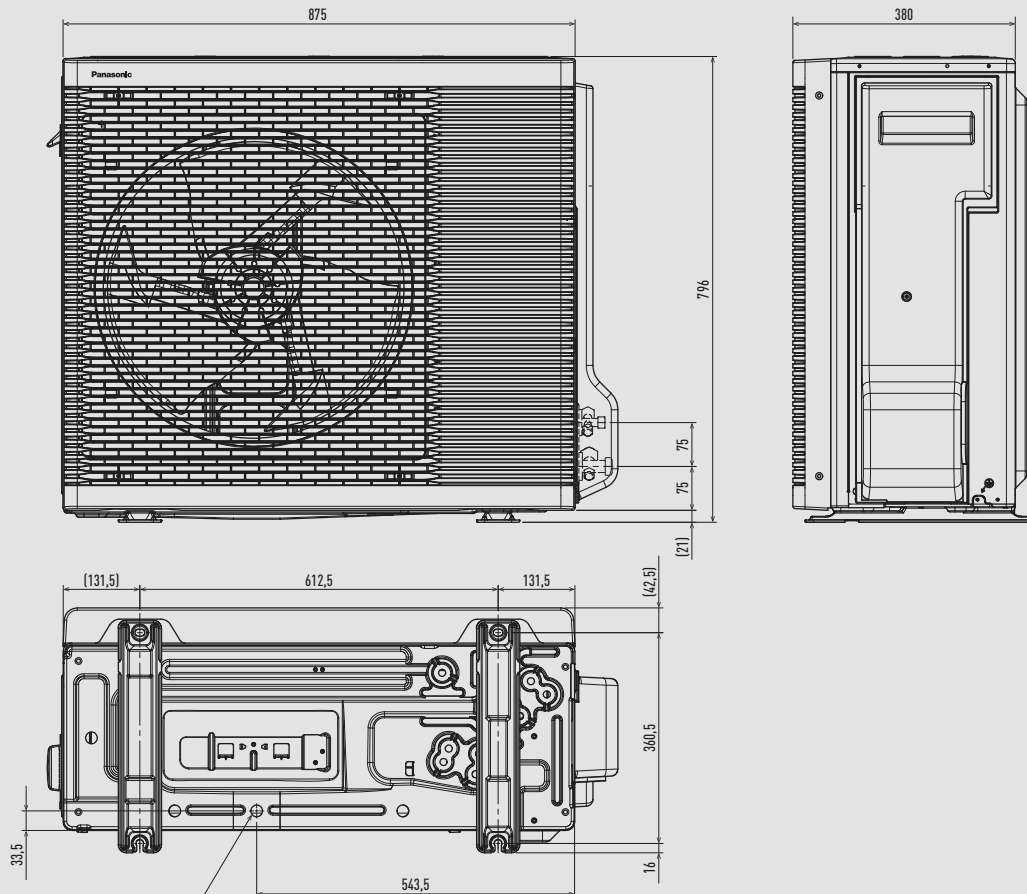

Unit: mm

Aquarea High Performance Bi-bloc outdoor unit 3 kW K Generation, 3 and 5 kW H and J Generations.

Space necessary for installation

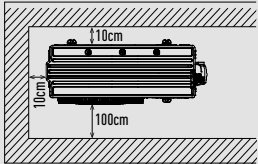

Anchor bolt pitch 355 x 260

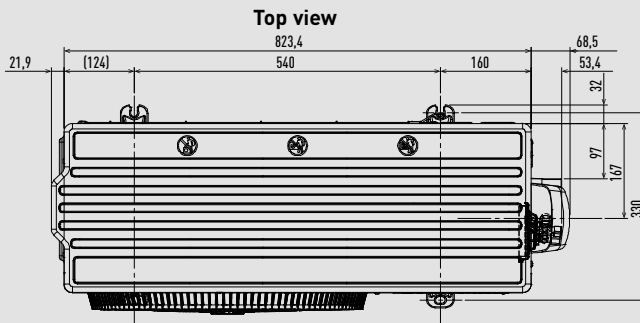

Side view

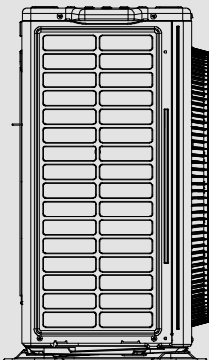

Front view

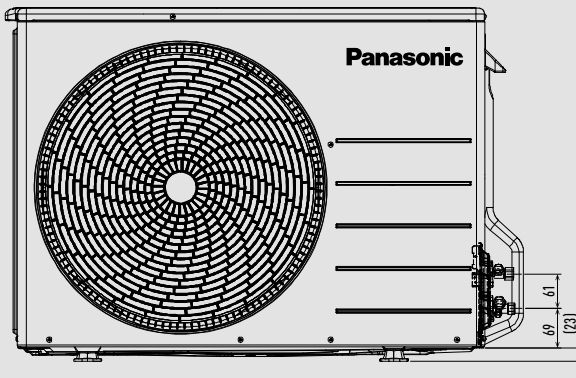

Side view

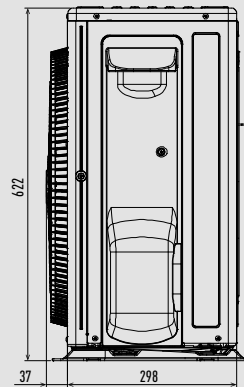

Unit: mm

Aquarea High Performance Bi-bloc outdoor units 7 and 9 kW H and J Generations.

Space necessary for installation

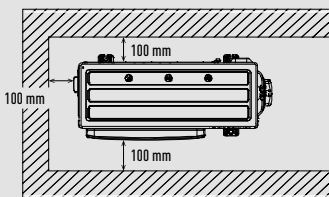

Anchor bolt pitch 360.5 x 613

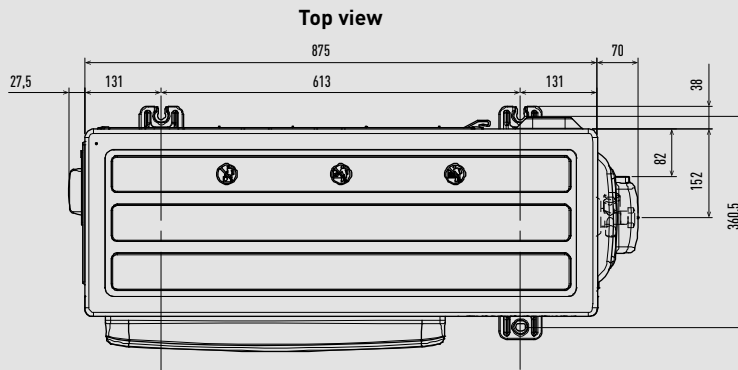

Side view

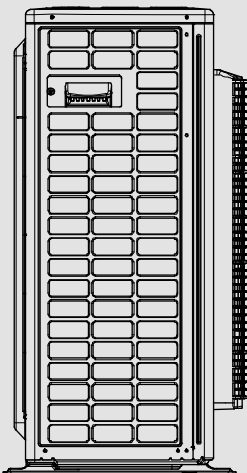

Front view

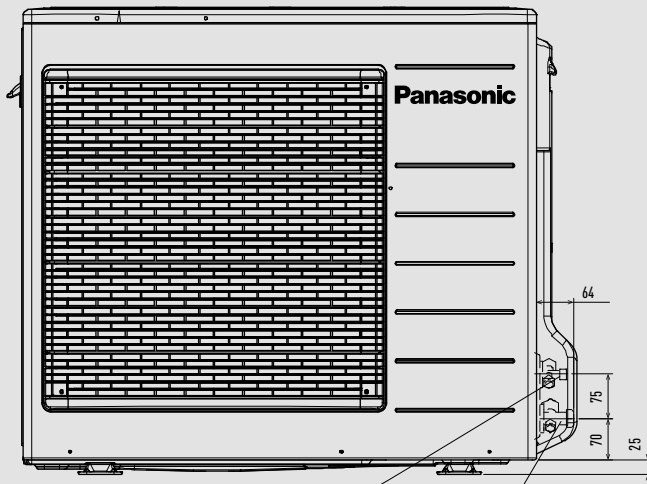

Side view

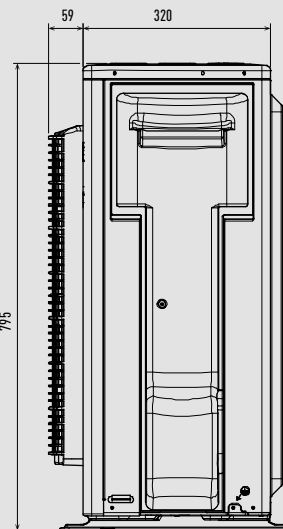

2-way valve at liquid side (high pressure)

3-way valve at gas side (low pressure)

Unit: mm

Aquarea High Performance, T-CAP and HT Bi-bloc outdoor units from 9 to 16 kW.

[Except High Performance 9 kW single phase].

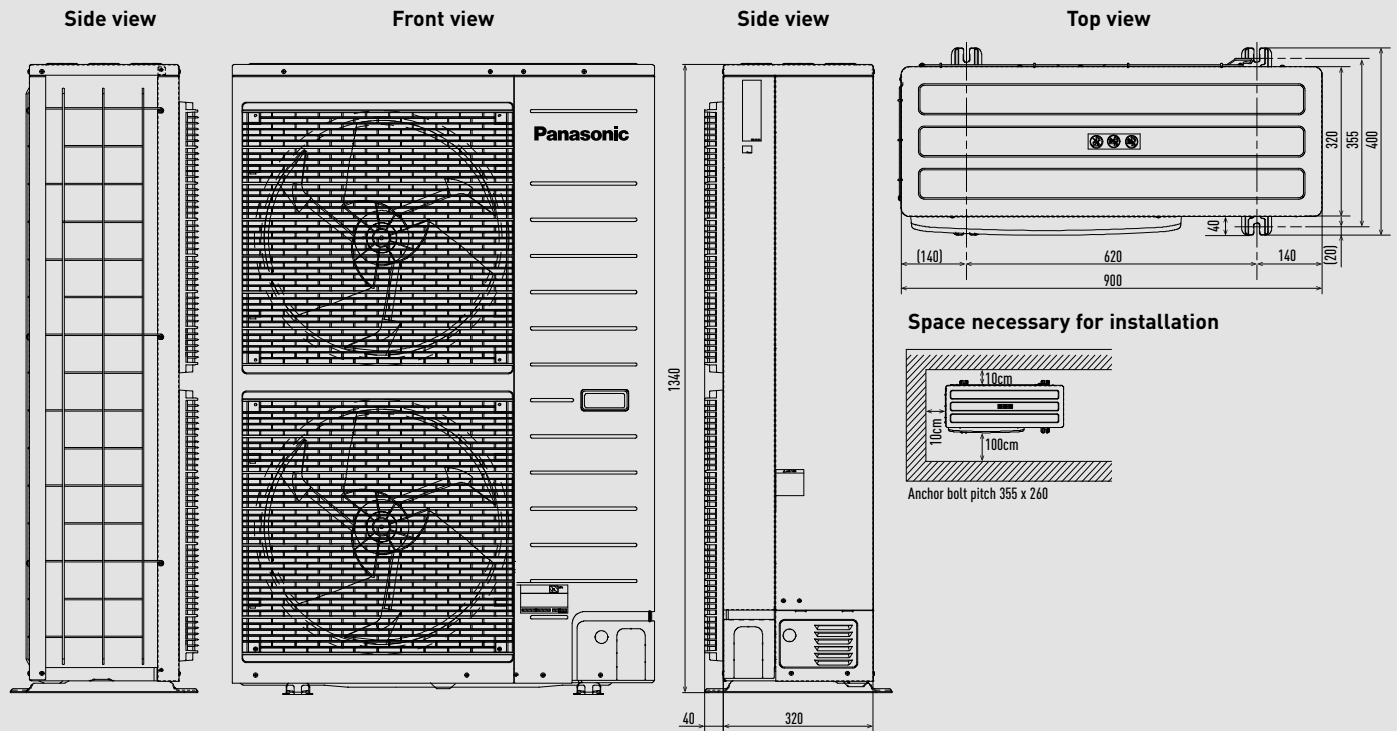

Unit: mm

Aquarea High Performance Mono-bloc outdoor units from 5 to 9 kW.

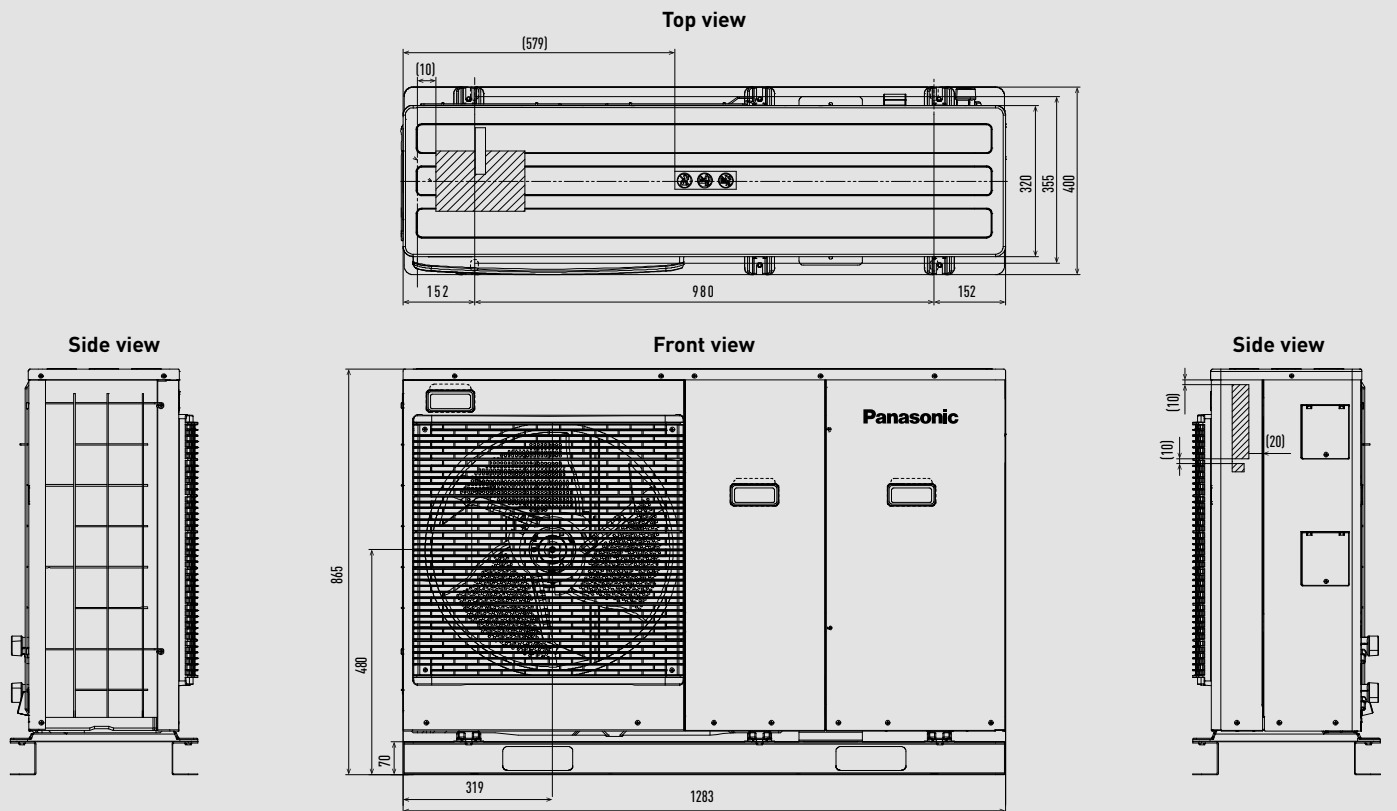

Unit: mm

Aquarea High Performance, T-CAP and HT Mono-bloc outdoor unit and T-CAP Bi-bloc Super Quiet outdoor units from 9 to 16 kW.

(Except High Performance 9 kW).

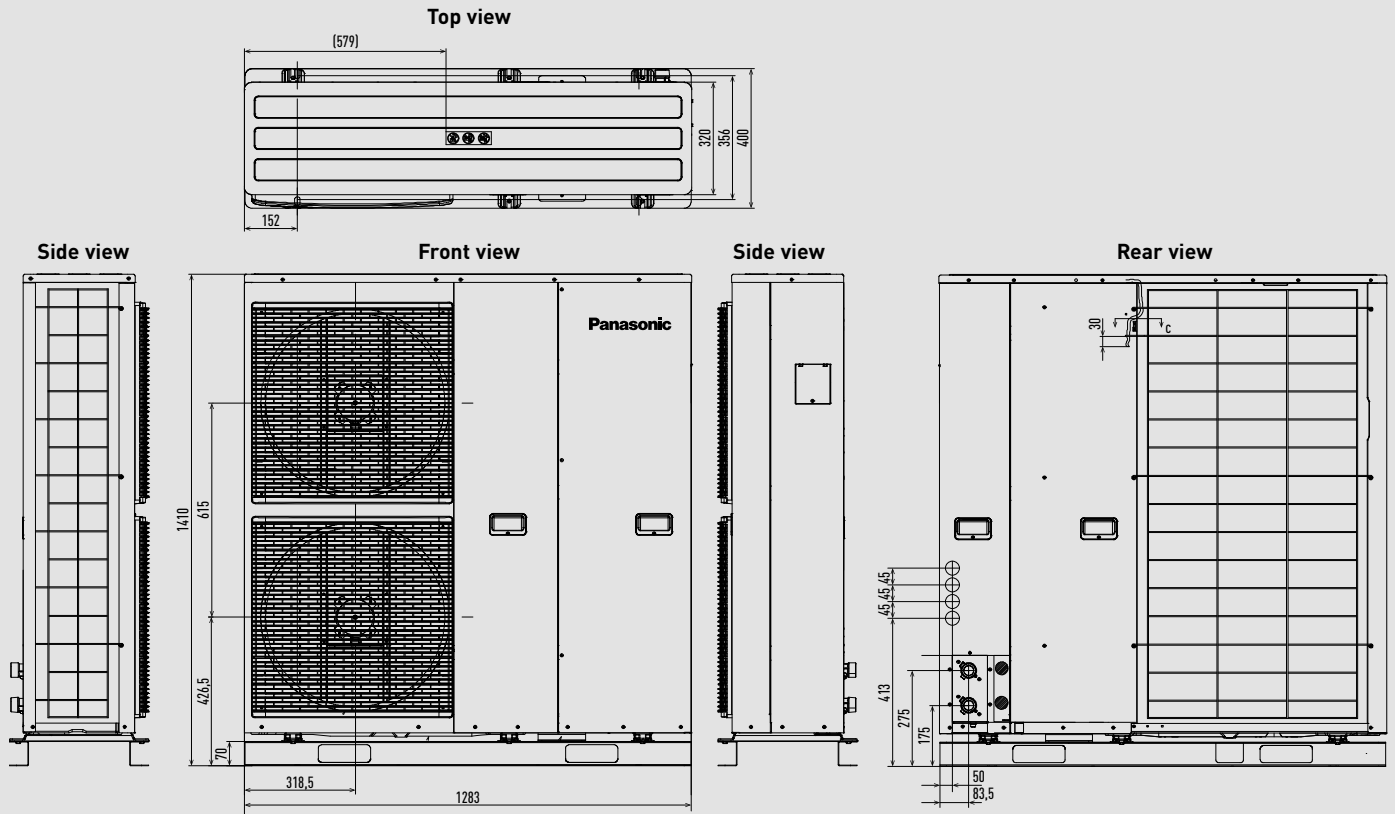

Unit: mm

Smart fan coils.

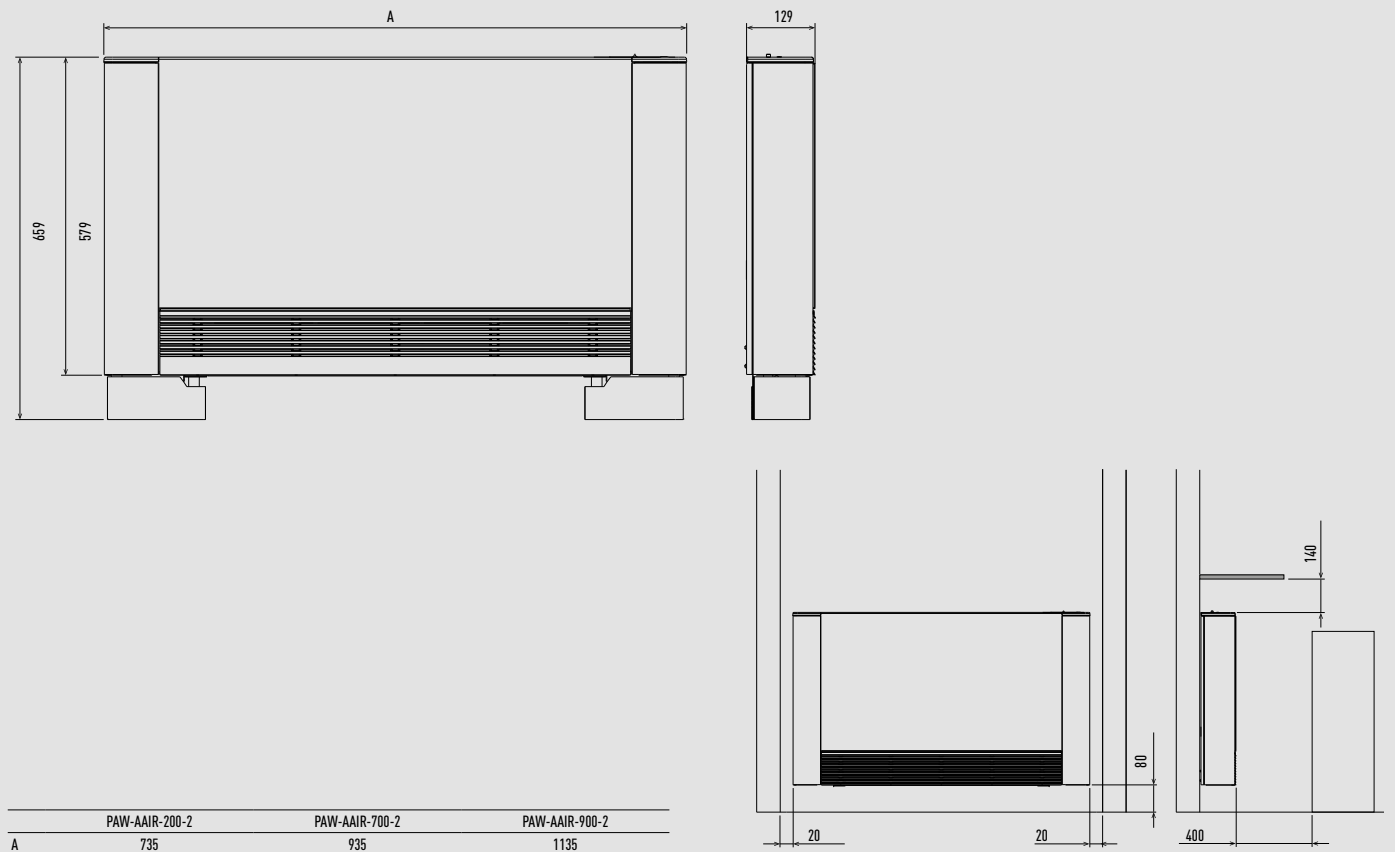

Unit: mm

Buffer tank - PAW-BTANK50L-2 / PAW-BTANK100L.

	A*	B*	C	D	E	Ø
PAW-BTANK50L-2	704	636	422	192	96	435
PAW-BTANK100L	1243	1175	962	192	96	435

Tolerance +/- 5 mm. * Total height tolerance +0 / -13 mm.

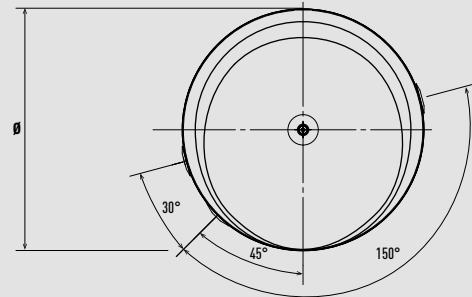
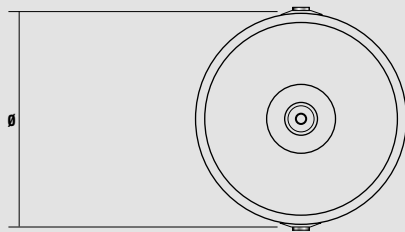
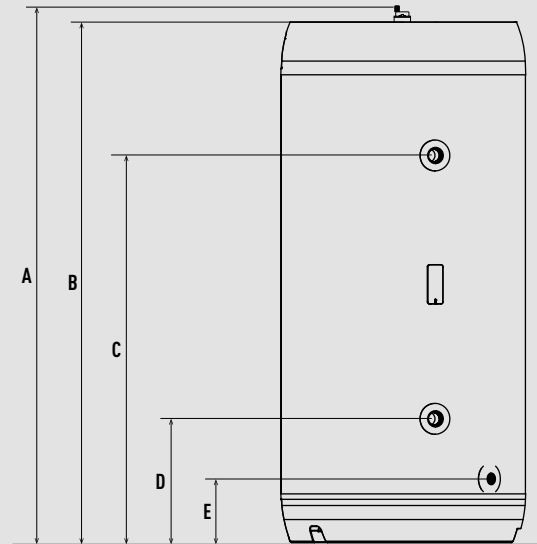
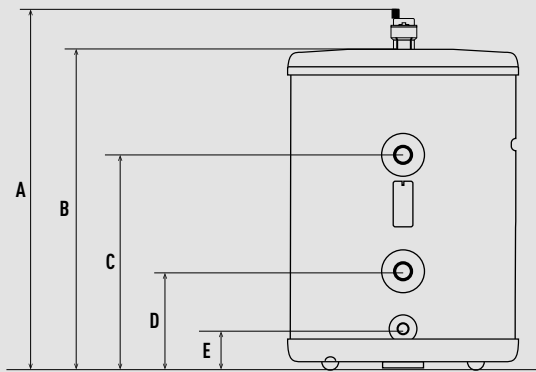

Unit: mm

Enamelled tanks - PAW-TA20C1E5STD / PAW-TA30C1E5STD / PAW-TA40C1E5STD.

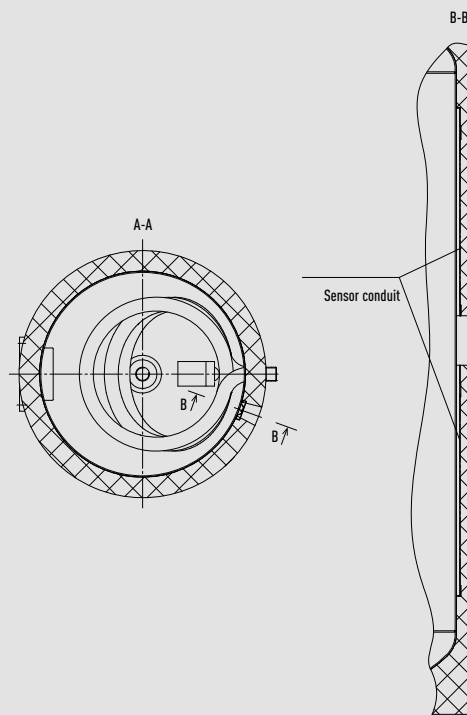
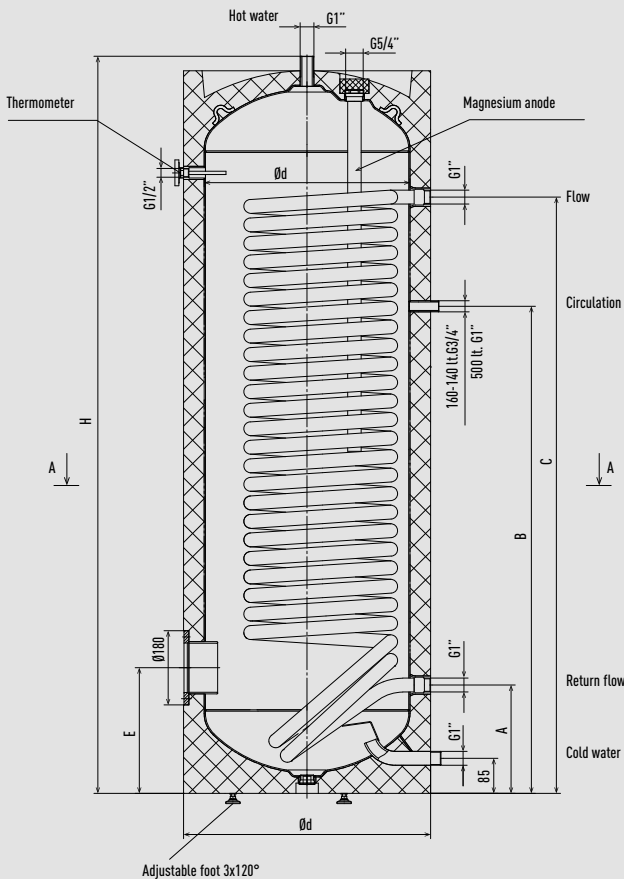

	Ød	H	A	B	C	E
PAW-TA20C1E5STD	500	1340	263	803	998	305
PAW-TA30C1E5STD	500	1797	263	983	1313	305
PAW-TA40C1E5STD	570	1832	320	1000	1460	345

Unit: mm

Enamelled tank - PAW-TA30C2E5STD.

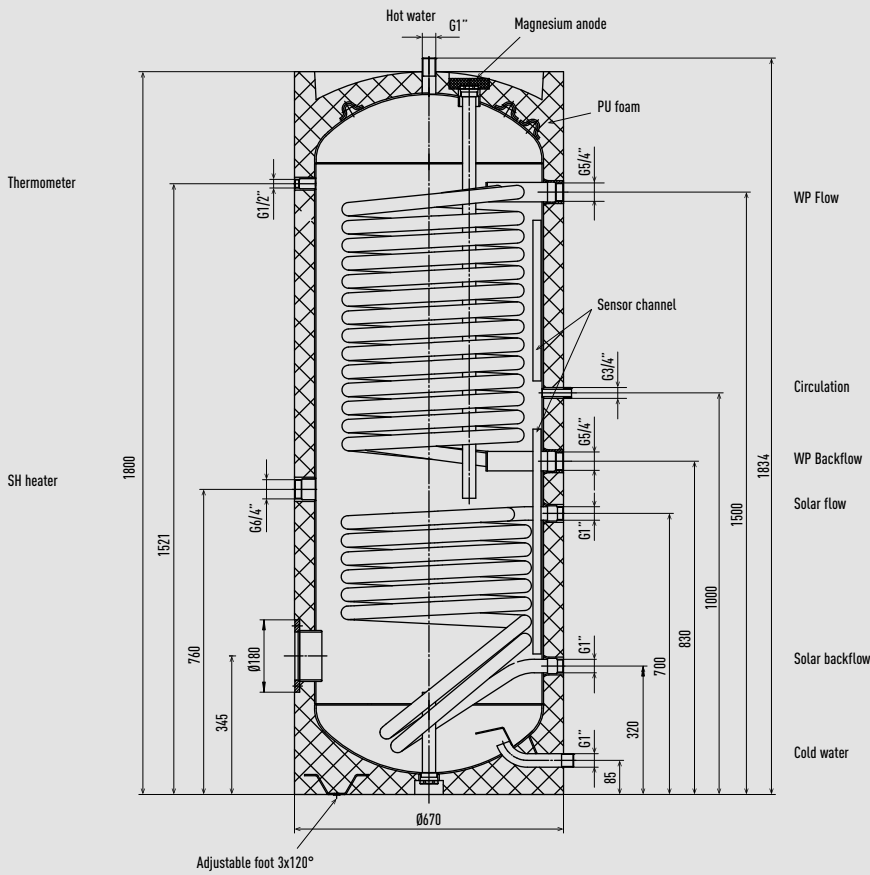

Unit: mm

Stainless steel tanks - PAW-TD20C1E5-1 / PAW-TD30C1E5-1 / PAW-TD30C1E5HI-1.

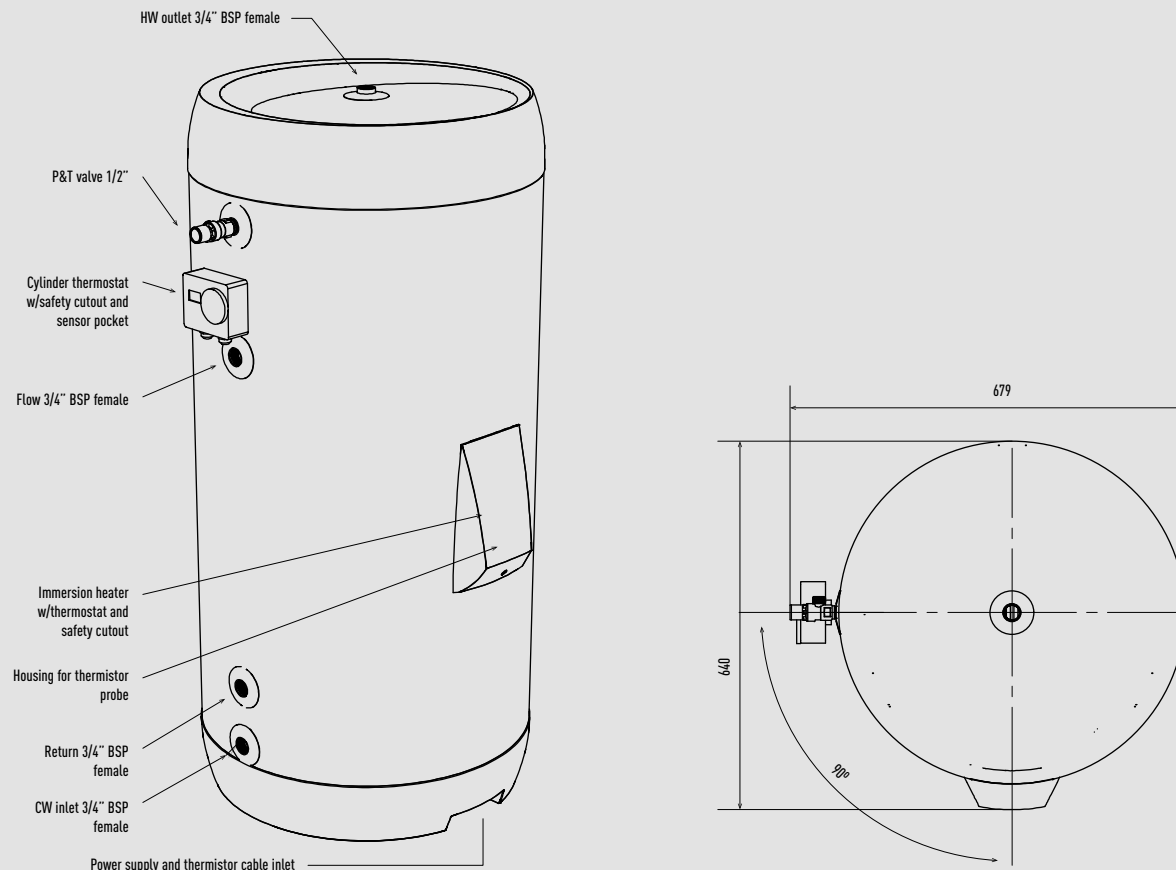

Unit: mm

Heat recovery ventilation unit.

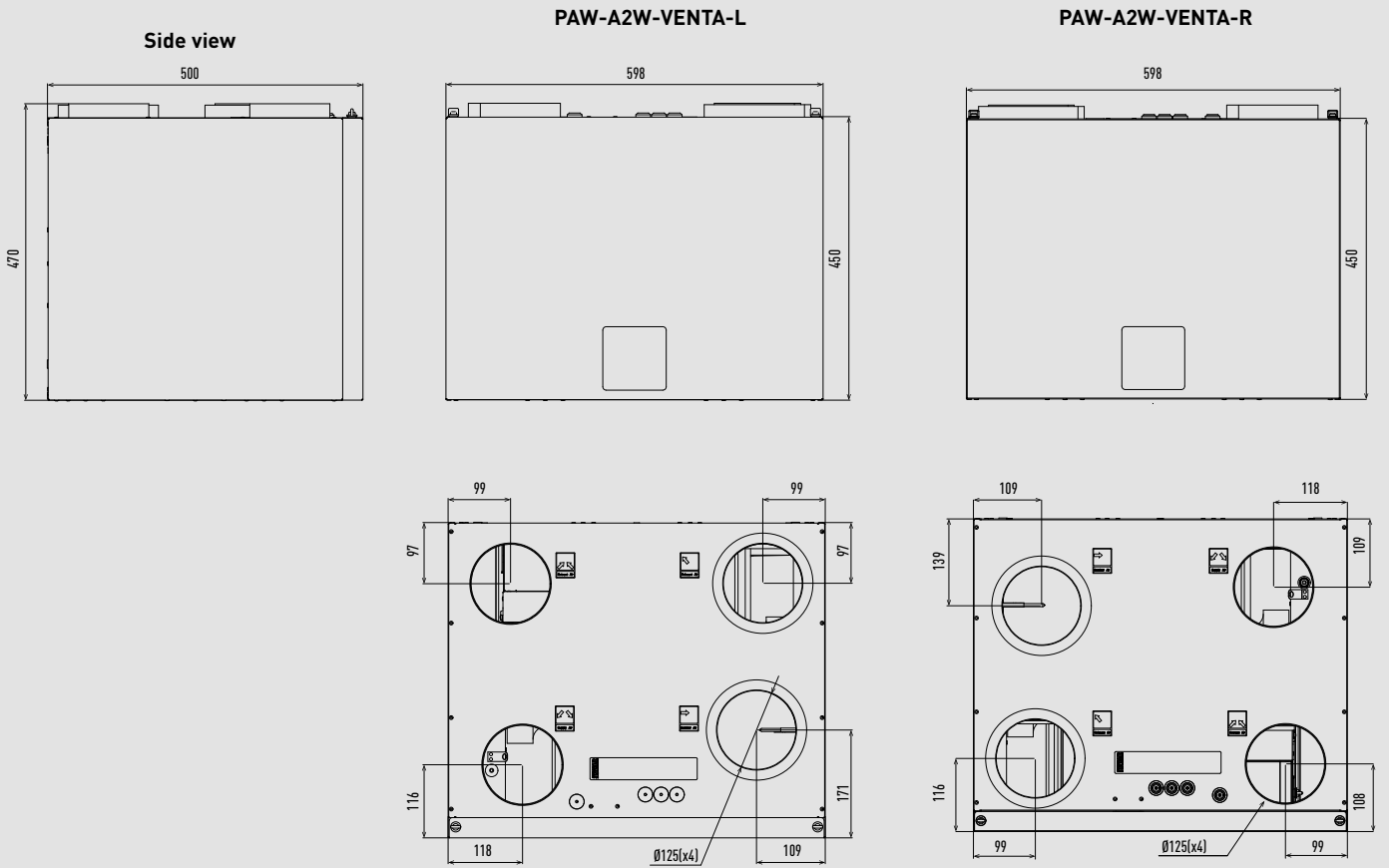

Unit: mm

Counter flow ventilation - PAW-VENTX10Z / PAW-VENTX15Z.

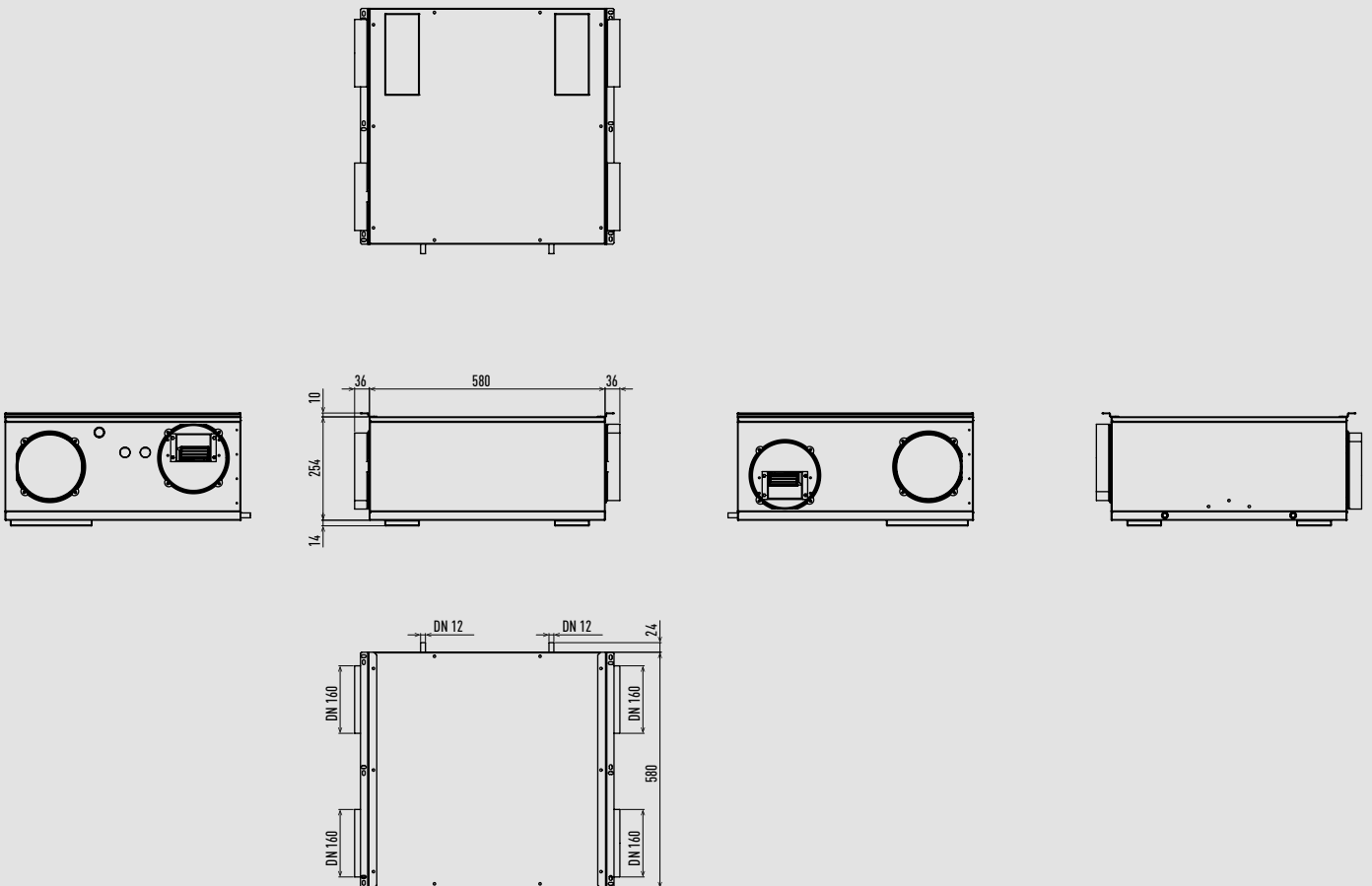

Unit: mm

Counter flow ventilation - PAW-VENTX20H / PAW-VENTX30H / PAW-VENTX40H.

PAW-VENTX20H

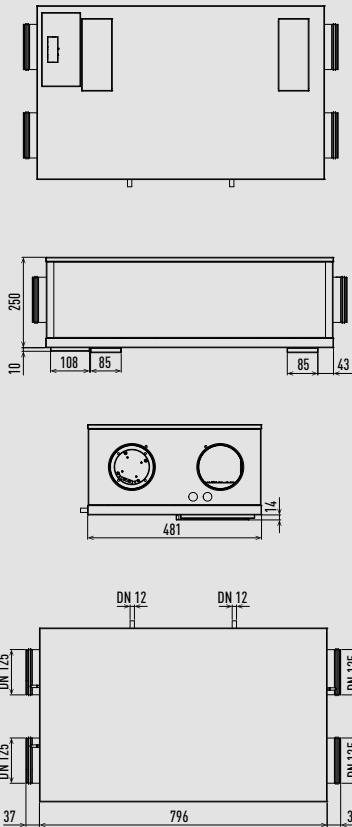

PAW-VENTX30H

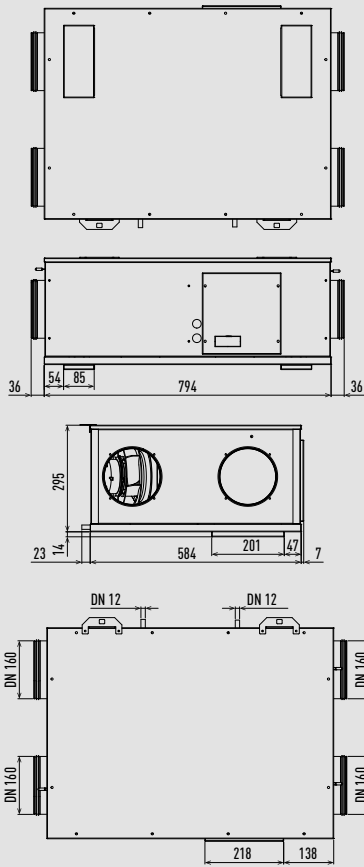

PAW-VENTX40H

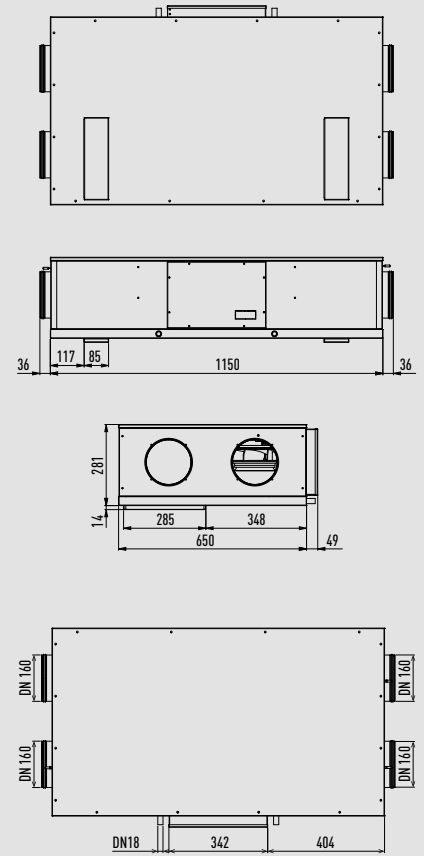

Unit: mm

Counter flow ventilation - PAW-VENTX20V / PAW-VENTX30V / PAW-VENTX40V.

PAW-VENTX20V

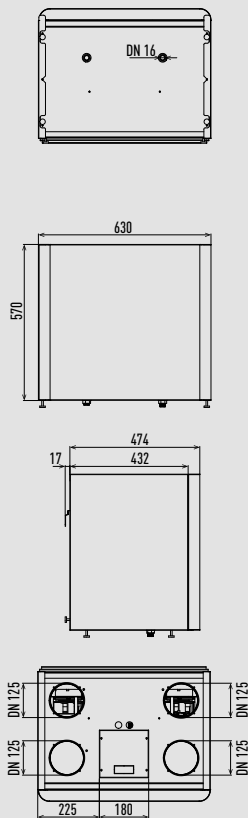

PAW-VENTX30V

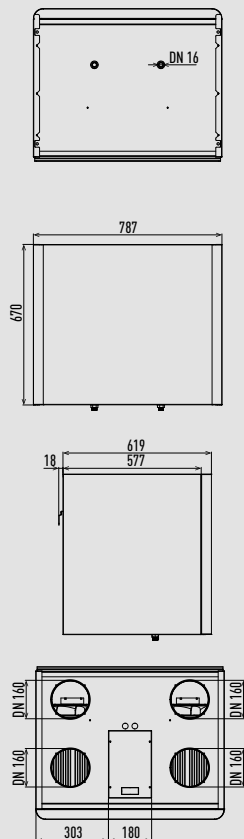

PAW-VENTX40V

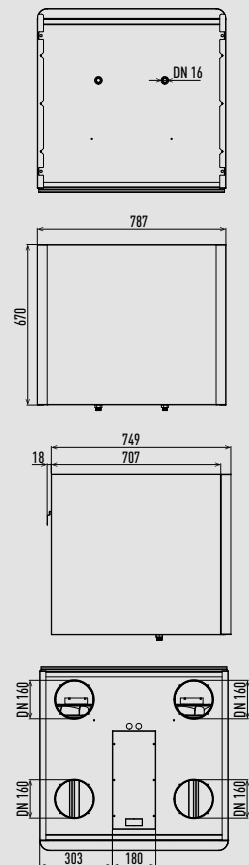

Unit: mm

DHW Stand Alone.

Wall-mounted

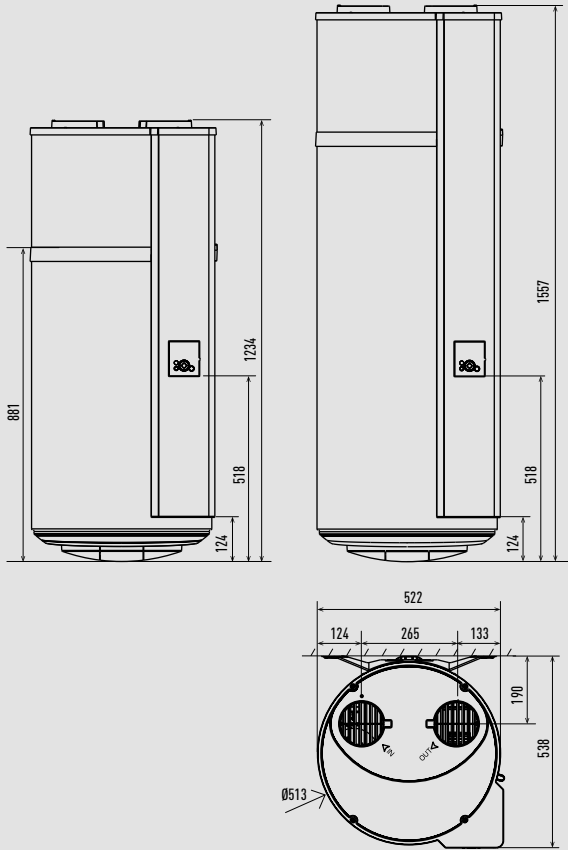

Floor-standing

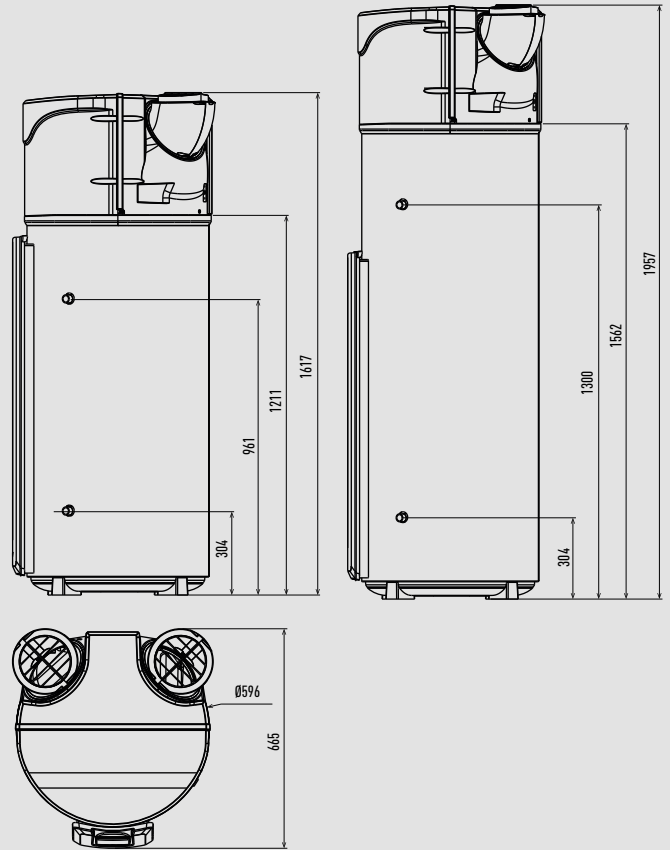

Unit: mm

Wall-mounted Heatcharge VZ.

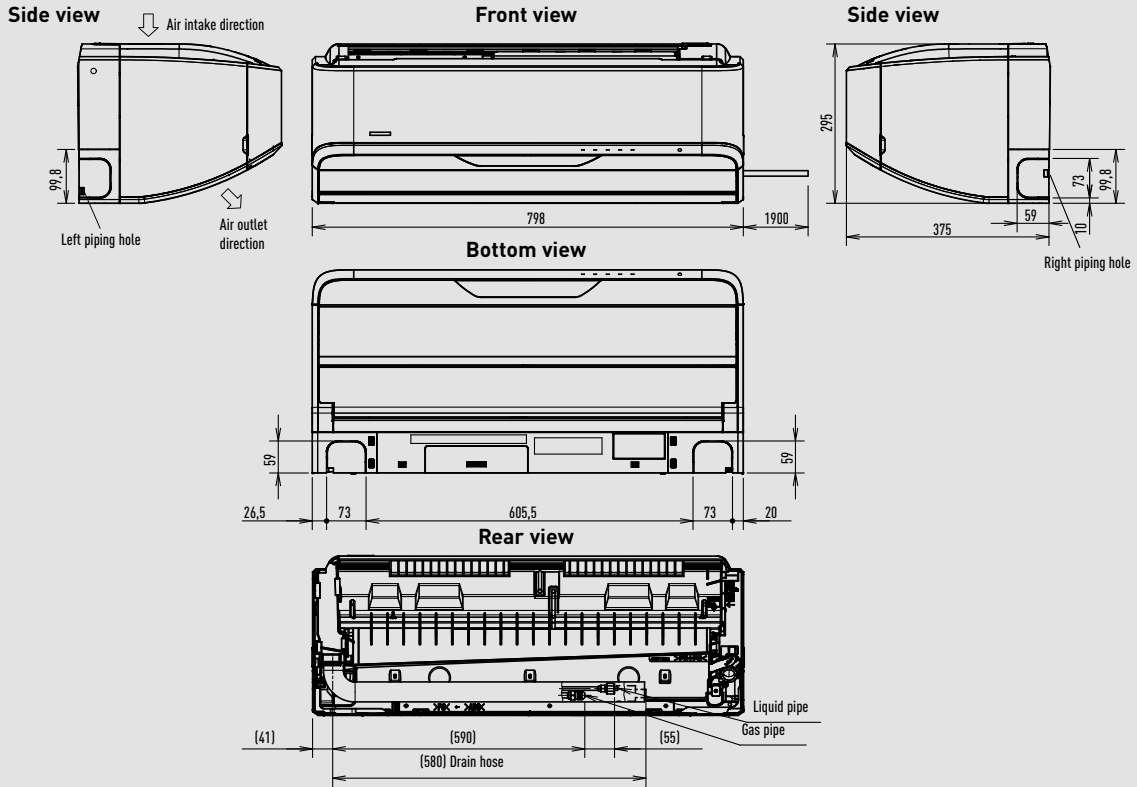

Relative position between the indoor unit and the installation plate

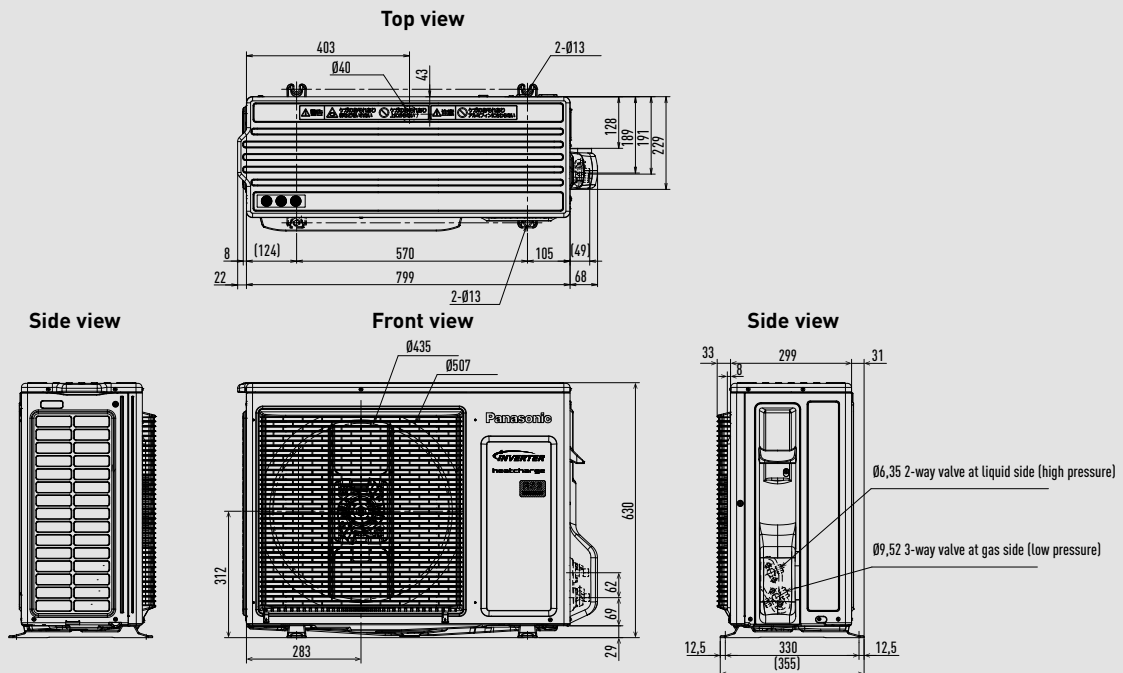
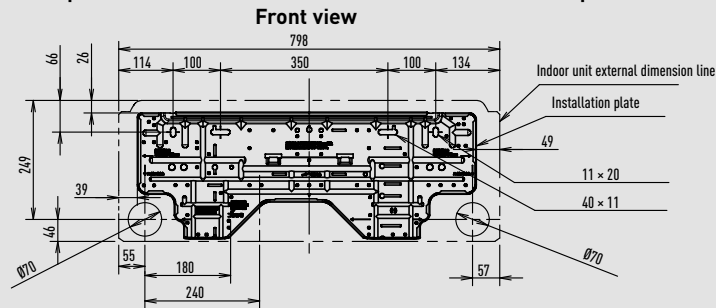

Unit: mm

Wall-mounted Etherea (from 1,6 to 4,2 kW).

Side view

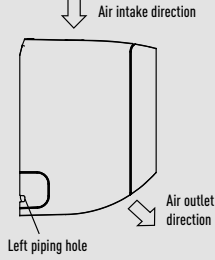

Front view

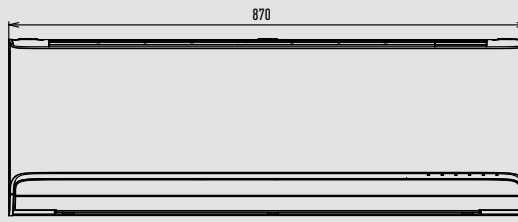

Side view

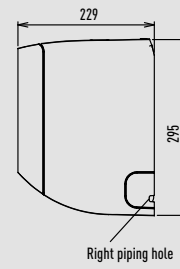

Bottom view

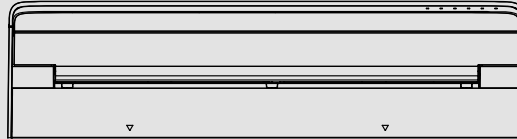

Rear view

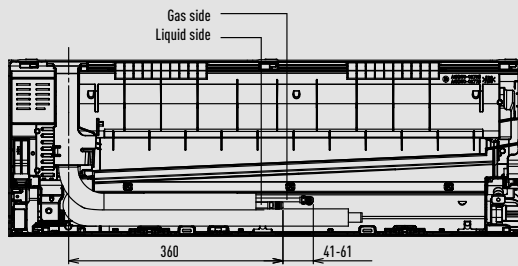

Relative position between the indoor unit and the installation plate

Front view

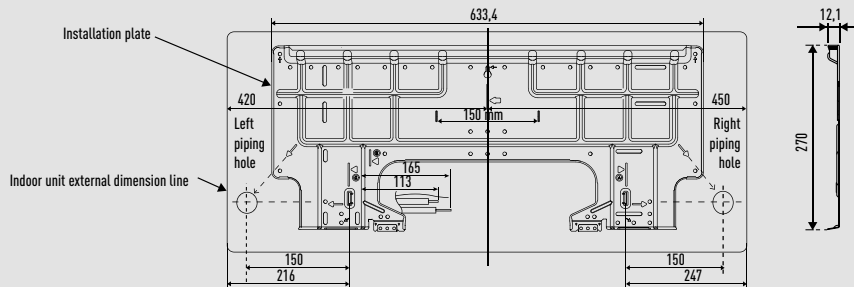

Top view

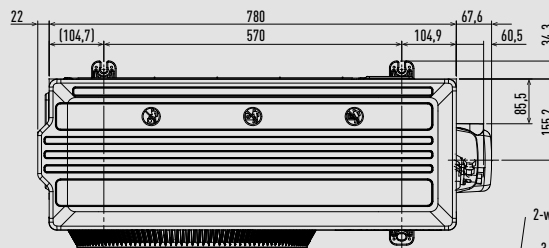

Side view

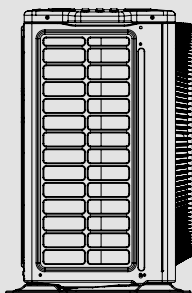

Front view

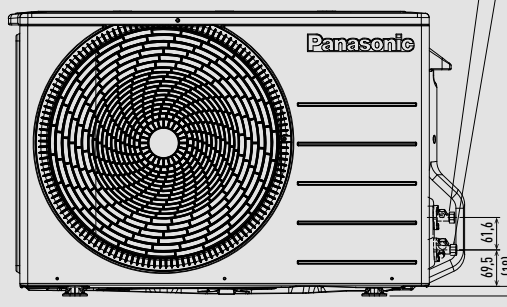

Side view

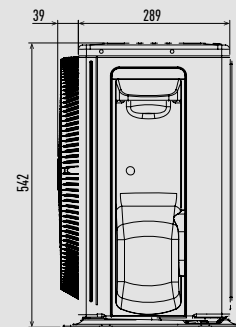

Wall-mounted Etherea (5,0 and 7,1 kW).

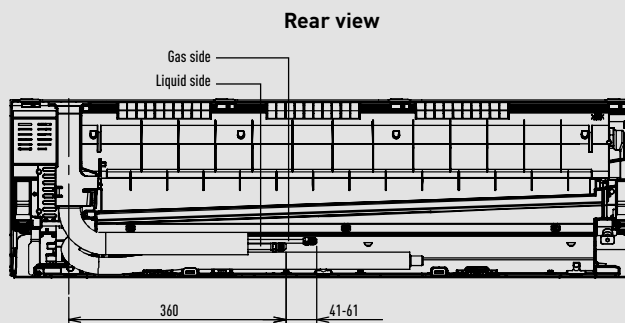
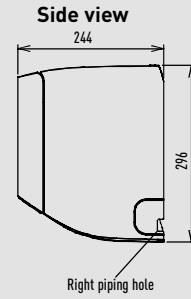
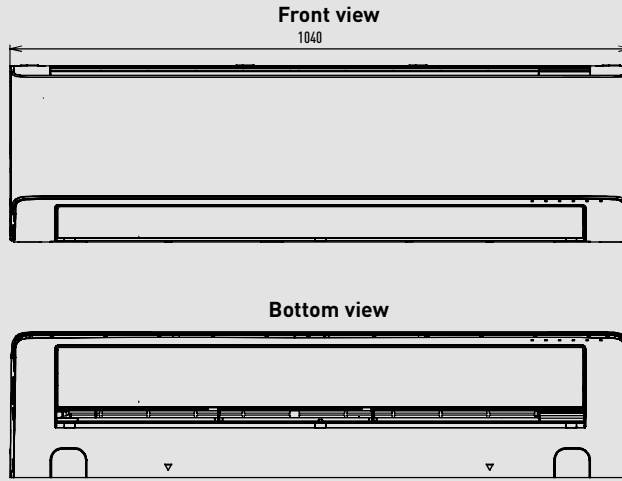
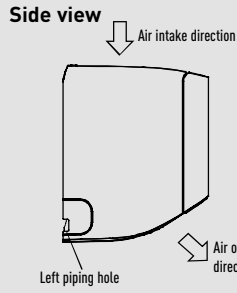

Relative position between the indoor unit and the installation plate

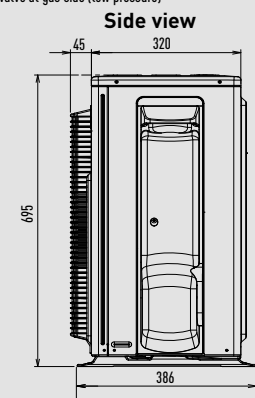
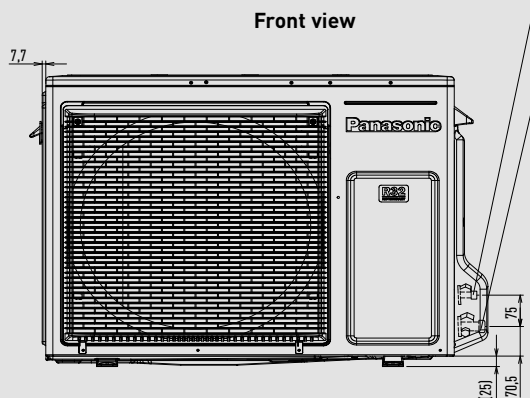
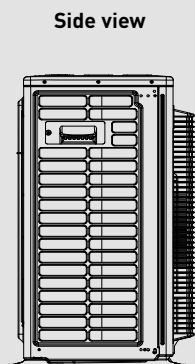
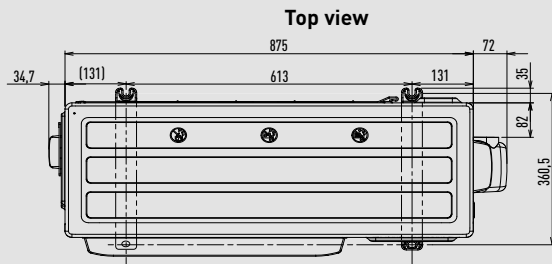
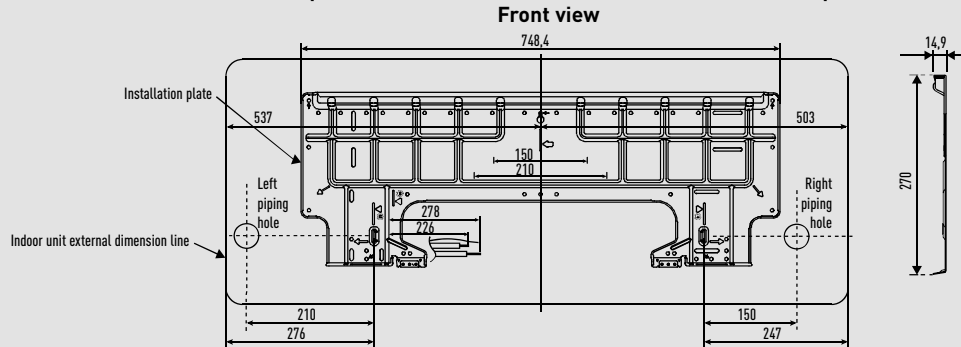

Unit: mm

Wall-mounted TZ super-compact (from 1,6 to 5,0 kW).

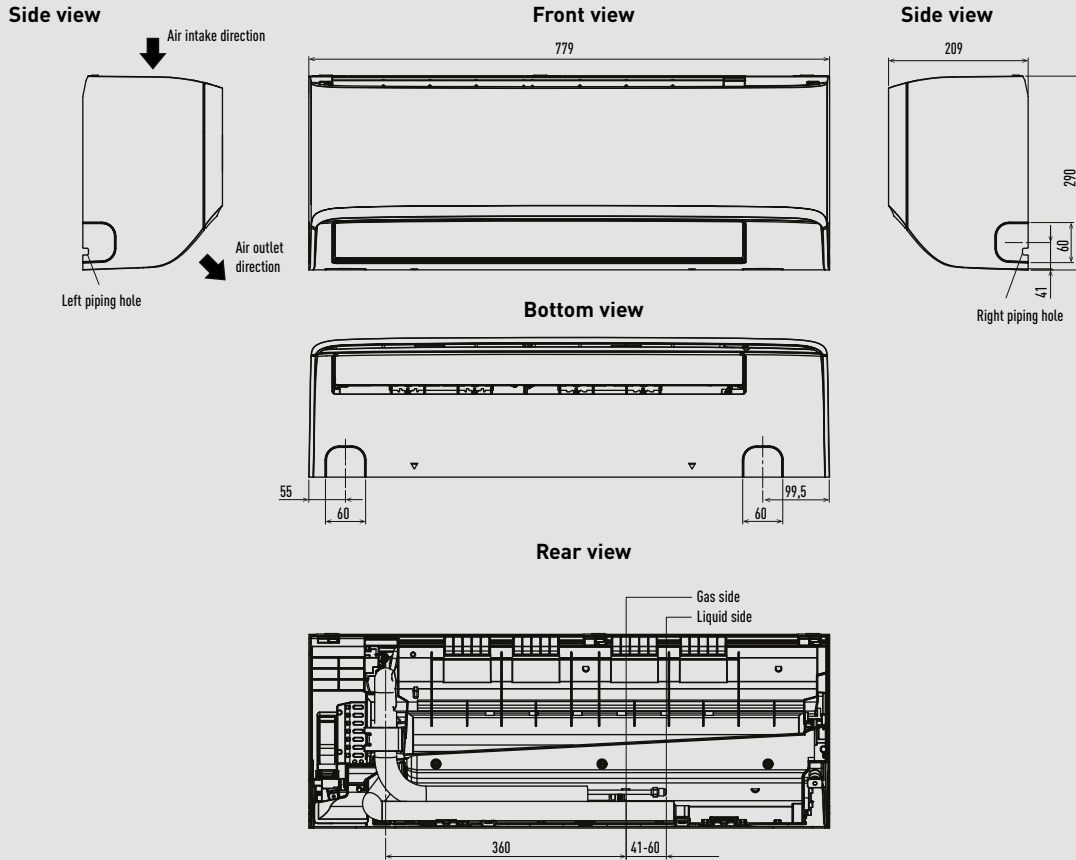

Relative position between the indoor unit and the installation plate
Front view

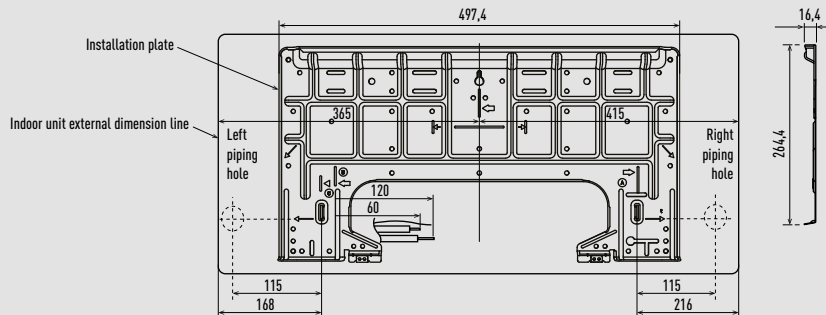

CU-TZ20ZKE / CU-TZ25ZKE / CU-TZ35ZKE / CU-TZ42ZKE

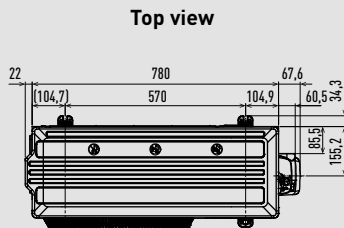

CU-TZ50ZKE

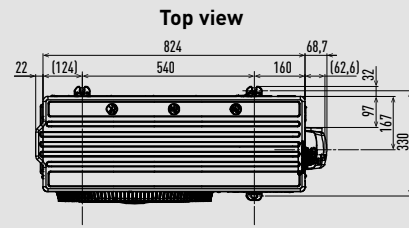

Side view

Front view

Side view

Side view

Front view

Side view

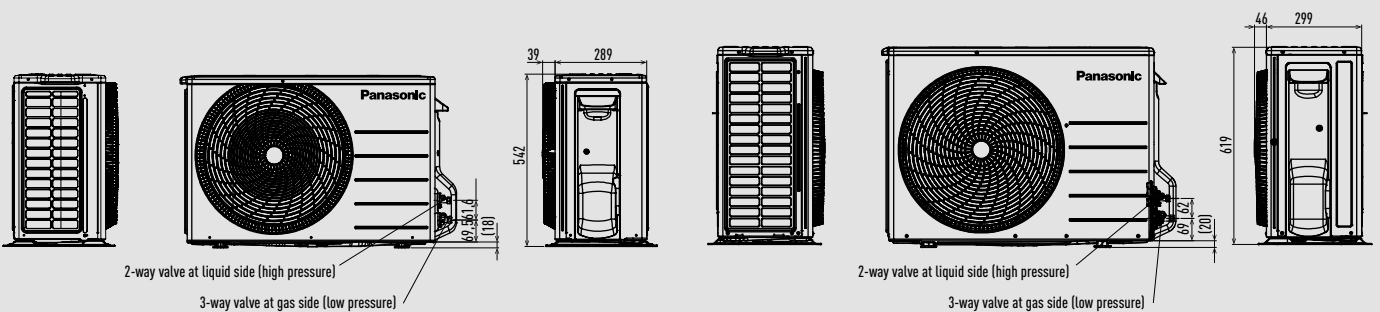

Unit: mm

Wall-mounted TZ super-compact (6,0 and 7,1 kW).

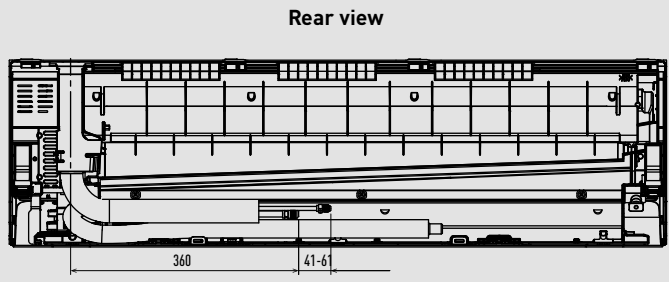
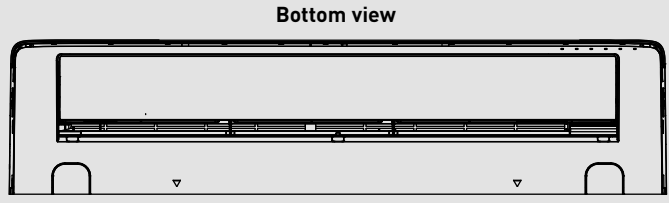
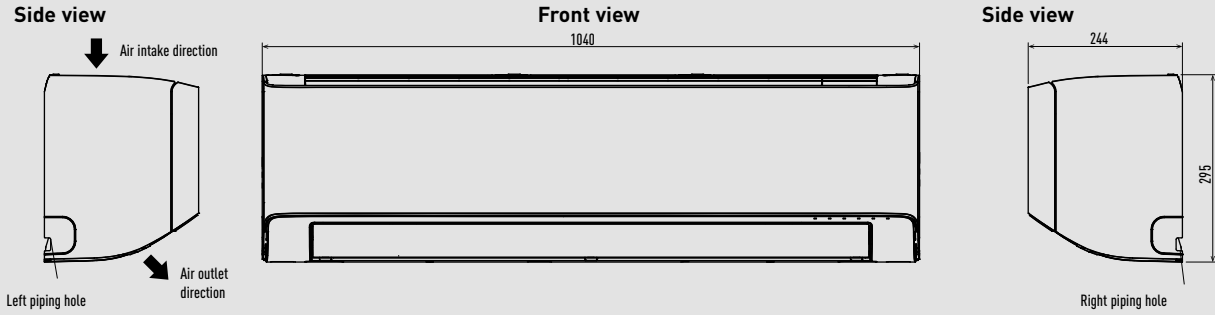

Relative position between the indoor unit and the installation plate
 Front view

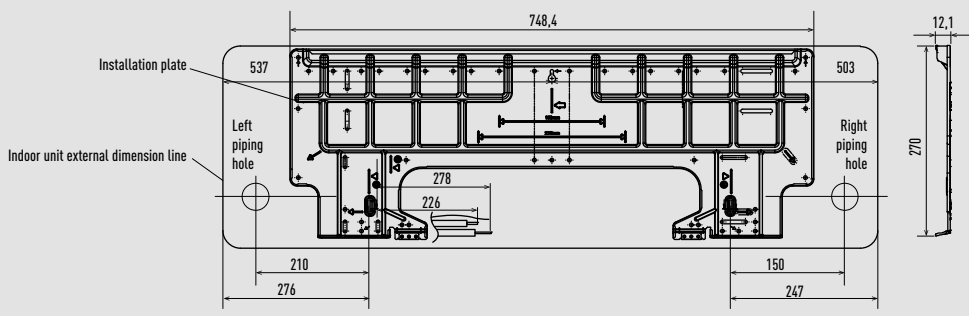

CU-TZ60ZKE

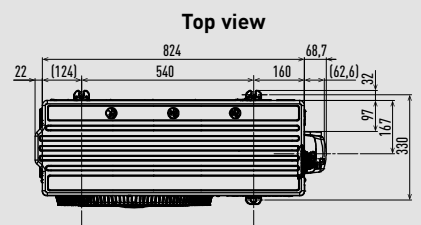

CU-TZ71ZKE

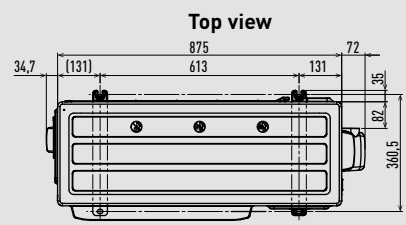

Side view

Front view

Side view

Side view

Front view

Side view

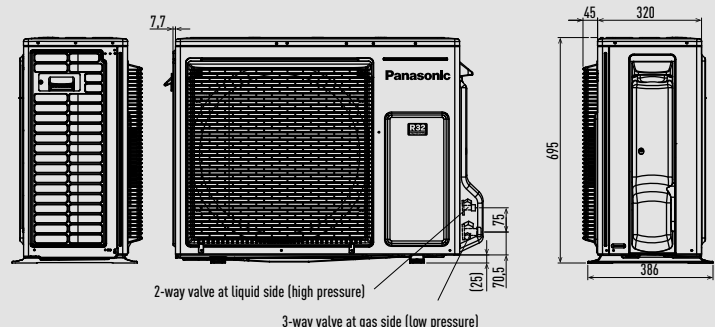
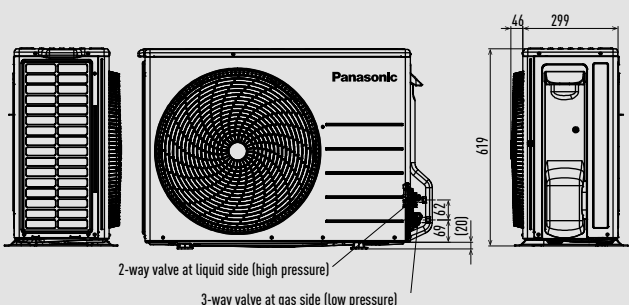

Unit: mm

Wall-mounted BZ super-compact.

Side view

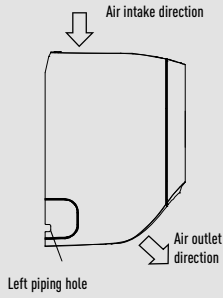

Front view



Side view

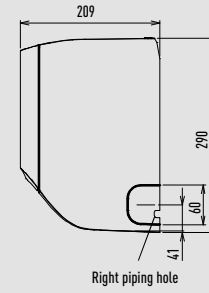

Bottom view

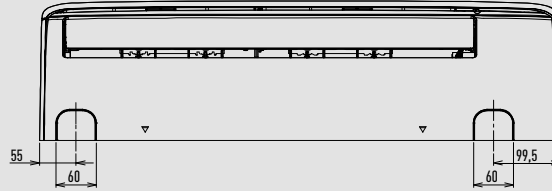

Rear view

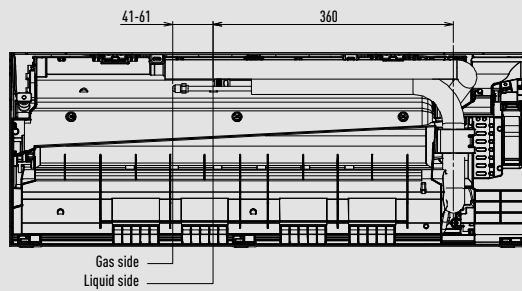

Relative position between the indoor unit and the installation plate
Front view

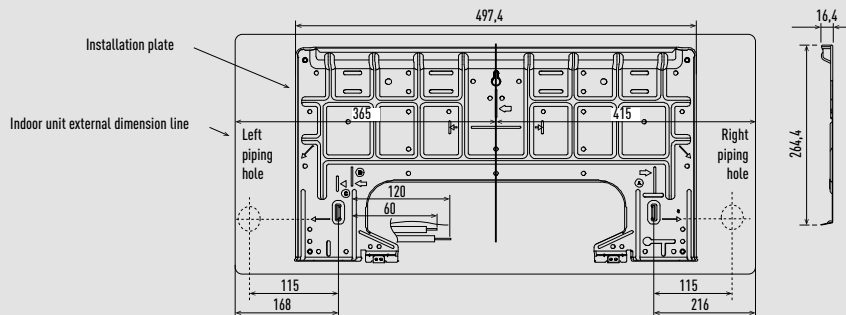

CU-BZ25ZKE / CU-BZ35ZKE

Top view

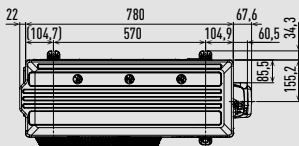

Front view

Side view

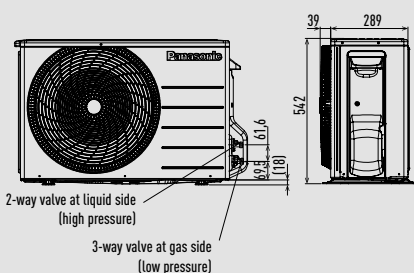

CU-BZ50ZKE

Top view

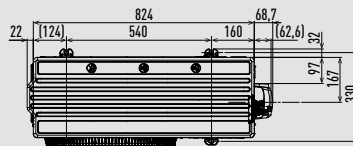

Front view

Side view

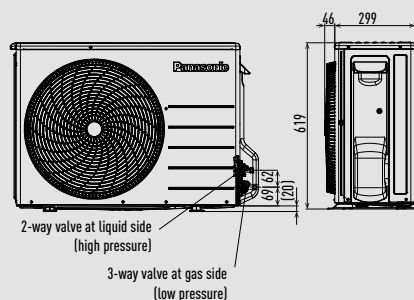

CU-BZ60ZKE

Top view

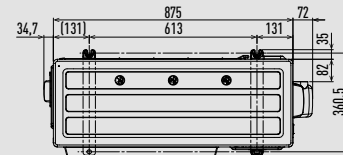

Front view

Side view

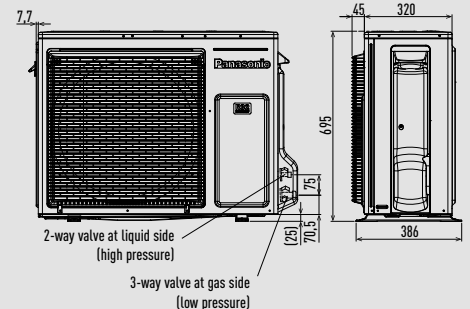

Unit: mm

Wall-mounted UZ super-compact.

Side view

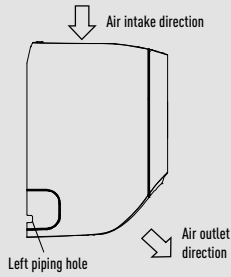

Front view

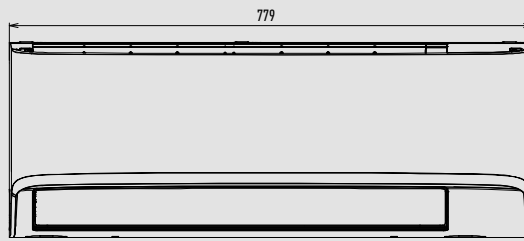

Side view

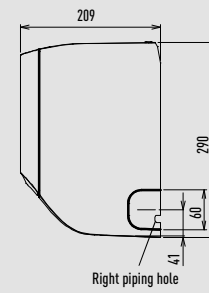

Bottom view

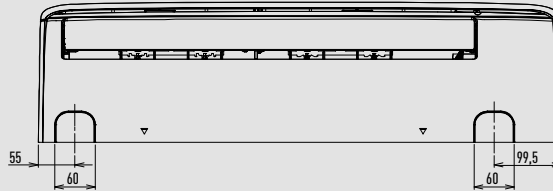

Rear view

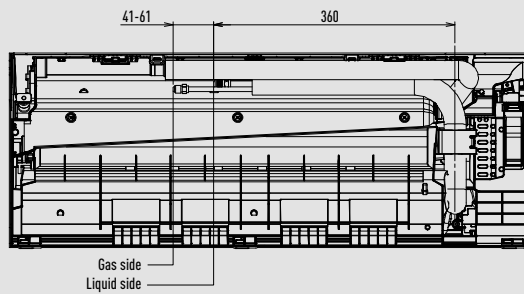

Relative position between the indoor unit and the installation plate
Front view

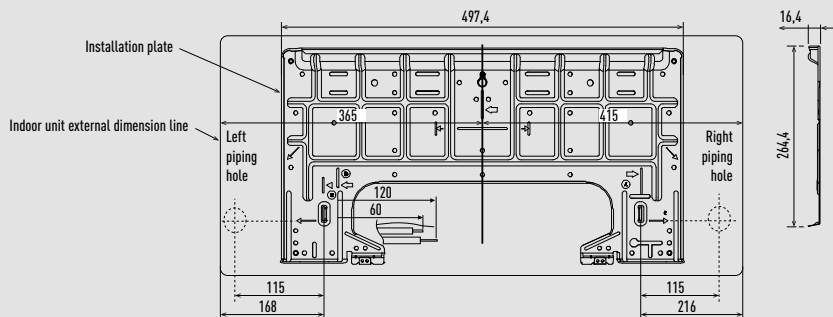

CU-UZ25ZKE / CU-UZ35ZKE

Top view

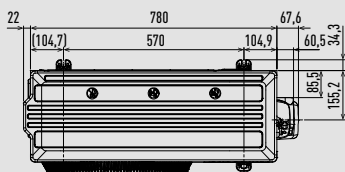

CU-UZ50ZKE

Top view

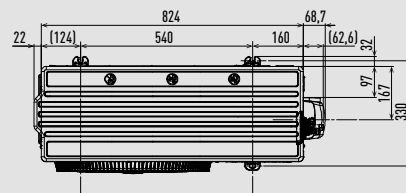

Side view

Front view

Side view

Side view

Front view

Side view

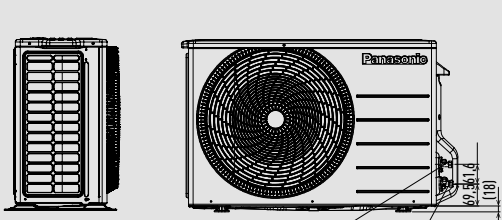

2-way valve at liquid side (high pressure)
3-way valve at gas side (low pressure)

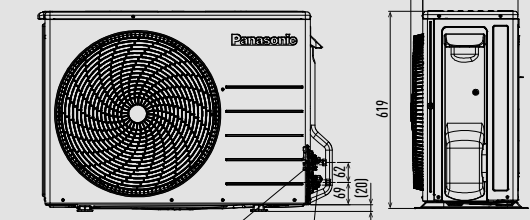
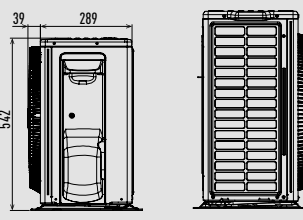

2-way valve at liquid side (high pressure)
3-way valve at gas side (low pressure)

Floor console.

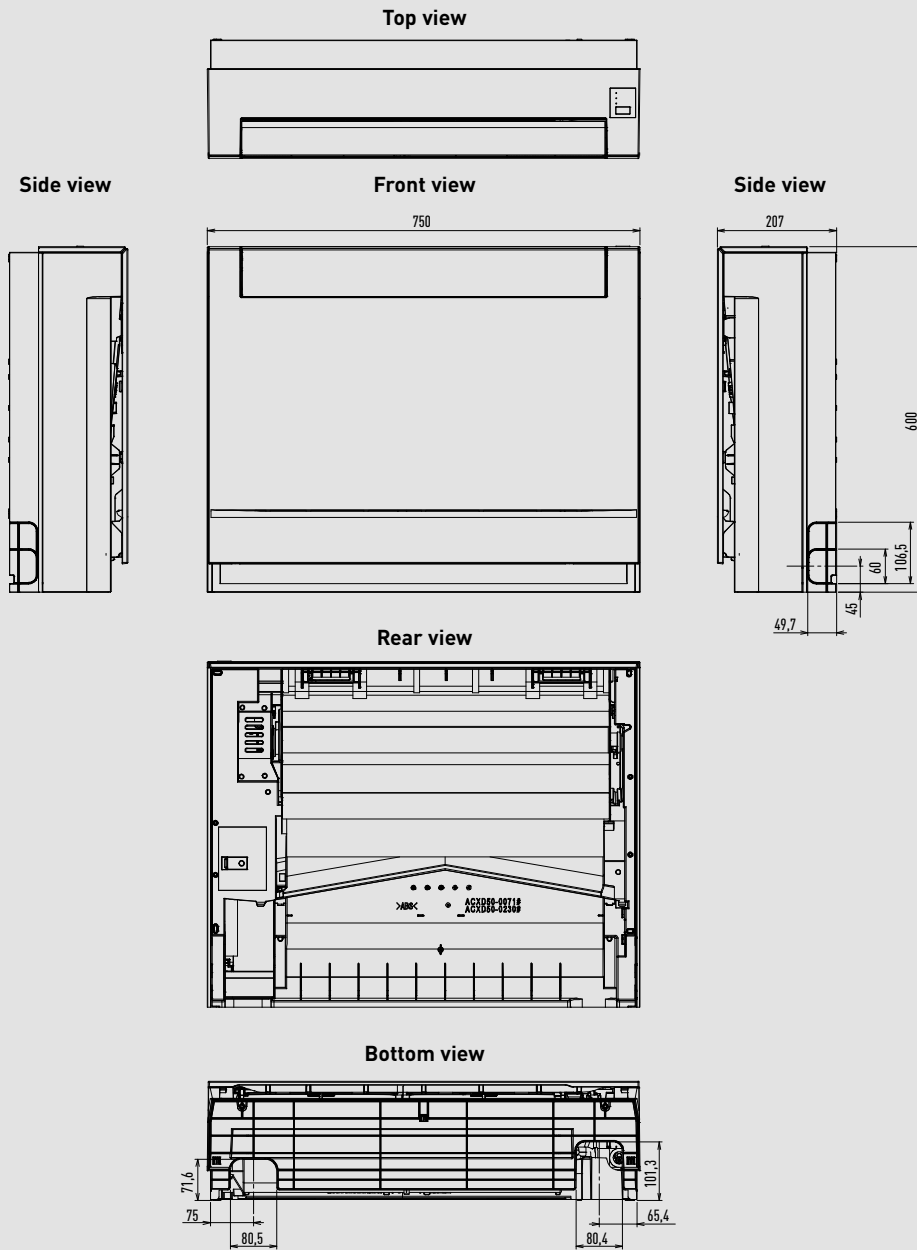

CU-Z25UBEA

CU-Z35UBEA

CU-Z50UBEA

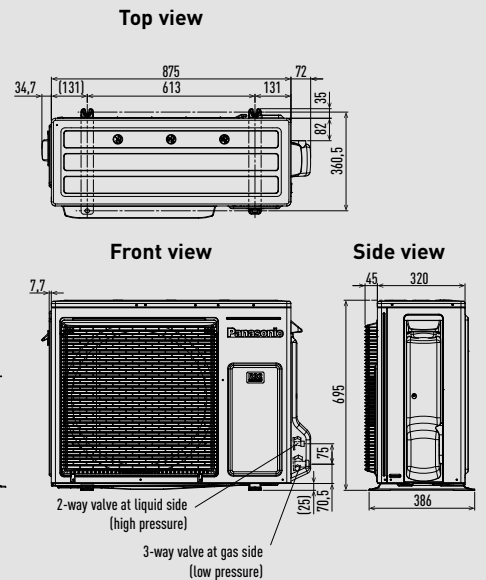
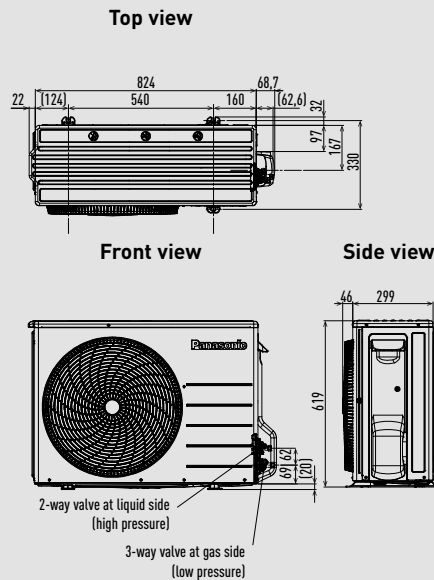
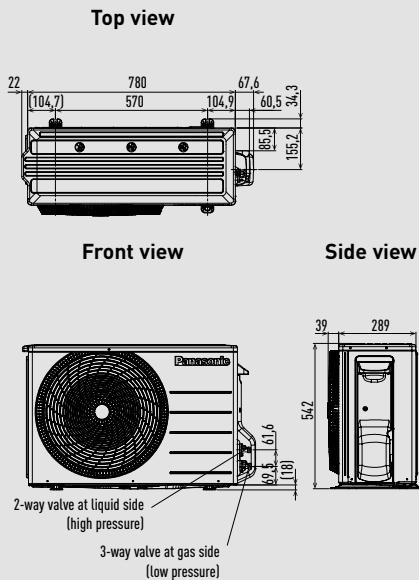

Unit: mm

Low static pressure hide-away.

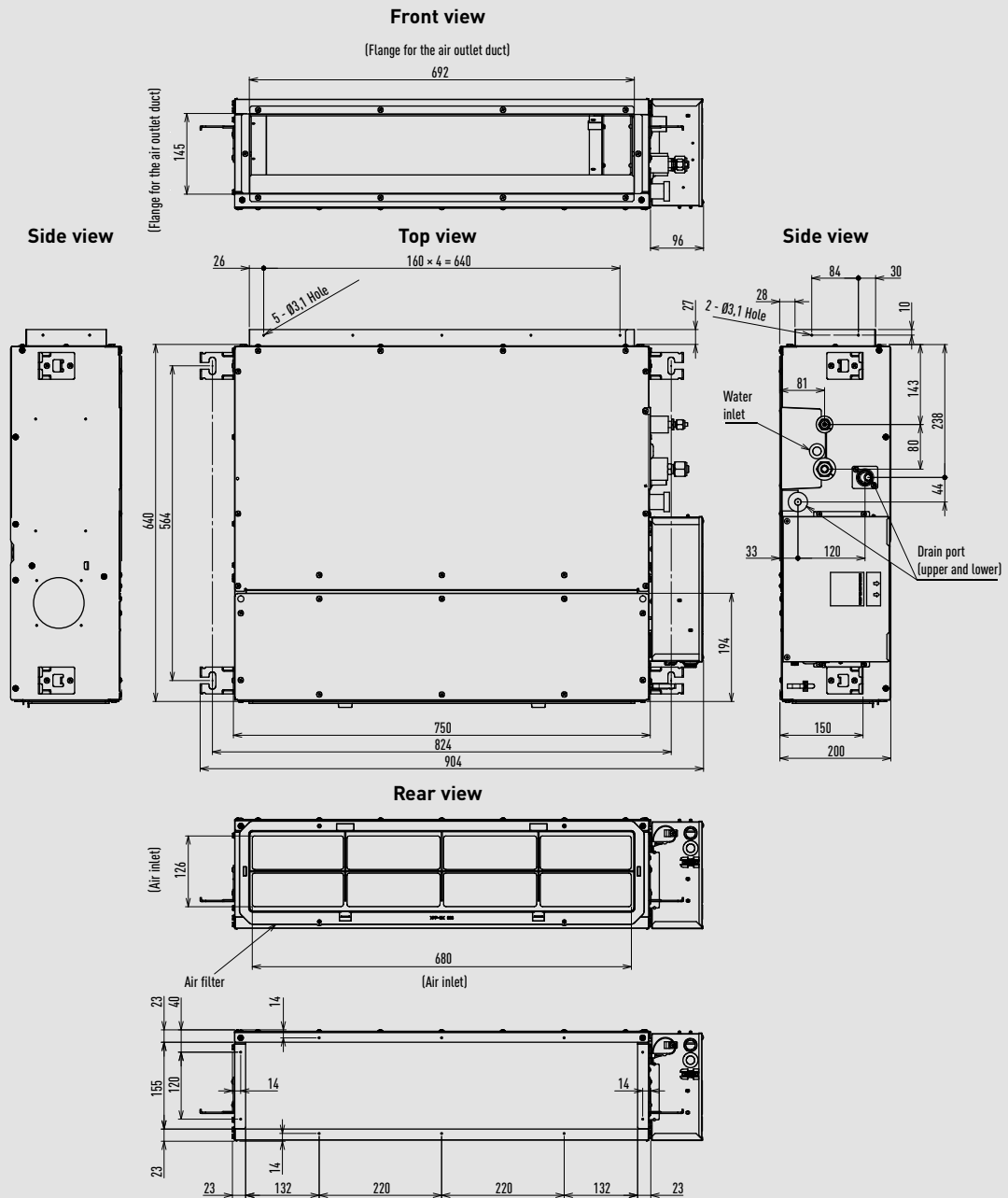

CU-Z25UBEA

CU-Z35UBEA

CU-Z50UBEA / CU-Z60UBEA

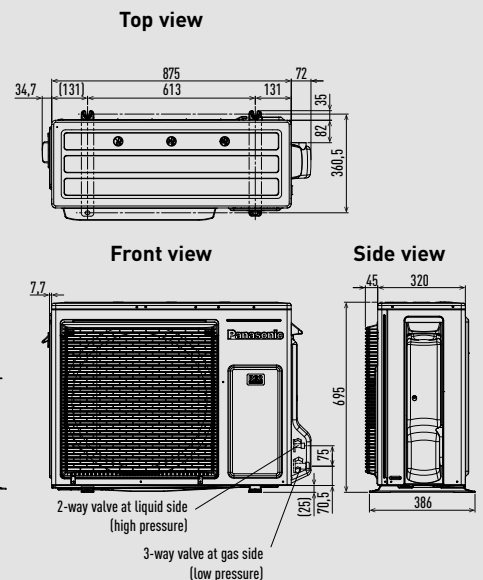
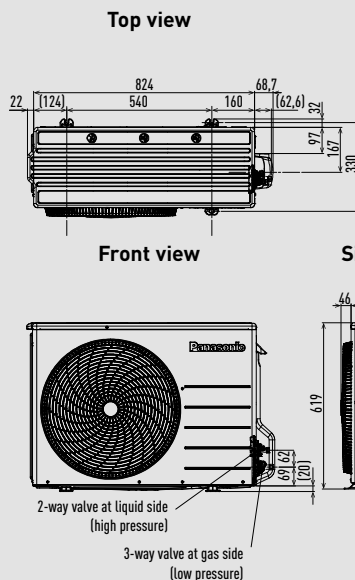
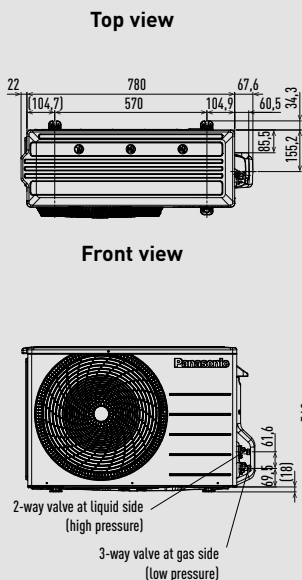

Unit: mm

Outdoor units Free Multi System Z.

CU-2Z35TBE / CU-2Z41TBE / CU-2Z50TBE

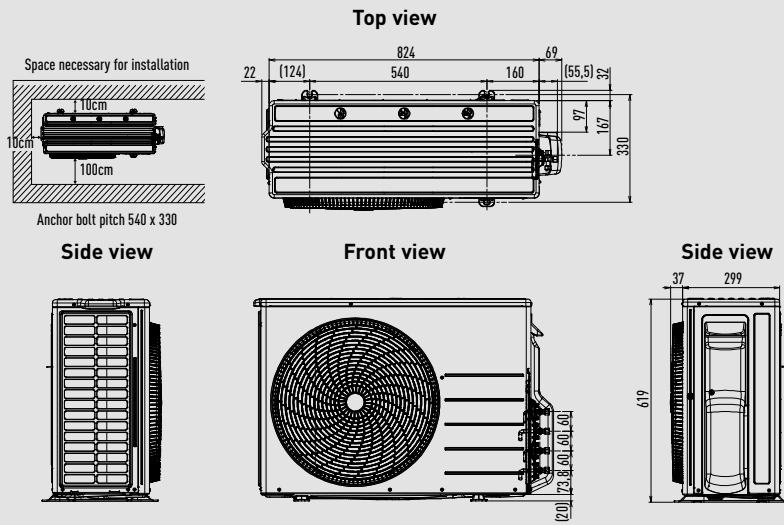

CU-3Z52TBE / CU-3Z68TBE / CU-4Z68TBE

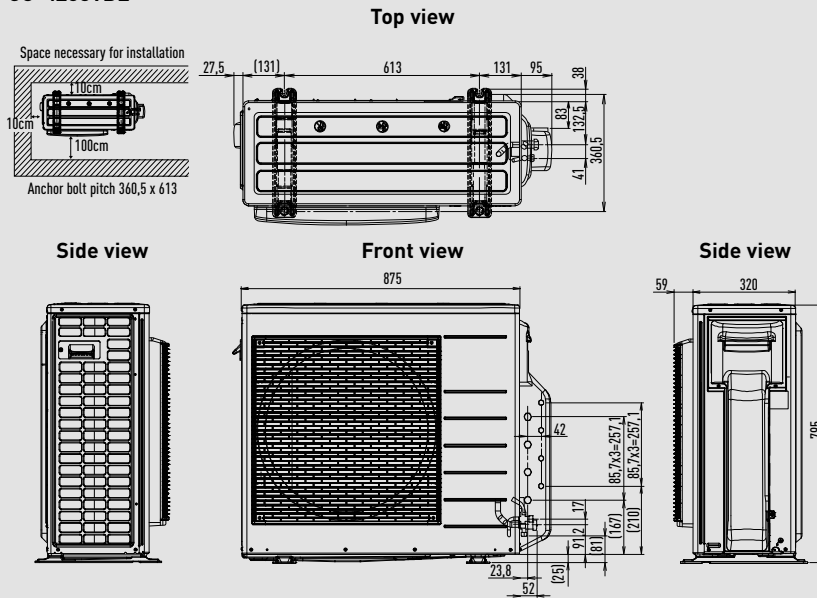

CU-4Z80TBE / CU-5Z90TBE

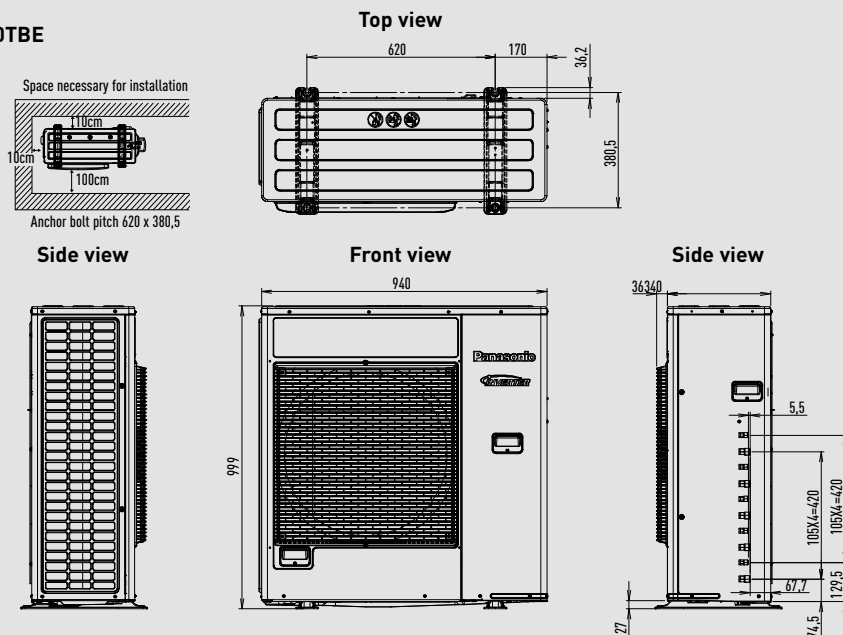

Outdoor units Multi Wall TZ.

CU-2TZ41TBE / CU-2TZ50TBE

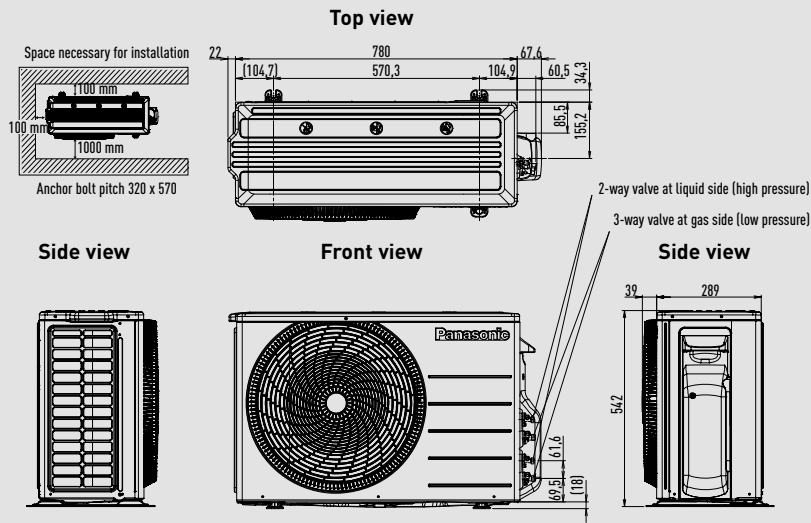

CU-3TZ52TBE

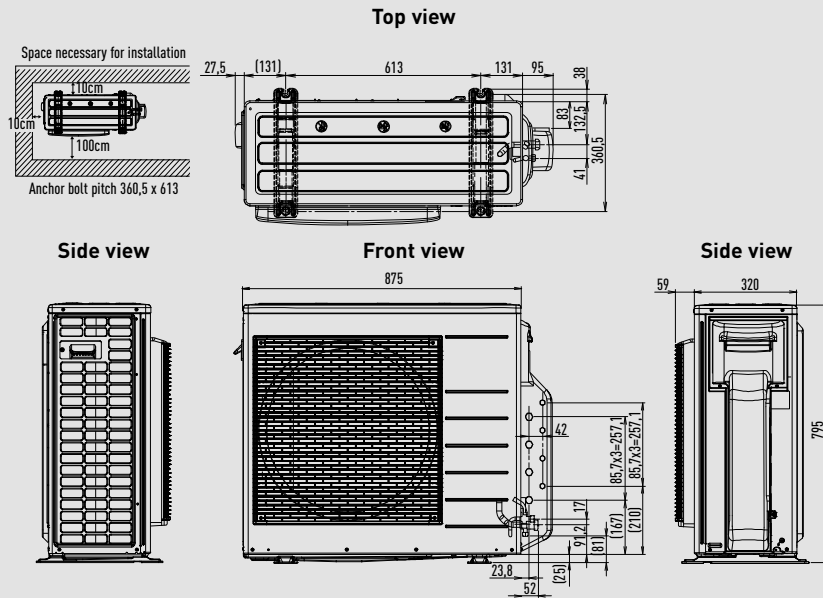

Wall-mounted Professional (from 2,5 to 4,2 kW).

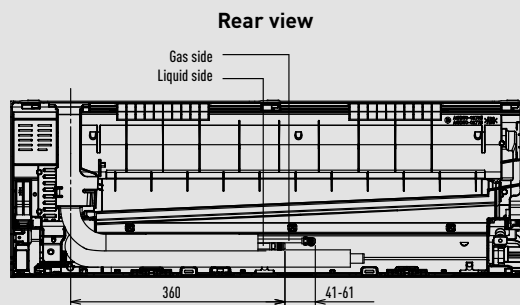
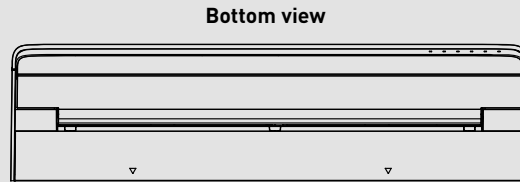
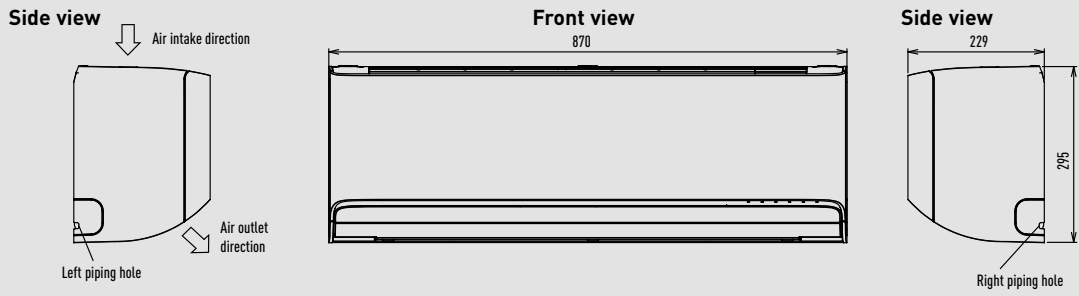

Relative position between the indoor unit and the installation plate
Front view

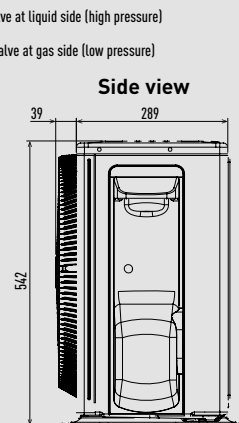
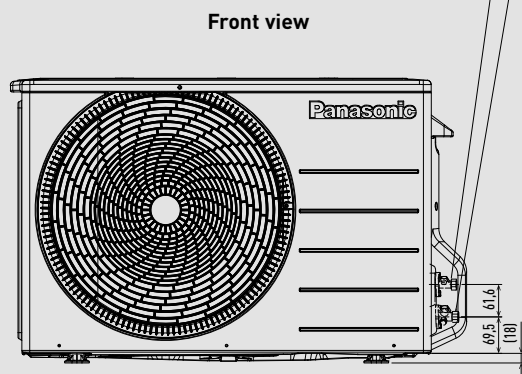
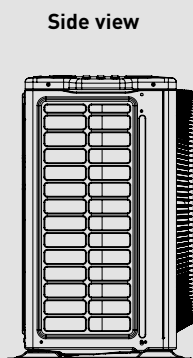
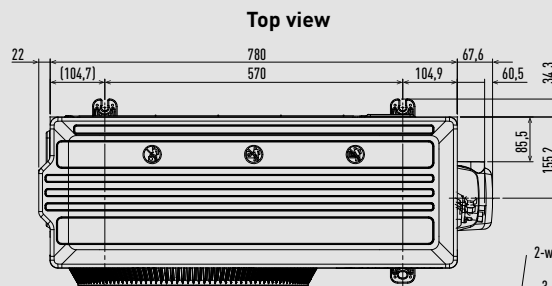
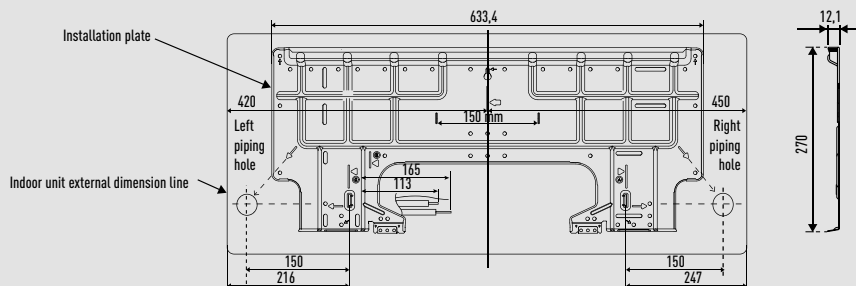

Wall-mounted Professional (5,0 and 7,1 kW).

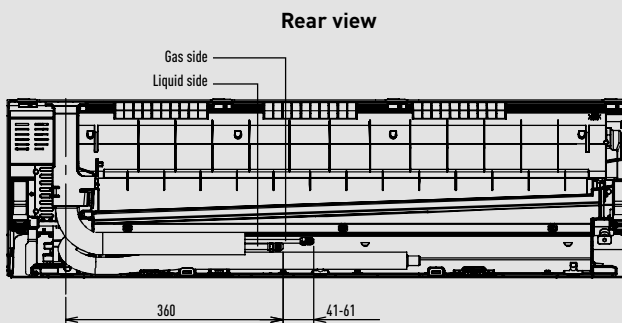
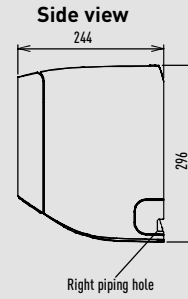
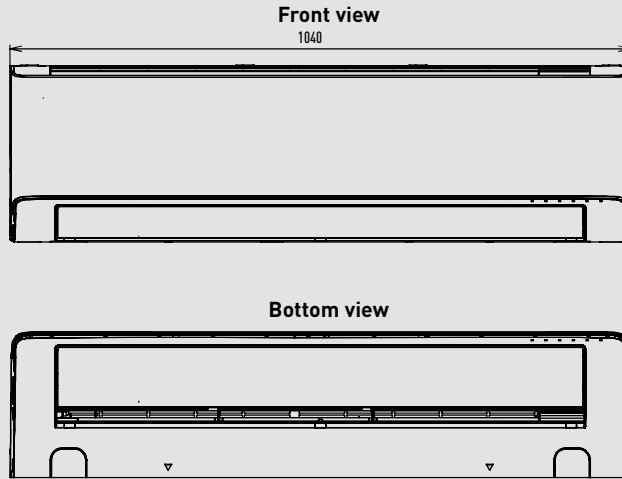
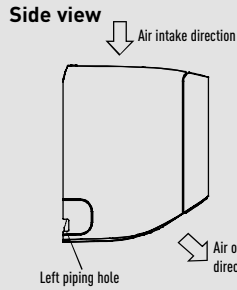

Relative position between the indoor unit and the installation plate

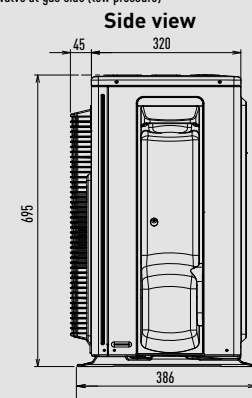
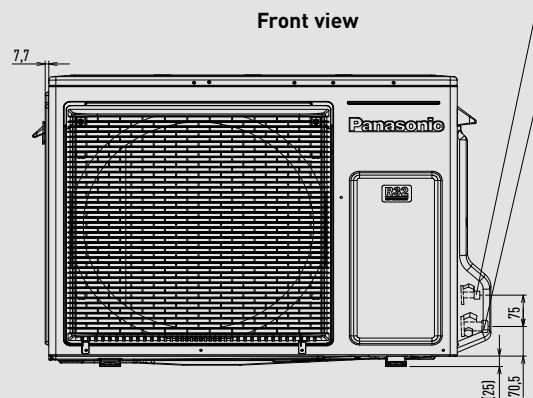
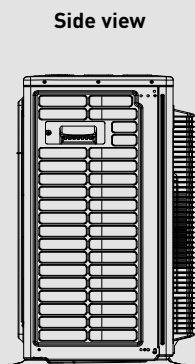
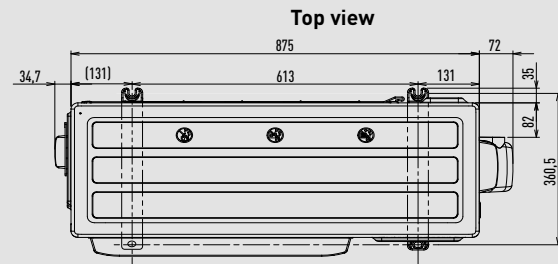
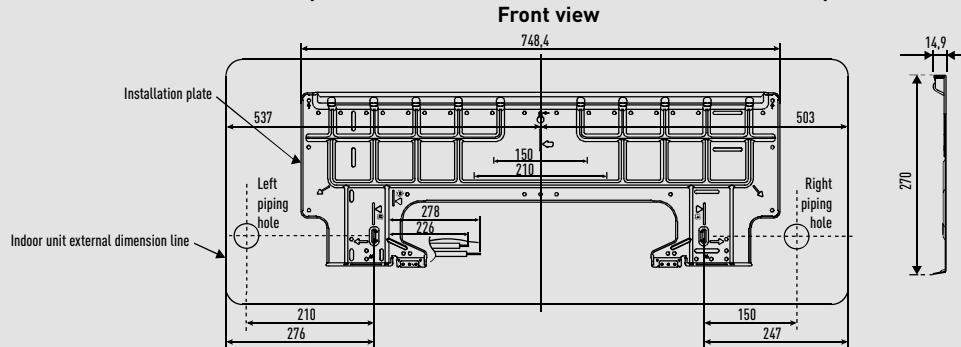

Unit: mm

PACi NX Series wall-mounted.

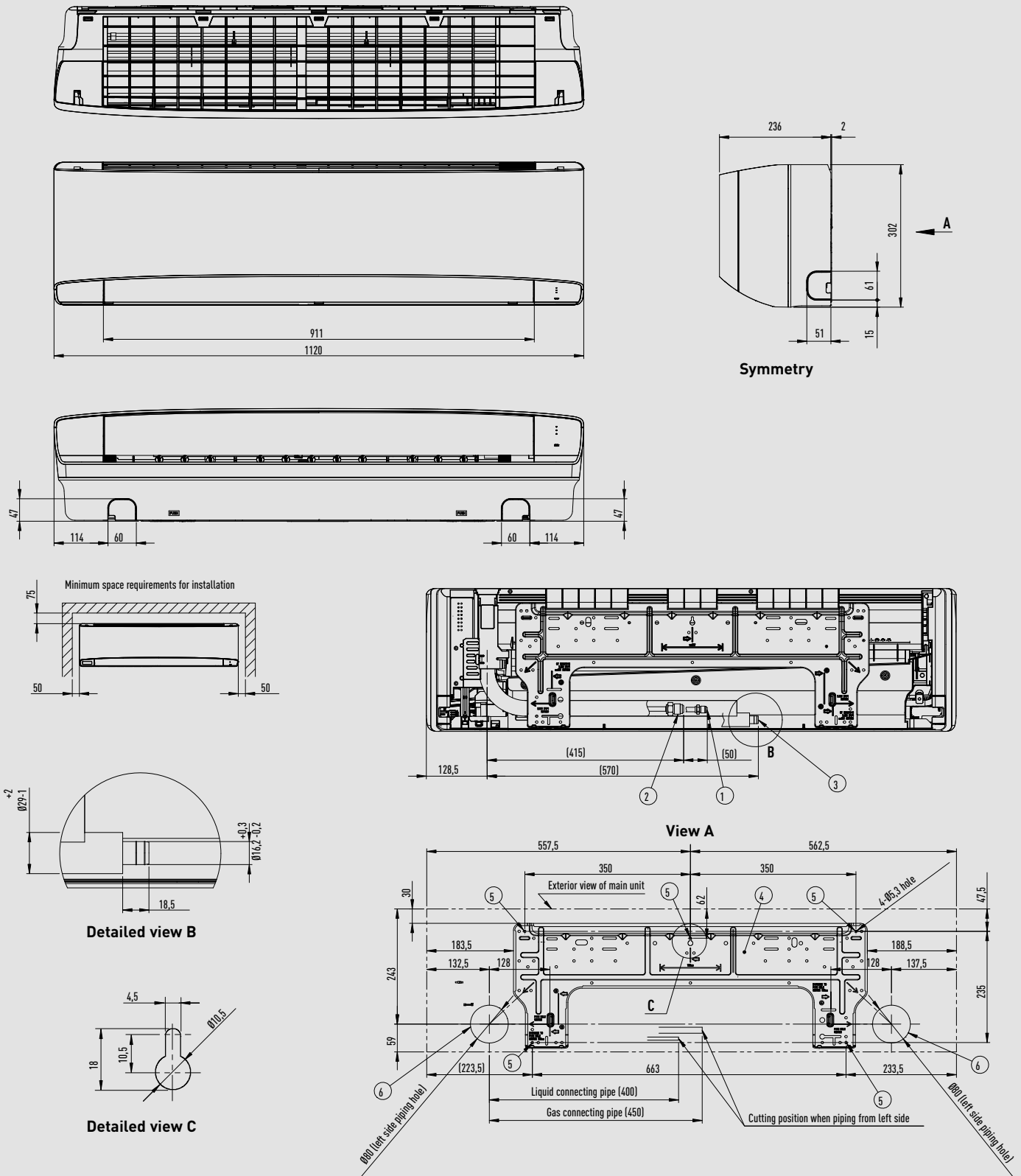

Type	S-3650PK4E	S-6010PK4E
1 Refrigerant piping (liquid)	$\varnothing 6,35$ (flared)	$\varnothing 9,52$ (flared) ¹⁾
2 Refrigerant piping (gas)	$\varnothing 12,70$ (flared)	60: $\varnothing 15,88$ (flared) ²⁾ 71: $\varnothing 15,88$ (flared) 100: $\varnothing 15,88$ (flared)
3 Drain hose		
4 Rear panel		
5 Rear panel fixing holes ($\varnothing 5,3$ holes or as shown in figure "C")		
6 Piping and wiring holes ($\varnothing 80$)		

1) When connecting with U-60PZ3E5, U-71PZ3E5 or U-60PZH3E5, connect the liquid socket pipe ($\varnothing 9,52 - \varnothing 6,35$) to the liquid pipe side indoor unit.
2) When connecting with U-60PZ3E5 or U-60PZH3E5, connect the gas socket pipe ($\varnothing 15,88 - \varnothing 12,7$) to the gas pipe side indoor unit.

PACi NX Series 4 way 60x60 cassette.

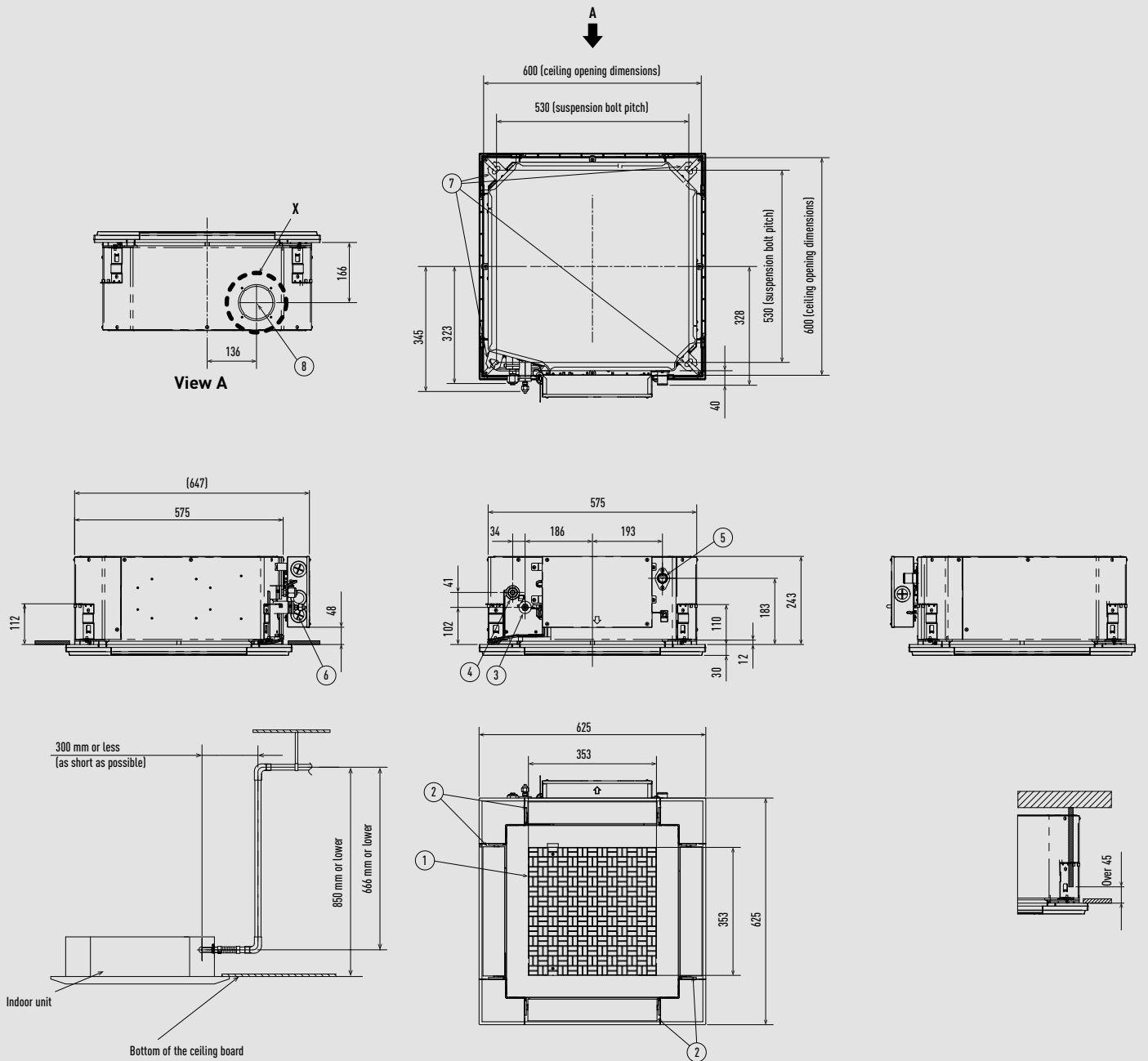

* Length of supplied drain pipe= 250 mm.

Type	25-50	60
1 Air intake		
2 Air outlet		
3 Refrigerant piping (liquid)	Ø6,35 (flared)	Ø9,52 (flared) ¹⁾
4 Refrigerant piping (gas)	Ø12,70 (flared)	Ø15,88 (flared) ²⁾
5 Drain pipe connection port VP20		
6 Power supply port		
7 Suspension bolt hole (4-11x26 slot)		
8 Fresh air intake duct connection port (Ø100) ³⁾		

1) When connecting with U-60PZ3E5A or U-60PZH3E5, connect the liquid socket pipe (Ø9,52-Ø6,35) to the liquid pipe side indoor unit.
 2) When connecting with U-60PZ3E5A or U-60PZH3E5, connect the gas socket pipe (Ø15,88-Ø12,70) to the gas pipe side indoor unit.
 3) Necessary to attach duct connecting flange (field supply).

Filter dimension: 362 x 362 x 15 mm.

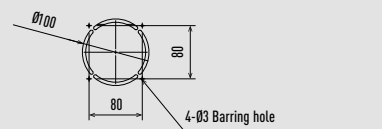

Detailed view X

PACi NX Series 4 way 90x90 cassette.

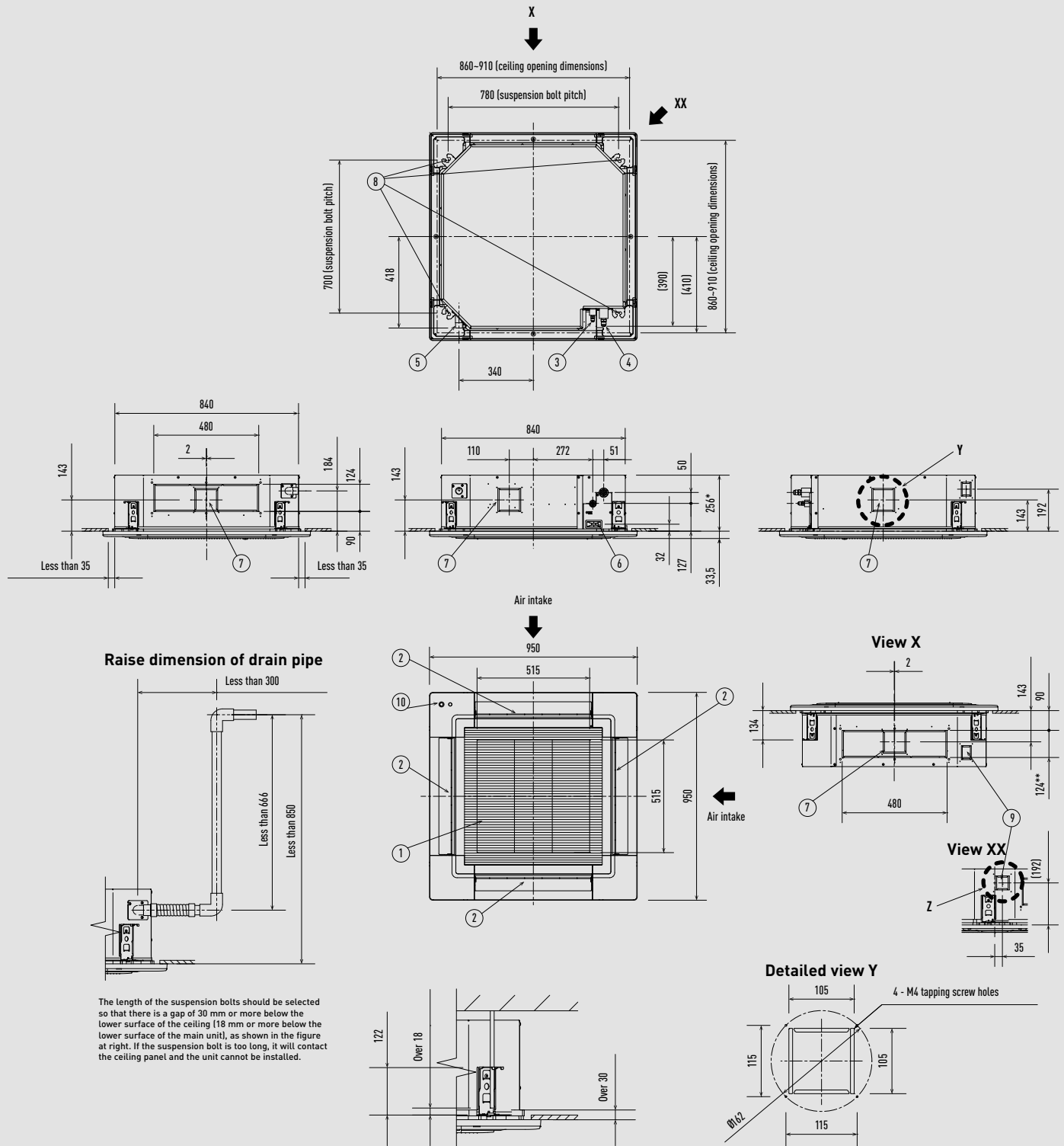

Type	S-3650PU3E	S-6071PU3E	S-1014PU3E
1 Air intake			
2 Air outlet			
3 Refrigerant piping (liquid)	Ø6,35 (flared)	Ø9,52 (flared) ¹⁾	Ø9,52 (flared)
4 Refrigerant piping (gas)	Ø12,70 (flared)	60: Ø15,88 (flared) ²⁾ 71: Ø15,88 (flared)	Ø15,88 (flared)
5 Drain pipe connection port VP25		Outer diameter Ø32	
6 Power supply port			
7 Suspension bolt hole		4-12x30 elongated hole	
8 Fresh air intake duct connection port		Ø100 ³⁾	
9 Suspension bolt hole		4-12x30 elongated hole	
10 Econavi sensor (only CZ-KPU3A or CZ-KPU3AW)			

1) When connecting with U-60PZ3E5, U-71PZ3E5 or U-60PZH3E5, connect the liquid socket pipe (Ø9,52 - Ø6,35) to the liquid pipe side indoor unit.

2) When connecting with U-60PZ3E5 or U-60PZH3E5, connect the gas socket pipe (Ø15,88 - Ø12,7) to the gas pipe side indoor unit.

3) Necessary to attach duct connecting flange (field supply).

Filter dimension: 520 x 520 x 15 mm.

* 319 mm for S-1014PU3E.

** 187 mm for S-1014PU3E.

PACi NX Series ceiling (S-3650PT3E).

Detailed view of air intake duct connection port

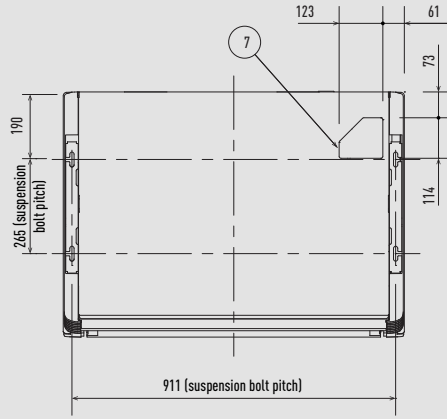
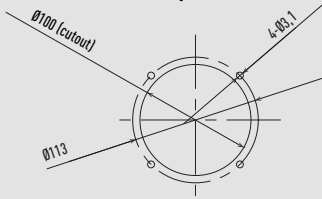

Distance of each exposed bolt must be of equal length within 50 mm.

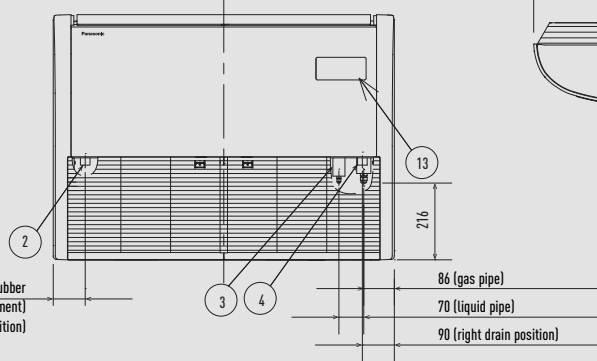
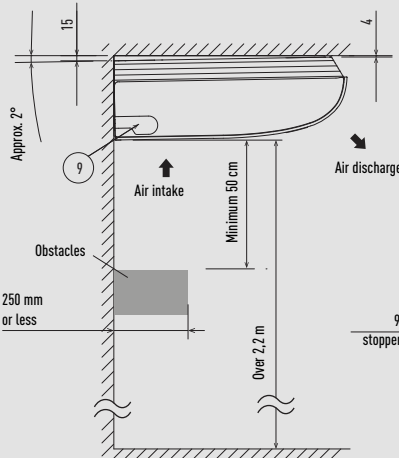
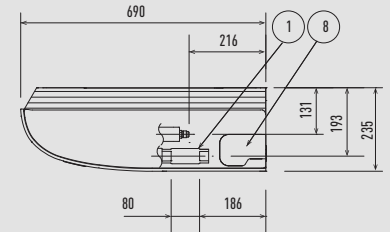
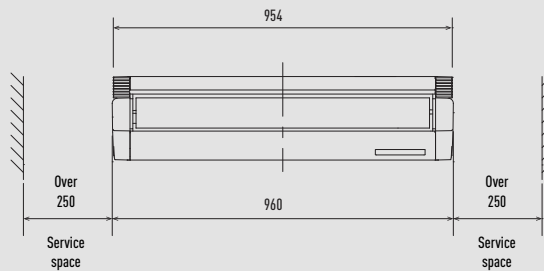
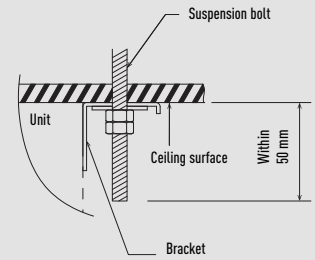

Hole position of indoor unit rear-side (figure shows view from front)

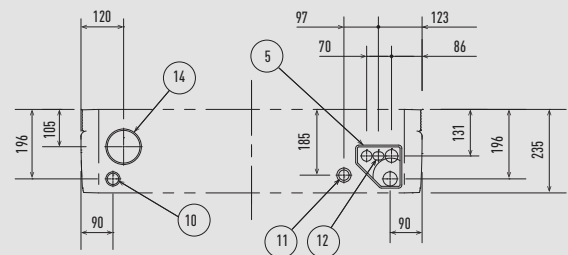

Piping hole position on wall surface (figure shows view from front)

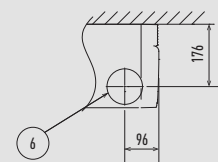

1	Drain port VP20	Inside diameter Ø26 mm, drain hose supplied
2	Left drain position	
3	Refrigerant piping (liquid)	Ø6,35mm (flared)
4	Refrigerant piping (gas)	Ø12,7mm (flared)
5	Cover of rear piping hole	
6	Piping hole on wall surface	Ø100 mm
7	Upper side piping port	
8	Right side drain hose outlet port (cutout)	
9	Left side drain hose outlet port (cutout)	
10	Left-rear side drain hose outlet port (cutout)	
11	Power inlet port	
12	Remote control wiring and inter-unit wiring inlet port	
13	Wireless remote controller receiver installation location	
14	Air intake duct connection port	Ø100 mm (cutout)

Filter dimension: 421 x 250 x 16 mm x 2 pcs.

Unit: mm

PACi NX Series ceiling (S-6071PT3E).

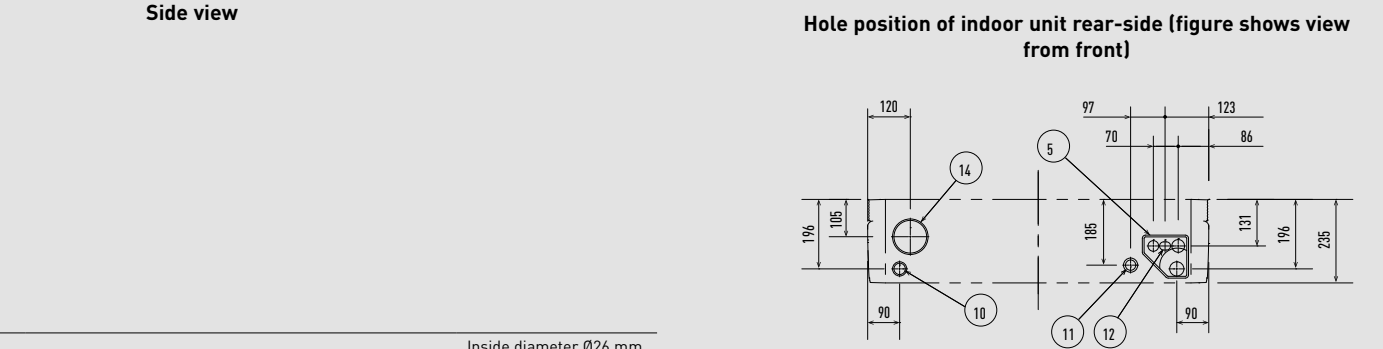
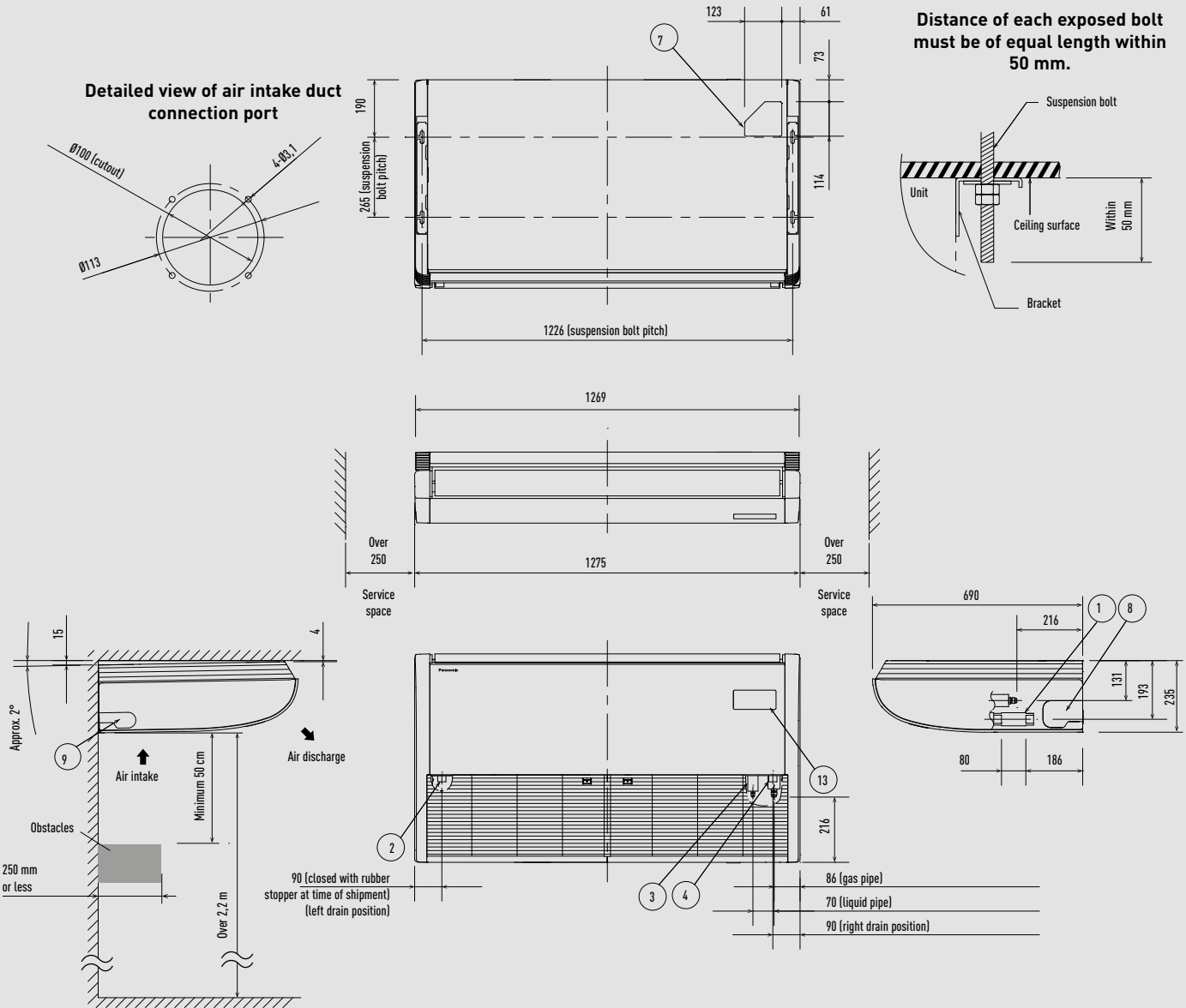

1	Drain port VP20	Inside diameter Ø26 mm, drain hose supplied
2	Left drain position	
3	Refrigerant piping (liquid)	Ø9,52 (flared) ¹⁾
4	Refrigerant piping (gas)	Ø15,88 (flared) ²⁾
5	Cover of rear piping hole	
6	Piping hole on wall surface	Ø100 mm
7	Upper side piping port	
8	Right side drain hose outlet port (cutout)	
9	Left side drain hose outlet port (cutout)	
10	Left-rear side drain hose outlet port (cutout)	
11	Power inlet port	
12	Remote control wiring and inter-unit wiring inlet port	
13	Wireless remote controller receiver installation location	
14	Air intake duct connection port	Ø100 mm (cutout)

1) When connecting with U-60PZ3E5, U-71PZ3E5 or U-60PZH3E5, connect the liquid socket pipe (Ø9,52 - Ø6,35) to the liquid pipe side indoor unit.
 2) When connecting with U-60PZ3E5 or U-60PZH3E5, connect the gas socket pipe (Ø15,88 - Ø12,7) to the gas pipe side indoor unit.

Filter dimension: 579 x 250 x 16 mm x 2 pcs.

Piping hole position on wall surface (figure shows view from front)

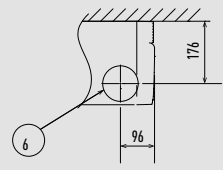

Unit: mm

PACi NX Series ceiling (S-1014PT3E).

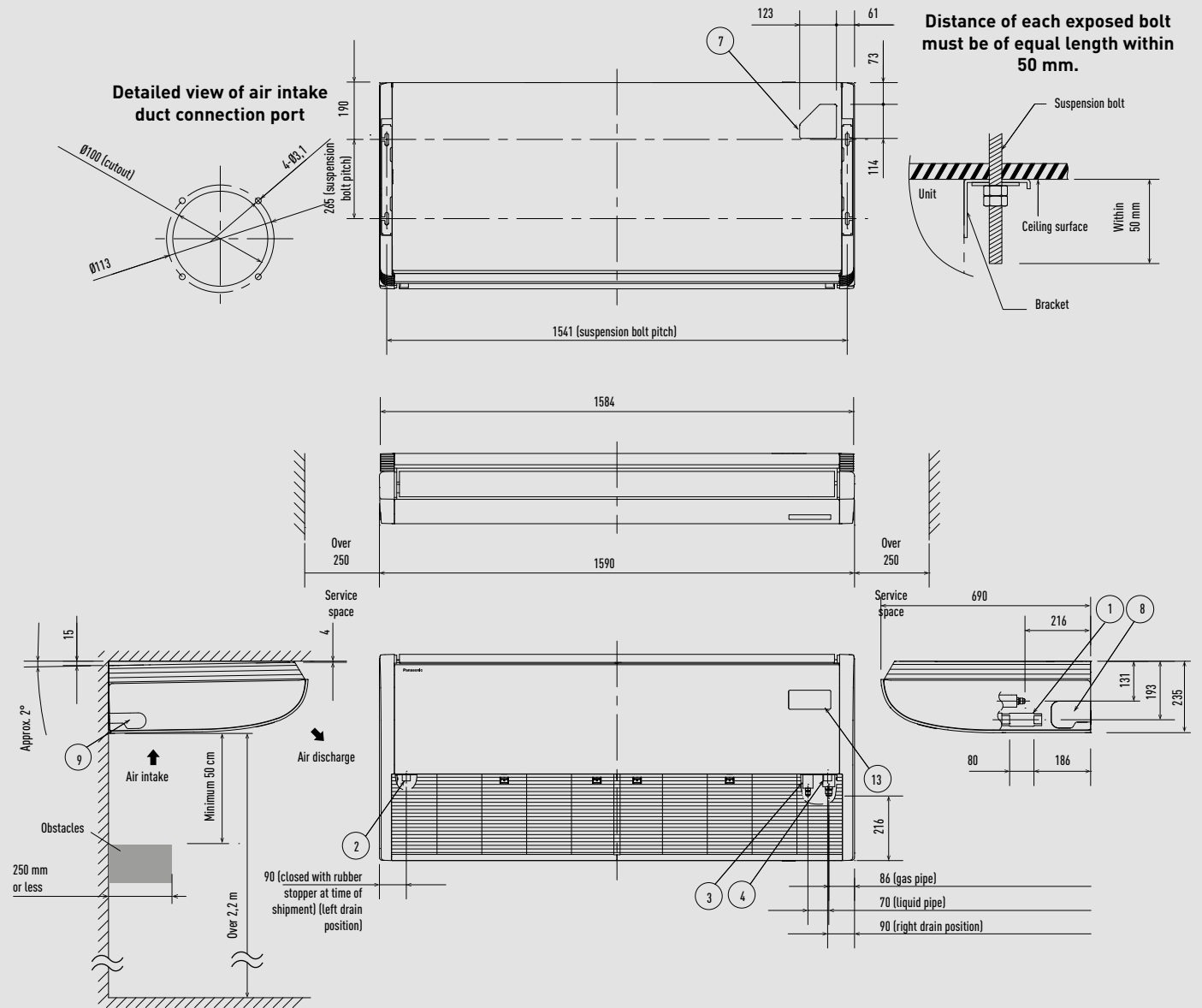

Hole position of indoor unit rear-side (figure shows view from front)

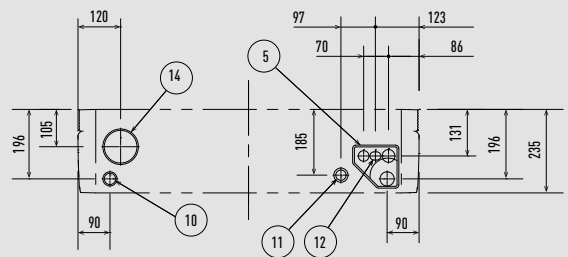

Piping hole position on wall surface (figure shows view from front)

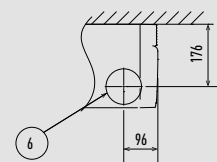

1	Drain port VP20	Inside diameter Ø26 mm, drain hose supplied
2	Left drain position	
3	Refrigerant piping (liquid)	Ø9,52 (flared)
4	Refrigerant piping (gas)	Ø15,88 (flared)
5	Cover of rear piping hole	
6	Piping hole on wall surface	Ø100 mm
7	Upper side piping port	
8	Right side drain hose outlet port (cutout)	
9	Left side drain hose outlet port (cutout)	
10	Left-rear side drain hose outlet port (cutout)	
11	Power inlet port	
12	Remote control wiring and inter-unit wiring inlet port	
13	Wireless remote controller receiver installation location	
14	Air intake duct connection port	Ø100 mm (cutout)

Filter dimension: 736 x 250 x 16 mm x 2 pcs.

Unit: mm

PACi NX Series adaptive ducted unit.

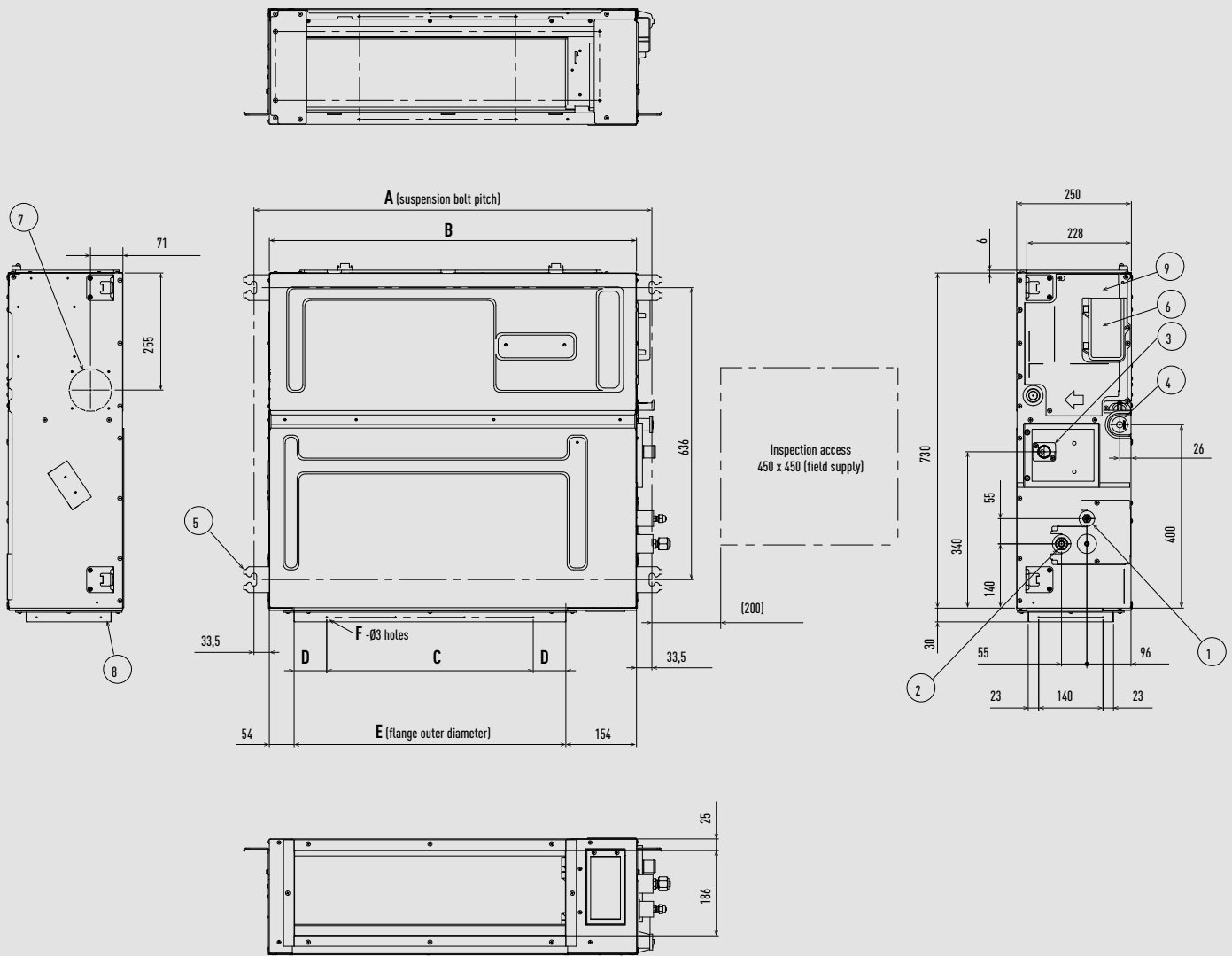

Type	A	B	C	D	E	F
	mm	mm	mm	mm	mm	Q'ty
S-3650PF3E	867	800	450 [pitch 150 x 3]	71	592	12
S-6071PF3E	1067	1000	750 [pitch 150 x 5]	21	792	16
S-1014PF3E	1467	1400	1050 [pitch 150 x 7]	71	1192	20

Type	S-3650PF3E	S-6071PF3E	S-1014PF3E
1 Refrigerant piping (liquid)	Ø6,35 (flared)	Ø9,52 (flared) ¹⁾	Ø9,52 (flared)
2 Refrigerant piping (gas)	Ø12,70 (flared)	60: Ø15,88 (flared) ²⁾ 71: Ø15,88 (flared)	Ø15,88 (flared)
3 Upper drain port VP20	Ø26 (200 mm flexible hose supplied)		
4 Suspension lug	4-12x30		
5 Power supply port			
6 Bottom drain port VP20	Ø26 mm		
7 Fresh air intake duct connection port	Ø100 ³⁾		
8 Flange for flexible air outlet duct			
9 Electrical component box			

1) When connecting with U-60PZ3E5, U-71PZ3E5 or U-60PZH3E5, connect the liquid socket pipe (Ø9,52 - Ø6,35) to the liquid pipe side indoor unit.
 2) When connecting with U-60PZ3E5 or U-60PZH3E5, connect the gas socket pipe (Ø15,88 - Ø12,7) to the gas pipe side indoor unit.
 3) Necessary to attach duct connecting flange (field supply).

Filter dimension: 520 x 520 x 15 mm.

Big PACi high static pressure hide-away 20,0-25,0 kW.

	S-200PE3E5B	S-250PE3E5B
1	Refrigerant piping (liquid) Connection piping Ø12,70 > Ø9,52	Ø12,70 (flared)
2	Refrigerant piping (gas) Connection piping Ø19,05 > Ø25,40	Ø19,05 (brazed)
3	Power supply port	
4	Communication port	
5	Drain port VP25	
6	Flange for air intake duct	
7	Flange for the air outlet duct	

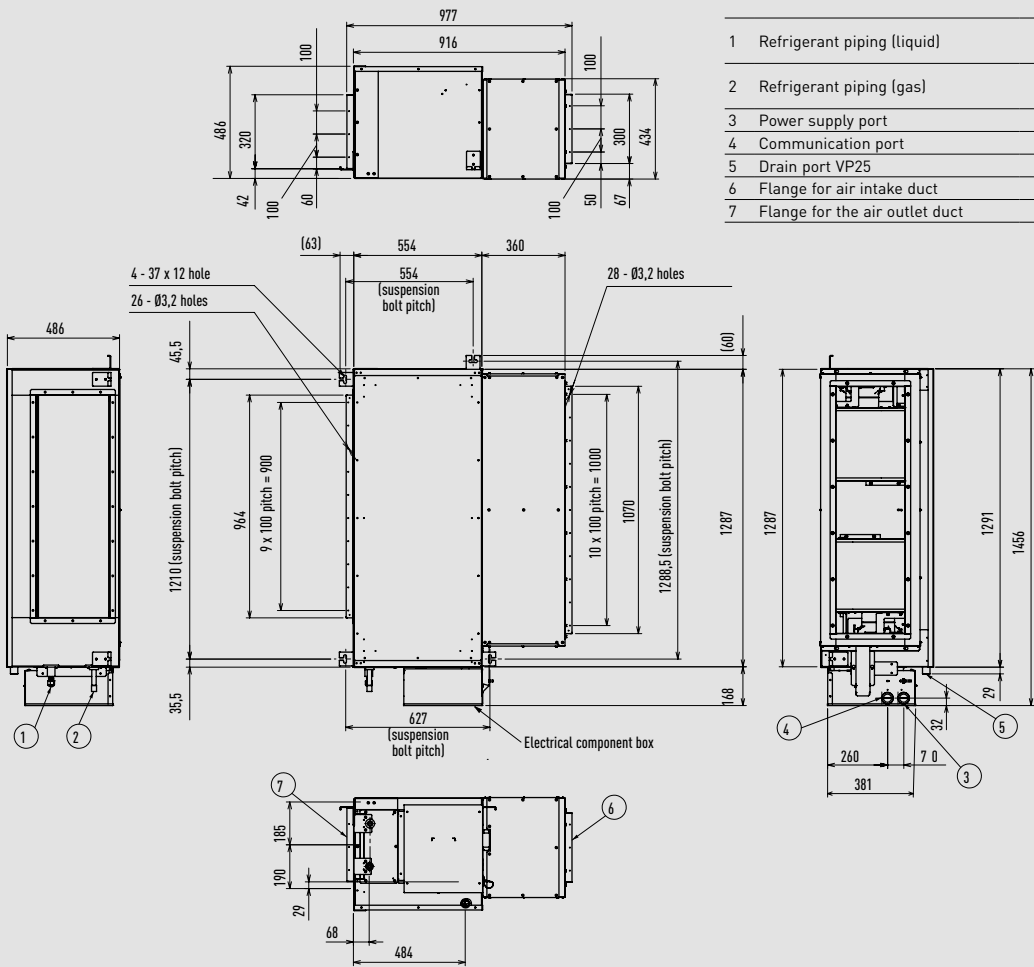

Dimensions of suspension bolt pitch and unit.
Required Minimum Space for Installation and Service

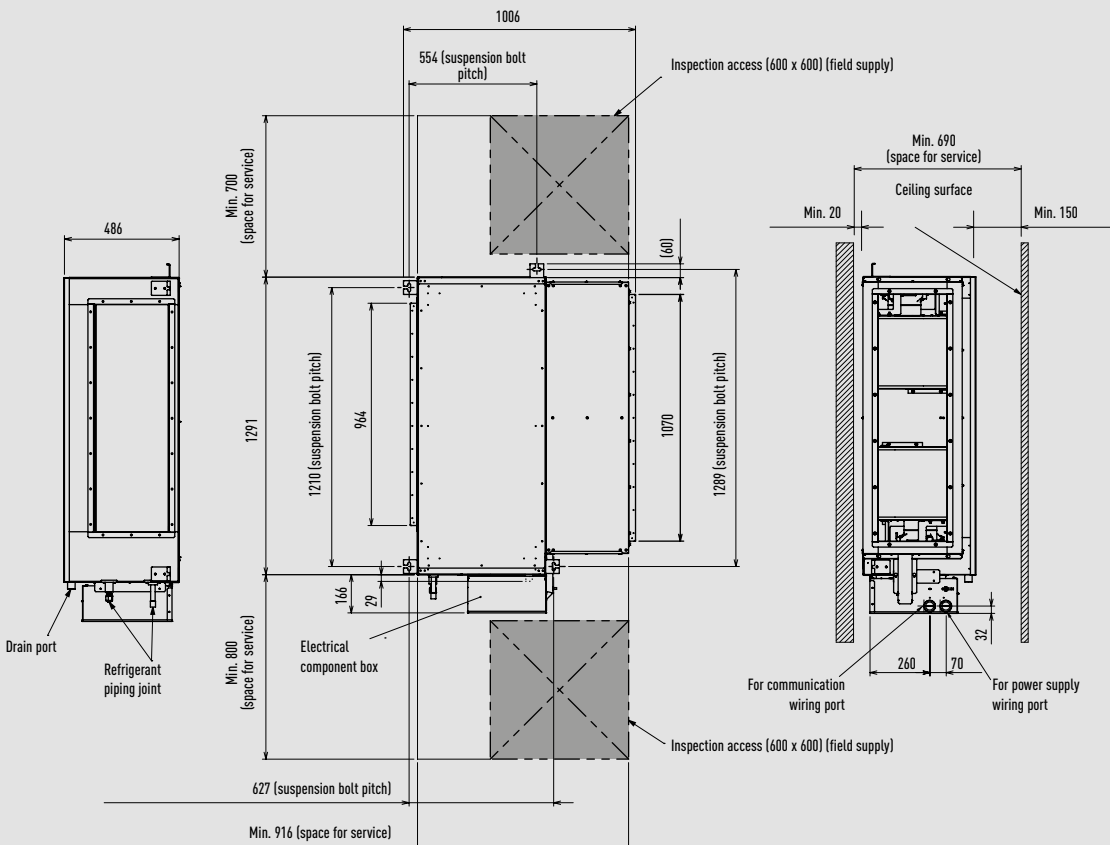

Unit: mm

PACi NX Series Elite outdoor units from 3,6 to 6,0 kW and Standard 6,0 and 7,1 kW.

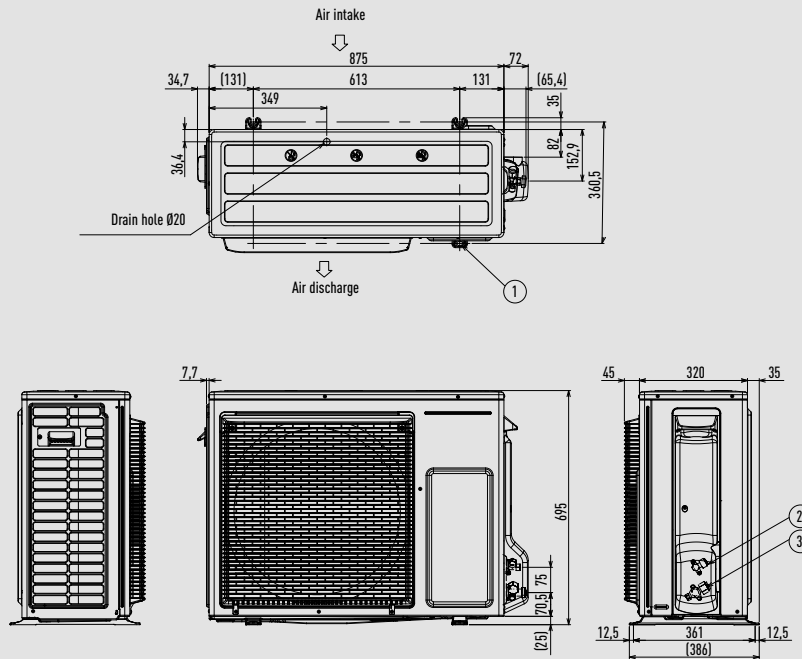

- 1 Mounting hole [4-R6,5], anchor bolt: M10
- 2 Refrigerant piping (liquid), Ø6,35 (flared)
- 3 Refrigerant piping (gas), Ø12,70 (flared). U-71PZ3E5, Ø15,88 (flared)

Unit: mm

PACi NX Series Elite outdoor units 7,1 kW to 14,0 kW.

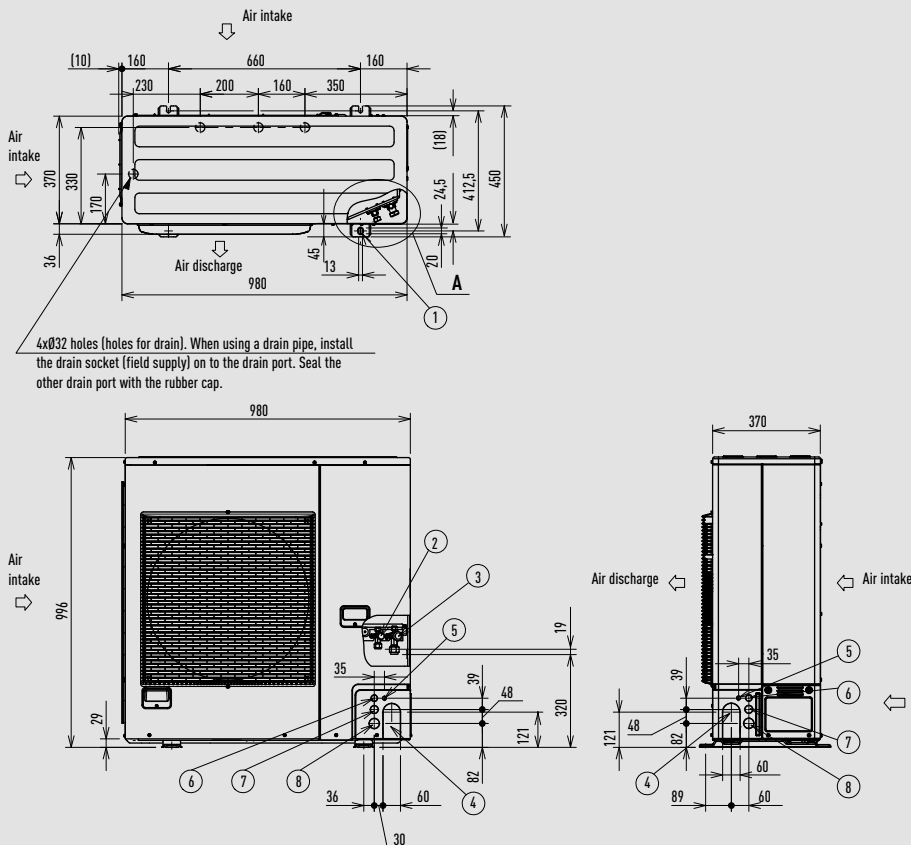

4xØ32 holes (holes for drain). When using a drain pipe, install the drain socket (field supply) on to the drain port. Seal the other drain port with the rubber cap.

- 1 Mounting hole, anchor bolt: M10
- 2 Refrigerant piping (liquid), Ø9,52 (flared)
- 3 Refrigerant piping (gas), Ø15,88 (flared)
- 4 Refrigerant piping hole
- 5 Electrical wiring port (Ø13)
- 6 Electrical wiring port (Ø22)
- 7 Electrical wiring port (Ø27)
- 8 Electrical wiring port (Ø35)

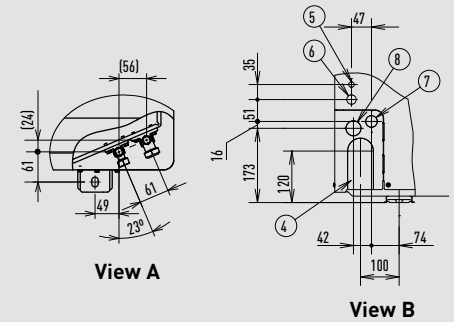

Unit: mm

PACi NX Series Standard outdoor units 2,5 and 5,0 kW.

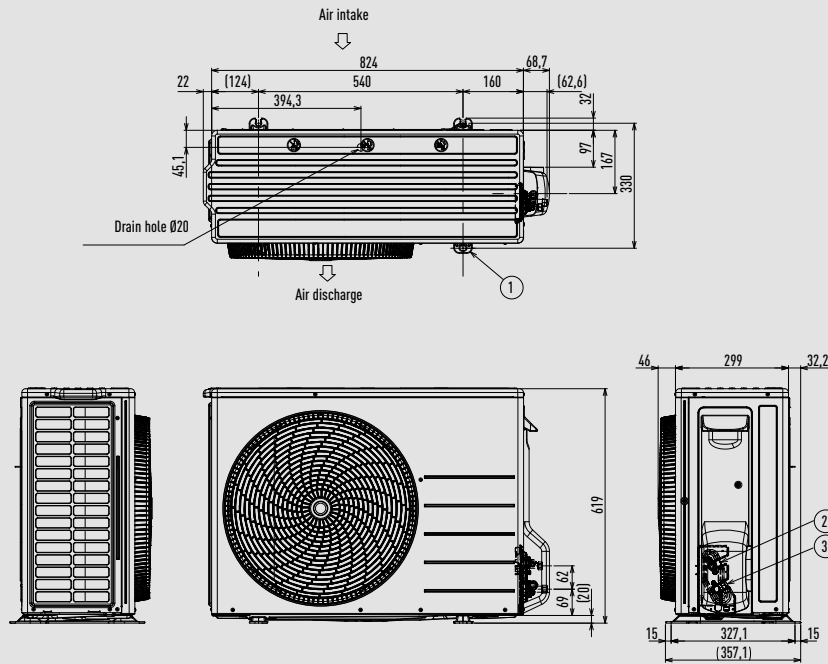

- 1 Mounting hole (4-R6,5), anchor bolt: M10
- 2 Refrigerant piping (liquid), Ø6,35 (flared)
- 3 Refrigerant piping (gas), Ø12,70 (flared)

Unit: mm

PACi NX Series Standard outdoor units from 10,0 to 14,0 kW.

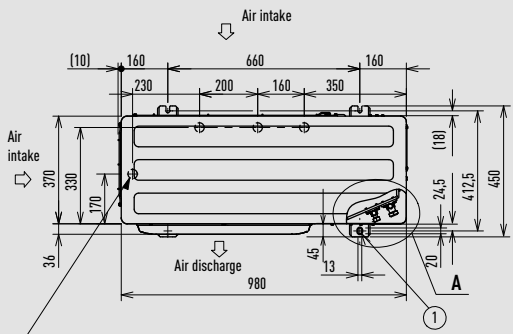

- 1 Mounting hole, anchor bolt: M10
- 2 Refrigerant piping (liquid), Ø9,52 (flared)
- 3 Refrigerant piping (gas), Ø15,88 (flared)
- 4 Refrigerant piping hole
- 5 Electrical wiring port (Ø13)
- 6 Electrical wiring port (Ø22)
- 7 Electrical wiring port (Ø27)
- 8 Electrical wiring port (Ø35)

4xØ32 holes (holes for drain). When using a drain pipe, install the drain socket (field supply) on to the drain port. Seal the other drain port with the rubber cap.



Unit: mm

Big PACi outdoor units 20,0-25,0 kW.

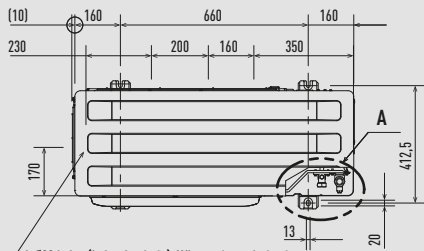

4xØ32 holes (holes for drain). When using a drain pipe, install the drain socket (field supply) on to the drain port. Seal the other drain port with the rubber cap.

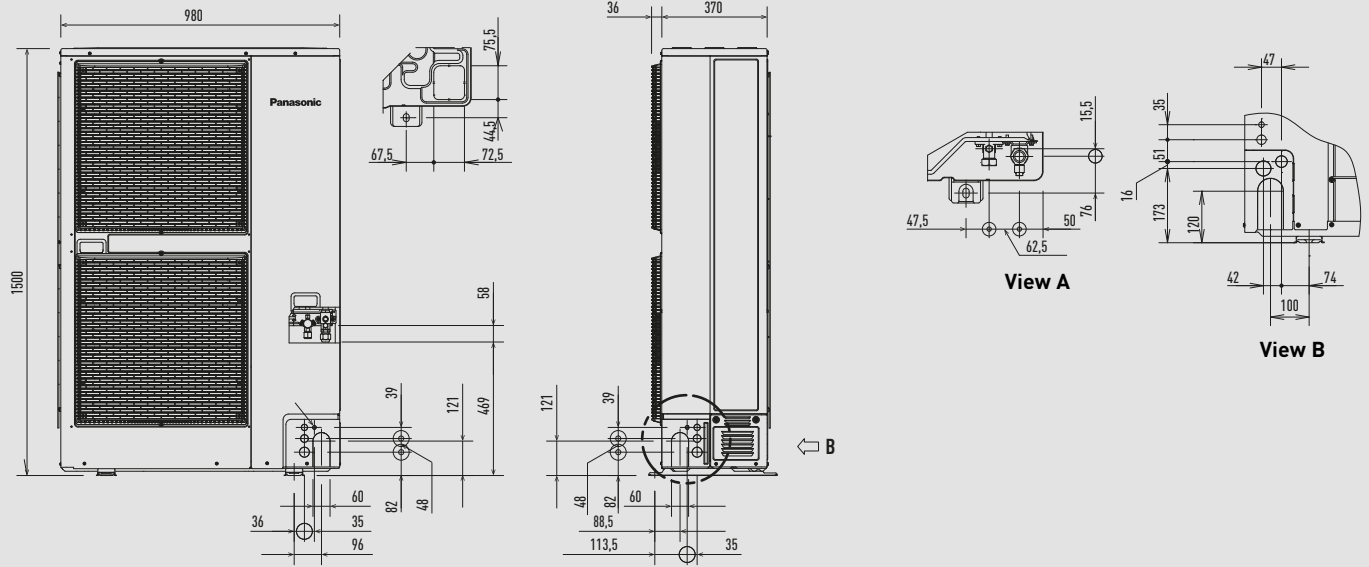

Unit: mm

PACi PRO-HT Tank.

PAW-VP750LDHW-1

PAW-VP1000LDHW-1

PAW-VP380L

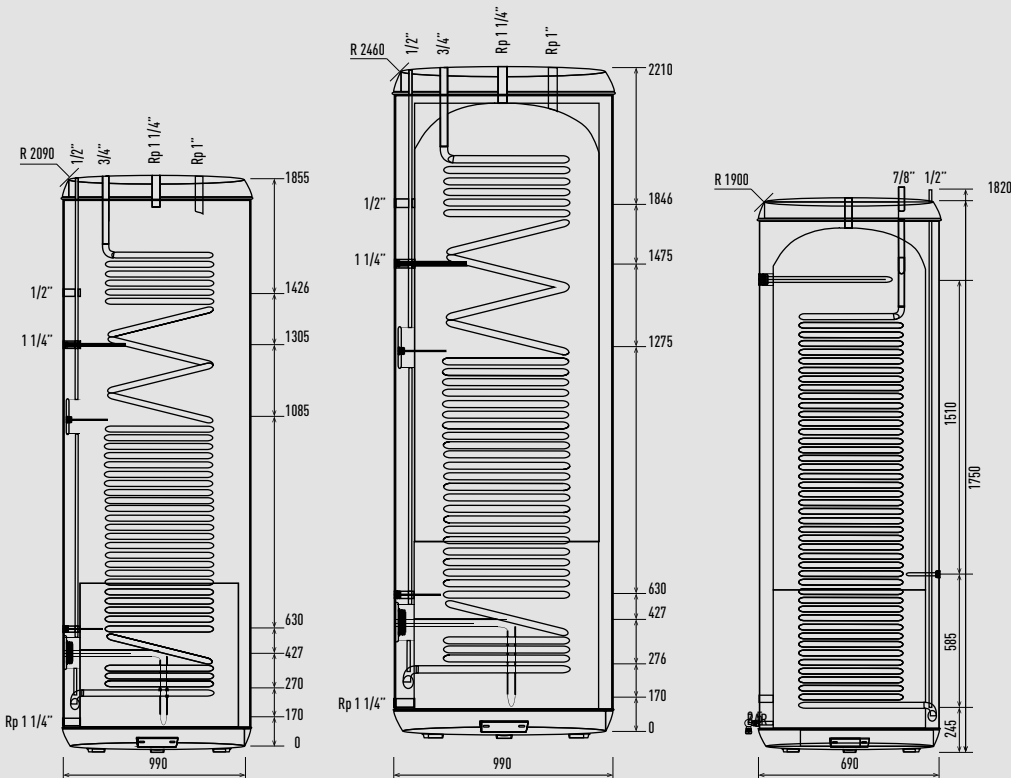

Note: R value indicates maximum overturning height.

Unit: mm

PACi Water Heat Exchanger.

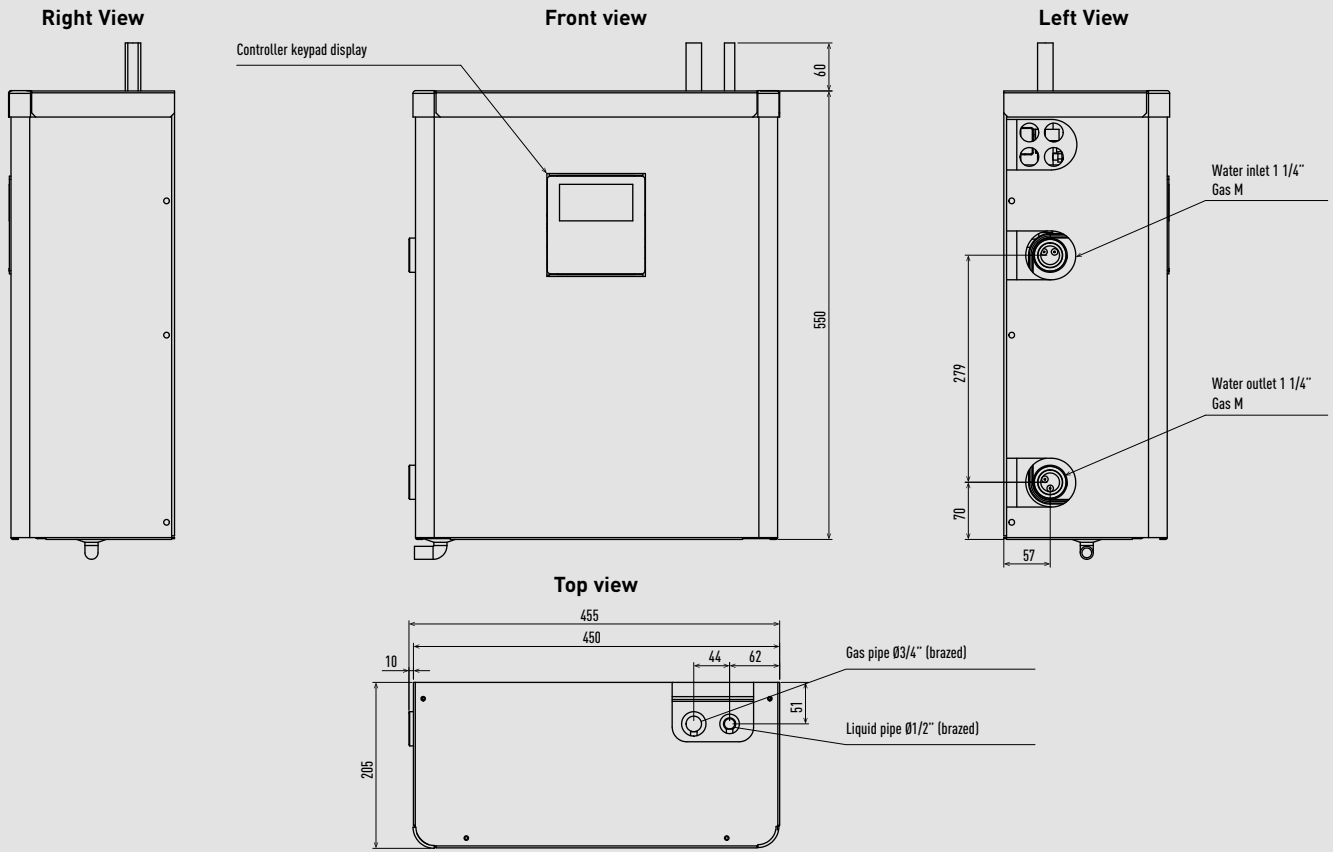

Unit: mm

Mini ECOi LZ2 Series 4 to 6 HP.

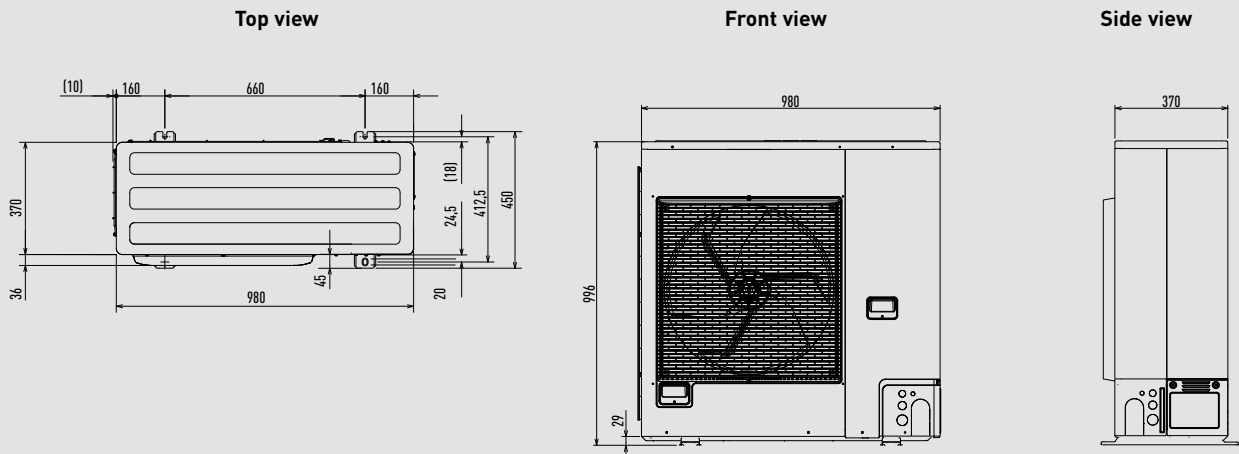

Unit: mm

Mini ECOi LZ2 Series 8 and 10 HP.

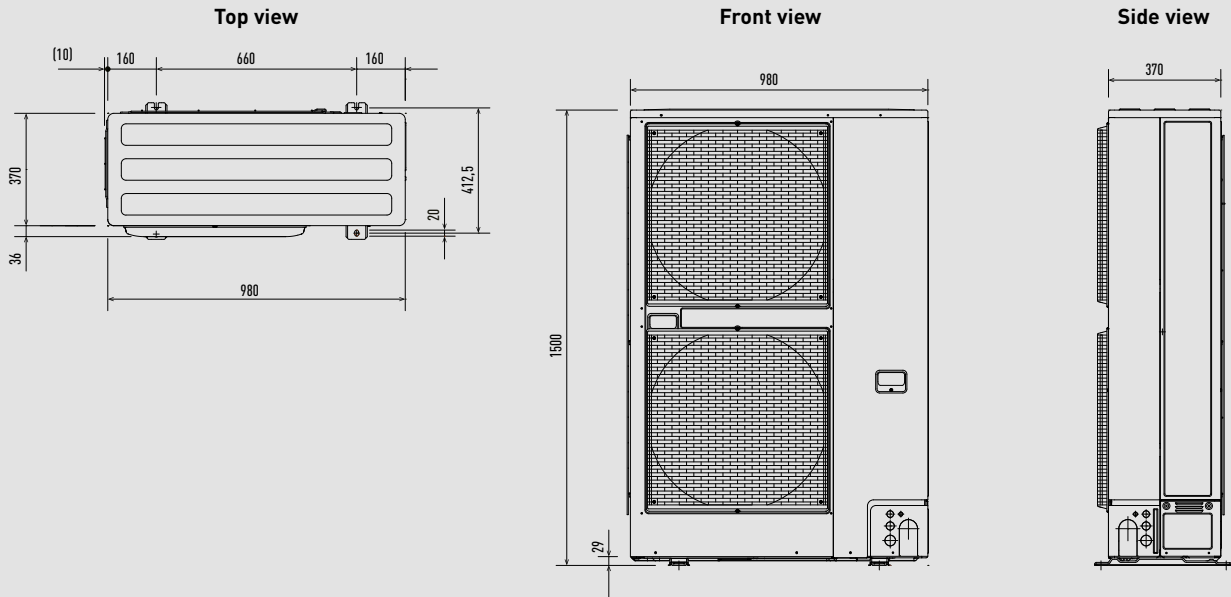

Unit: mm

Mini ECOi LE2 Series 4 to 6 HP.

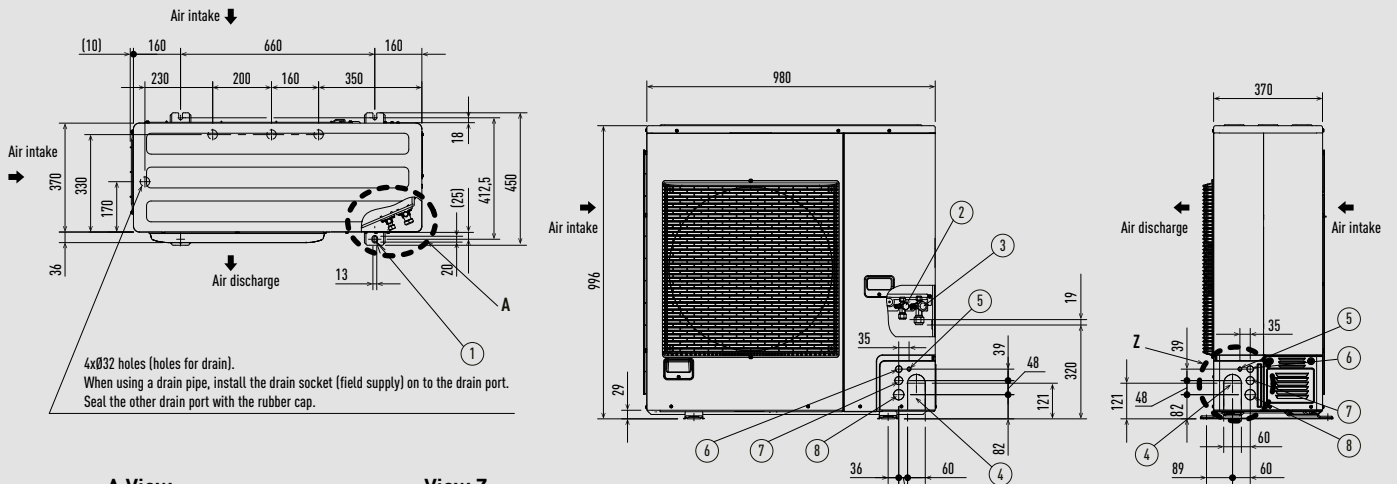

4xØ32 holes (holes for drain).
When using a drain pipe, install the drain socket (field supply) on to the drain port.
Seal the other drain port with the rubber cap.

A View

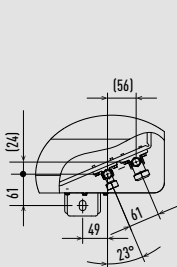

View Z

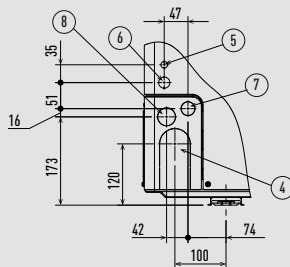

- 1 Mounting hole (4-R6,5), anchor bolt: M10
- 2 Refrigerant piping (liquid), Ø9,52 (flared)
- 3 Refrigerant piping (gas), Ø19,05 (flared)
- 4 Refrigerant piping port
- 5 Electrical wiring port (Ø13)
- 6 Electrical wiring port (Ø22)
- 7 Electrical wiring port (Ø27)
- 8 Electrical wiring port (Ø35)

Unit: mm

Mini ECOi LE1 Series 8 and 10 HP.

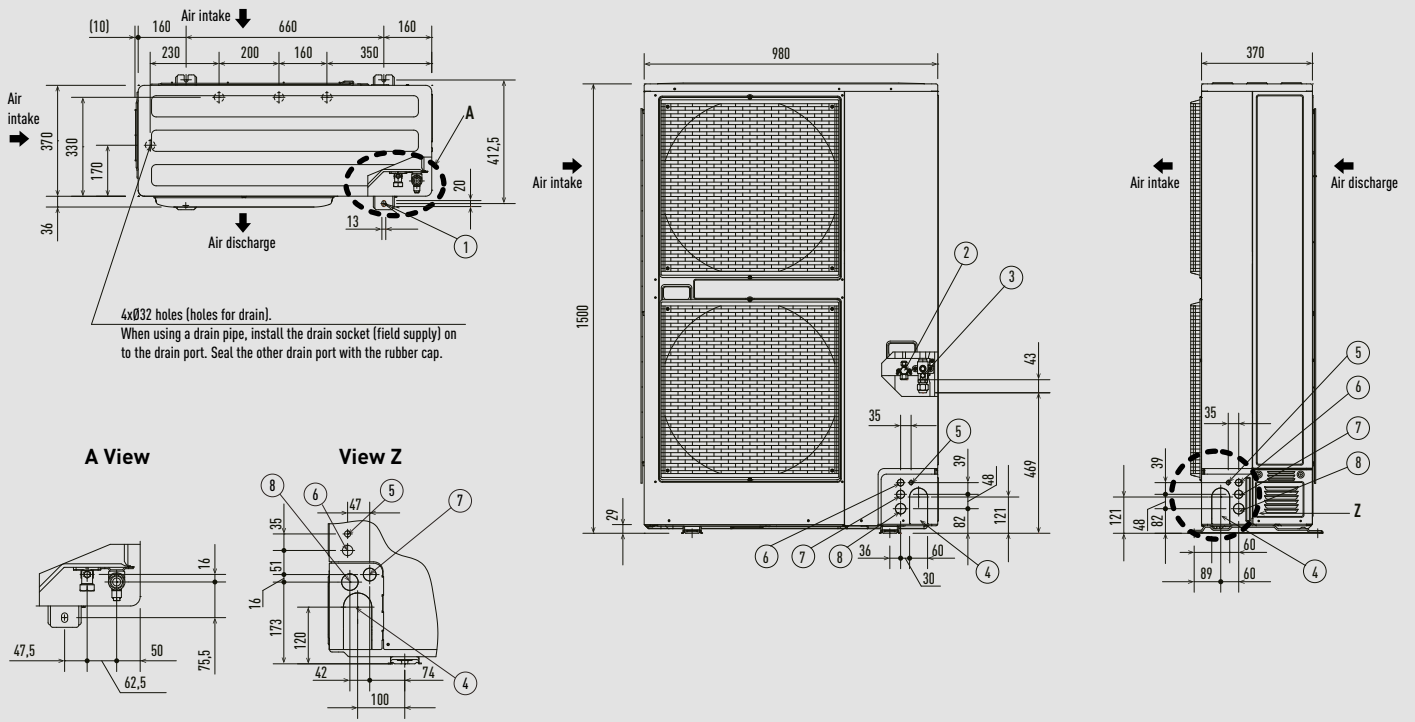

4xØ32 holes (holes for drain).
When using a drain pipe, install the drain socket (field supply) on to the drain port. Seal the other drain port with the rubber cap.

- | | |
|---|--------------------------------|
| 1 Mounting hole [4-R6,5], anchor bolt: M10 | 5 Electrical wiring port (Ø13) |
| 2 Refrigerant piping (liquid), Ø9,52 (flared) | 6 Electrical wiring port (Ø22) |
| 3 Refrigerant piping (gas), Ø19,05 (flared) | 7 Electrical wiring port (Ø27) |
| 4 Refrigerant piping port | 8 Electrical wiring port (Ø35) |

The piping of the gas main has a diameter of Ø22,22, but the connection to the service valve of the outdoor unit has a diameter of Ø19,05, so a flare has to be used. Consequently, be sure to use the enclosed joint pipe B and joint pipe A in making connections (brazed).

Unit: mm

2-Pipe ECOi EX ME2 Series 8 and 10 HP.

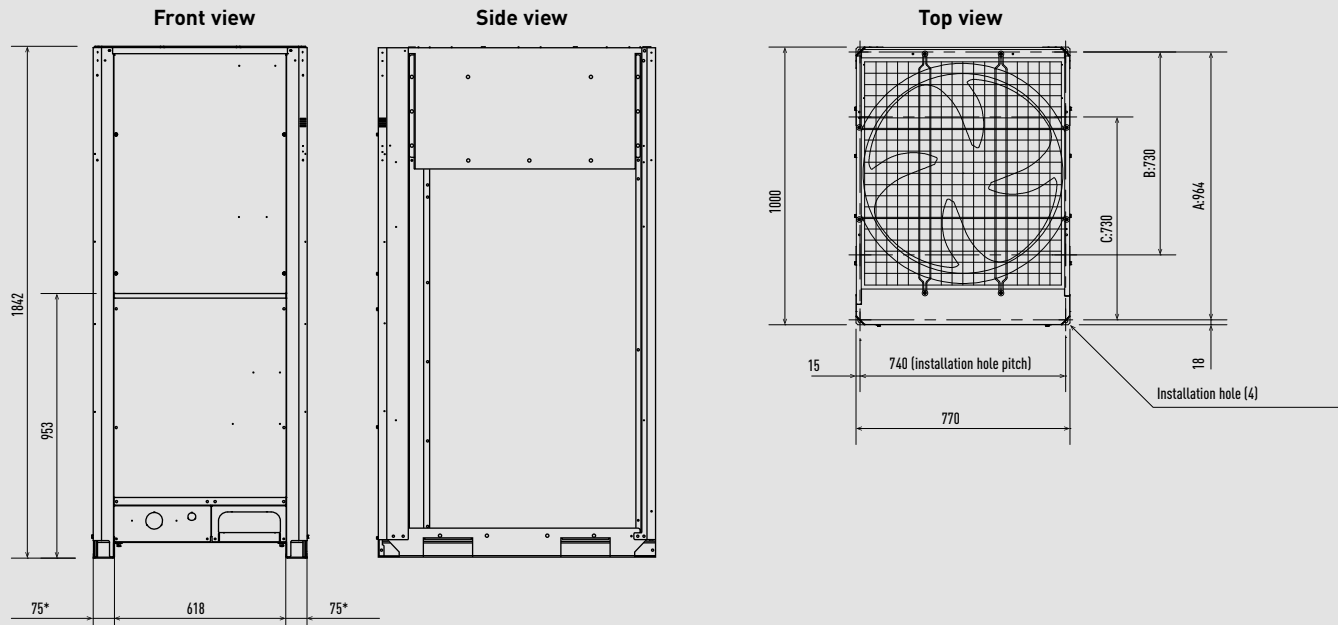

According to the installation site, you may choose the setting position in the depth direction of the anchor bolt from A, B or C.

A: 964 (installation hole pitch). The piping is routed out from the front.
B: 730 (installation hole pitch)*. The piping is routed out from the bottom.
C: 730 (installation hole pitch).

* Installation fixing bracket. Installation side.

Unit: mm

2-Pipe ECOi EX ME2 Series 12, 14 and 16 HP / 3-Pipe ECOi EX MF3 Series.

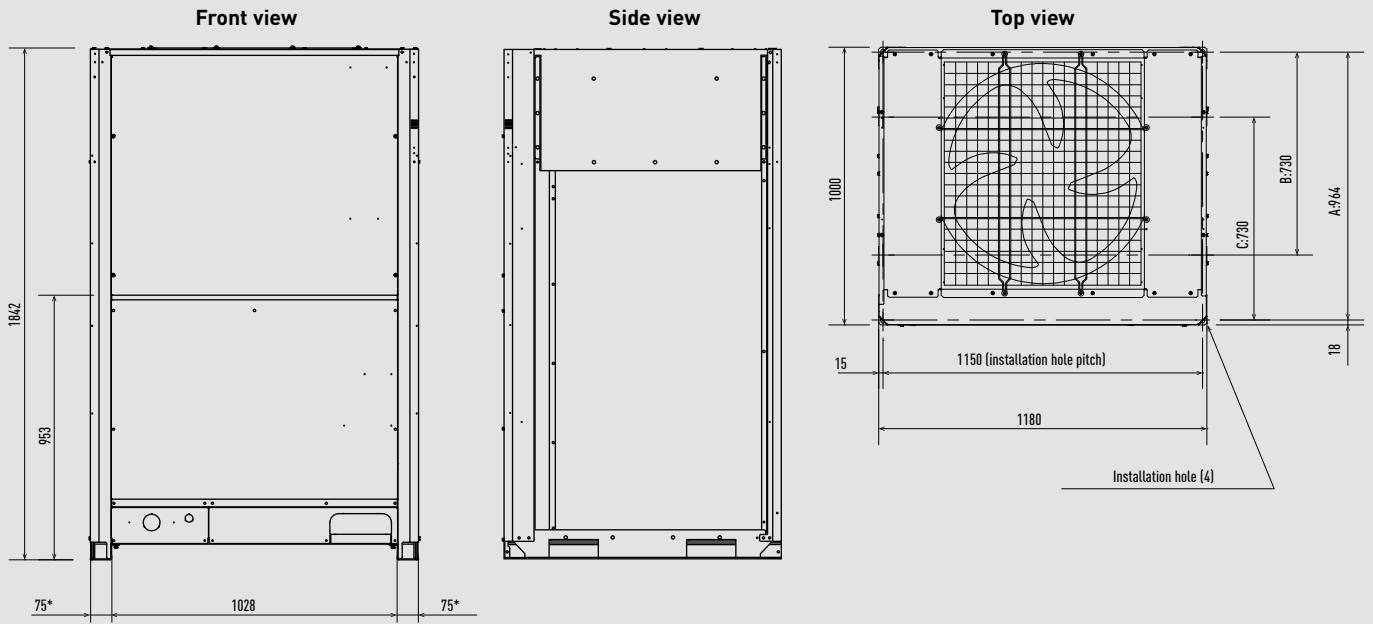

According to the installation site, you may choose the setting position in the depth direction of the anchor bolt from A, B or C.

- A: 964 (installation hole pitch). The piping is routed out from the front.
- B: 730 (installation hole pitch)*. The piping is routed out from the bottom.
- C: 730 (installation hole pitch).

* Installation fixing bracket. Installation side.

Unit: mm

2-Pipe ECOi EX ME2 Series 18 and 20 HP.

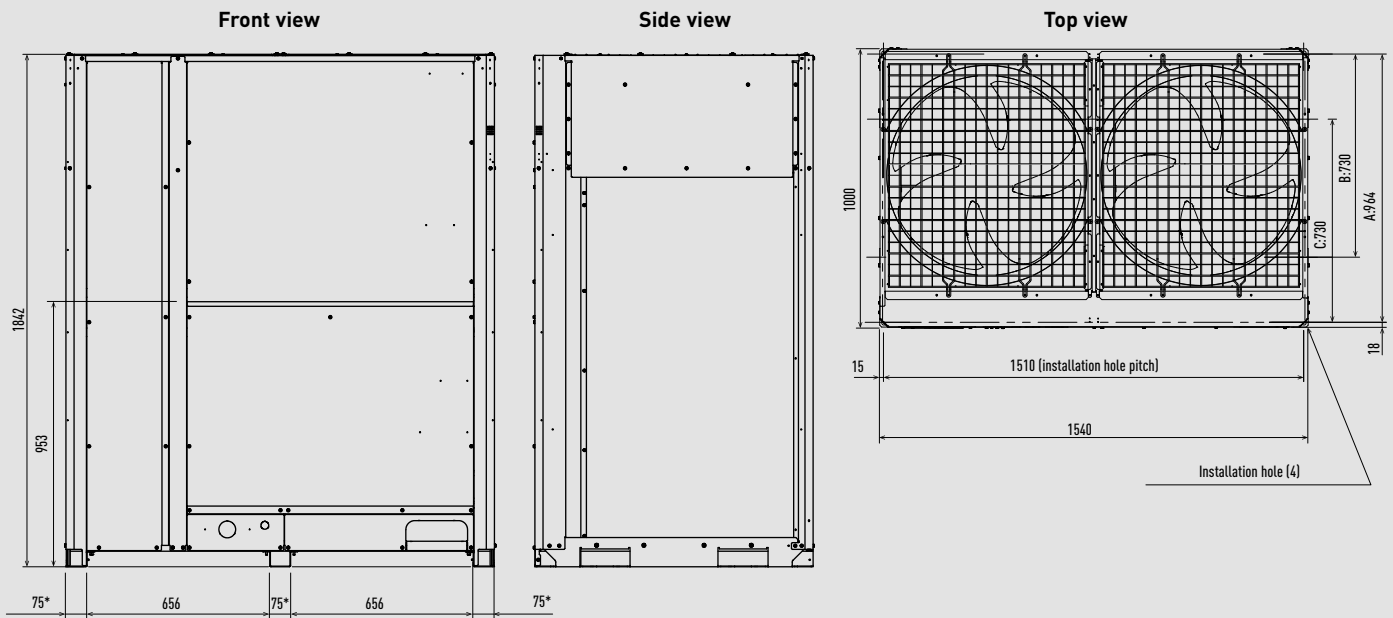

According to the installation site, you may choose the setting position in the depth direction of the anchor bolt from A, B or C.

- A: 964 (installation hole pitch). The piping is routed out from the front.
- B: 730 (installation hole pitch)*. The piping is routed out from the bottom.
- C: 730 (installation hole pitch).

* Installation fixing bracket. Installation side.

Unit: mm

ECO G GE3 Series 16 and 20 HP.

Type	16 HP	20 HP
1 Refrigerant piping (gas)	Ø28,58	
2 Refrigerant piping (liquid)	Ø12,70	Ø15,88
3 Exhaust gas drain port	Hose outer diameter: Ø25 (accessory)	
4 Electrical power supply port	Ø28	
5 Inter-unit cable port	Ø28	
6 Fuel gas port	R3/4	
7 Condensation drain opening	Ø20	
8 Rain and condensation outlet		

Type	16 HP	20 HP
9 Engine exhaust outlet		
10 Suspension holes 4-Ø20x30		
11 Anchor holes 4-22x30		
12 Segmented display		
13 Coolant intake (top)		
14 Air intake		
15 Coolant level		
16 Hot water inlet	Rp3/4	
17 Hot water outlet	Rp3/4	

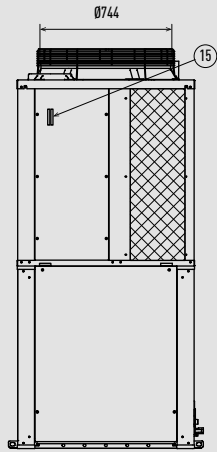
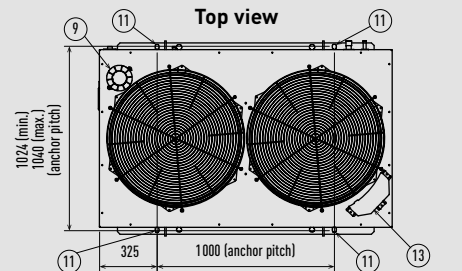

Right view

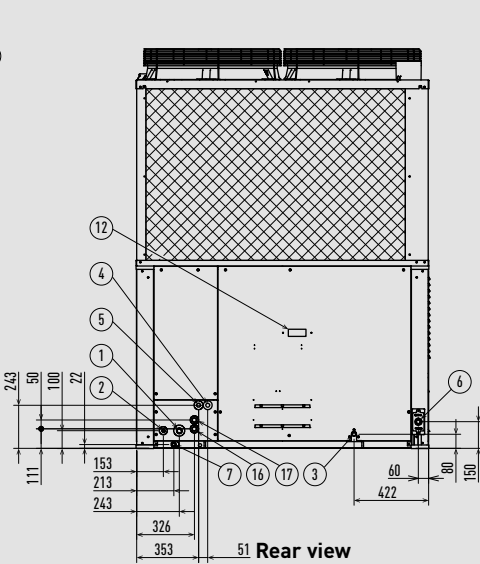

51 Rear view

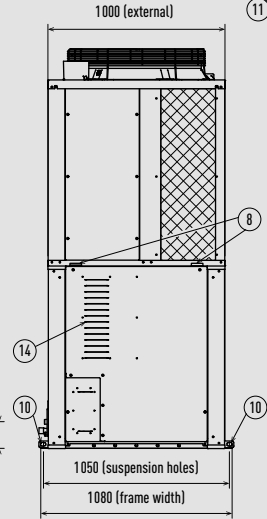

Left view

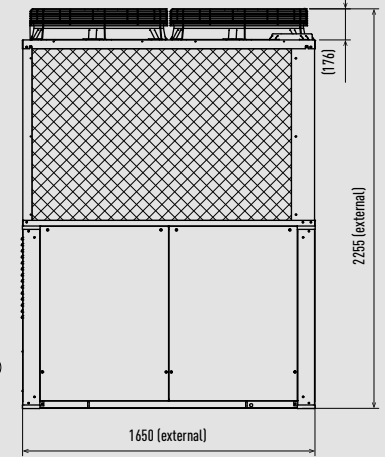

Front view

Unit: mm

ECO G GE3 Series 25 and 30 HP.

Type	25 HP	30 HP
1 Refrigerant piping (gas)	Ø28,58	Ø31,75
2 Refrigerant piping (liquid)	Ø15,88	Ø19,05
3 Exhaust gas drain port	Hose outer diameter: Ø25 (accessory)	
4 Electrical power supply port	Ø28	
5 Inter-unit cable port	Ø28	
6 Fuel gas port	R3/4	
7 Condensation drain opening	Ø20	
8 Rain and condensation outlet		

Type	25 HP	30 HP
9 Engine exhaust outlet		
10 Suspension holes 4-Ø20x30		
11 Anchor holes 4-22x30		
12 Segmented display		
13 Coolant intake (top)		
14 Air intake		
15 Coolant level		
16 Hot water inlet	Rp3/4	
17 Hot water outlet	Rp3/4	

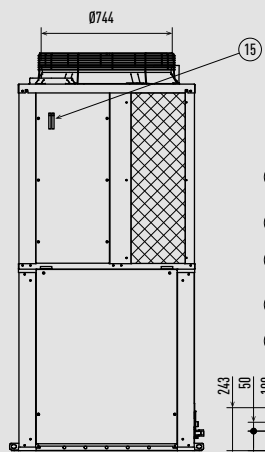
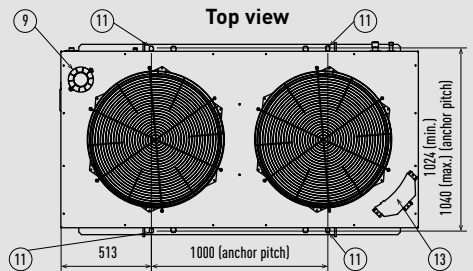

Right view



Rear view

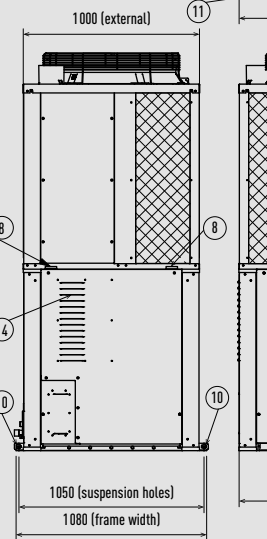

Left view

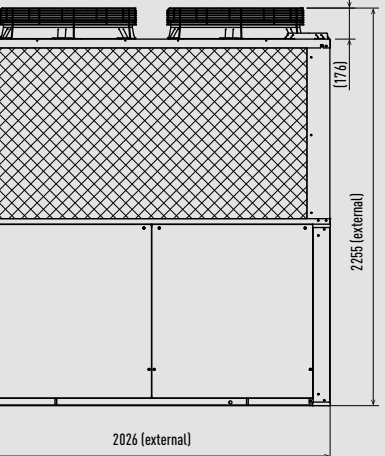

Front view

Unit: mm

ECO G GF3 Series 16 and 20 HP.

Type	16HP	20HP		
1 Suction refrigerant piping (gas)	Ø28,58		8	Condensation drain opening Ø20
2 Discharge refrigerant piping (gas)	Ø22,22	Ø25,40	9	Rain and condensation outlet
3 Refrigerant piping (liquid)	Ø19,05		10	Engine exhaust outlet
4 Exhaust gas drain port	Hose outer diameter: Ø25 (accessory)		11	Suspension holes 4-Ø20x30
5 Electrical power supply port	Ø28		12	Anchor holes 4-22x30
6 Inter-unit cable port	Ø28		13	Segmented display
7 Fuel gas port	R3/4		14	Coolant intake (top)
			15	Air intake
			16	Coolant level
			17	Hot water inlet Rp3/4
			18	Hot water outlet Rp3/4

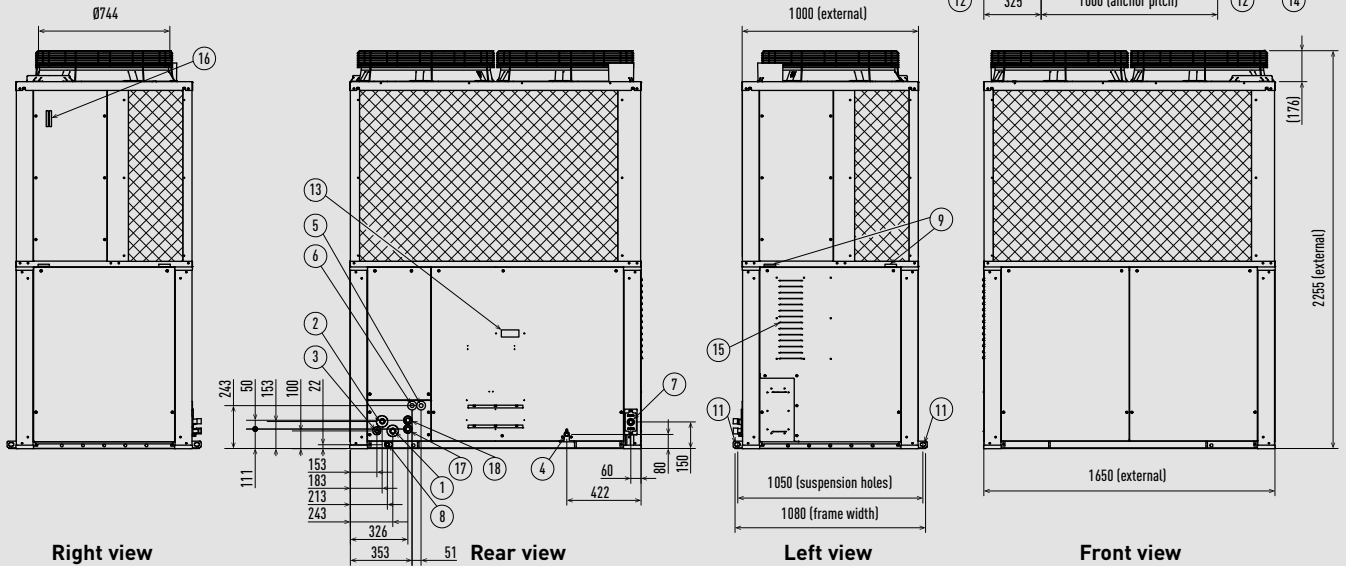
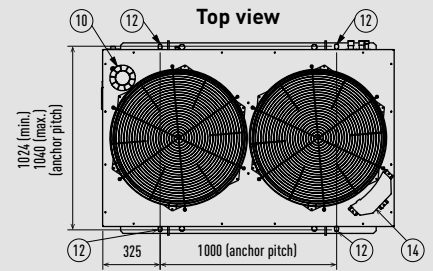

Unit: mm

ECO G GF3 Series 25 HP.

1 Suction refrigerant piping (gas)	Ø28,58	9	Rain and condensation outlet
2 Discharge refrigerant piping (gas)	Ø25,40	10	Engine exhaust outlet
3 Refrigerant piping (liquid)	Ø19,05	11	Suspension holes 4-Ø20x30
4 Exhaust gas drain port	Hose outer diameter: Ø25 (accessory)	12	Anchor holes 4-22x30
5 Electrical power supply port	Ø28	13	Segmented display
6 Inter-unit cable port	Ø28	14	Coolant intake (top)
7 Fuel gas port	R3/4	15	Air intake
8 Condensation drain opening	Ø20	16	Coolant level
		17	Hot water inlet Rp3/4
		18	Hot water outlet Rp3/4

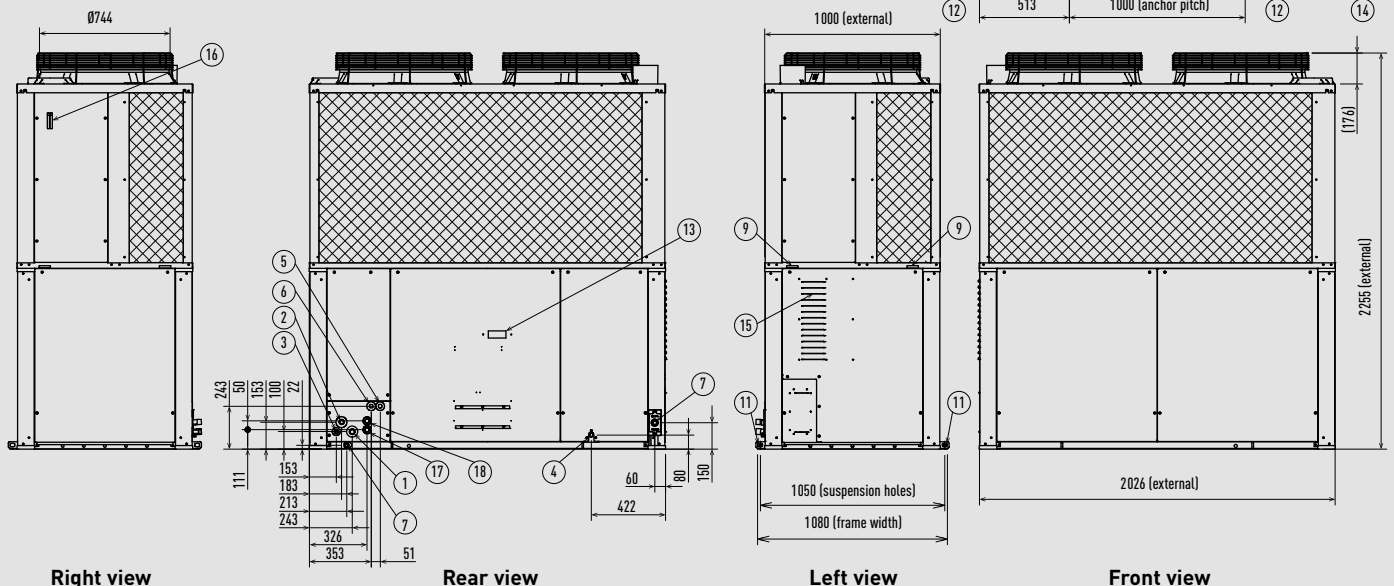
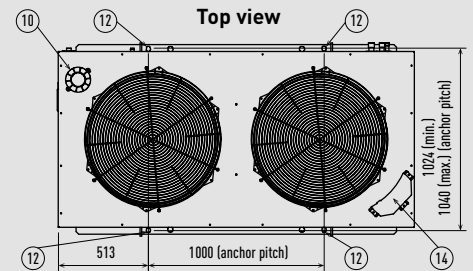

Unit: mm

3-Pipe Control Box Kit / Multiple connection type.

Heat recovery box dimensions

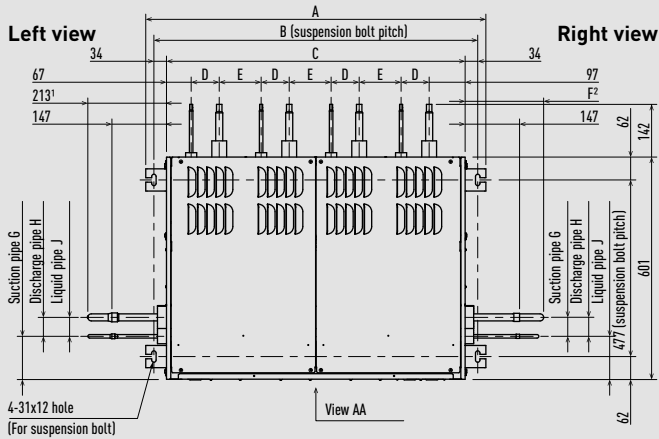

- 1) In case of right side connection.
- 2) Including the protection tubes when connecting to the left side.

Valve dimensions

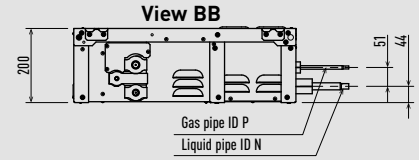
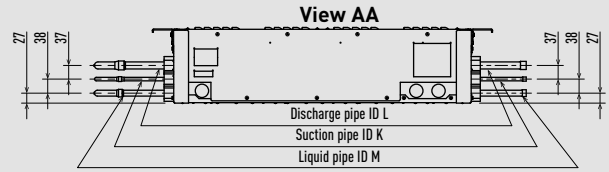
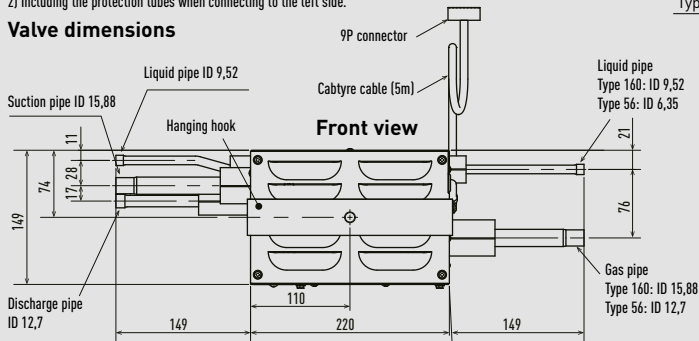

	A	B	C	D	E	F	G	H	J	K	L	M	N	P
Type 456	919	874	807	67	113	213	51	51	117	Ø19,05	Ø15,88	Ø9,52	Ø6,35	Ø12,70
Type 4160	919	874	807	67	113	207	55	54	113	Ø9,52	Ø15,88	Ø28,58	Ø25,40	Ø15,88
Type 656	1297	1253	1185	67	113	213	54	55	115	Ø25,40	Ø19,05	Ø12,70	Ø6,35	Ø12,70
Type 856	1675	1631	1563	67	113	213	53	53	115	Ø28,58	Ø22,22	Ø12,70	Ø6,35	Ø12,70

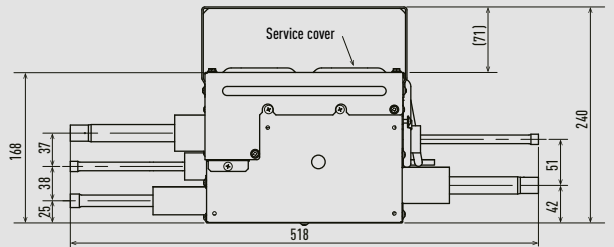

Unit: mm

2-Pipe Hybrid GHP - U-20GES3E5.

- | | |
|--|------------------------------|
| 1 Refrigerant piping (gas), Ø28,58 | 10 Engine exhaust outlet |
| 2 Refrigerant piping (liquid), Ø15,88 | 11 Suspension holes 4-Ø20x30 |
| 3 Knock-out hole. Refrigerant piping (balance) | 12 Anchor holes 4-22x30 |
| 4 Exhaust gas drain port. Hose outer diameter: Ø25 (accessory) | 13 7 segmented display |
| 5 Electrical power supply port, Ø28 | 14 Coolant intake (top) |
| 6 Inter-unit cable port, Ø28 | 15 Air intake |
| 7 Fuel gas port, R3/4 | 16 Coolant level |
| 8 Condensation drain opening, Ø20 | 17 Hot water inlet, Rp3/4 |
| 9 Rain and condensation outlet | 18 Hot water outlet, Rp3/4 |

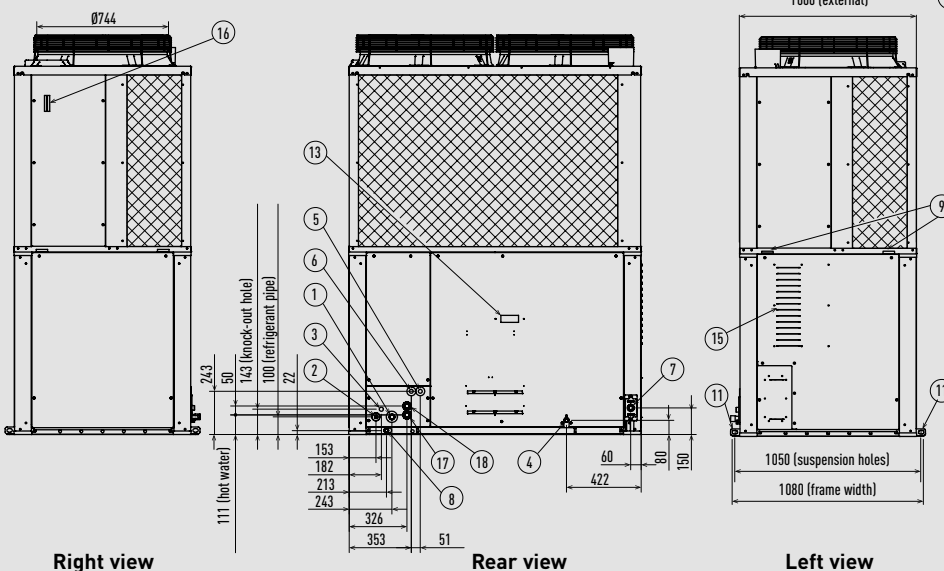
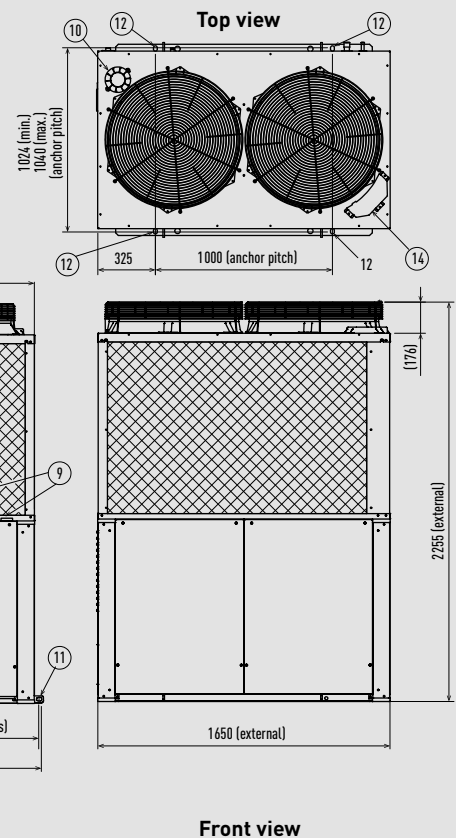

Unit: mm

2-Pipe Hybrid EHP - U-10MES2E8.

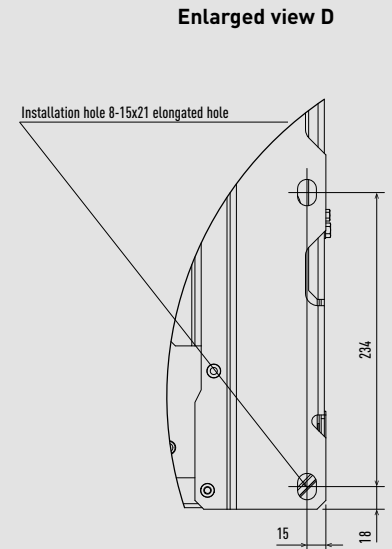
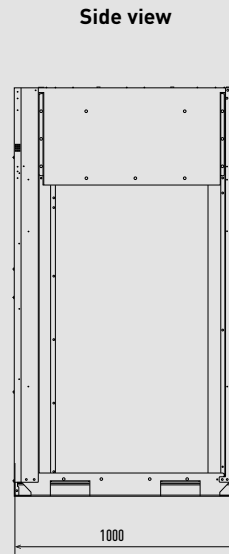
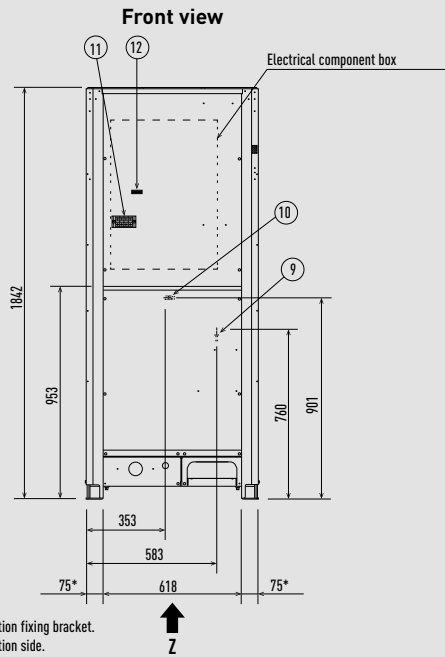
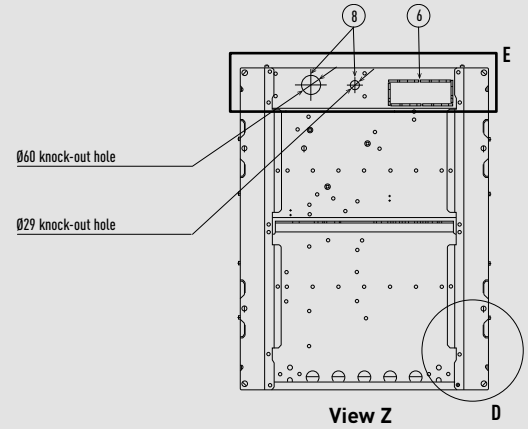
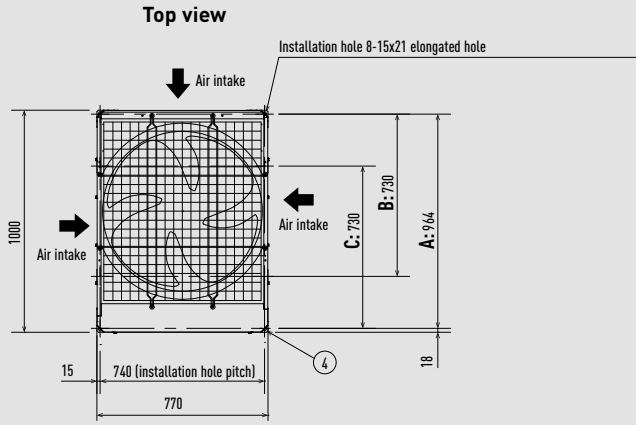

* Installation fixing bracket.
Installation side.

Enlarged view E

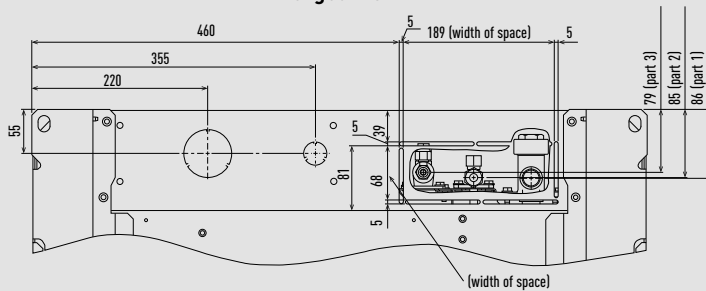

Position of refrigerant pipe connection

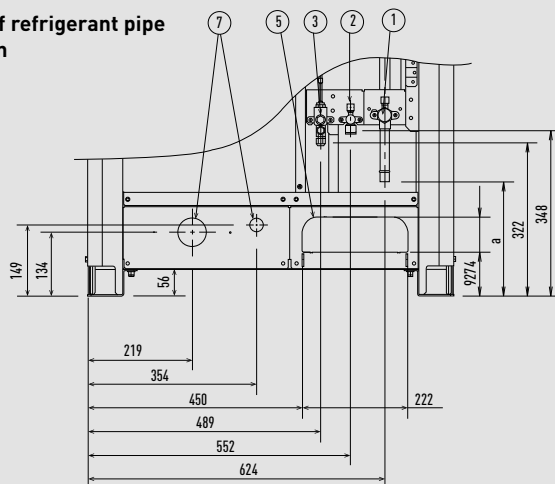

- 1 Refrigerant piping (gas), Ø22,22 (brazed)
- 2 Refrigerant piping (liquid), Ø9,52 (flared)
- 3 Refrigerant piping (balance), Ø6,35 (flared)
- 4 Installation holes (8-15x21 elongated holes), anchor bolts M12 or larger
- 5 Refrigerant piping port (front: knock-out hole)
- 6 Refrigerant piping port (bottom: slit hole)
- 7 Electrical wiring port (front: Ø60, Ø29 knock-out hole - for conduit connection)
- 8 Electrical wiring port (bottom: Ø60, Ø29 knock-out hole - for conduit connection)
- 9 Pressure outlet port (for high pressure: Ø7,94 Schrader type connection)
- 10 Pressure outlet port (for low pressure: Ø7,94 Schrader type connection)
- 11 Terminal plate
- 12 Terminal plate for inter-unit control wiring and/or inter-outdoor unit control wiring

According to the installation site, you may choose the setting position in the depth direction of the anchor bolt from "A", "B" or "C".
 A: 964 (installation hole pitch) * The piping is routed out from the front.
 B: 730 (installation hole pitch) * The piping is routed out from the bottom.
 C: 730 (installation hole pitch)

Water heat exchanger for chilled and hot water production.

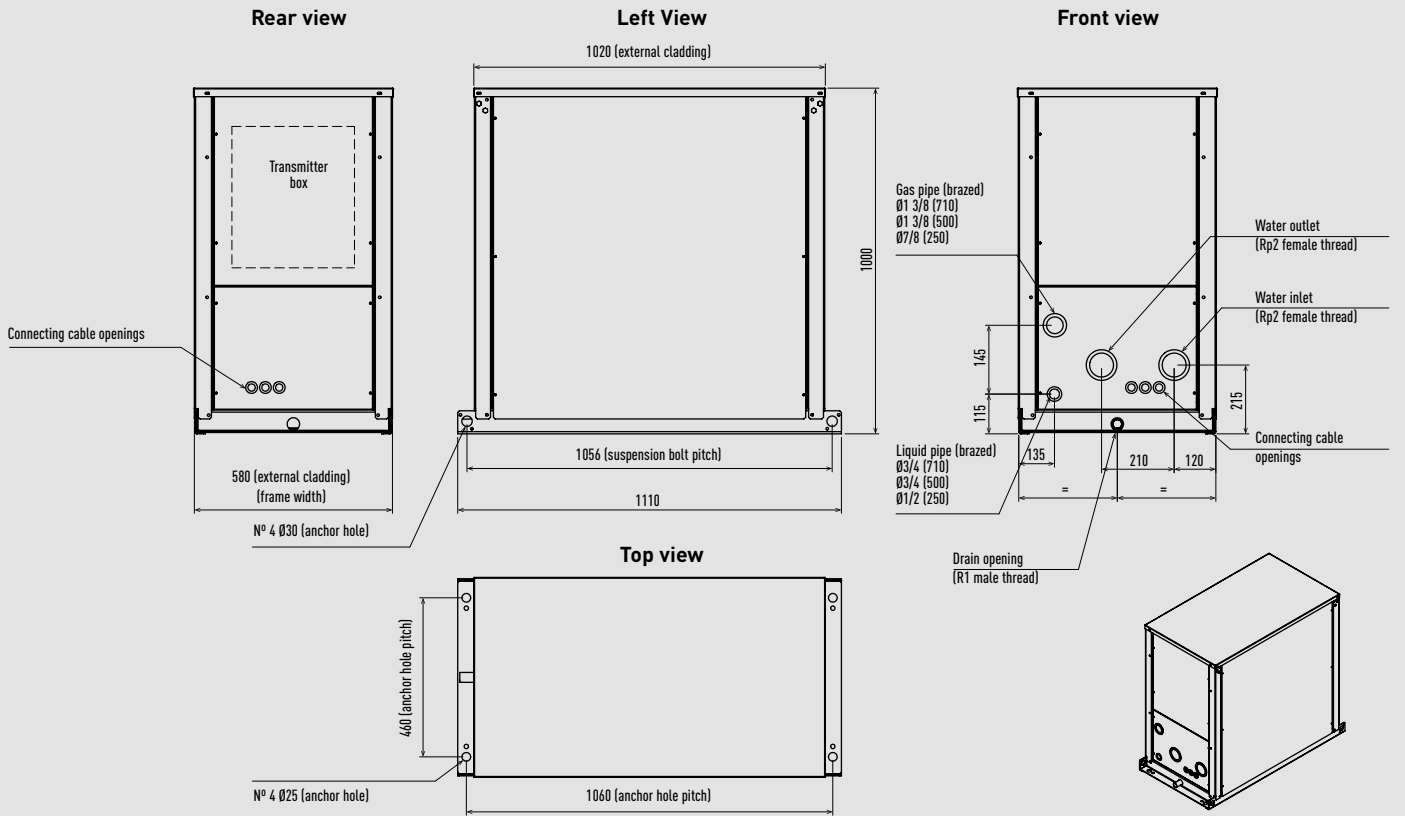

Unit: mm

Y3 type 4 way 60x60 cassette.

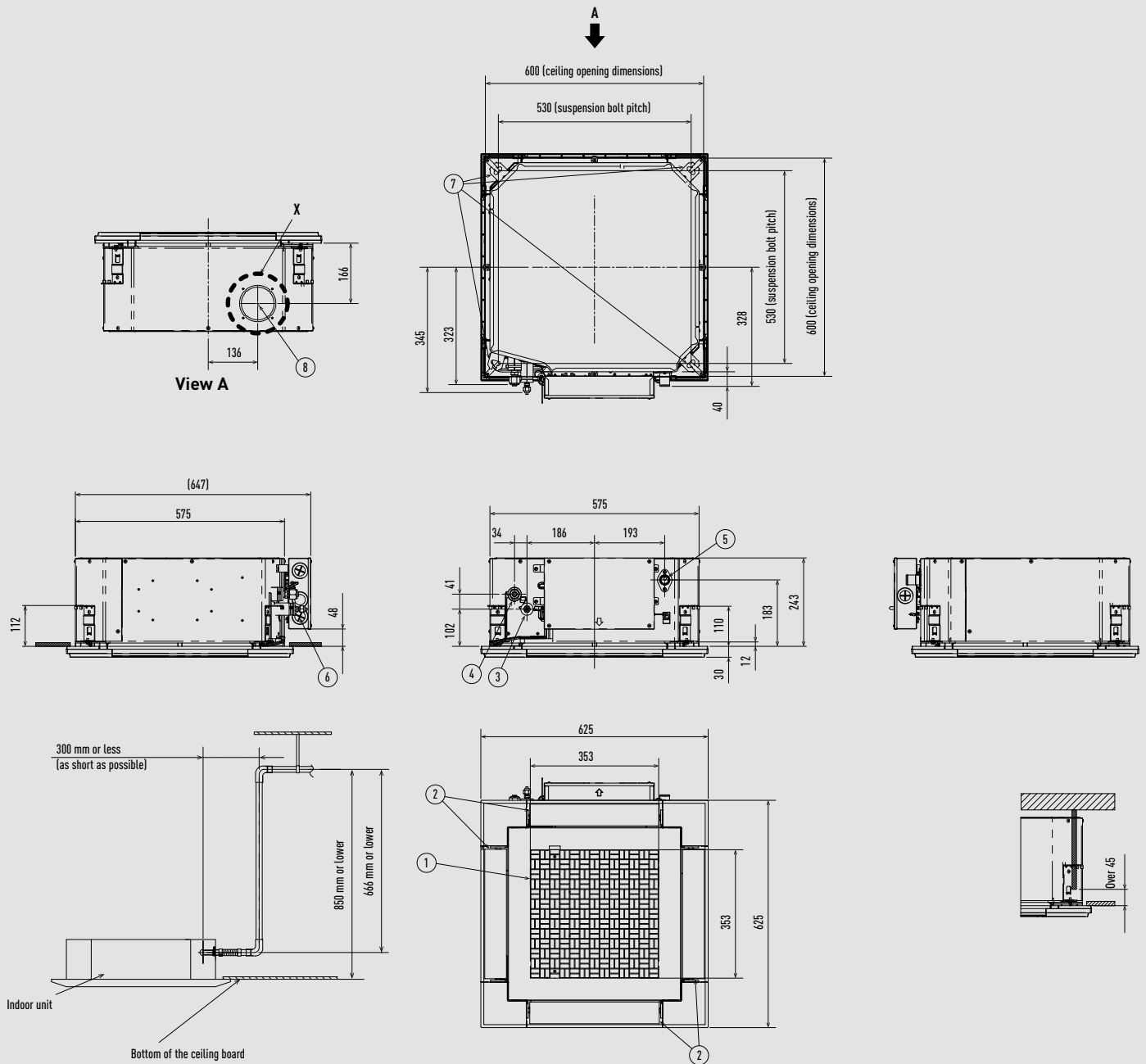

* Length of supplied drain pipe= 250 mm.

1	Air intake	
2	Air outlet	
3	Refrigerant piping (liquid)	Ø6,35 (flared)
4	Refrigerant piping (gas)	Ø12,70 (flared)
5	Drain pipe connection port VP20	
6	Power supply port	
7	Suspension bolt hole [4-11x26 slot]	
8	Fresh air intake duct connection port [Ø100] ³⁾	

- 1) When connecting with U-60PZ3E5A or U-60PZH3E5, connect the liquid socket pipe (Ø9,52-Ø6,35) to the liquid pipe side indoor unit.
- 2) When connecting with U-60PZ3E5A or U-60PZH3E5, connect the gas socket pipe (Ø15,88-Ø12,70) to the gas pipe side indoor unit.
- 3) Necessary to attach duct connecting flange (field supply).

Filter dimension: 362 x 362 x 15 mm.

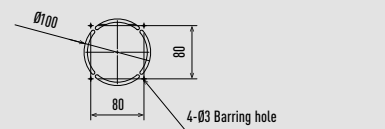

Detailed view X

L1 type 2 Way Cassette.

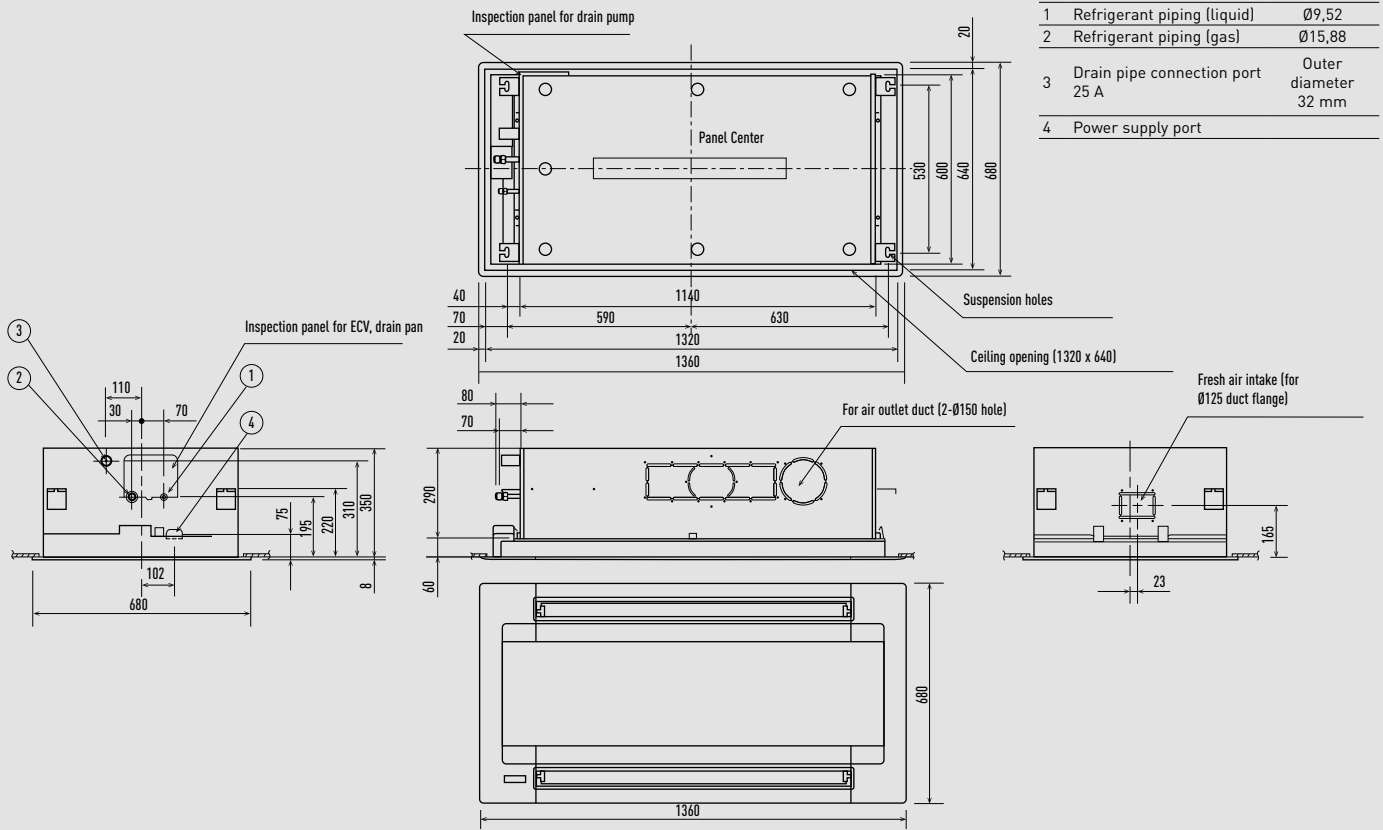

Unit: mm

D1 type 1 way cassette.

	28-56	73
1	Air intake	
2	Air outlet	
3	Refrigerant piping (liquid)	Ø6,35 (flared) Ø9,52 (flared)
4	Refrigerant piping (gas)	Ø12,70 (flared) Ø15,88 (flared)
5	Drain pipe connection port VP25	Outer diameter 32
6	Power supply port	
7	Air outlet duct connection port (for descending ceiling)	
8	Fresh air intake duct connection port Ø100	
9	Installation port for wireless remote controller receiver	
10	Suspension bolt hole	4-12x30 mm

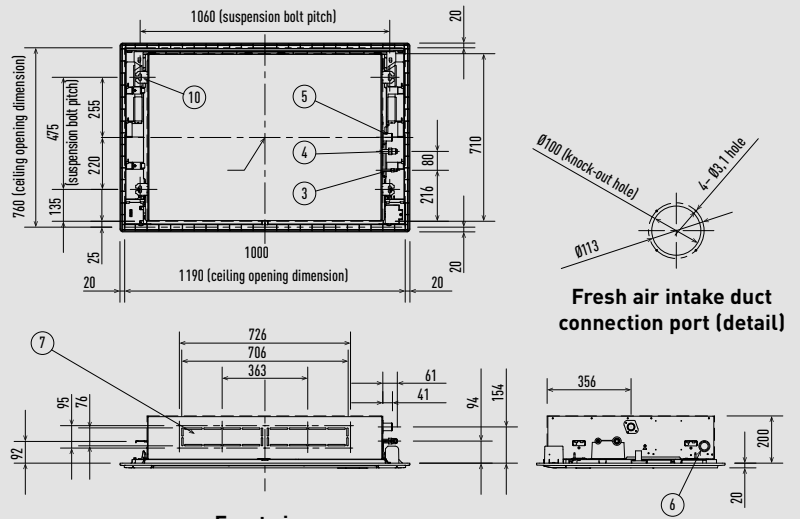

Unit: mm

Space necessary for installation

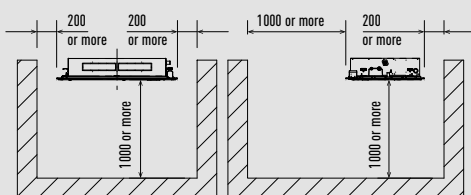

Front view

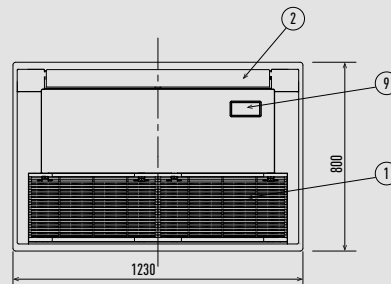

F3 type variable static pressure adaptive duct.

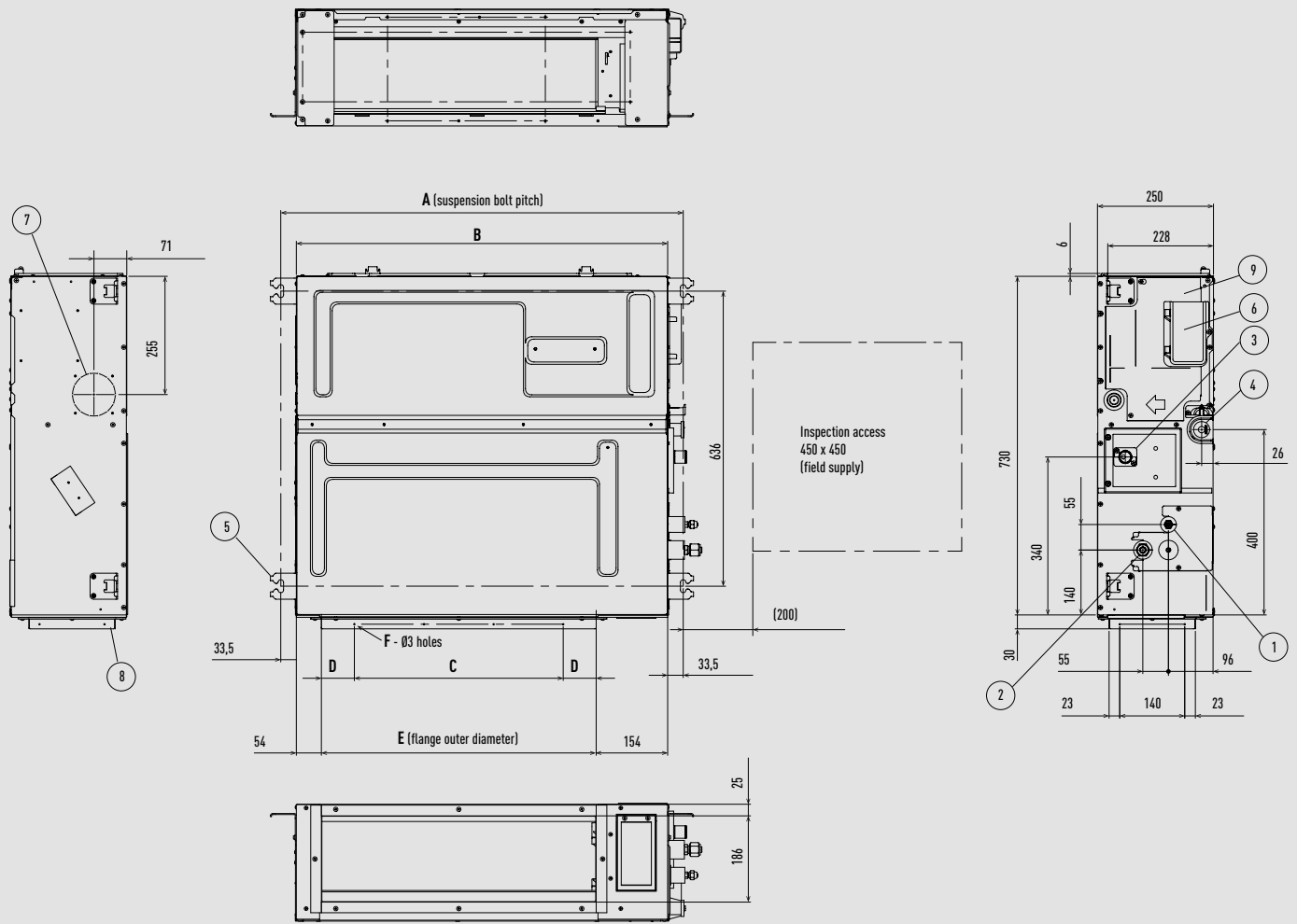

	A	B	C	D	E	F
	mm	mm	mm	mm	mm	Q'ty
S-15MF3E5B, S-22MF3E5B, S-28MF3E5B, S-36MF3E5B, S-45MF3E5B, S-56MF3E5B S-15MF3E5A, S-22MF3E5A, S-28MF3E5A, S-36MF3E5A, S-45MF3E5A, S-56MF3E5A	867	800	450 (pitch 150 x 3)	71	592	12
S-60MF3E5B, S-73MF3E5B, S-90MF3E5B S-60MF3E5A, S-73MF3E5A, S-90MF3E5A	1067	1000	750 (pitch 150 x 5)	21	792	16
S-106MF3E5B, S-140MF3E5B, S-160MF3E5B S-106MF3E5A, S-140MF3E5A, S-160MF3E5A	1467	1400	1050 (pitch 150 x 7)	71	1192	20

Type	15-90MF3E5B	106-160MF3E5B	15-56MF3E5A	60-160MF3E5A
1 Refrigerant piping (liquid)	Ø6,35 (flared)	Ø9,52 (flared)	Ø12,70 (flared)	Ø15,88 (flared)
2 Refrigerant piping (gas)				
3 Upper drain pipe connection port VP20	Outer diameter 26 mm, 200 mm flexible hose supplied			
4 Bottom drain pipe connection port VP20	Outer diameter 26 mm			
5 Suspension lug	4-12x30 mm			
6 Power supply outlet				
7 Fresh air intake port	Ø100 mm*			
8 Flange for flexible air discharge duct				
9 Electrical component box				

* Necessary to attach duct connecting flange (field supply).

F2 type variable static pressure hide-away.

S-15MF2E5A / S-22MF2E5A / S-28MF2E5A / S-36MF2E5A / S-45MF2E5A / S-56MF2E5A

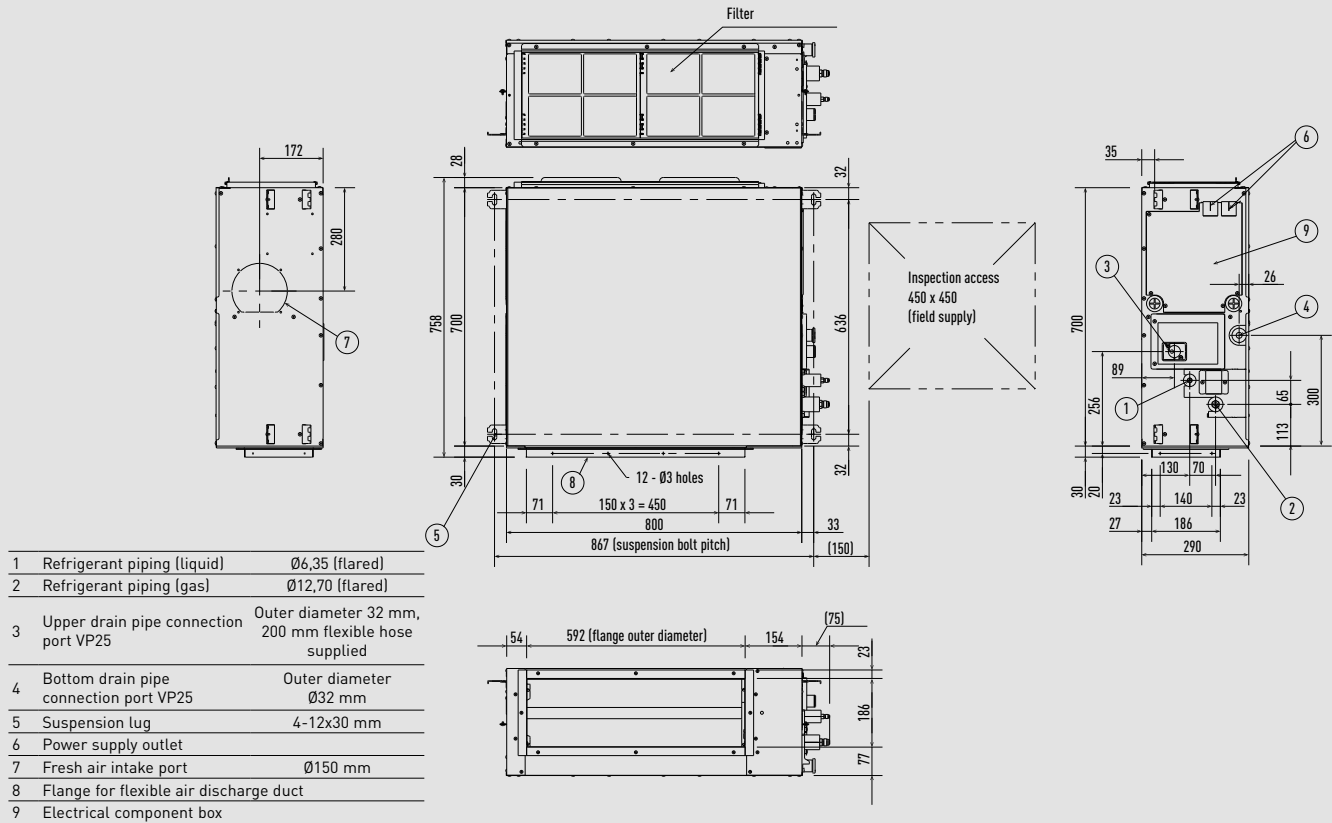

S-60MF2E5A / S-73MF2E5A / S-90MF2E5A

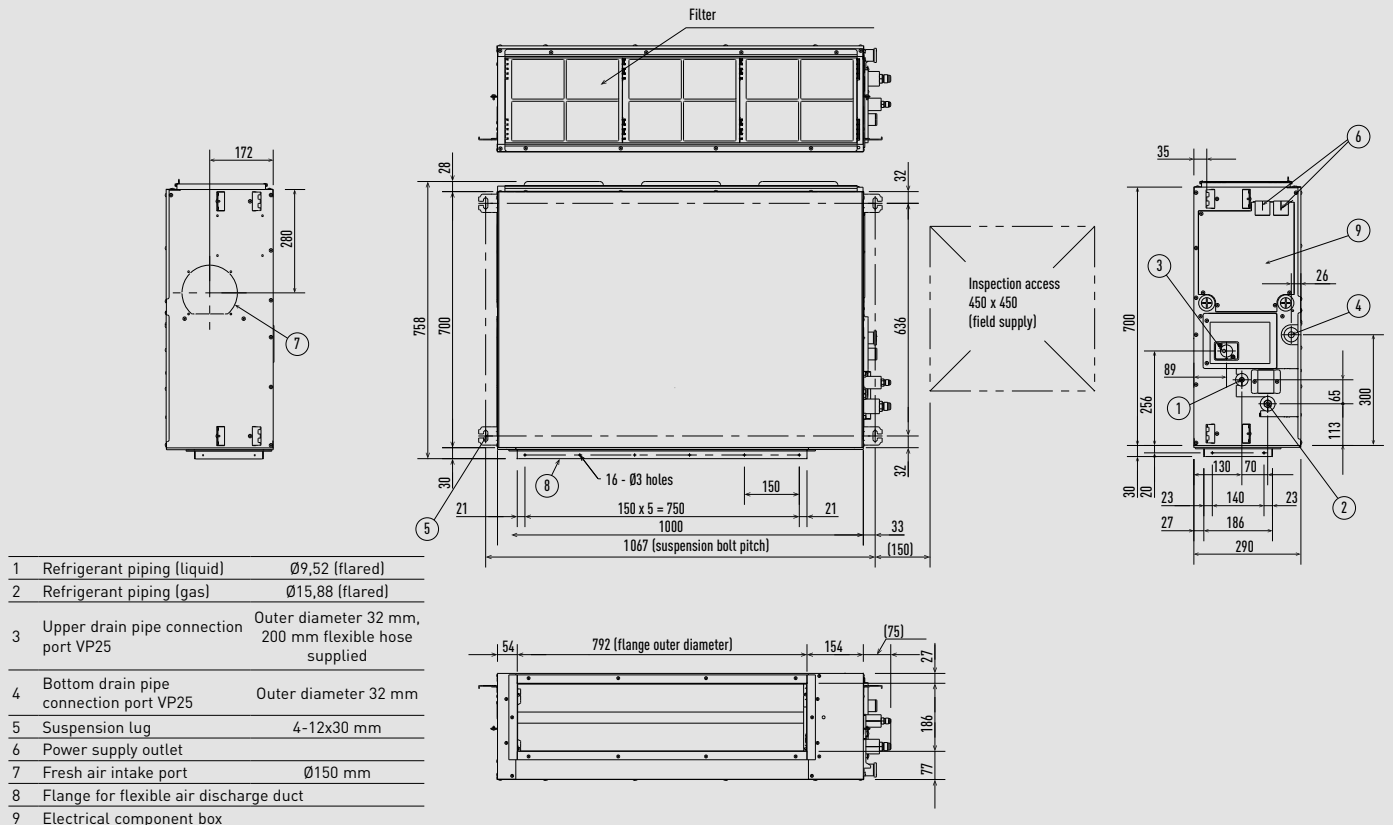

F2 type variable static pressure hide-away.

S-106MF2E5A / S-140MF2E5A / S-160MF2E5A

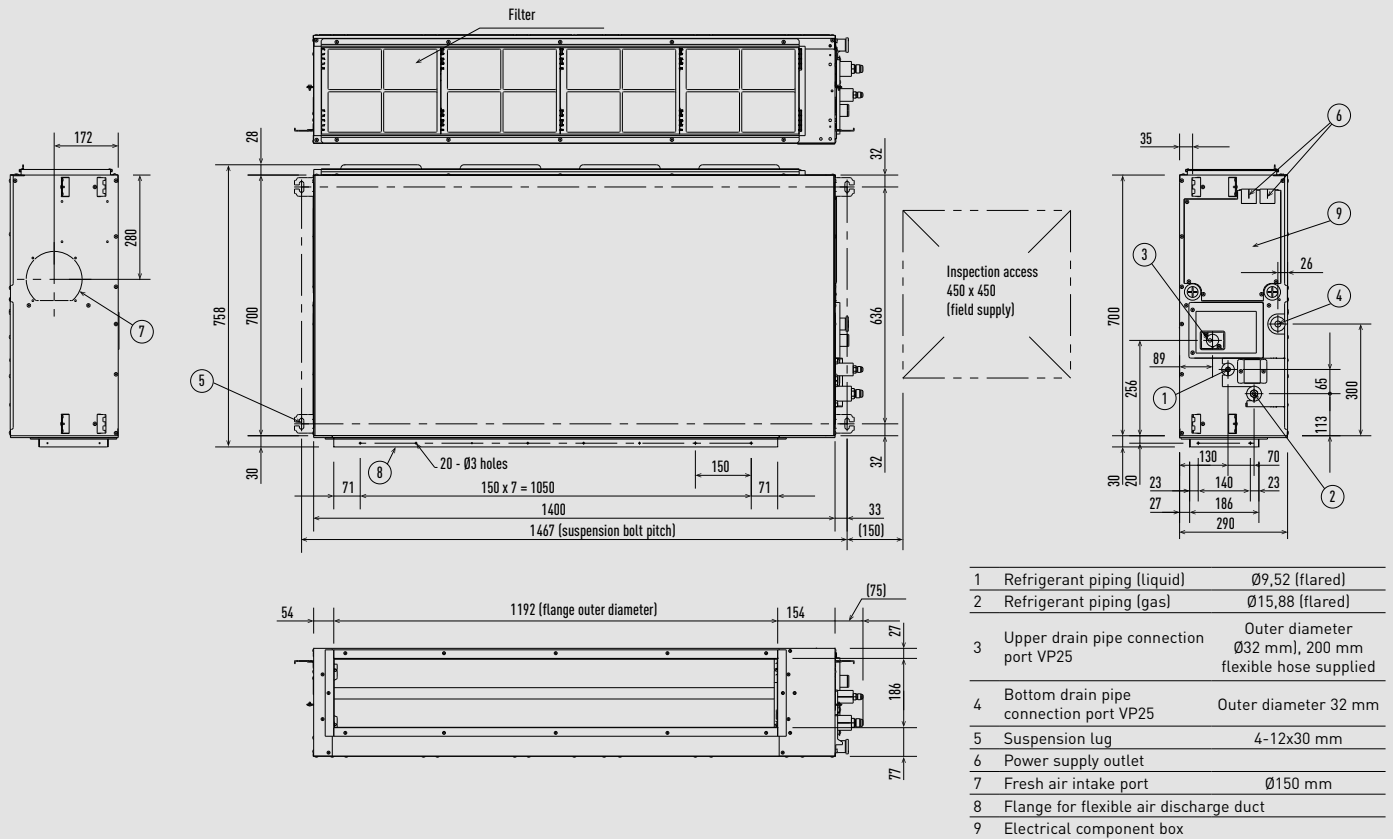

Unit: mm

M1 type slim variable static pressure hide-away concealed duct

1	Refrigerant piping (narrow pipe)	
2	Refrigerant piping (wide pipe)	
3	Upper and bottom drain port	Outer diameter 26 mm
4	Suspension lug	
5	Power supply outlet	2- Ø30
6	Flange for air intake duct	
7	PL cover	
8	Electrical component box	
9	Frame filter	
10	Signal output board	ACC-SG-AGB: optional

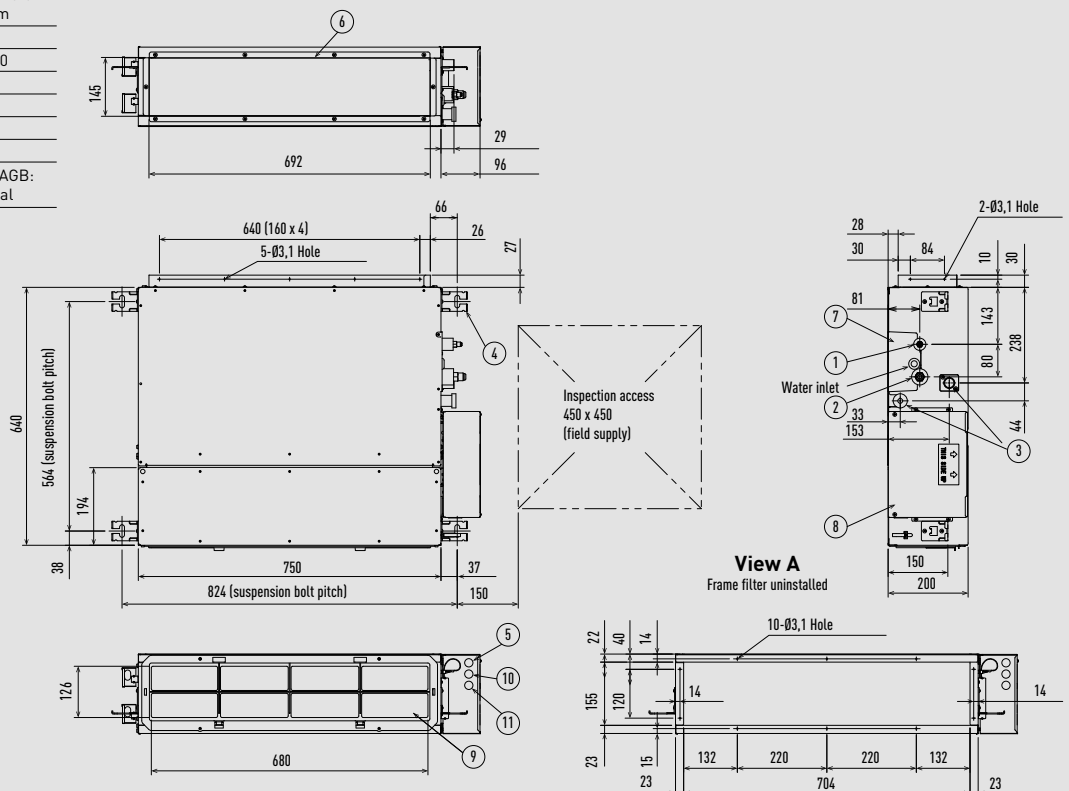

Unit: mm

E2 type high static pressure hide-away.

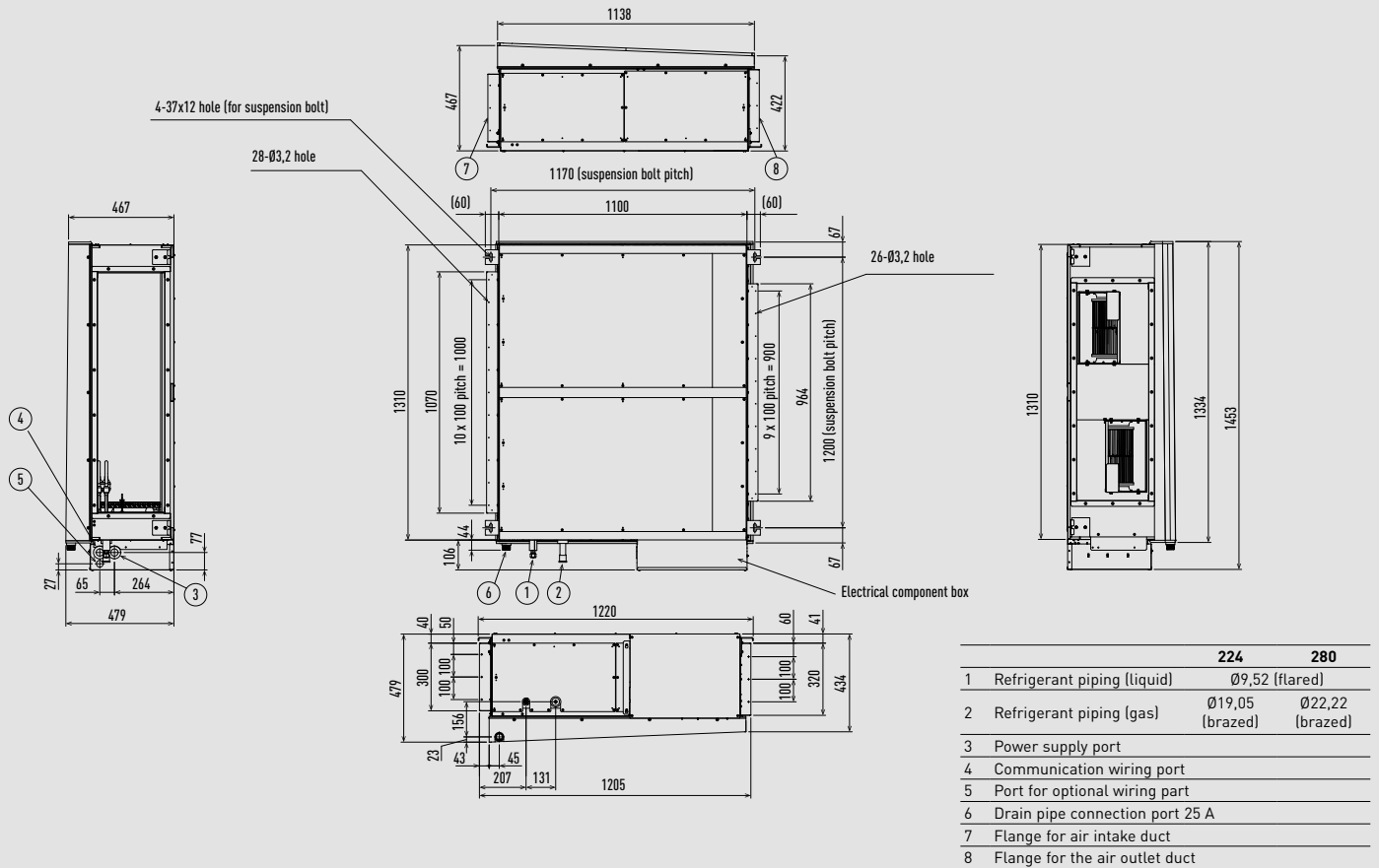

Unit: mm

Heat recovery with DX coil.

	A	B	C	D	E	E1	F	F1	G	L	T	K	M	N	P	R	S	Y	Z	Net weight
PAW-500ZDX3N	904	1400	107	200	825	1395	960	830	19	955	500	135	270	350	135	135	202	350	135	90 - 98
PAW-800ZDX3N	1134	1745	85	250	1115	1735	1190	1060	19	1200	678	170	388	500	170	170	228	415	195	100 - 110
PAW-01KZDX3N	1216	1700	85	250	1130	1700	1273	1140	19	1290	621	171	388	550	146	241	151	415	195	105 - 120

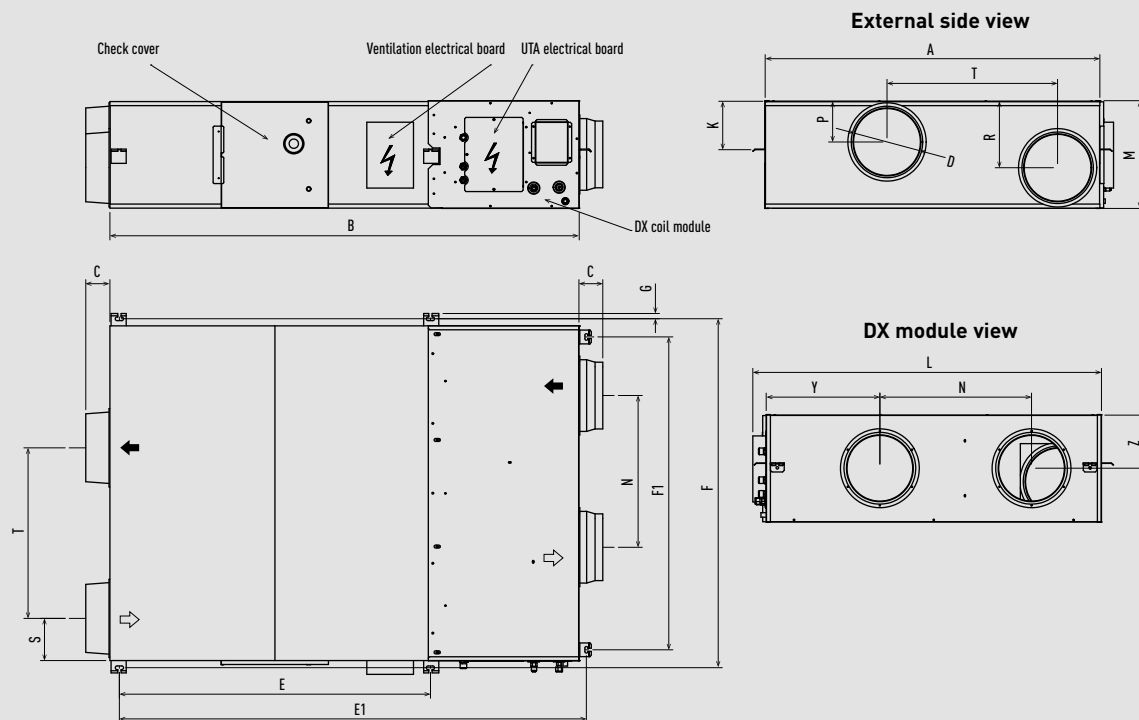

Unit: mm

T2 type ceiling.

S-36MT2E5A / S-45MT2E5A / S-56MT2E5A

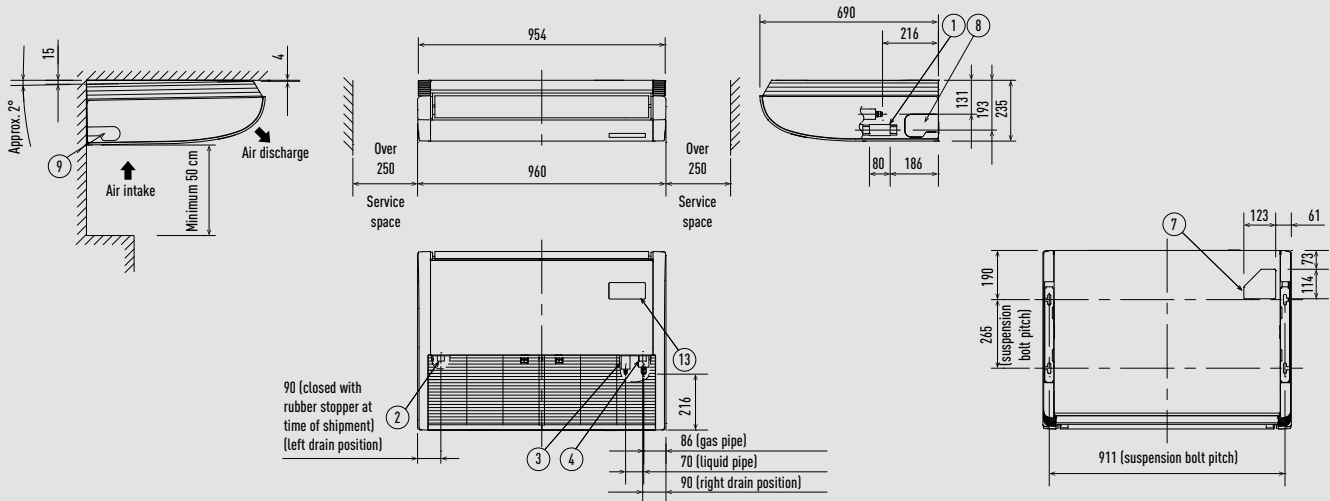

S-73MT2E5A

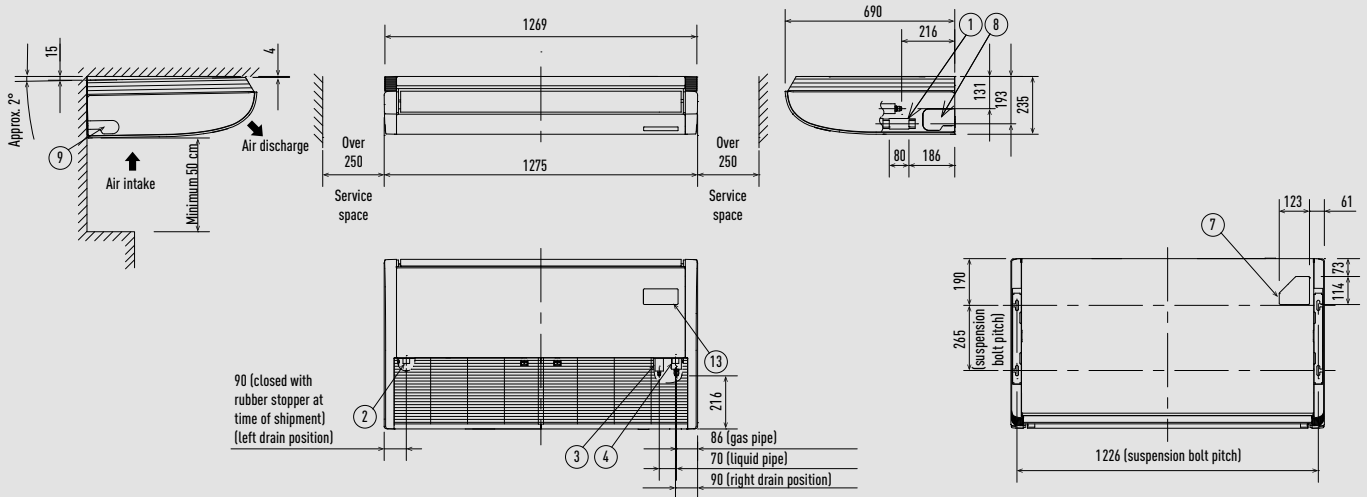

S-106MT2E5A / S-140MT2E5A

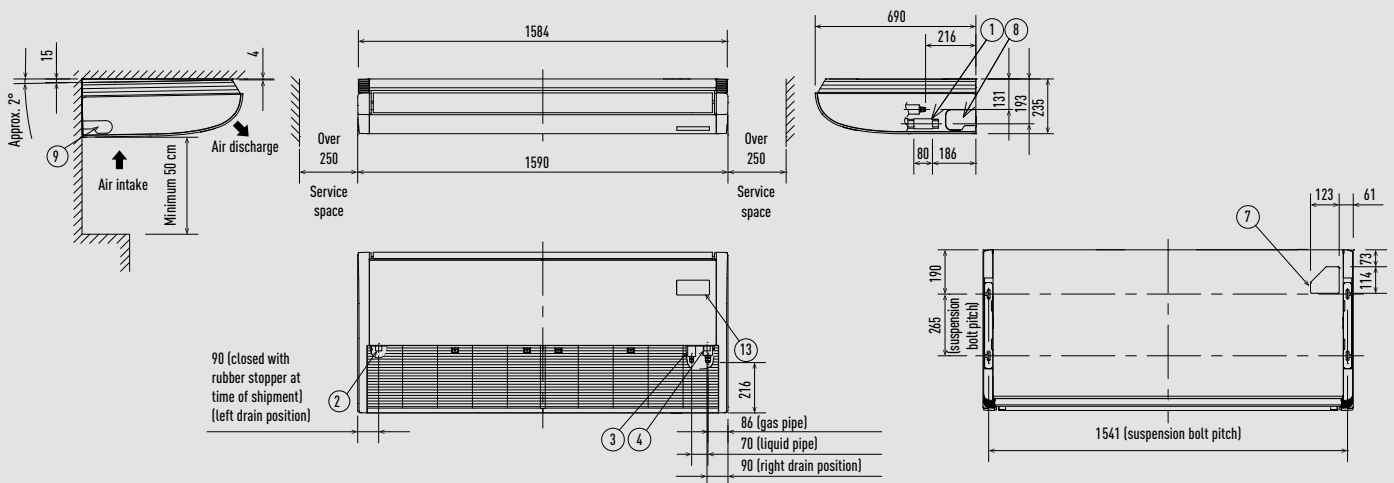

1	Drain pipe connection port VP20	Inside diameter \varnothing 26 mm, drain hose supplied	5	Left side drain hose outlet port (cut out)	
2	Left drain position		6	Piping hole on wall surface	\varnothing 100 mm
3	Refrigerant piping (liquid)	\varnothing 9,52 (flared)	7	Upper side piping port	
4	Refrigerant piping (gas)	\varnothing 15,88 (flared)	8	Right side drain hose outlet port (cut out)	
			9	Wireless remote controller receiver installation location	

Unit: mm

K2 type wall-mounted.

S-15MK2E5B / S-22MK2E5B / S-28MK2E5B / S-36MK2E5B

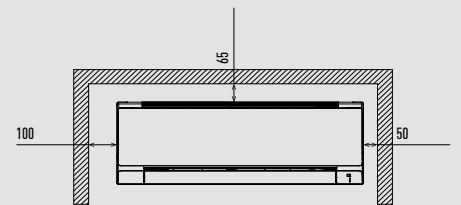
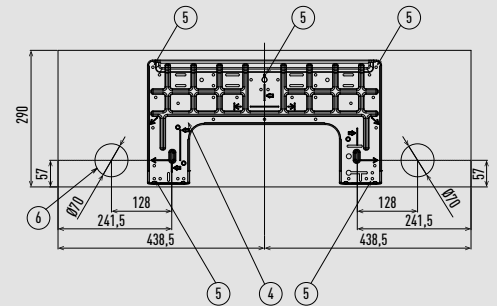
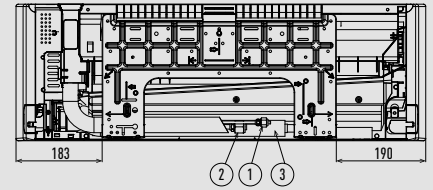
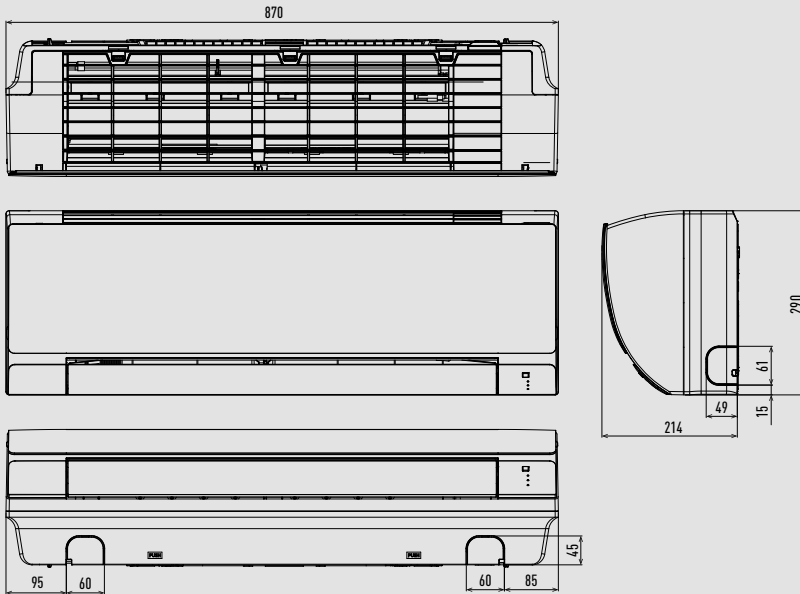

1	Refrigerant piping (liquid)	Ø6,35 (flared)
2	Drain hose	Outer diameter 16 mm
3	Rear panel	PL Back
4	Refrigerant piping (gas)	Ø12,70 (flared)
5	Rear panel fixing holes	
6	Piping and wiring holes	Ø70

S-45MK2E5B / S-56MK2E5B / S-73MK2E5B / S-106MK2E5B

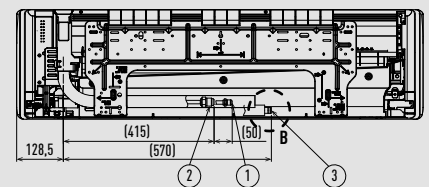
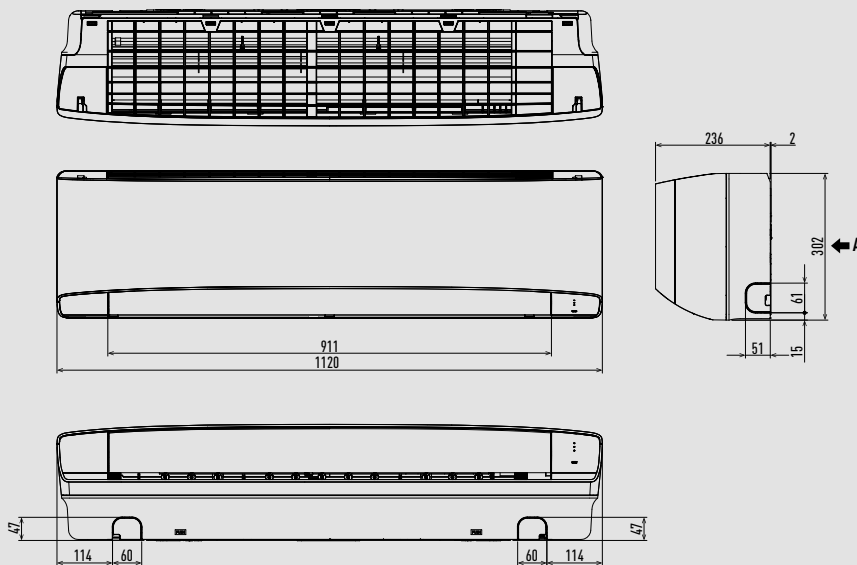

View A

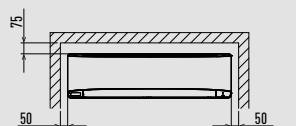
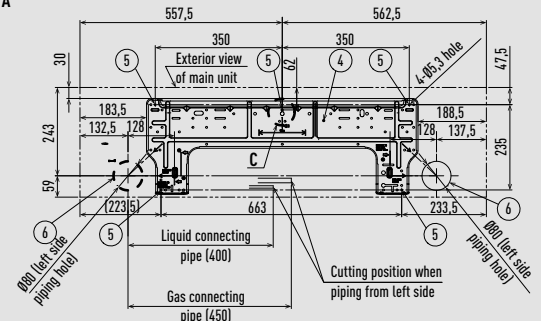

Minimum space requirements for installation

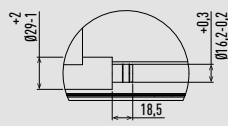

Detailed view B

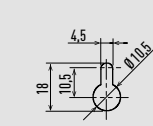

Detailed view C

Type	45-56	73-106
1	Refrigerant piping (liquid)	Ø6,35 (flared)
2	Refrigerant piping (gas)	Ø12,70 (flared)
3	Drain hose	Ø9,52 (flared)
4	Rear panel	
5	Rear panel fixing holes (Ø5,3 holes or as shown in figure "C")	
6	Piping and wiring holes (Ø80)	

Unit: mm

G1 type floor console.

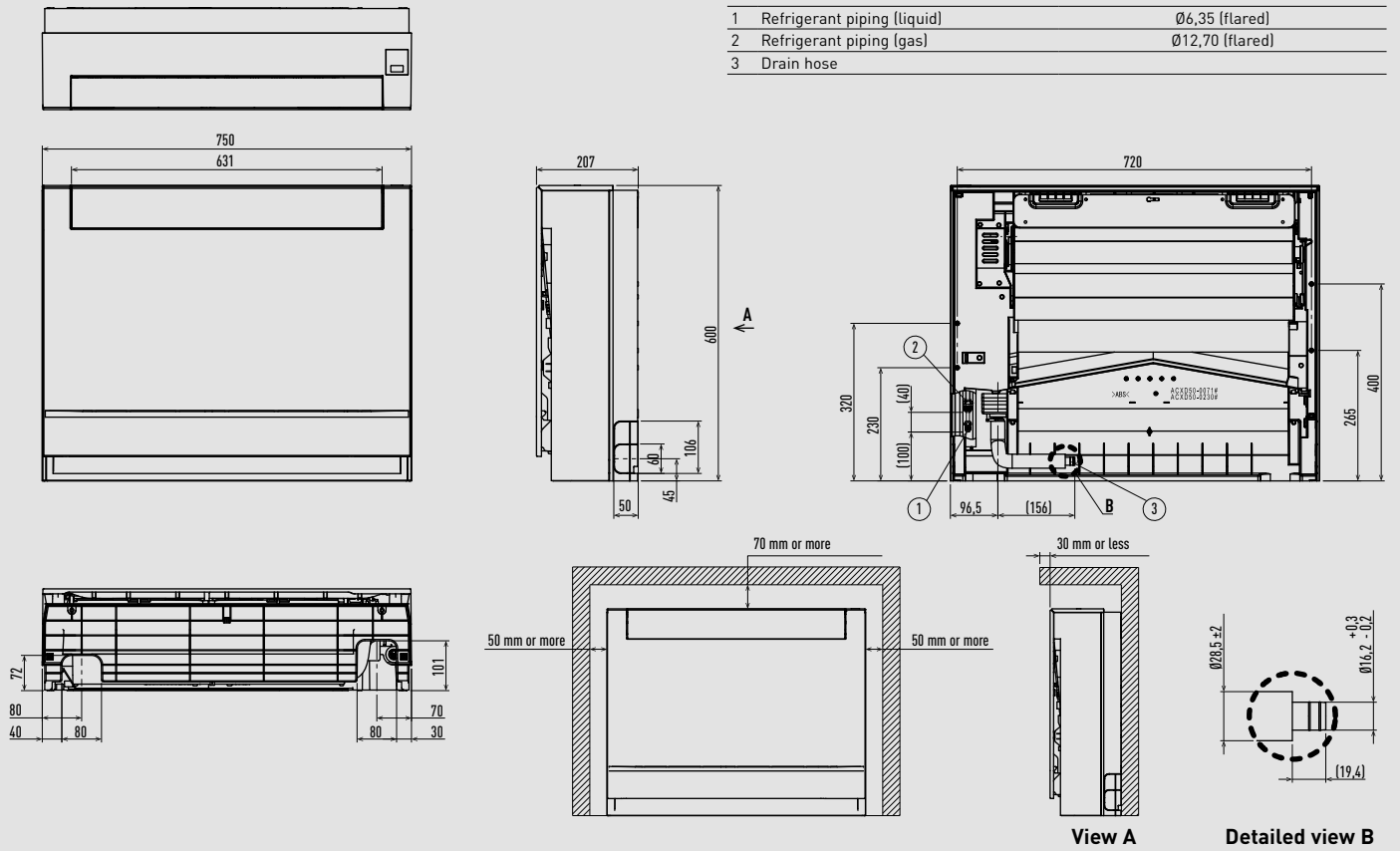

Unit: mm

P1 type floor-standing.

- 1 4- $\varnothing 12$ hole (for fastening the indoor unit to the floor with screws)
- 2 Air filter
- 3 Refrigerant piping (liquid)
- 4 Refrigerant piping (gas)
- 5 Level adjusting bolt
- 6 Drain pipe connection port 20 A
- 7 Power cord outlet (downward, rear)
- 8 Refrigerant piping outlet (downward, rear)
- 9 Location for mounting the remote controller (remote controller can be attached within the room)

	A	B	C	Liquid pipes	Gas pipes
22-36	1065	665	632		
45				$\varnothing 6,35$	$\varnothing 12,70$
56	1380	980	947		
71				$\varnothing 9,52$	$\varnothing 15,88$

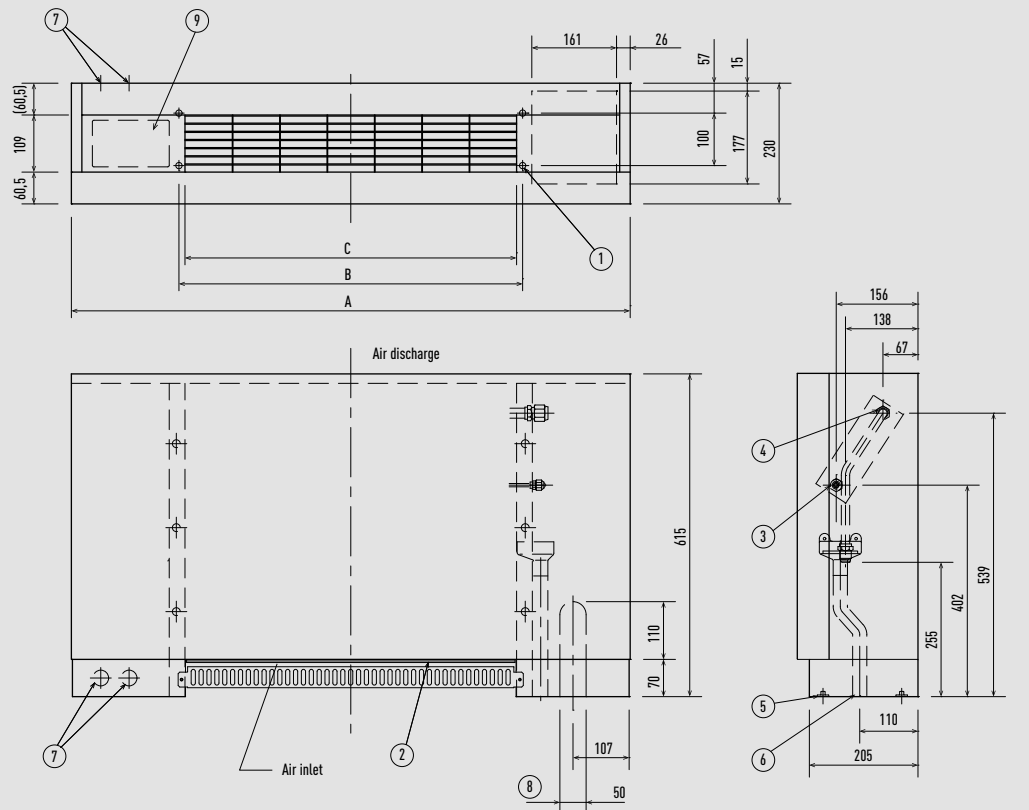

Unit: mm

R1 type concealed floor-standing.

- 1 4-Ø12 hole (for fastening the indoor unit to the floor with screws)
- 2 Air filter
- 3 Refrigerant piping (liquid)
- 4 Refrigerant piping (gas)
- 5 Level adjusting bolt
- 6 Drain pipe connection port 20 A
- 7 Flange for the air outlet duct

	22-36	45	56	71
A	904	1219		
B	692	1007		
C	672	1002		
D	665	980		
E	500	900		
F	86	51		
Liquid pipes		Ø6,35		Ø9,52
Gas pipes		Ø12,70		Ø15,88

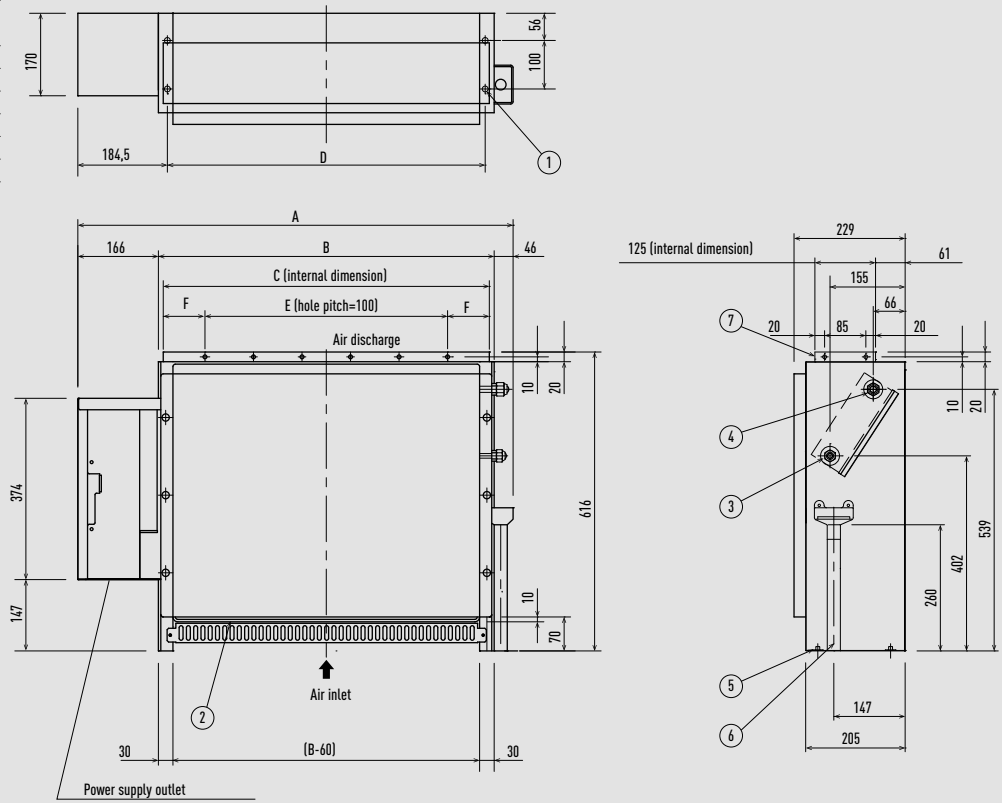

Unit: mm

Hydrokit for ECOi, water at 45 °C.

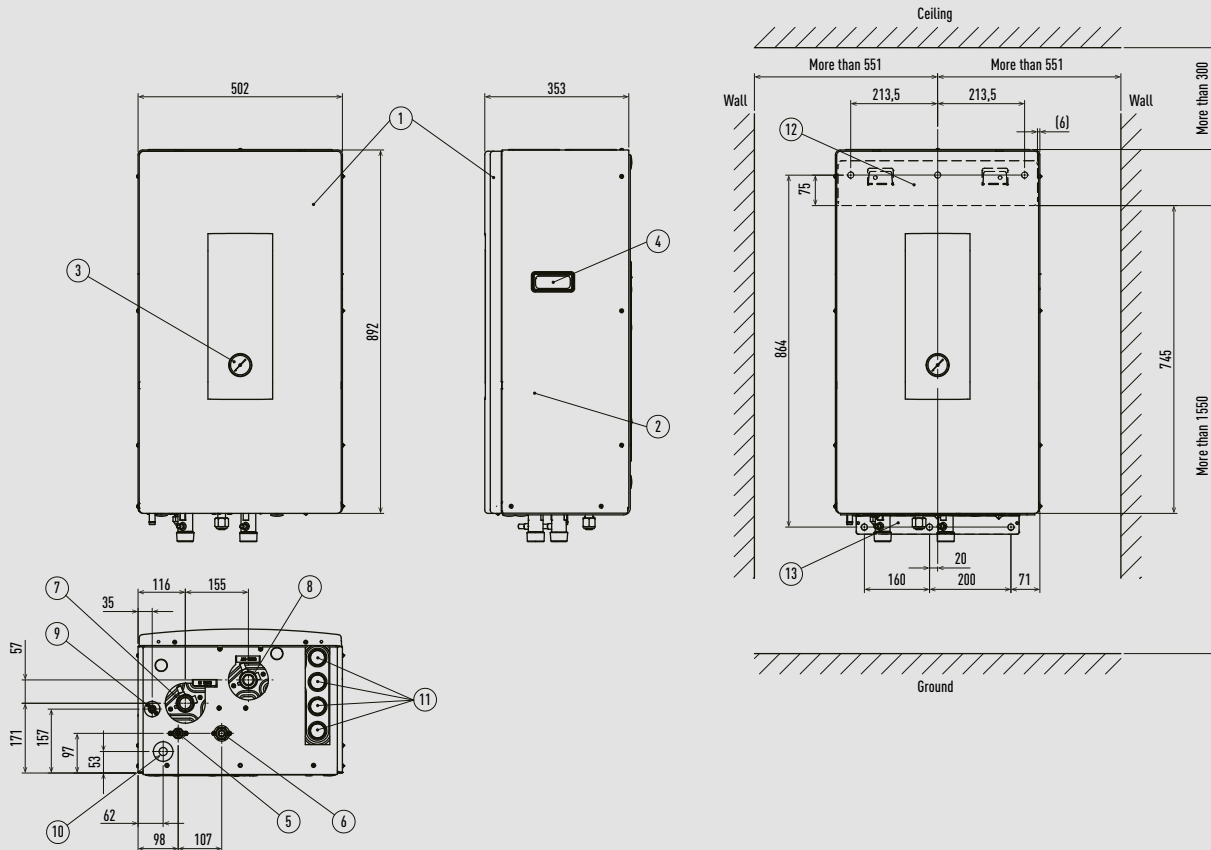

Unit: mm

ECOi PRO-HT Tank.

PAW-VP750LDHW-1

PAW-VP1000LDHW-1

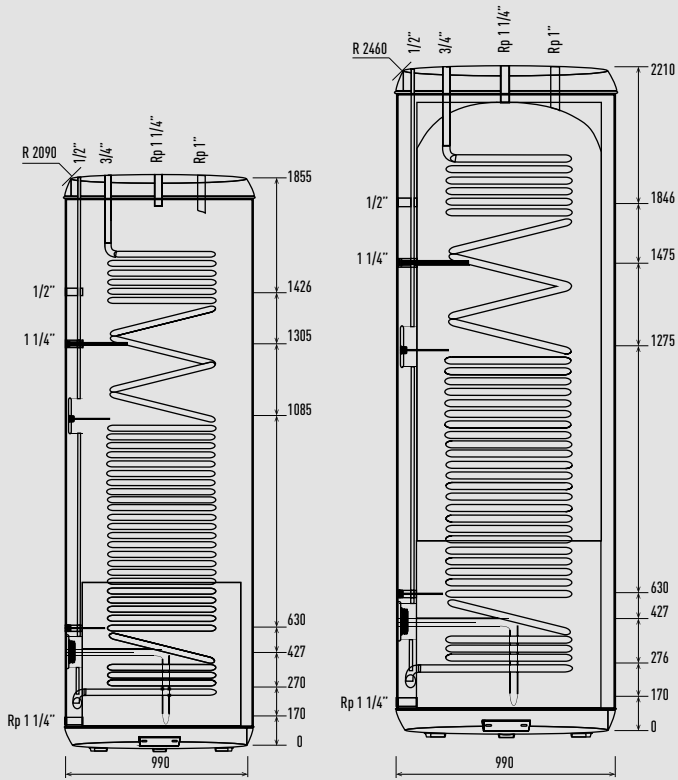

Note: R value indicates maximum overturning height.

Unit: mm

Smart fan coils.

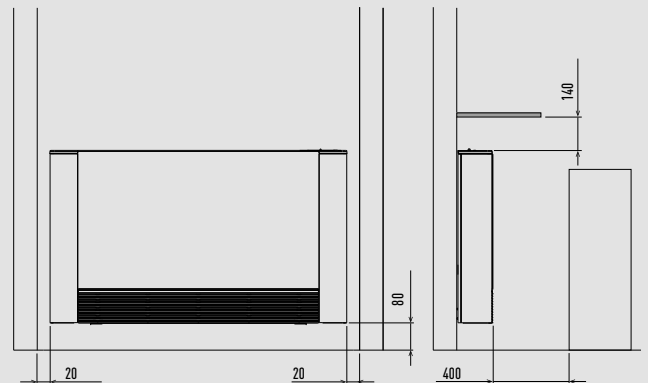
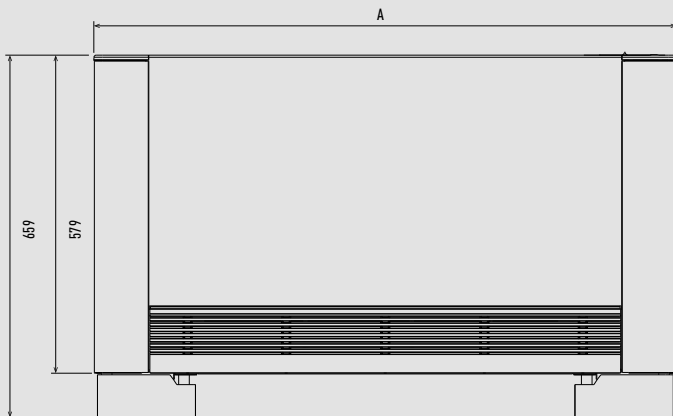

	PAW-AAIR-200-2	PAW-AAIR-700-2	PAW-AAIR-900-2
A	735	935	1135

Unit: mm

AHU connection kit for PACi NX, ECOi and ECO G.

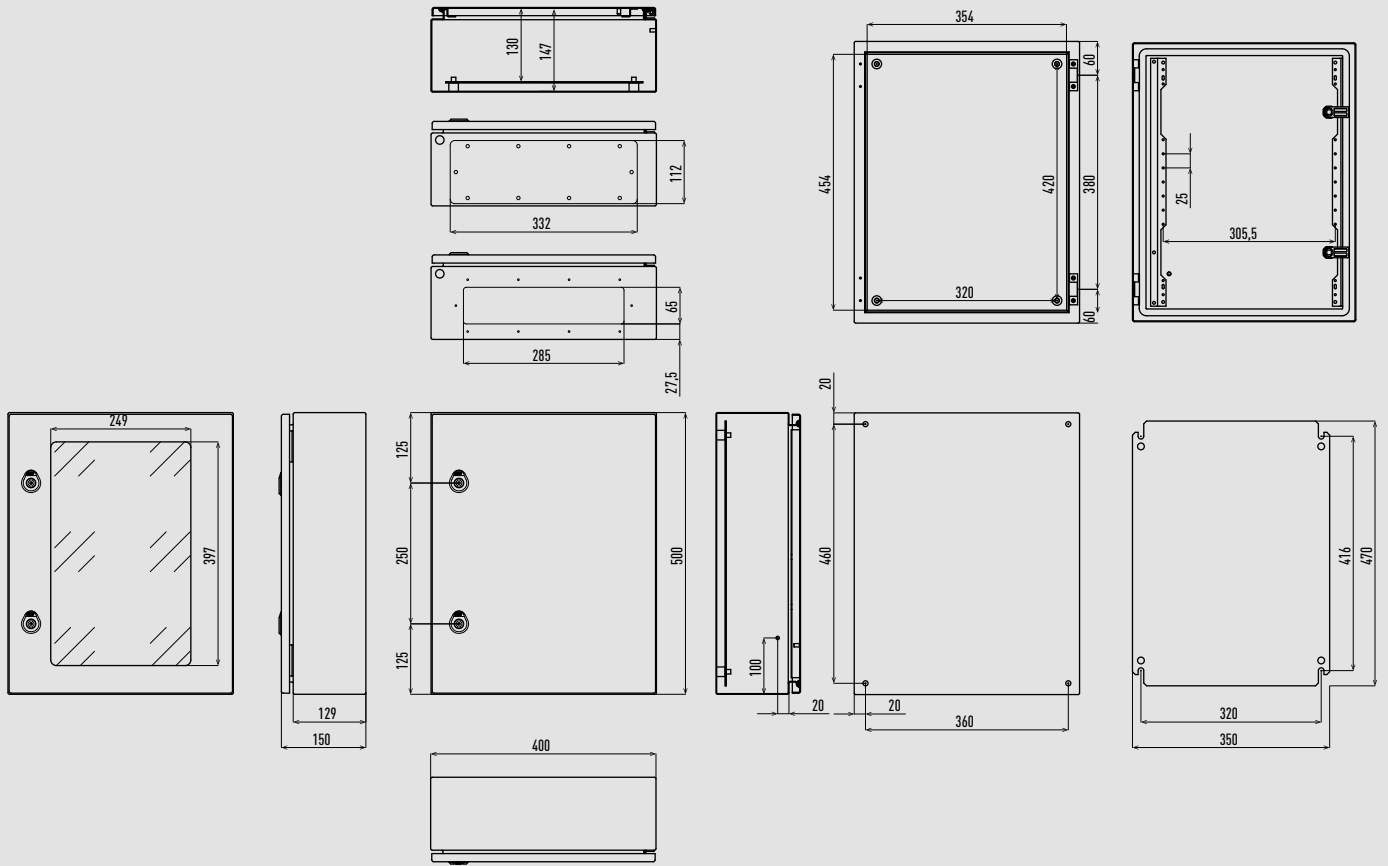

Unit: mm

Advanced energy recovery ventilation.

FV-15ZY1G / FV-25ZY1G / FV-35ZY1G / FV-50ZY1G / FV-65ZY1G / FV-80ZY1G / FV-1KZY1G

	A	B	C	D	E	F	G	H	J	K	L	M	N	Duct diameter
FV-15ZY1G	860	666	786	610	289	144,5	102	Ø97,6	Ø150	395	107,5	116	168	Ø100
FV-25ZY1G	860	791	786	735	289	144,5	102	Ø145	Ø200	470	132,5	116	168	Ø150
FV-35ZY1G	968	930	895	874	331	165,5	102	Ø145	Ø200	609	132,5	115	168	Ø150
FV-50ZY1G	968	1072	895	1016	331	165,5	114	Ø195	Ø250	665	175,5	115	168	Ø200
FV-65ZY1G	1008	1010	934	954	404	202	114	Ø195	Ø250	638	158	121	168	Ø200
FV-80ZY1G	1224	1060	1148	1004	404	202	122	Ø245	Ø300	633	185,5	121	168	Ø250
FV-1KZY1G	1224	1287	1148	1231	404	202	122	Ø245	Ø300	860	185,5	121	168	Ø250

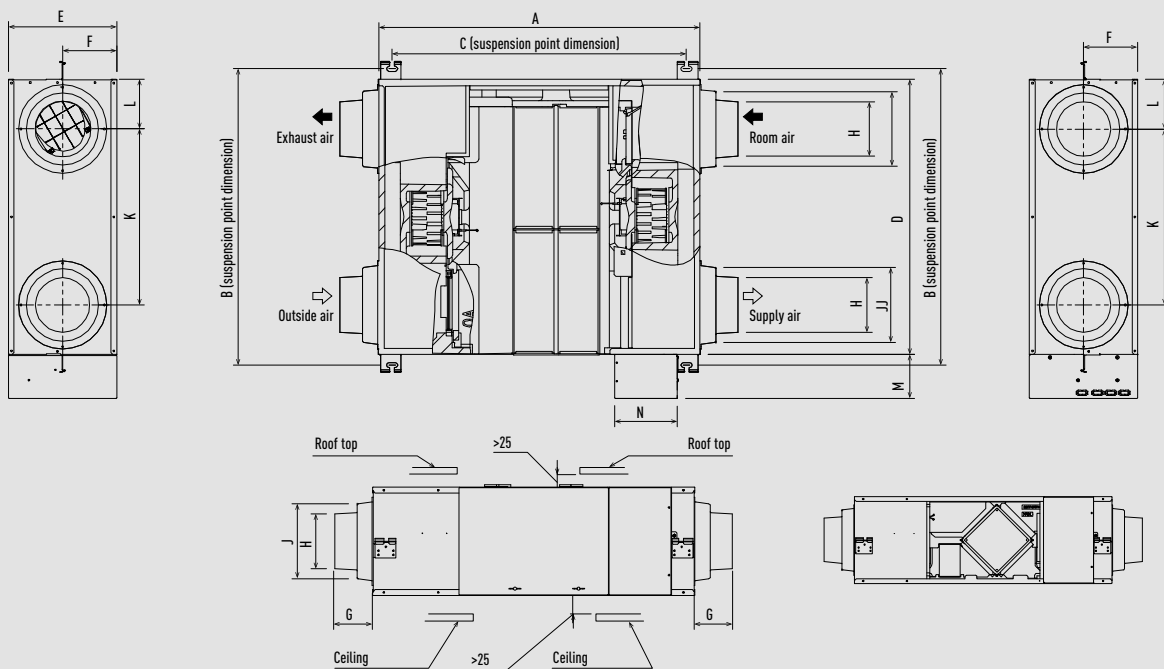

Unit: mm

Advanced energy recovery ventilation.

FV-1HZY1G / FV-2KZY1G

	A	B	C	D	E	F	G	H	J	K	L	M	N	Duct diameter
FV-1HZY1G	1224	1141	1127	1004	808	202	122	Ø245	Ø300	663	185.5	121	168	Ø250
FV-2KZY1G	1224	1368	1127	1231	808	202	122	Ø245	Ø300	860	185.5	121	168	Ø250

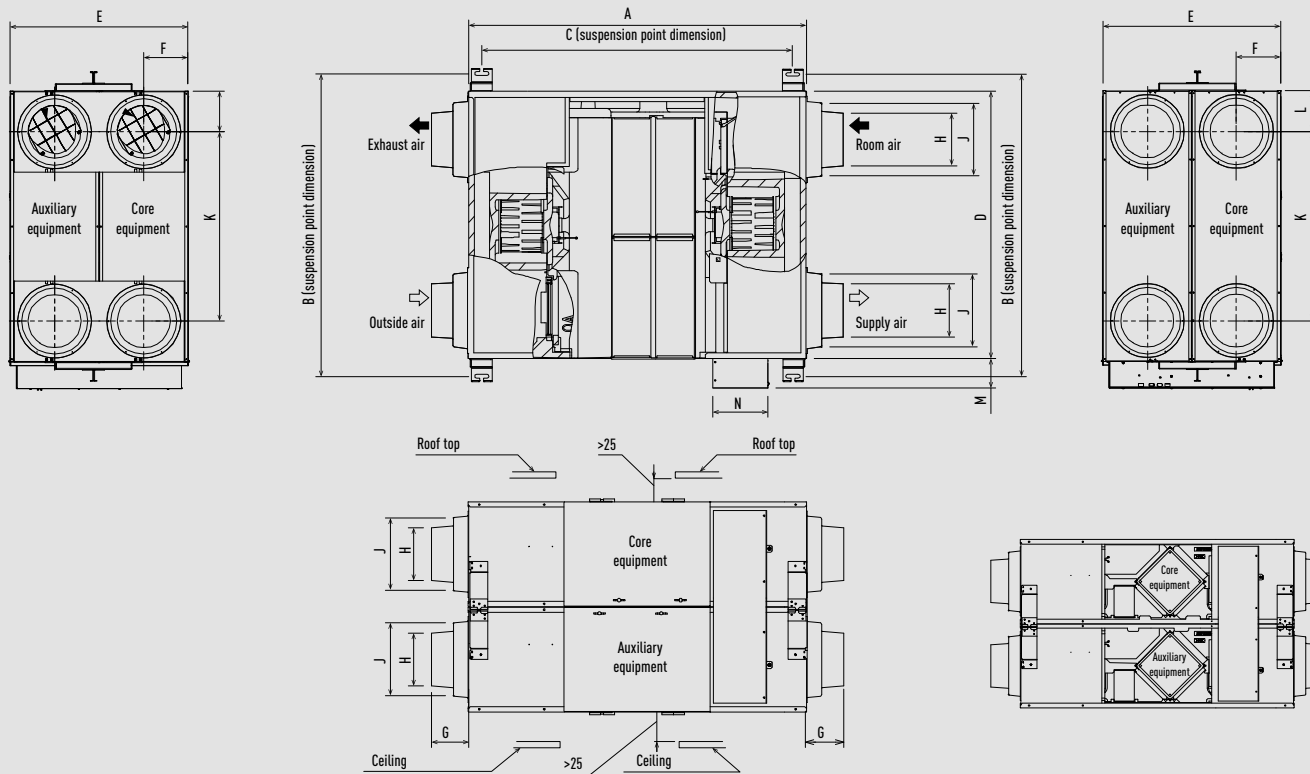

Unit: mm

Energy recovery ventilation.

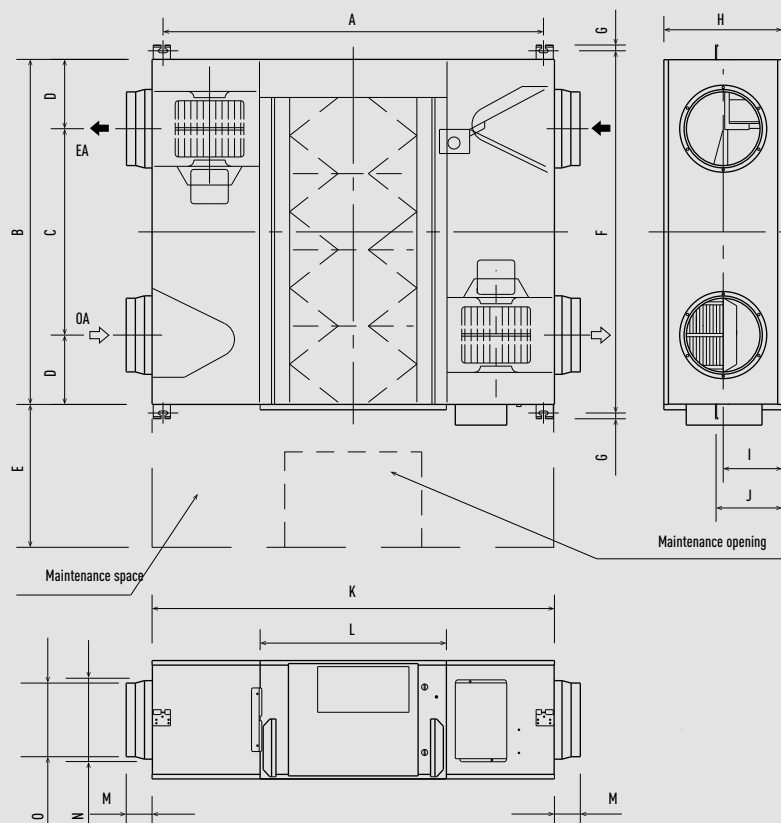

	FY-250ZDY8R	FY-350ZDY8R	FY-500ZDY8R	FY-800ZDY8R	FY-01KZDY8R
A	810	978	1018	1250	1250
B	599	804	904	884	1134
C	315	580	640	428	678
D	142	112	132	228	228
E	600	600	600	600	600
F	655	860	960	940	1190
G	19	19	19	19	19
H	270	317	317	388	388
I	135	159	159	194	194
J	159	182	182	218	218
K	882	1050	1090	1322	1322
L	414	470	470	612	612
M	95	70	70	85	85
N	164	164	210	258	258
O	144	144	194	242	242

Unit: mm

Heat recovery with DX coil.

	A	B	C	D	E	E1	F	F1	G	L	T	K	M	N	P	R	S	Y	Z	Net weight
PAW-500ZDX3N	904	1400	107	200	825	1395	960	830	19	955	500	135	270	350	135	135	202	350	135	90 - 98
PAW-800ZDX3N	1134	1745	85	250	1115	1735	1190	1060	19	1200	678	170	388	500	170	228	415	195	100 - 110	
PAW-01KZDX3N	1216	1700	85	250	1130	1700	1273	1140	19	1290	621	171	388	550	146	241	151	415	195	105 - 120

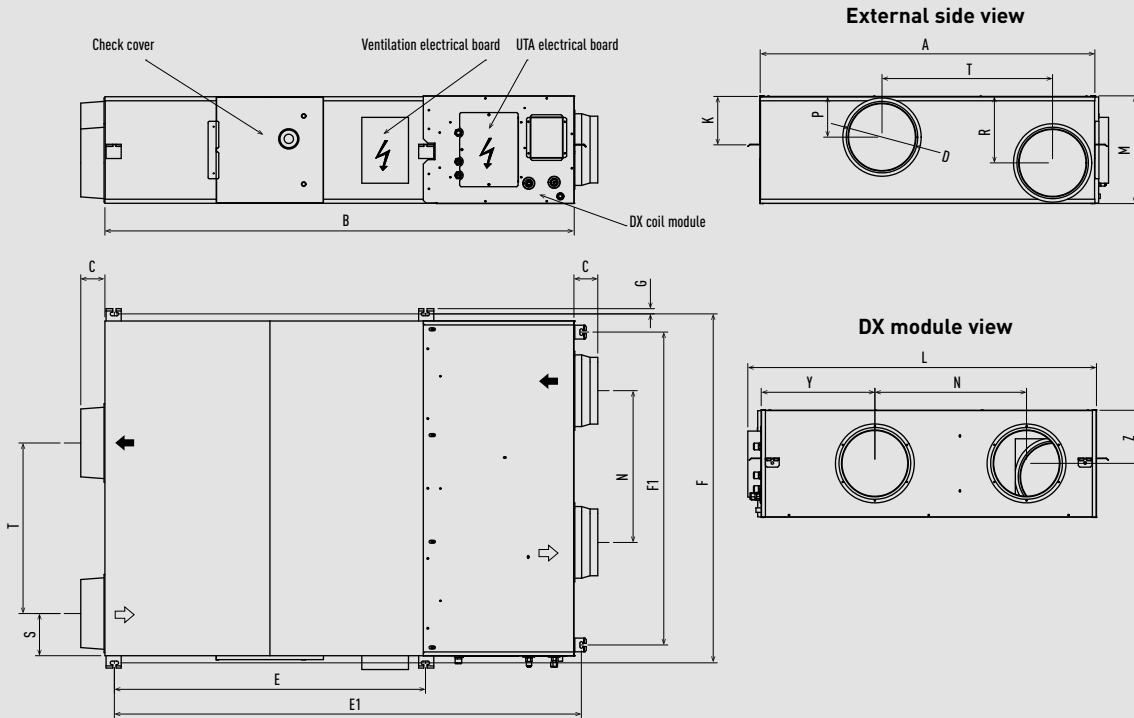

Unit: mm

Electric air curtain.

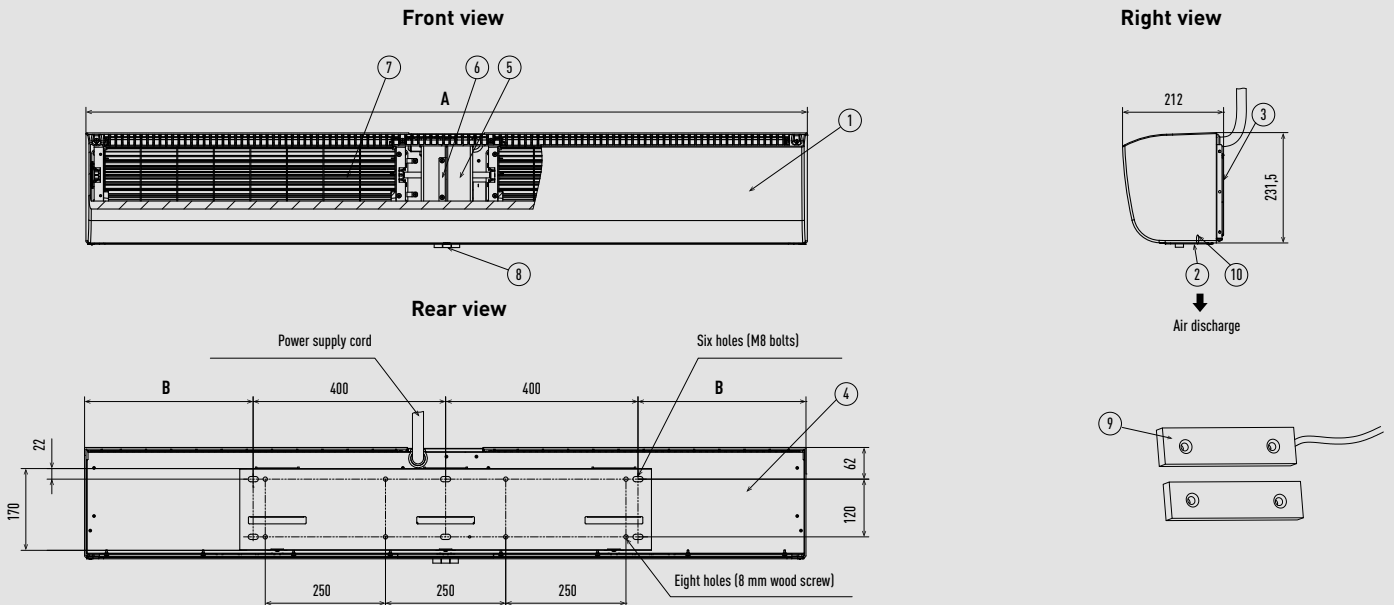

- 1 Front panel
- 2 Air discharge
- 3 Mounting plate
- 4 Back panel
- 5 Motor

- 6 Motor support
- 7 Cross-flow impeller
- 8 Push-button switch
- 9 Gate magnetic switch
- 10 Guide plate

	FY-3009U1	FY-3012U1	FY-3015U1
A	900	1200	1500
B	50	200	350

Unit: mm

Air curtain with DX coil.

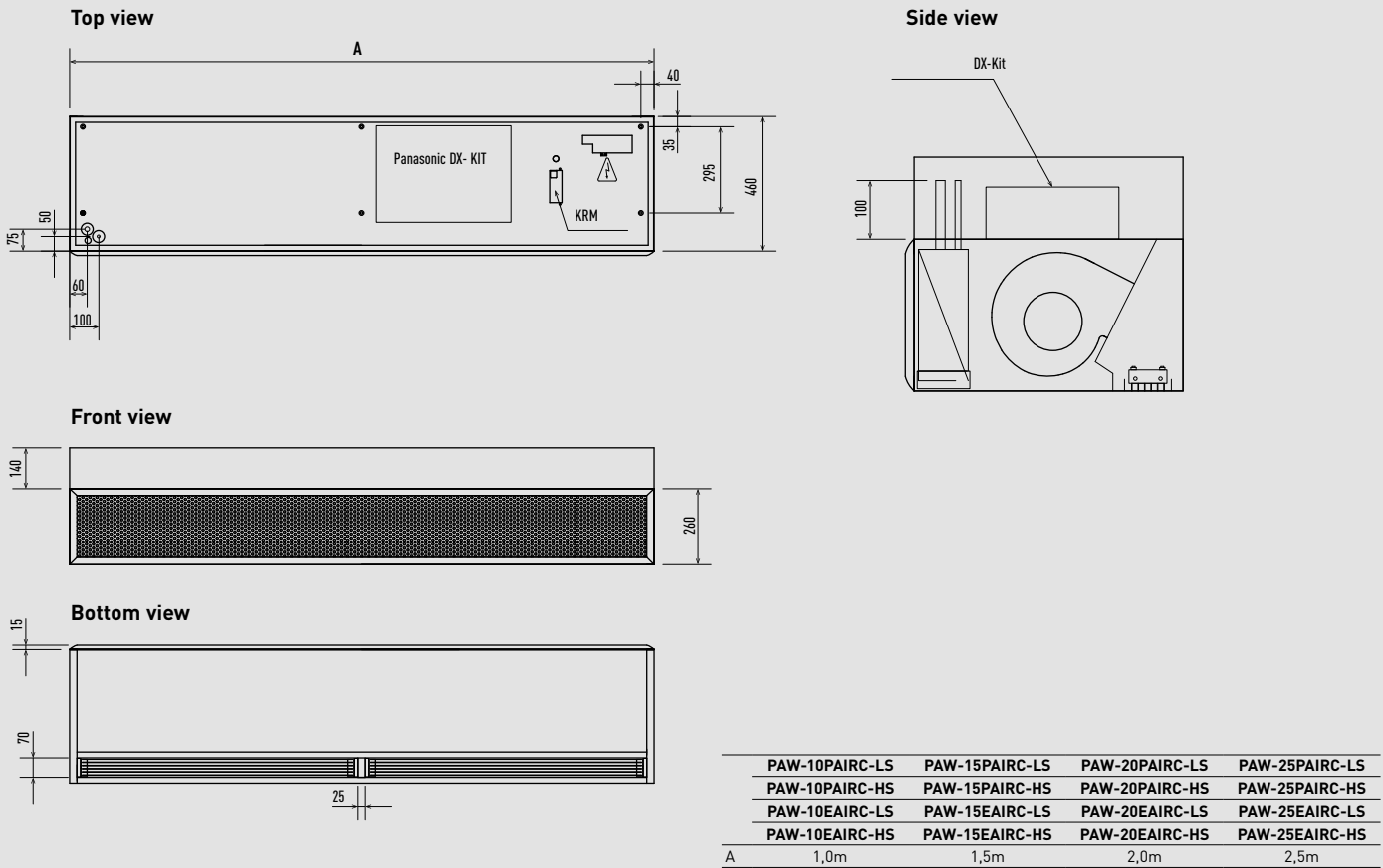

Unit: mm

E2 type high static pressure hide-away.

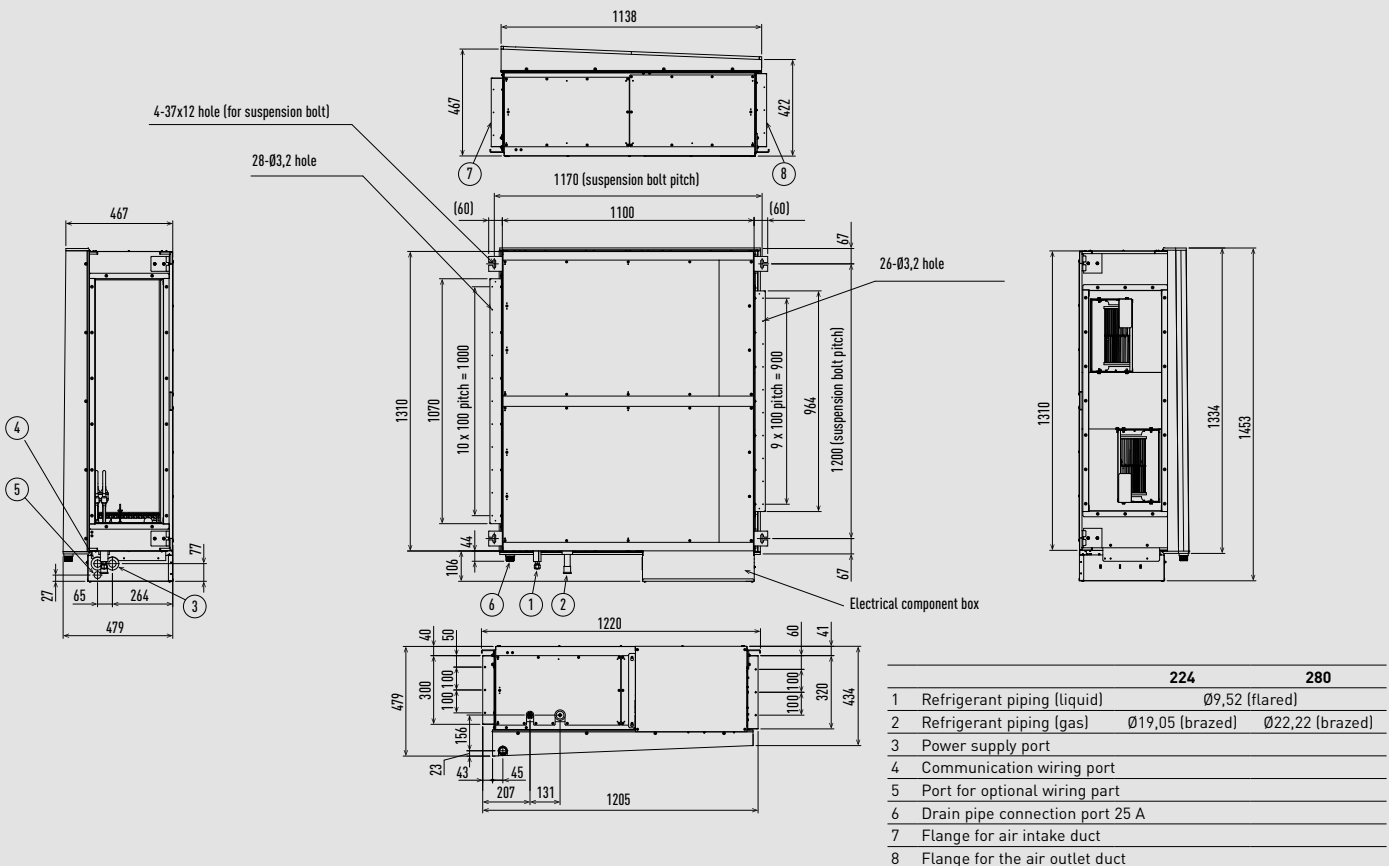

Unit: mm

Ceiling mounted air-e nanoe X Generator.

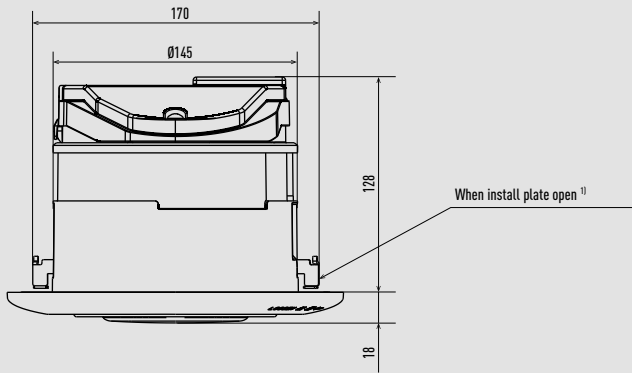

	Quantity
1 Louvre	1
2 Frame	1
3 Electric case assy	1
4 Motor	1
5 Fan	1
6 Orifice assy	1
7 nanoe™ X unit	1
8 Install screw	2
9 Install plate	2

1) Initial position of install plate is closed.

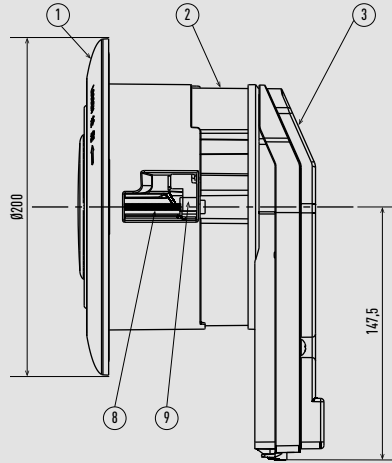
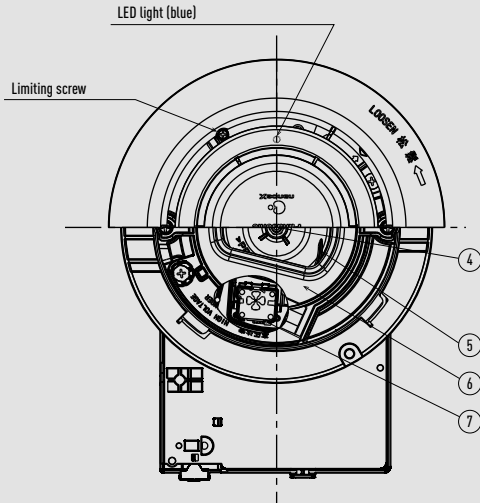

Unit: mm

Heat recovery ventilation unit.

Side view

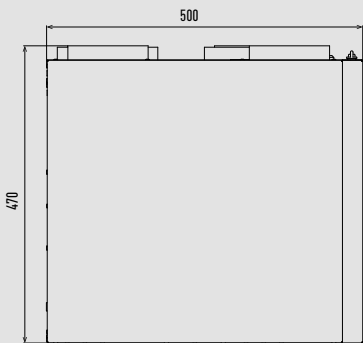

PAW-A2W-VENTA-L

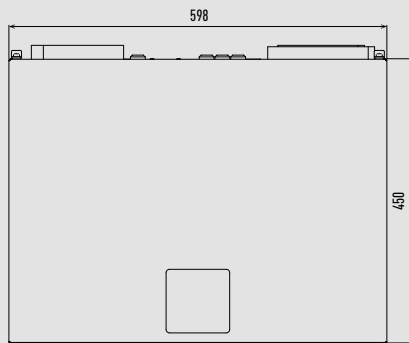

PAW-A2W-VENTA-R

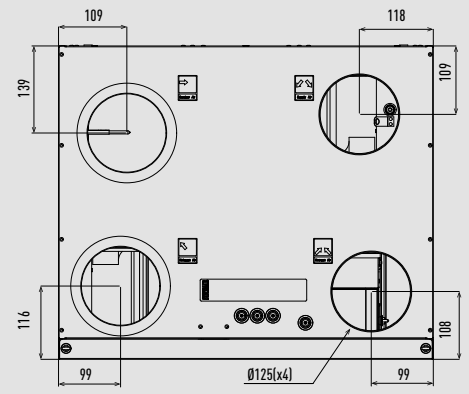
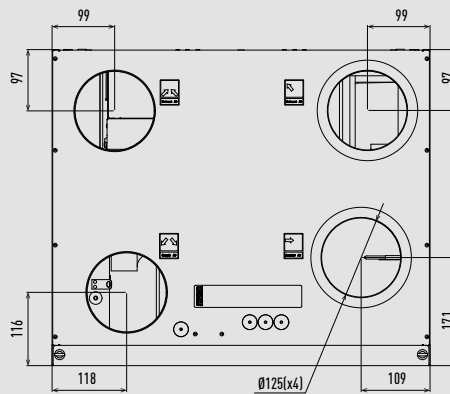
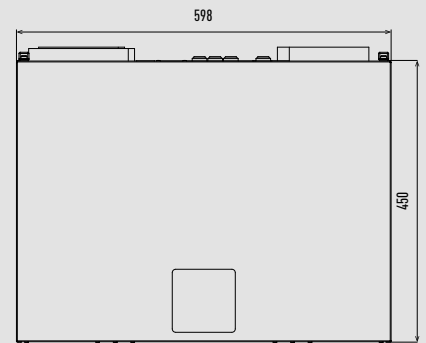

Unit: mm

Counter flow ventilation - PAW-VENTX10Z / PAW-VENTX15Z.

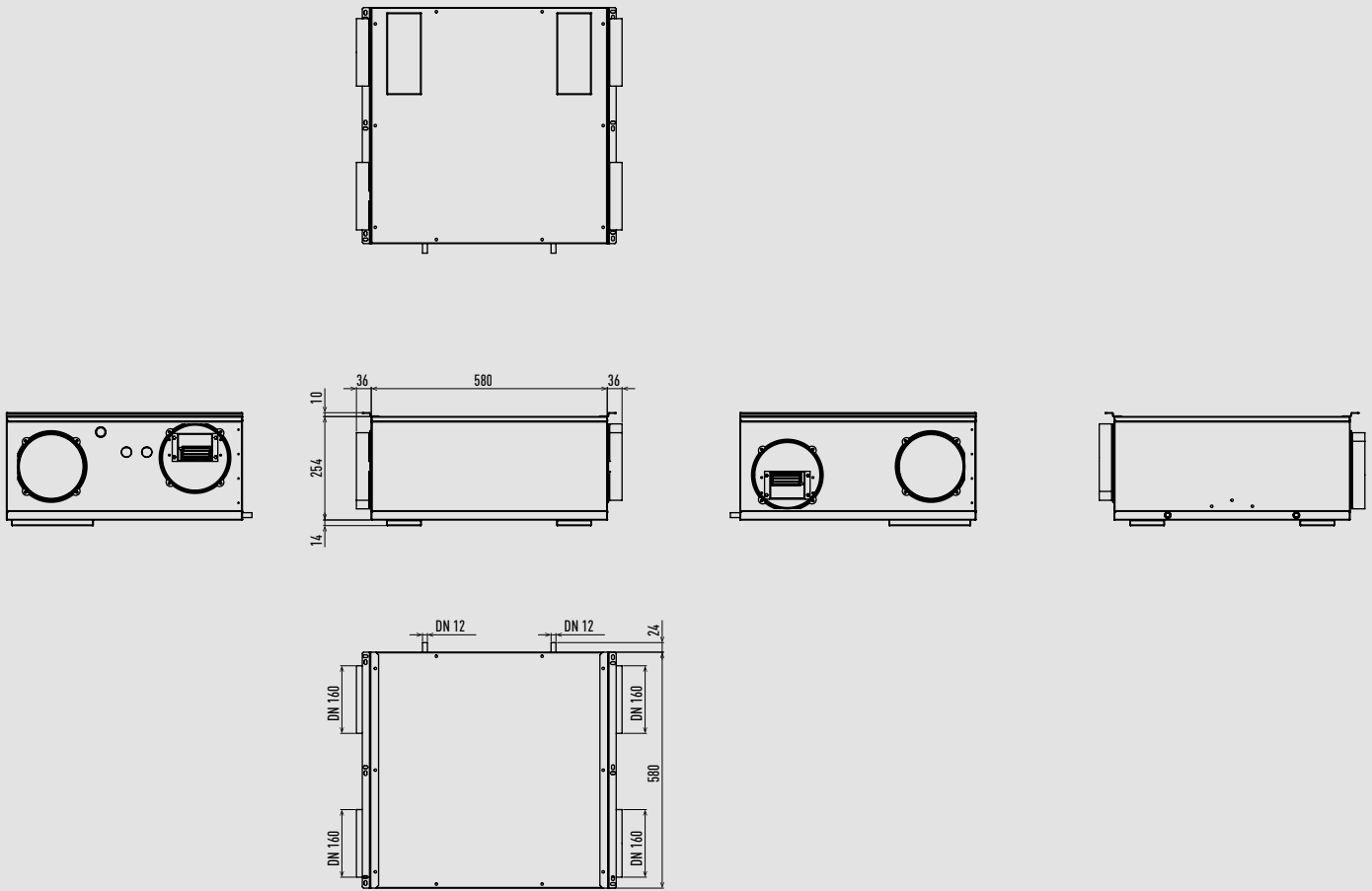

Unit: mm

Counter flow ventilation - PAW-VENTX20H / PAW-VENTX30H / PAW-VENTX40H.

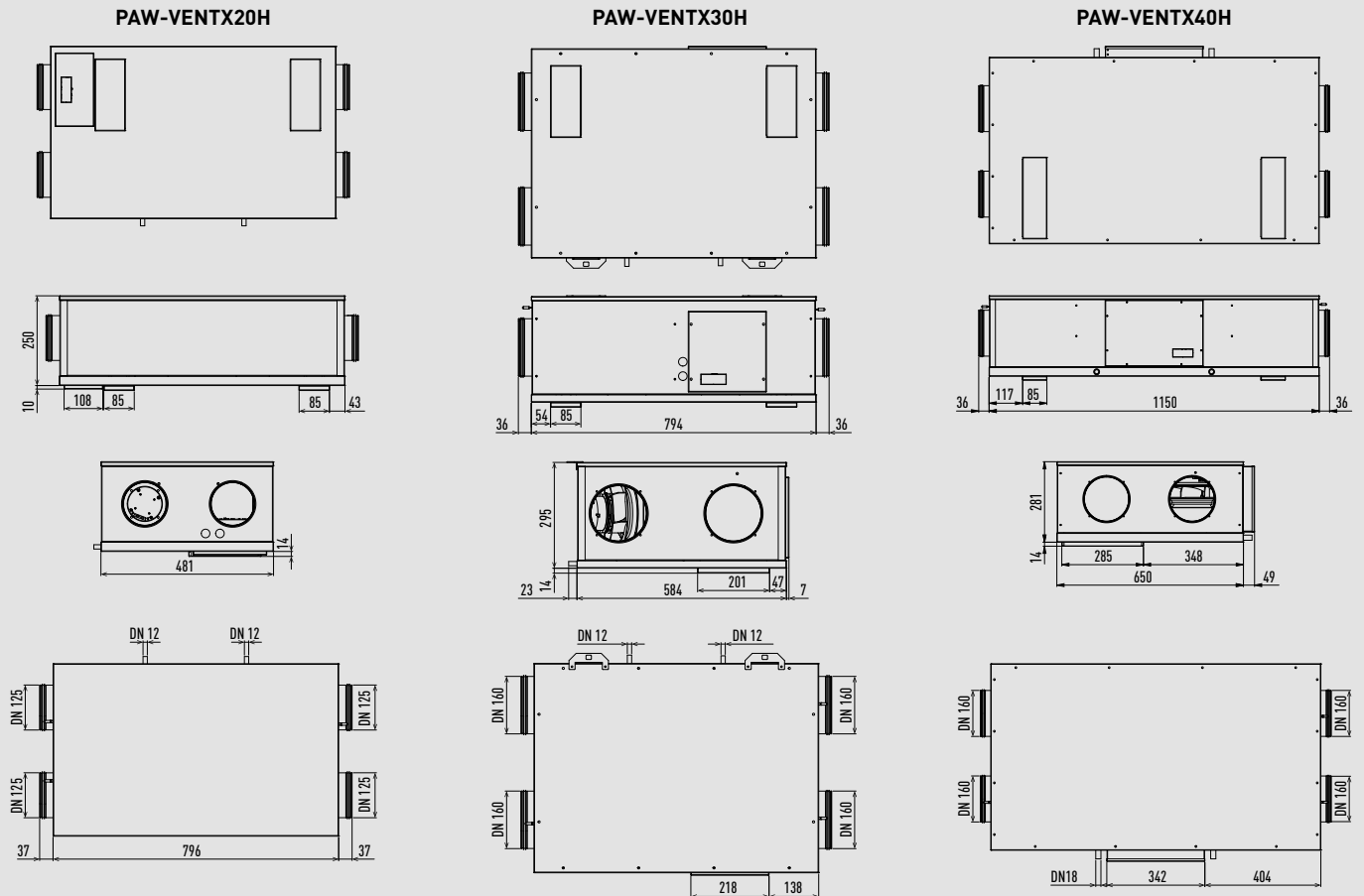

Unit: mm

Counter flow ventilation - PAW-VENTX20V / PAW-VENTX30V / PAW-VENTX40V.

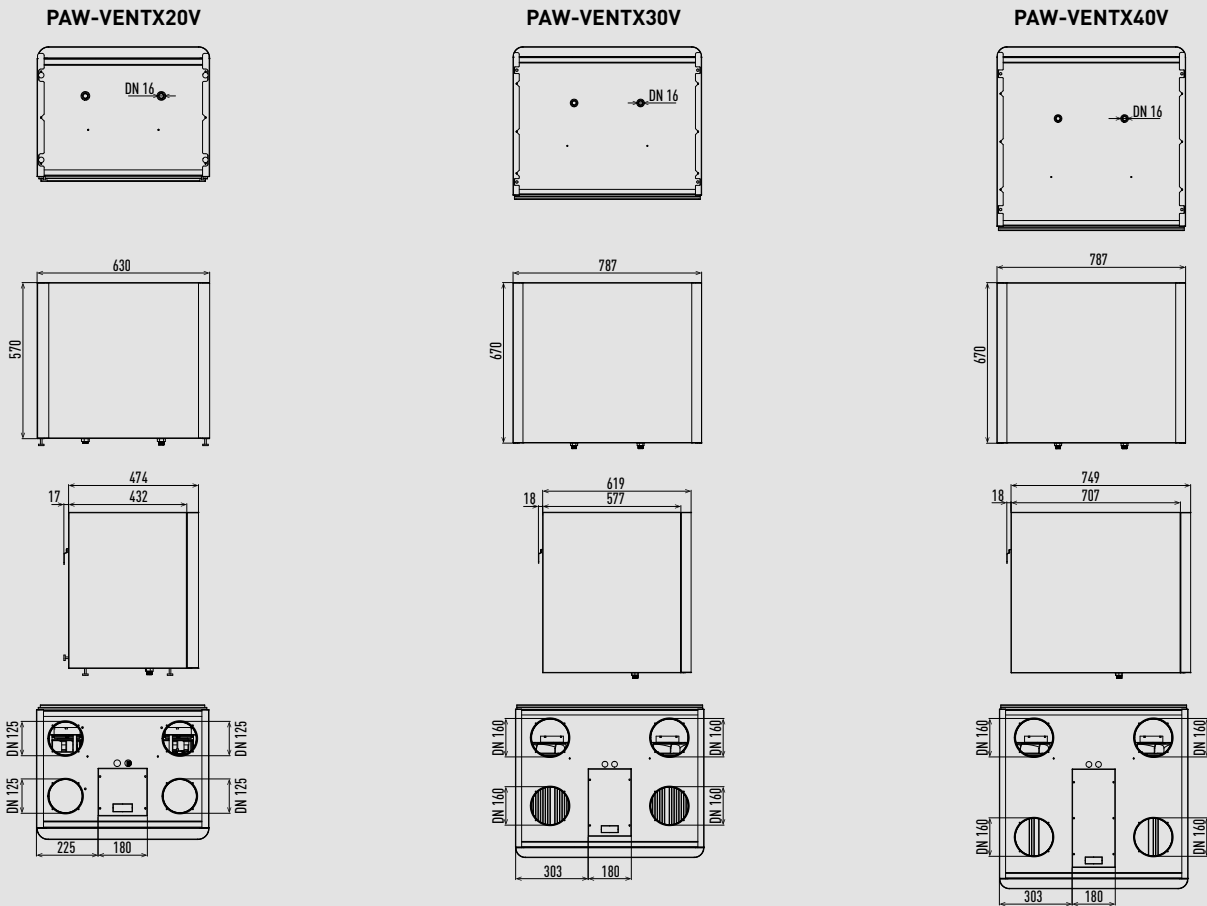

Unit: mm

Room controller for SE8000.

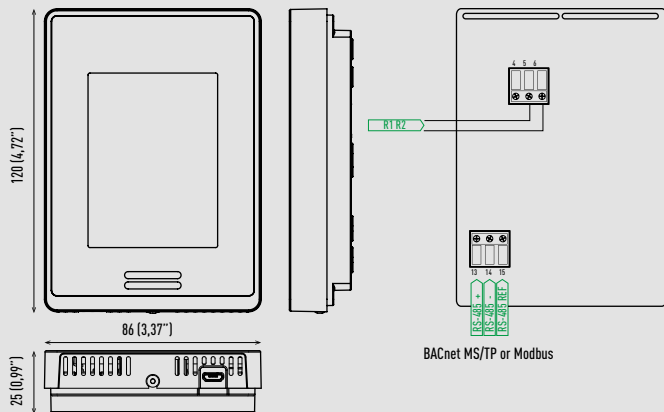

Dimensions:

Height: 12 cm/4,72 in.
Width: 8,6 cm/3,39 in.
Depth: 2,7 cm/1,06 in.

Power requirements:

16 Vdc from Panasonic R-R IDU connectors.
50/60 Hz, 4 VA, Class 2 Supply.

Range from indoor unit:

Recommended 500 ft (150 m).

Operating conditions:

0 °C to 50 °C (32 °F to 122 °F).
0% to 95% R.H. non-condensing.

Storage conditions:

-30 °C to 50 °C (-22 °F to 122 °F).
0% to 95% R.H. non-condensing.

Temperature sensor:

Local 10 K NTC type 2 thermistor.

Temperature sensor resolution:

± 0,1 °C (± 0,2 °F).

Temperature sensor accuracy:

± 0,5 °C (± 0,9 °F) @ 21 °C (70 °F) typical calibrated.

Humidity sensor and calibration:

Single point calibrated bulk polymer type sensor.

Humidity sensor precision:

Reading range from 10% to 90% R.H. non-condensing.
10% to 20% precision: 10%.
20% to 80% precision: 5%.
80% to 90% precision: 10%.

Humidity sensor stability:

Less than 1,0% yearly (typical drift).

Wiring:

Maximum wire length between last indoor unit to SER8150RxB1194 equals 490 ft (150 m) with AWG #18 wire (0,82 mm²). Refer to Panasonic VRF guidelines "Wiring system diagram for remote controller" for this limitation.

Approximate shipping weight:

0,34 kg (0,75 lb)

Check with your local government for instruction on disposal of these products.

THIS PRODUCT FOR COMMERCIAL USE ONLY.



Unit: mm

SED-MTH-G-5045 wall/ceiling wireless sensor.

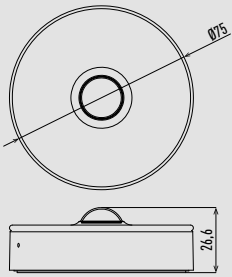

Dimensions:
70 mm diameter x 26,6 mm.

Colour:
White.

Weight:
59 g.

Communication:
ZigBee 3,0 HA.

Detection range:
Ceiling: Ø4m (installation height 2,5 m).
Wall: R5m (installation height 1,2 m).

Battery voltage:
3 V.

Battery cell:
LR03 AAA (2 pcs).

Battery life:
Up to 5 years.

Ambient temperature:
-10 °C ~ +50 °C.

Certification



Check with your local government for instruction on disposal of these products.

SED-WDC-G-5045 door/window wireless sensor.

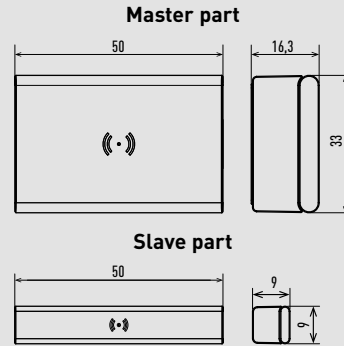

Dimensions:
Master part: 50 x 33 x 16,3 mm.
Slave part: 50 x 9 x 9 mm.

Colour:
White / transparent.

Weight:
30 g

Communication:
ZigBee 3,0 HA.

Detection range:
Trigger 'close': wood 30 mm, metal 18 mm.
Trigger 'open': wood 32 mm, metal 20 mm.

Battery voltage:
3 V.

Battery cell:
CR2450.

Battery life:
Up to 5 years.

Ambient temperature:
-10 °C ~ +50 °C.

Certification



Check with your local government for instruction on disposal of these products.

Unit: mm

SED-CO2-G-5045 CO₂ sensor.

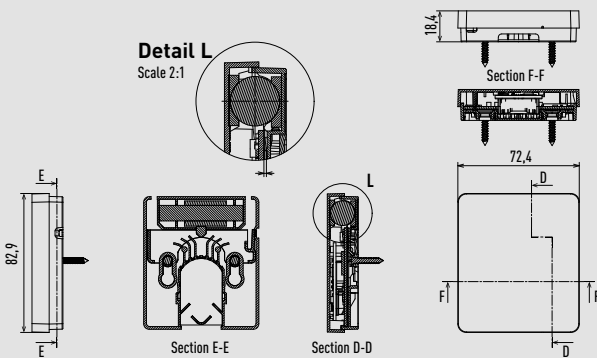

Dimensions:
3,26 x 2,85 x 0,72 inches.
82,9 x 72,4 x 18,4 mm.

Operating temperature:
0 °C to 50 °C (32 °F to 122 °F).

Temperature accuracy:
±0,3 °C (0,54 °F) typical within operating range.

Humidity range:
0% to 100%.

Humidity accuracy:
± 3% RH (typical within 0% to 80% RH).

Measurement range:
0 to 5000ppm.

Measurement/Transmission intervals:
2,5 minutes (day), 10 minutes (evening).
Note: Battery life will be reduced should interval be shortened (i.e, using remote temperature/humidity functions).

CO₂ accuracy at NTP:
±60 ppm +3% of reading (400 - 2,000 ppm range).

Communication:
Zigbee 3,0 Green Power (encrypted, bi-directional).

Battery voltage:
3,6 V.

Battery cell:
AA Lithium ion.

Battery life:
10+ years (non-replaceable).
Note: Battery life can be reduced when sensor is operated at temperatures approaching the operating limits.

Ambient temperature:
-30 °C to 70 °C.

Certification



Check with your local government for instruction on disposal of these products.

Unit: mm

Hotel room controller (HRC).

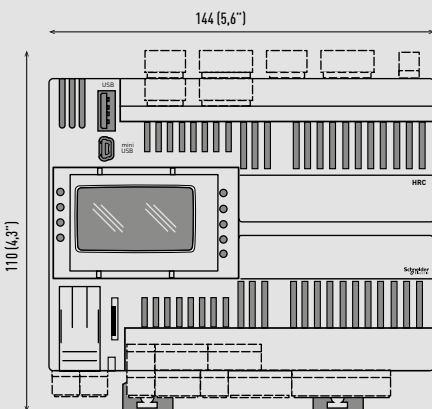

Dimensions:
5,6 x 4,3 x 2,4 inches.
144 x 110 x 60,5 mm.

Digital inputs:
12.

High voltage relay digital outputs:
10 x 3 A SPST +250 VAC relays.

Analog inputs:
2 x configurable analog inputs.
DI: voltage free DI, 10 kΩ input impedance.
0-20 mA: range 0,1000, < 150 Ω impedance.
0-10 V: range 0,1000 > 10 kΩ impedance.

Analog outputs:
6 x 0-10 V outputs,
load impedance > 700 Ω.

Supply voltage:
24 VAC + 10% NOT ISOLATED.
+20...38 Vdc NOT ISOLATED.

Supply frequency:
50/60 Hz.

Power cycle:
35 VA / 15 W.

Operating temperature:
-20 to 60 °C (-4 to 140 °F) conforming to UL 60730-1.

Storage temperature:
-30 to 70 °C (-22 to 158 °F).

* Power supply is not included.

Certification



Check with your local government for instruction on disposal of these products.

CZ-CAPWFC1 Commercial Wi-Fi Adaptor.

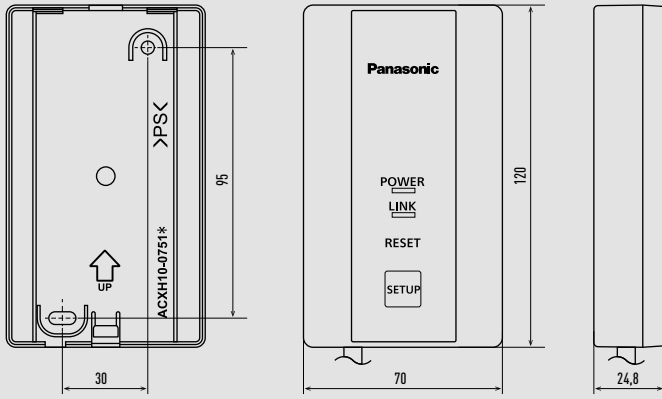

CZ-RTC6W/WBL/WBLW and CZ-RTC6/BL/BLW CONEX wired remote controller.

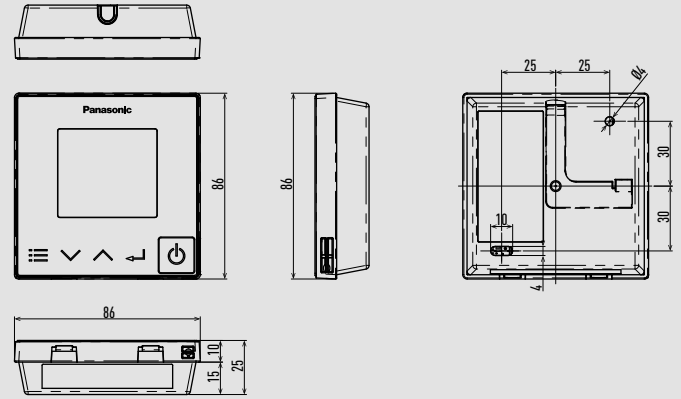

CZ-RTC5B design wired remote controller.

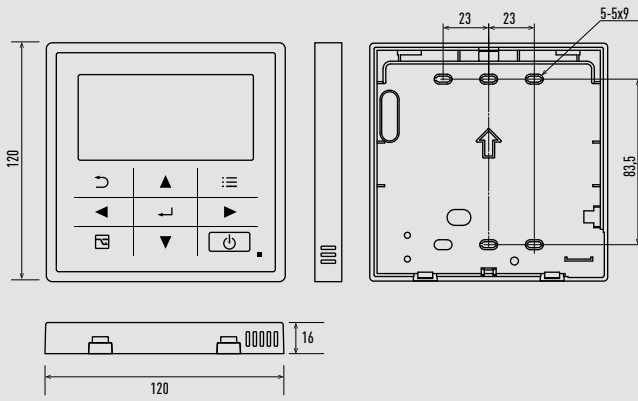

CZ-256ESMC3 intelligent controller (touch screen/web.server).

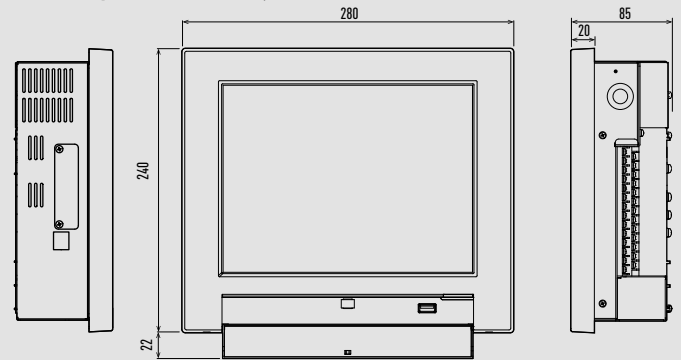

CZ-CENSC1 Econavi sensor.

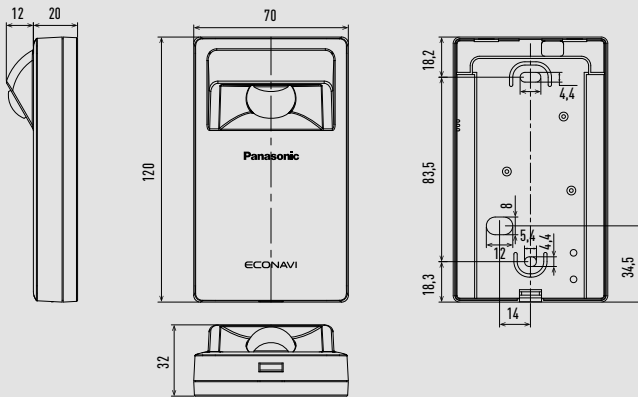

CZ-RWS3 infrared remote controller.

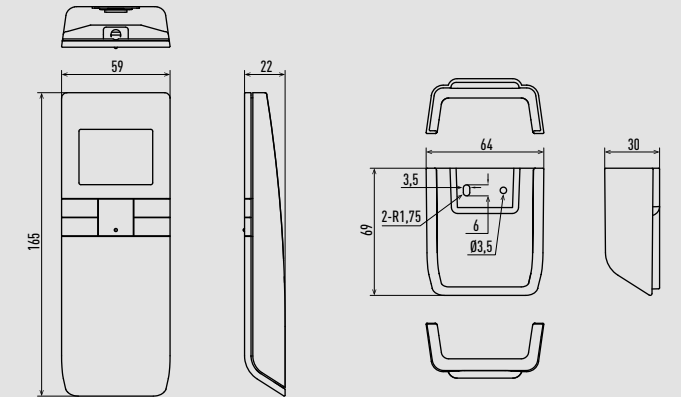

CZ-CSRC3 remote sensor.

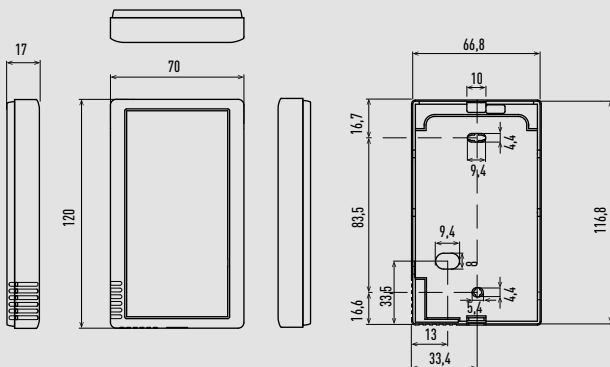

CZ-64ESMC3 system controller with weekly timer.

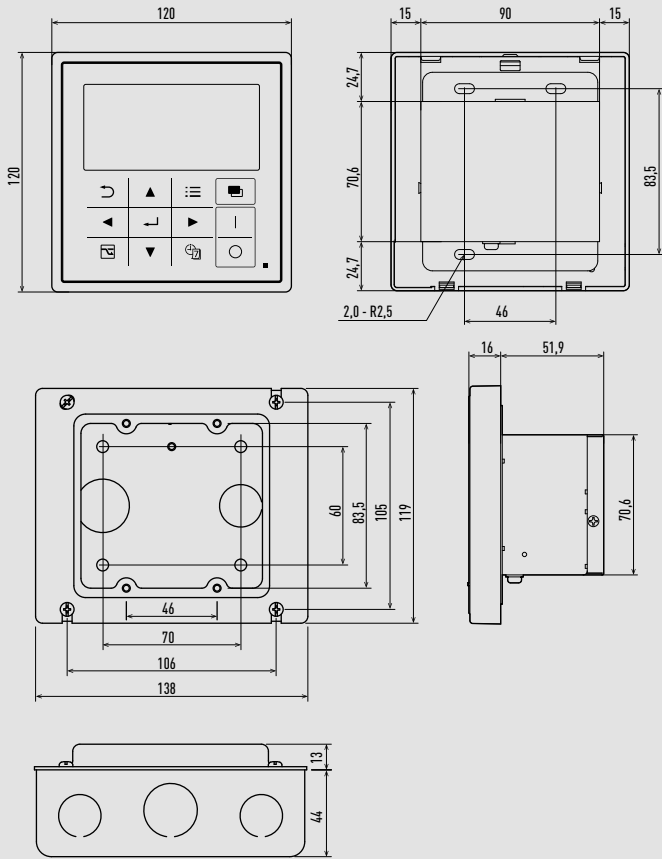

CZ-ANC3 central ON/OFF controller.

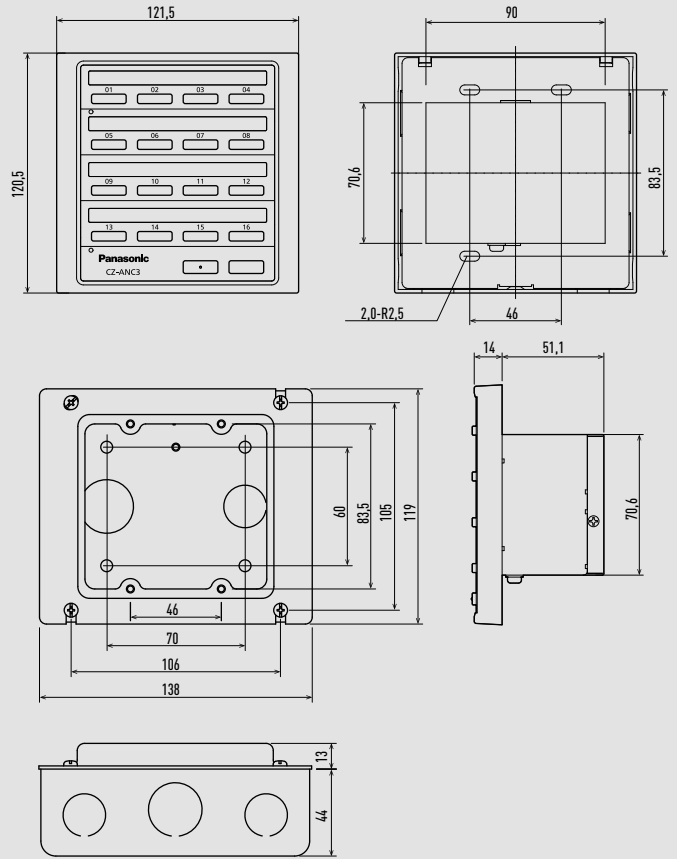

CZ-CAPC3 local adaptor for ON/OFF control.

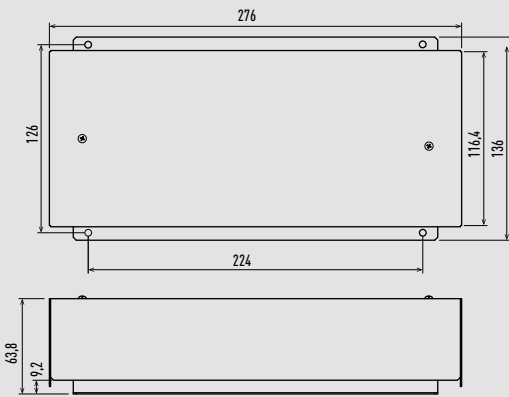

CZ-CAPBC2 Mini Seri-Para I/O Unit 0 - 10 V.

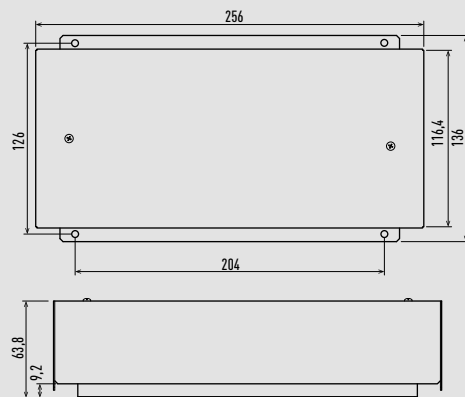

CZ-CFUNC2 communication adaptor.

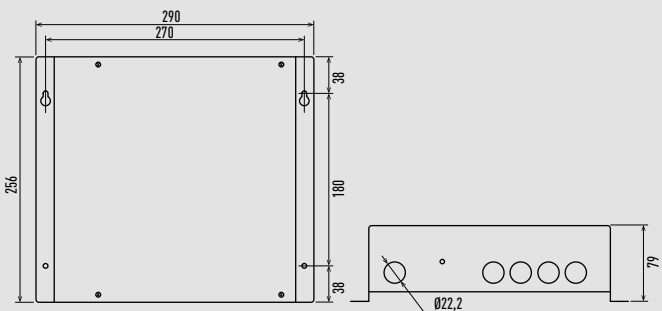

ECOi-W 50 to 60 - R32.

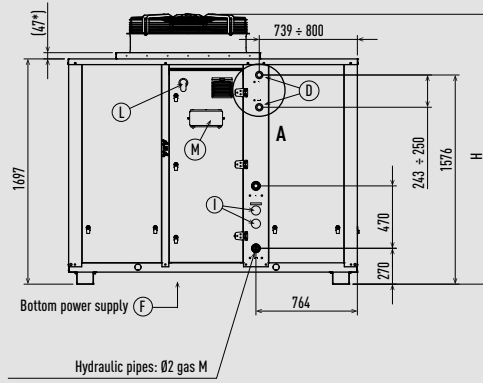
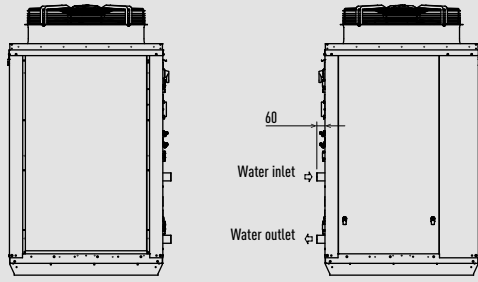

Detailed view A

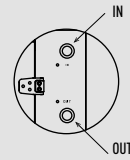

Desuperheater pipes connection: Ø1 ¼ gas M.

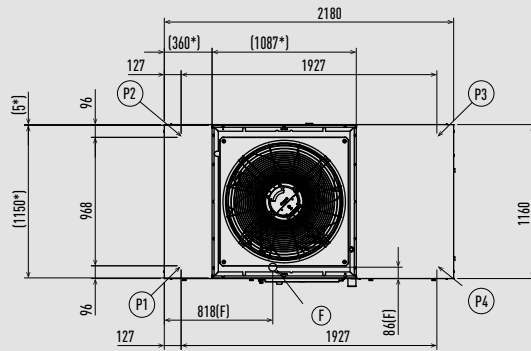
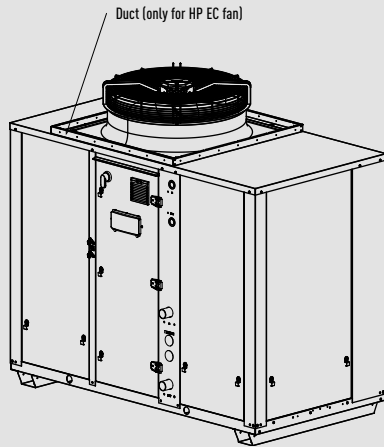

F	Electrical power supply
I	Gauge kit (optional)
L	Main switch
M	Control keypad / display
D	Desuperheater (optional)
S	Safety valve discharge
P1/P2/ P3/P4	AVM position (optional)

Fan	H (mm)
AC	1986
EC	2034
HP EC	2034

* Duct - only for high pressure EC fan model.

Unit: mm

ECOi-W 50 to 60 with buffer tank - R32.

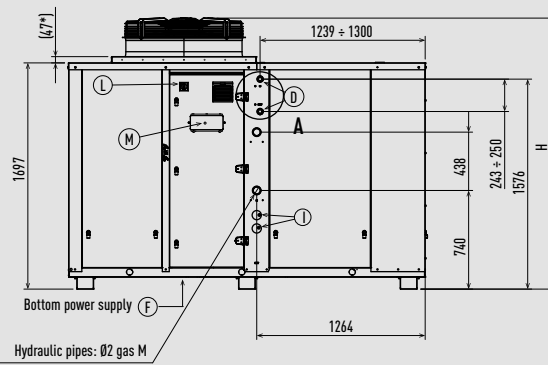
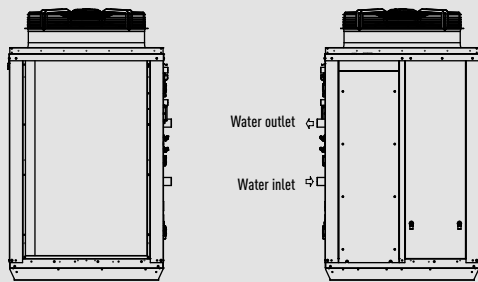

Detailed view A

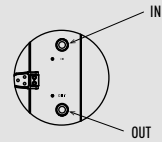

Desuperheater pipes connection: Ø1 ¼ gas M.

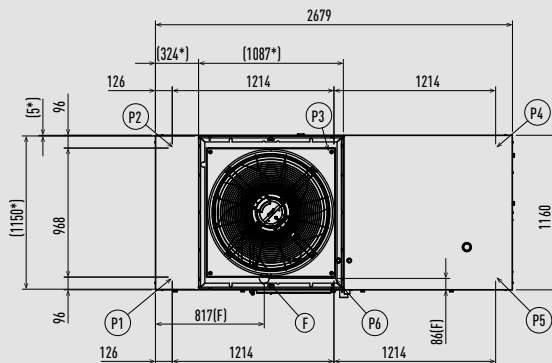
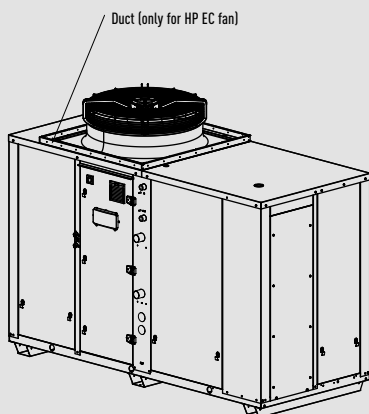

F	Electrical power supply
I	Gauge kit (optional)
L	Main switch
M	Control keypad / display
D	Desuperheater (optional)
S	Safety valve discharge
P1/P2/ P3/P4	AVM position (optional)

Fan	H (mm)
AC	1986
EC	2034
HP EC	2034

* Duct - only for high pressure EC fan model.

Unit: mm

ECOi-W 70 to 75 · R32.

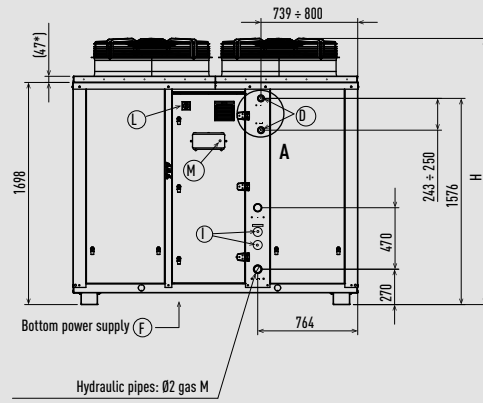
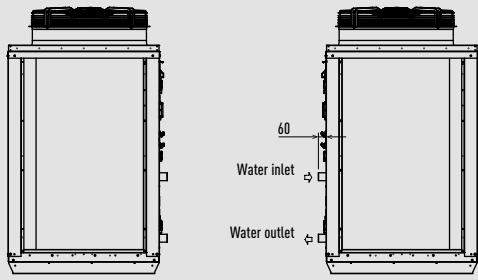

Detailed view A

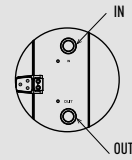

Desuperheater pipes connection: Ø1 ¼ gas M.

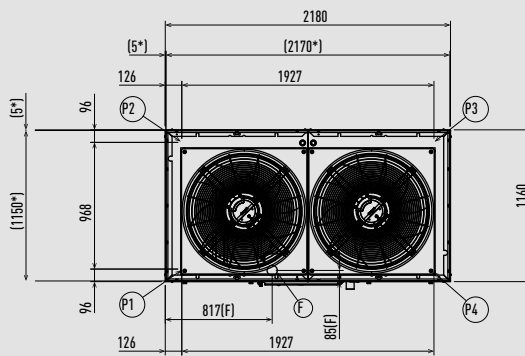
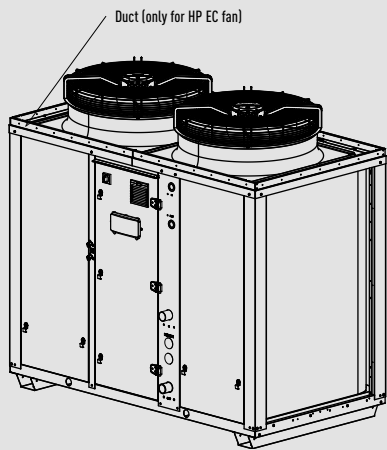

F	Electrical power supply
I	Gauge kit (optional)
L	Main switch
M	Control keypad / display
D	Desuperheater (optional)
S	Safety valve discharge
P1/P2/ P3/P4	AVM position (optional)

Fan	H (mm)
AC	1986
EC	2034
HP EC	2034

* Duct - only for high pressure EC fan model.

Unit: mm

ECOi-W 70 to 75 with buffer tank · R32.

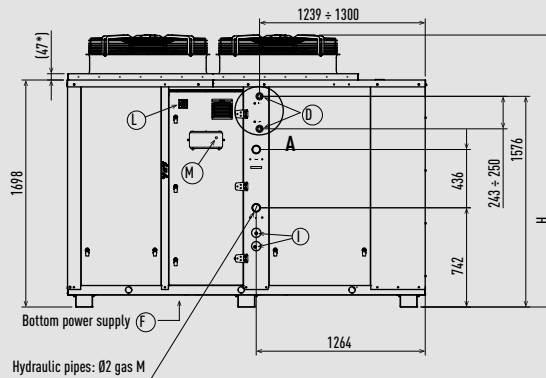
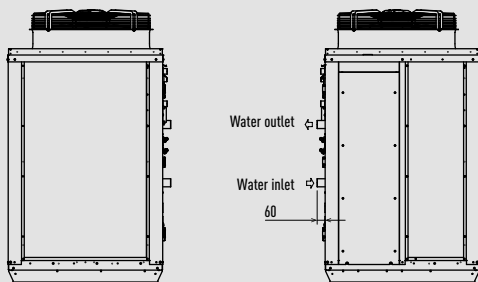

Detailed view A

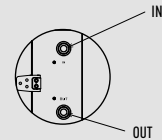

Desuperheater pipes connection: Ø1 ¼ gas M.

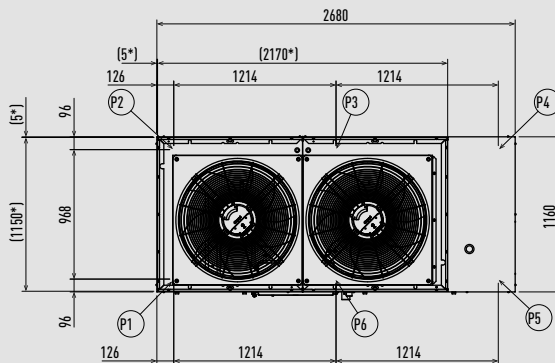
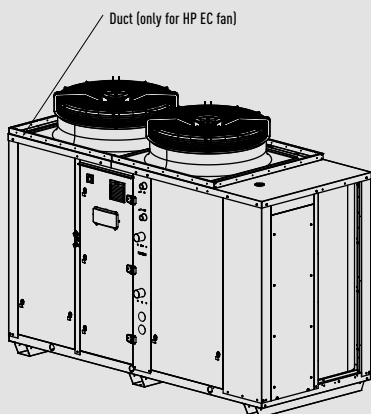

F	Electrical power supply
I	Gauge kit (optional)
L	Main switch
M	Control keypad / display
D	Desuperheater (optional)
S	Safety valve discharge
P1/P2/ P3/P4	AVM position (optional)

Fan	H (mm)
AC	1986
EC	2034
HP EC	2034

* Duct - only for high pressure EC fan model.

Unit: mm

ECOi-W 85 to 130 - R32.

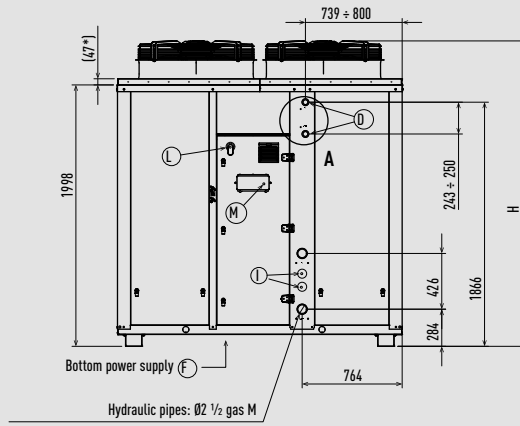
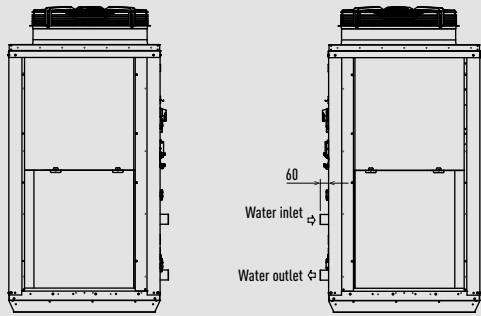

Detailed view A

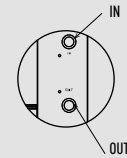

Desuperheater pipes connection: Ø1 1/4 gas M.

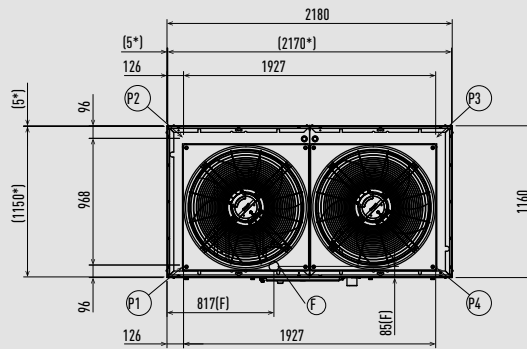
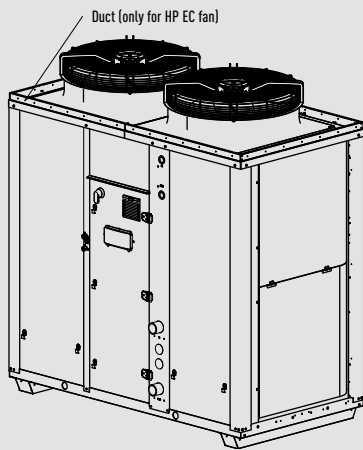

F	Electrical power supply
I	Gauge kit (optional)
L	Main switch
M	Control keypad / display
D	Desuperheater (optional)
S	Safety valve discharge
P1/P2/ P3/P4	AVM position (optional)

Fan	H (mm)
AC	2286
EC	2334
HP EC	2334

* Duct - only for high pressure EC fan model.

Unit: mm

ECOi-W 85 to 130 with buffer tank - R32.

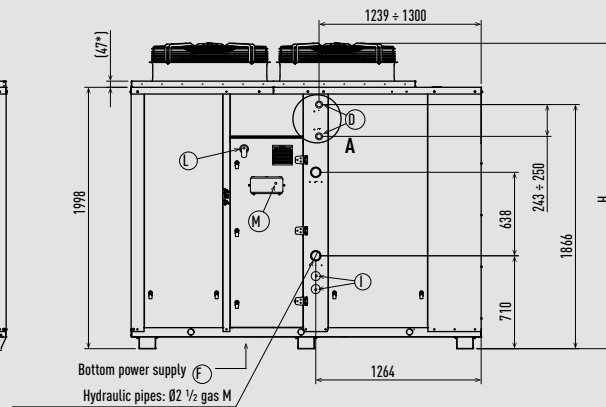
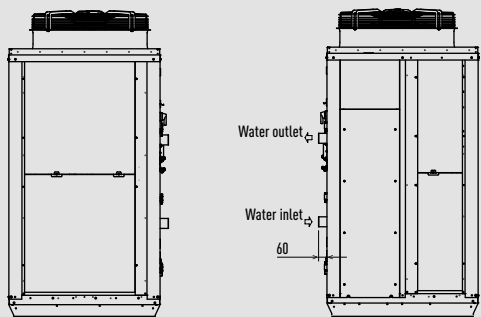

Detailed view A

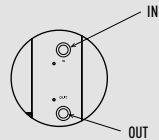

Desuperheater pipes connection: Ø1 1/4 gas M.

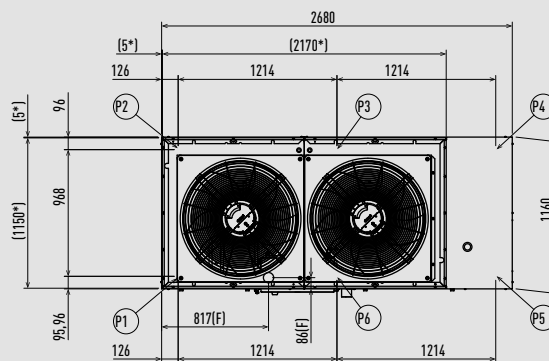
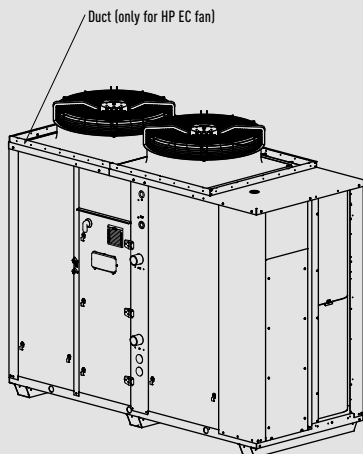

F	Electrical power supply
I	Gauge kit (optional)
L	Main switch
M	Control keypad / display
D	Desuperheater (optional)
S	Safety valve discharge
P1/P2/ P3/P4	AVM position (optional)

Fan	H (mm)
AC	2286
EC	2334
HP EC	2334

* Duct - only for high pressure EC fan model.

Unit: mm

ECOi-W 150 to 170 · R32.

F	Electrical power supply
I	Gauge kit (optional)
L	Main switch
M	Control keypad / display
D	Desuperheater (optional)
S	Safety valve discharge
P1/P2/ P3/P4	AVM position (optional)

Fan	H (mm)
AC	2310
EC	2370
HP EC	2370

* Duct - only for high pressure EC fan model.

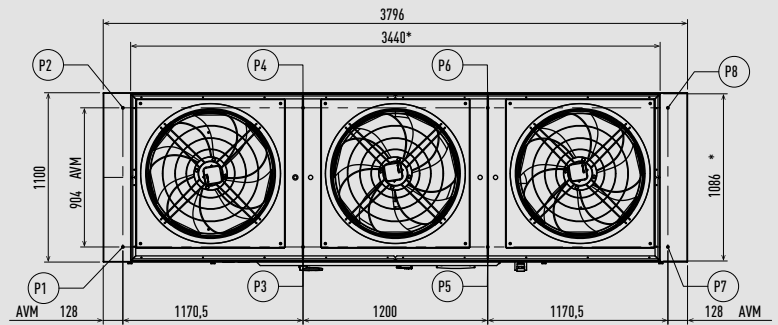
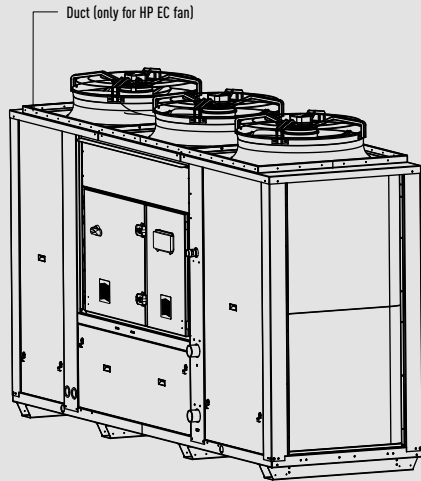
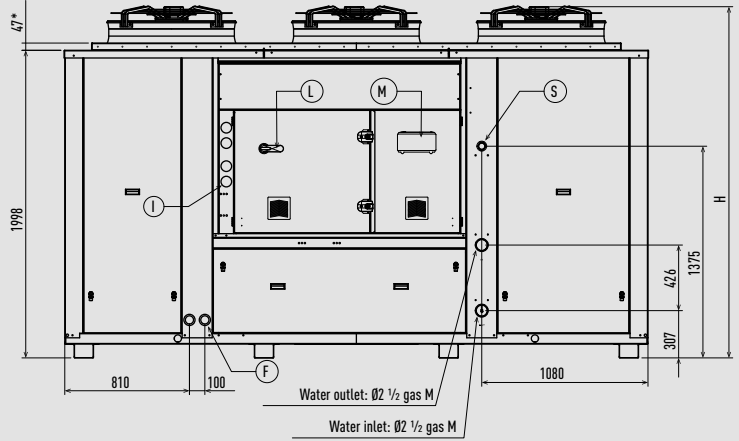
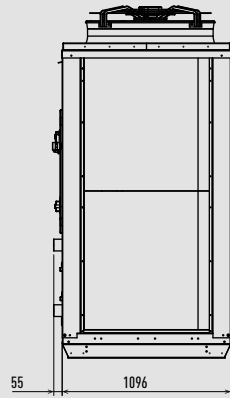

Unit: mm

ECOi-W 20 to 40 with condenser fans standard - R410A.

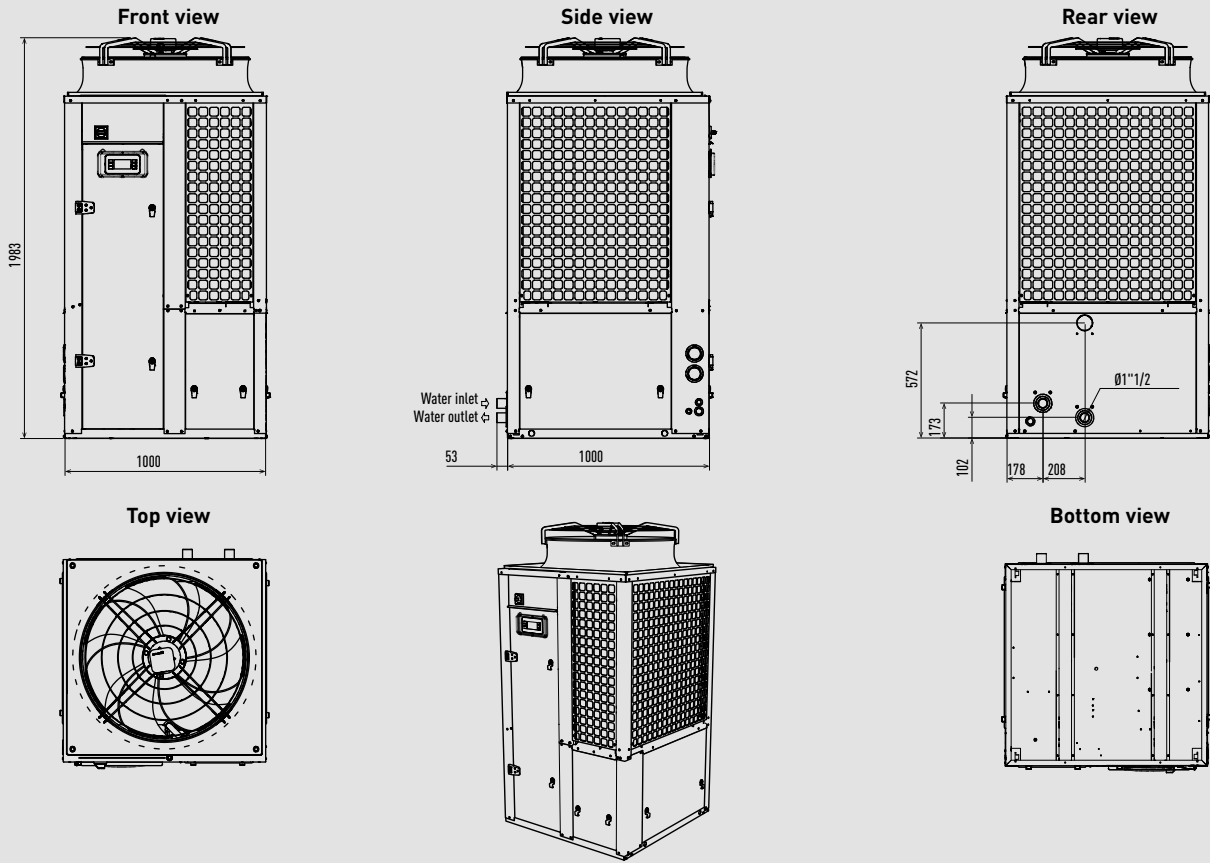

ECOi-W 20 to 40 with condenser fans standard and buffer tank - R410A.

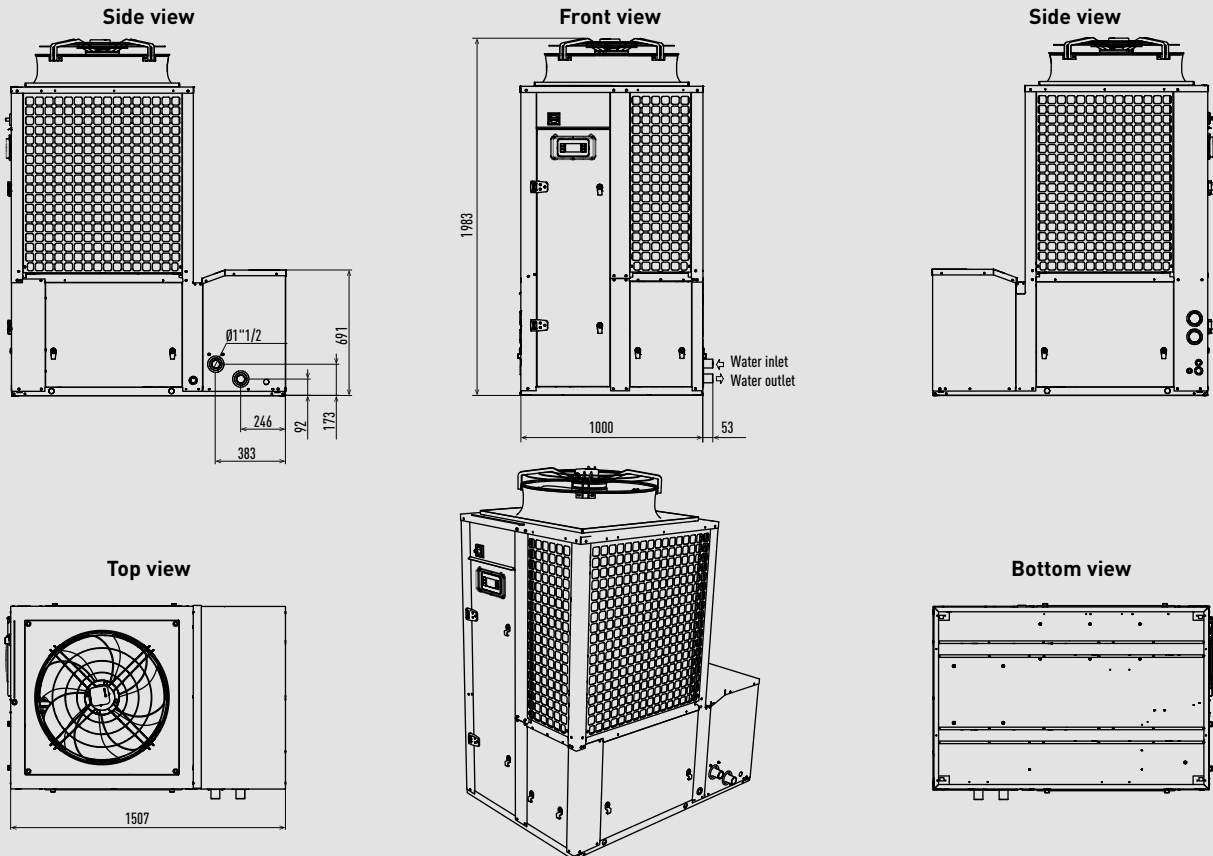

Unit: mm

Unit: mm

ECOi-W 140 to 210 without pump - R410A.

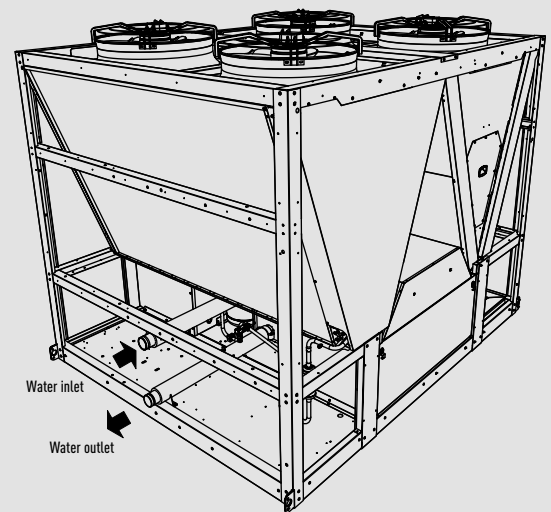
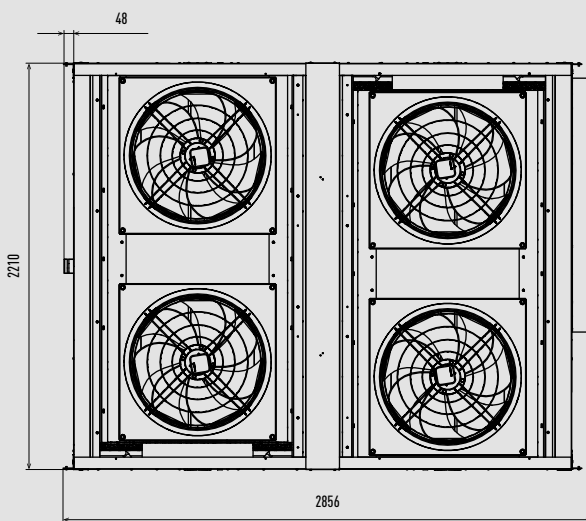
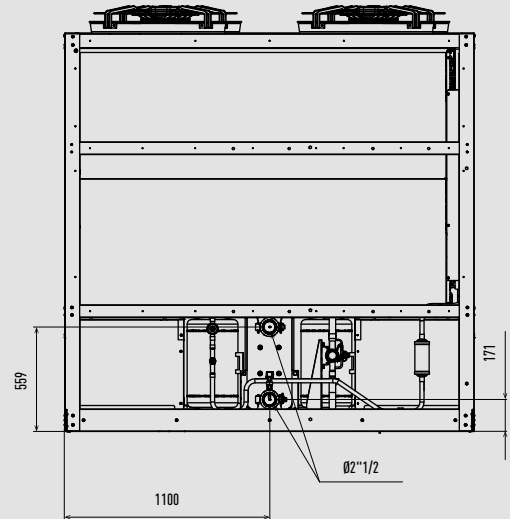
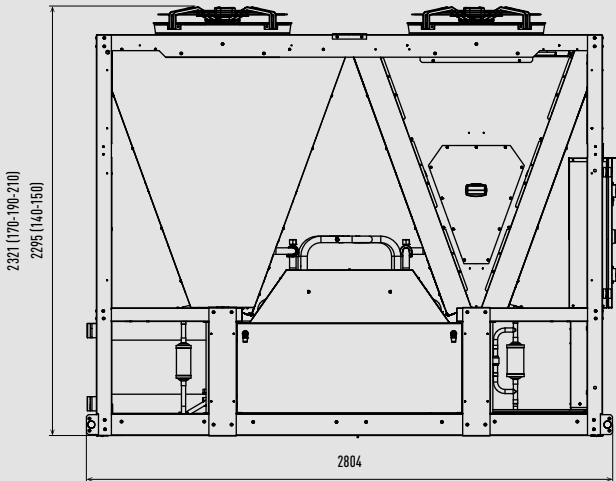
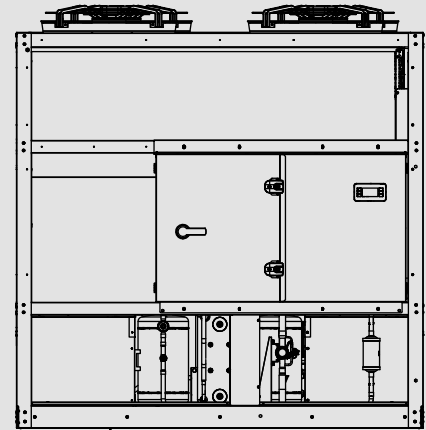
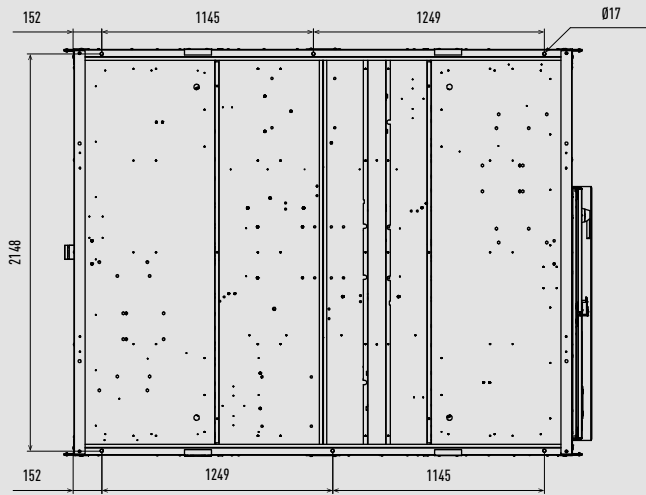

Unit: mm

ECOi-W 140 to 210 with 1 pump and buffer tank - R410A.

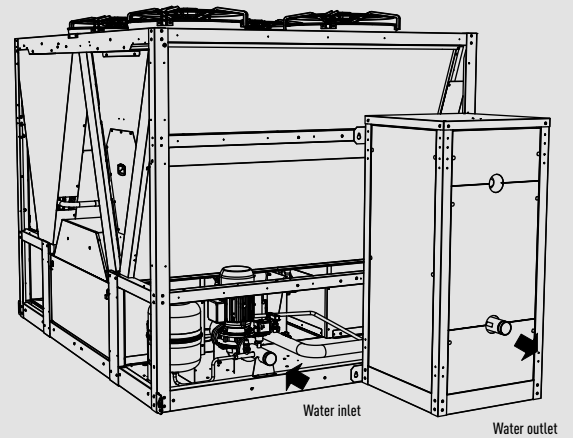
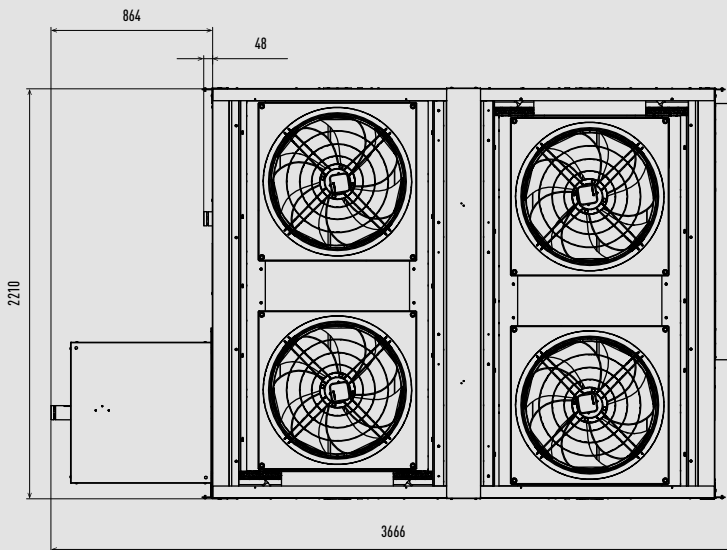
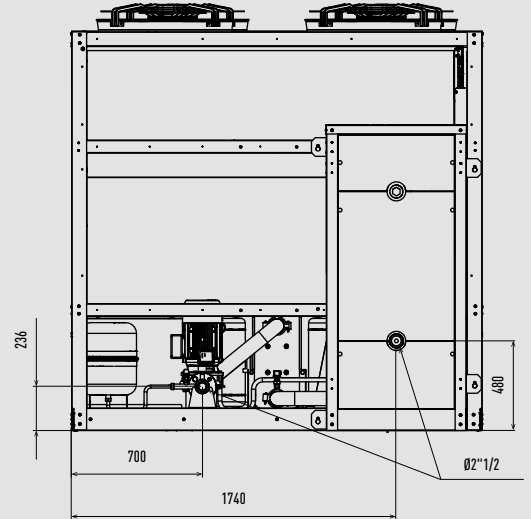
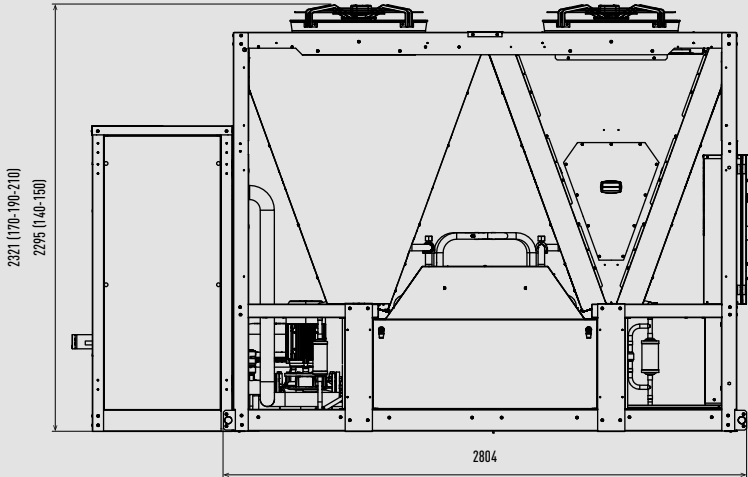
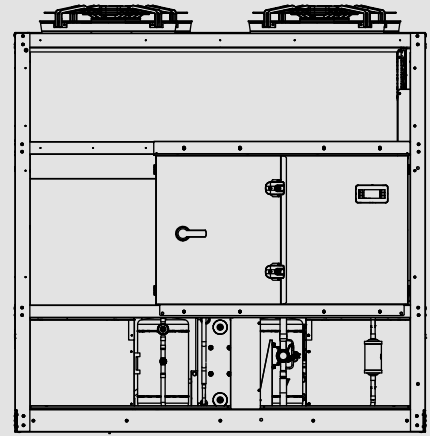
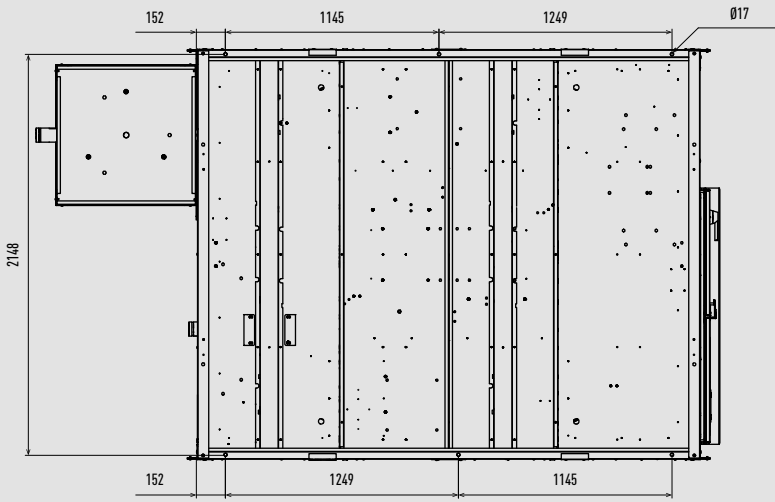

Condensing units - CR Series OCU-CR200VF5A / OCU-CR200VF5ASL.

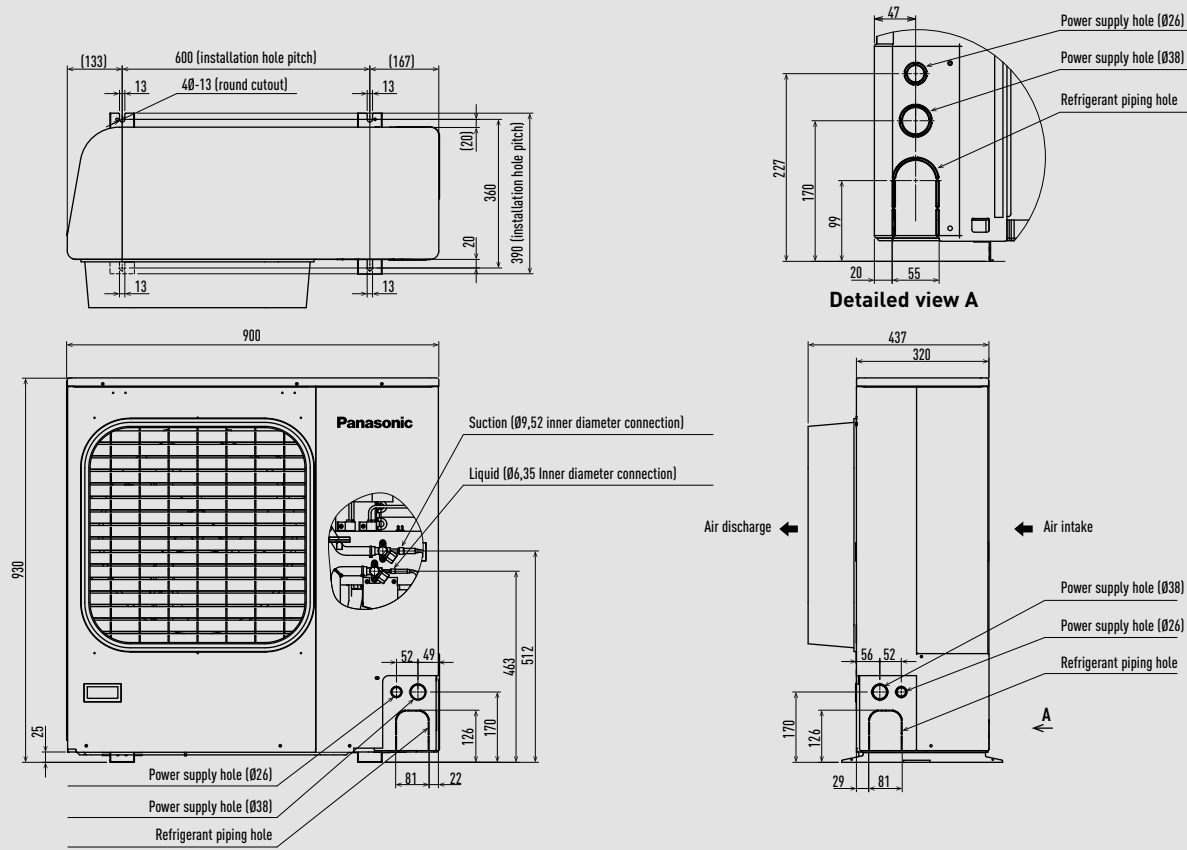

Unit: mm

Condensing units - CR Series OCU-CR400VF8 / OCU-CR400VF8SL / OCU-CR400VF8A / OCU-CR400VF8ASL.

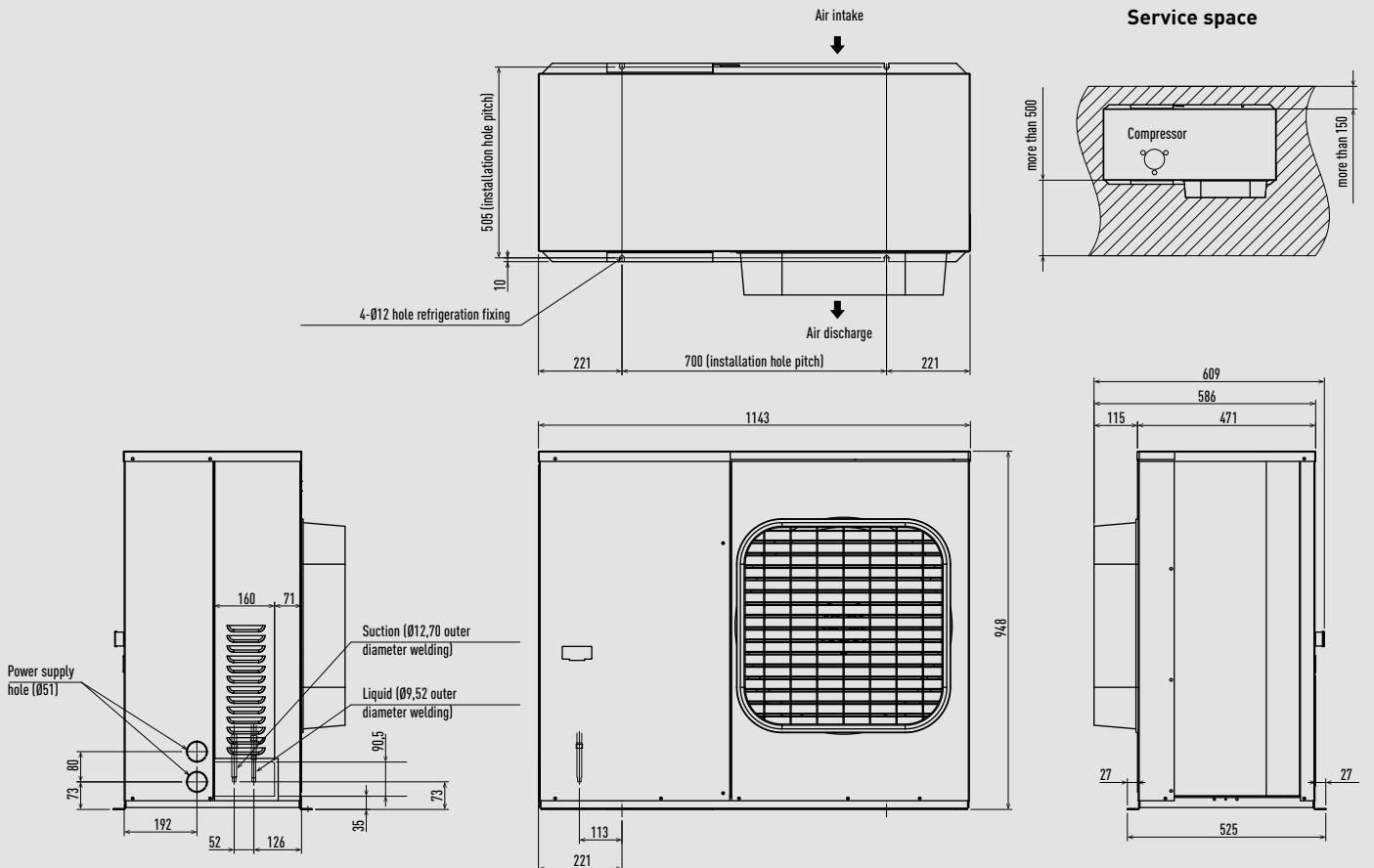

Unit: mm

Condensing units - CR Series OCU-CR1000VF8 / OCU-CR1000VF8SL / OCU-CR1000VF8A / OCU-CR1000VF8ASL.

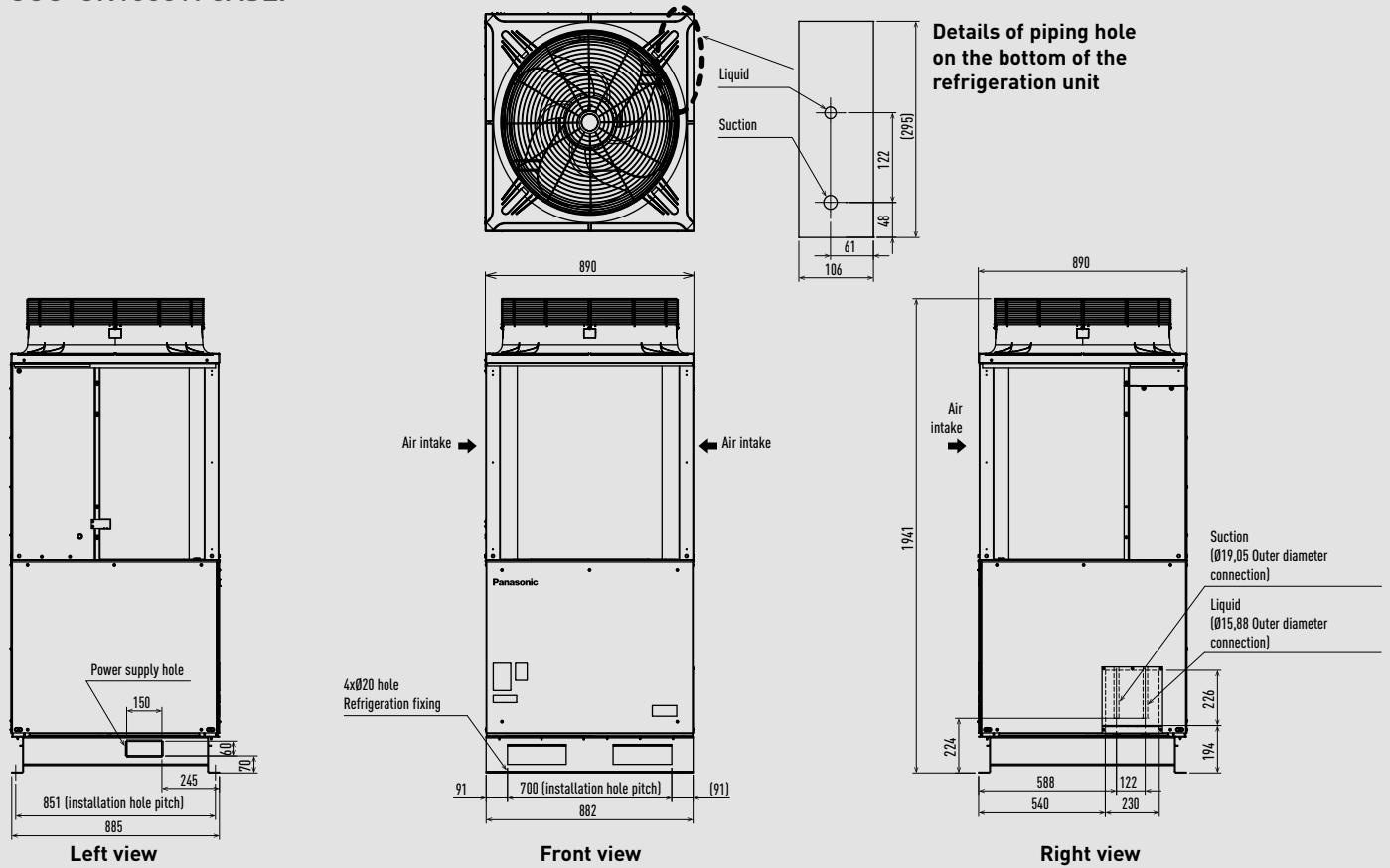

Unit: mm

Wiring diagrams

Domestic

Wall-mounted kits 1x1	→ 579
Floor console kits 1x1	→ 580
Low static pressure hide-away kits 1x1	→ 580
Free Multi System 2 rooms	→ 581
Free Multi System 3 rooms	→ 581
Free Multi System 4 rooms	→ 582
Free Multi System 5 rooms	→ 582

Commercial

Wall-mounted Professional kits 1x1	→ 583
PACi NX wall-mounted kits 1x1	→ 583
PACi NX 4 way 60x60 cassette kits 1x1	→ 584
PACi NX 4 way 90x90 cassette kits 1x1	→ 584
PACi NX ceiling kits 1x1	→ 585
PACi NX adaptive ducted unit kits 1x1	→ 585
Big PACi high static pressure hide-away kits 1x1	→ 586
PACi NX twin system	→ 586
PACi NX triple system	→ 587
PACi NX double-twin system	→ 587

VRF Systems

Mini ECOi Series	→ 588
ECOi EX and ECO G Series	→ 588
Hybrid GHP/EHP	→ 589

Wall-mounted kits 1x1.

Indoor unit



Outdoor unit

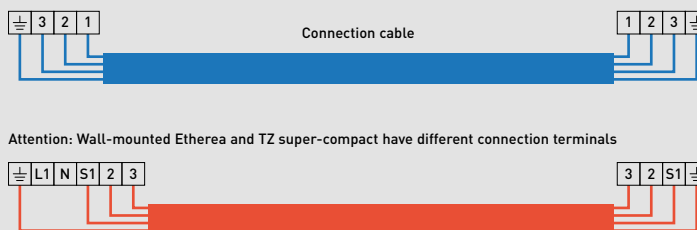

Attention: Wall-mounted Etherea and TZ super-compact have different connection terminals



Single phase
Power supply
230 V / 50 Hz



Infrared remote
controller (included
in the delivery)

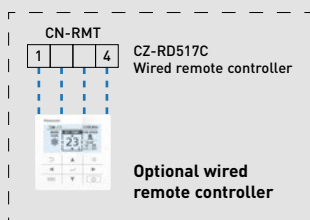

Optional wired
remote controller

Power supply to indoor or outdoor depending on model, see table.

Wall-mounted Heatcharge VZ - R32

Indoor unit	Power supply	Recommended fuse	Connection indoor / outdoor	Outdoor unit
CS-VZ9SKE	230 V (indoor)	16 A	4 x 1,5 mm ²	CU-VZ9SKE
CS-VZ12SKE	230 V (indoor)	16 A	4 x 1,5 mm ²	CU-VZ12SKE

Wall-mounted Etherea Graphite grey, Silver and Matt white - R32

Indoor unit	Power supply	Recommended fuse	Power supply cable	Connection indoor / outdoor	Outdoor unit
CS-XZ20ZKEW-H / CS-XZ20ZKEW / CS-Z20ZKEW	230 V (indoor)	16 A	3 x 1,5 mm ²	4 x 1,5 mm ²	CU-Z20ZKE
CS-XZ25ZKEW-H / CS-XZ25ZKEW / CS-Z25ZKEW	230 V (indoor)	16 A	3 x 1,5 mm ²	4 x 1,5 mm ²	CU-Z25ZKE
CS-XZ35ZKEW-H / CS-XZ35ZKEW / CS-Z35ZKEW	230 V (indoor)	16 A	3 x 1,5 mm ²	4 x 1,5 mm ²	CU-Z35ZKE
CS-XZ42ZKEW-H / - / CS-Z42ZKEW	230 V (indoor)	16 A	3 x 1,5 mm ²	4 x 1,5 mm ²	CU-Z42ZKE
- / CS-XZ50ZKEW / CS-Z50ZKEW	230 V (indoor)	16 A	3 x 2,5 mm ²	4 x 2,5 mm ²	CU-Z50ZKE
- / - / CS-Z71ZKEW	230 V (indoor)	20 A	3 x 2,5 mm ²	4 x 2,5 mm ²	CU-Z71ZKE

Wall-mounted TZ super-compact - R32

Indoor unit	Power supply	Recommended fuse	Power supply cable	Connection indoor / outdoor	Outdoor unit
CS-TZ20ZKEW	230 V (indoor)	16 A	3 x 1,5 mm ²	4 x 1,5 mm ²	CU-TZ20WKE
CS-TZ25ZKEW	230 V (indoor)	16 A	3 x 1,5 mm ²	4 x 1,5 mm ²	CU-TZ25WKE
CS-TZ35ZKEW	230 V (indoor)	16 A	3 x 1,5 mm ²	4 x 1,5 mm ²	CU-TZ35WKE
CS-TZ42ZKEW	230 V (indoor)	16 A	3 x 1,5 mm ²	4 x 1,5 mm ²	CU-TZ42WKE
CS-TZ50ZKEW	230 V (indoor)	16 A	3 x 2,5 mm ²	4 x 2,5 mm ²	CU-TZ50WKE
CS-TZ60ZKEW	230 V (indoor)	20 A	3 x 2,5 mm ²	4 x 2,5 mm ²	CU-TZ60WKE
CS-TZ71ZKEW	230 V (indoor)	20 A	3 x 2,5 mm ²	4 x 2,5 mm ²	CU-TZ71WKE

Wall-mounted BZ super-compact - R32

Indoor unit	Power supply	Recommended fuse	Power supply cable	Connection indoor / outdoor	Outdoor unit
CS-BZ25ZKE	230 V (indoor)	16 A	3 x 1,5 mm ²	4 x 1,5 mm ²	CU-BZ25ZKE
CS-BZ35ZKE	230 V (indoor)	16 A	3 x 1,5 mm ²	4 x 1,5 mm ²	CU-BZ35ZKE
CS-BZ50ZKE	230 V (indoor)	16 A	3 x 2,5 mm ²	4 x 2,5 mm ²	CU-BZ50ZKE
CS-BZ60ZKE	230 V (indoor)	20 A	3 x 2,5 mm ²	4 x 2,5 mm ²	CU-BZ60ZKE

Wall-mounted UZ super-compact - R32

Indoor unit	Power supply	Recommended fuse	Power supply cable	Connection indoor / outdoor	Outdoor unit
CS-UZ25WKE	230 V (indoor)	16 A	3 x 1,5 mm ²	4 x 1,5 mm ²	CU-UZ25WKE
CS-UZ35WKE	230 V (indoor)	16 A	3 x 1,5 mm ²	4 x 1,5 mm ²	CU-UZ35WKE
CS-UZ50WKE	230 V (indoor)	16 A	3 x 2,5 mm ²	4 x 2,5 mm ²	CU-UZ50WKE

Floor console kits 1x1.

Indoor unit



Infrared remote controller (included in the delivery)

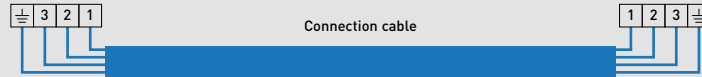

Outdoor unit



Single phase Power supply 230 V / 50 Hz

Floor console - R32

Indoor unit	Power supply	Recommended fuse	Power supply cable	Connection indoor / outdoor	Outdoor unit
CS-Z25UFEAW	230 V (outdoor)	16 A	3 x 1,5 mm ²	4 x 1,5 mm ²	CU-Z25UBEA
CS-Z35UFEAW	230 V (outdoor)	16 A	3 x 1,5 mm ²	4 x 1,5 mm ²	CU-Z35UBEA
CS-Z50UFEAW	230 V (outdoor)	16 A	3 x 2,5 mm ²	4 x 2,5 mm ²	CU-Z50UBEA

Low static pressure hide-away kits 1x1.

Indoor unit



CN-DISP CZ-RD52CP Included wired remote controller



Outdoor unit



Single phase Power supply 230 V / 50 Hz

Low static pressure hide-away kits - R32

Indoor unit	Power supply	Recommended fuse	Power supply cable	Connection indoor / outdoor	Outdoor unit
CS-Z25UD3EAW	230 V (outdoor)	16 A	3 x 1,5 mm ²	4 x 1,5 mm ²	CU-Z25UBEA
CS-Z35UD3EAW	230 V (outdoor)	16 A	3 x 1,5 mm ²	4 x 1,5 mm ²	CU-Z35UBEA
CS-Z50UD3EAW	230 V (outdoor)	16 A	3 x 2,5 mm ²	4 x 1,5 mm ²	CU-Z50UBEA
CS-Z60UD3EAW	230 V (outdoor)	16 A	3 x 2,5 mm ²	4 x 1,5 mm ²	CU-Z60UBEA

Free Multi System 2 rooms.

Indoor unit

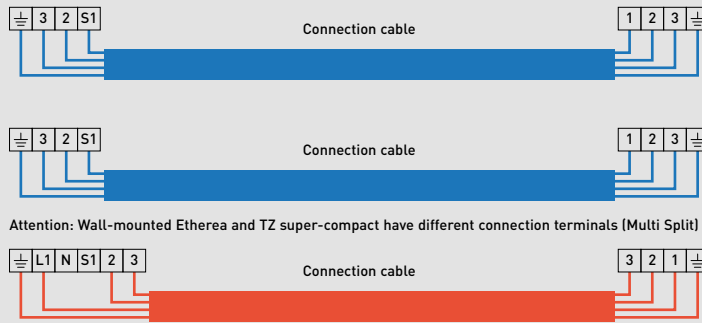
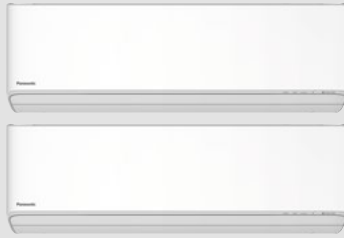

Attention: Wall-mounted Ethearea and TZ super-compact have different connection terminals (Multi Split)

Outdoor unit



Single phase
Power supply
230 V / 50 Hz / 16 A

Free Multi System - R32

Outdoor unit	Power supply	Recommended fuse	Power supply cable	Connection indoor / outdoor
CU-2Z35TBE	230 V	16 A	3 x 1,5 mm ²	4 x 1,5 mm ²
CU-2Z41TBE	230 V	16 A	3 x 1,5 mm ²	4 x 1,5 mm ²
CU-2Z50TBE	230 V	16 A	3 x 1,5 mm ²	4 x 1,5 mm ²
CU-2TZ41TBE	230 V	16 A	3 x 1,5 mm ²	4 x 1,5 mm ²
CU-2TZ50TBE	230 V	16 A	3 x 1,5 mm ²	4 x 1,5 mm ²

Free Multi System 3 rooms.

Indoor unit

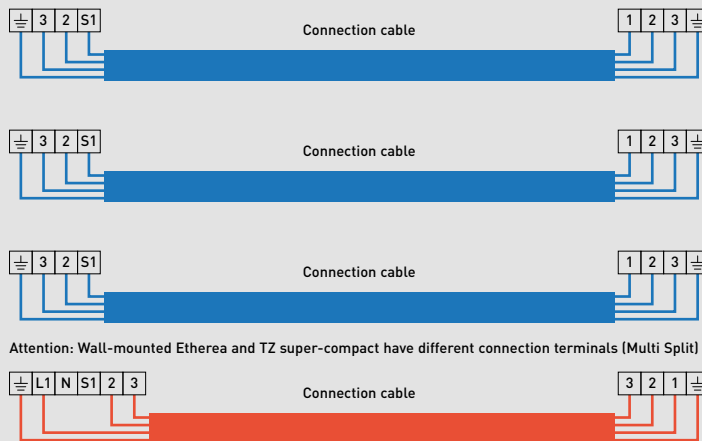

Attention: Wall-mounted Ethearea and TZ super-compact have different connection terminals (Multi Split)

Outdoor unit

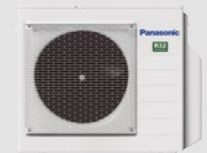

Single phase
Power supply
230 V / 50 Hz / 16 A

Free Multi System - R32

Outdoor unit	Power supply	Recommended fuse	Power supply cable	Connection indoor / outdoor
CU-3Z52TBE	230 V	16 A	3 x 2,5 mm ²	4 x 1,5 mm ²
CU-3Z68TBE	230 V	16 A	3 x 2,5 mm ²	4 x 1,5 mm ²
CU-3TZ52TBE	230 V	16 A	3 x 2,5 mm ²	4 x 1,5 mm ²

Free Multi System 4 rooms.

Indoor unit

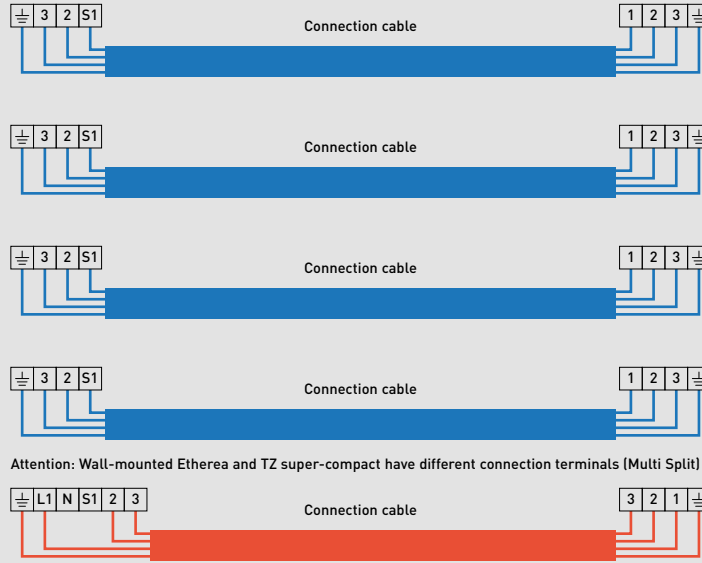

Attention: Wall-mounted Etherea and TZ super-compact have different connection terminals (Multi Split)

Outdoor unit

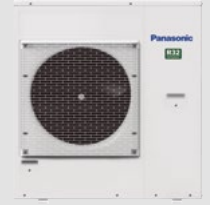

Single phase
Power supply
230 V / 50 Hz / 20 A

Free Multi System · R32

Outdoor unit	Power supply	Recommended fuse	Power supply cable	Connection indoor / outdoor
CU-4Z68TBE	230 V	20 A	3 x 2,5 mm ²	4 x 1,5 mm ²
CU-4Z80TBE	230 V	20 A	3 x 2,5 mm ²	4 x 1,5 mm ²

Free Multi System 5 rooms.

Indoor unit

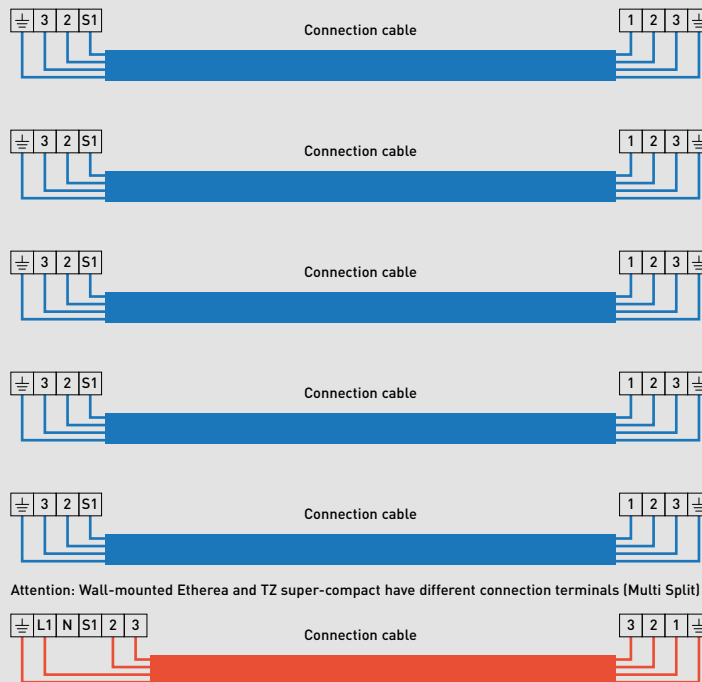

Attention: Wall-mounted Etherea and TZ super-compact have different connection terminals (Multi Split)

Outdoor unit

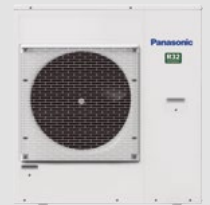

Single phase
Power supply
230 V / 50 Hz / 25 A

Free Multi System · R32

Outdoor unit	Power supply	Recommended fuse	Power supply cable	Connection indoor / outdoor
CU-5Z90TBE	230 V	25 A	3 x 4,0 mm ²	4 x 1,5 mm ²

Wall-mounted Professional kits 1x1.

Indoor unit

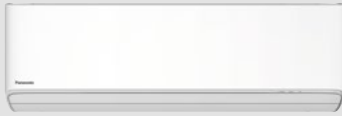

Outdoor unit

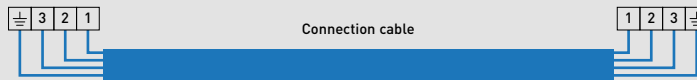

Single phase
Power supply
230 V / 50 Hz

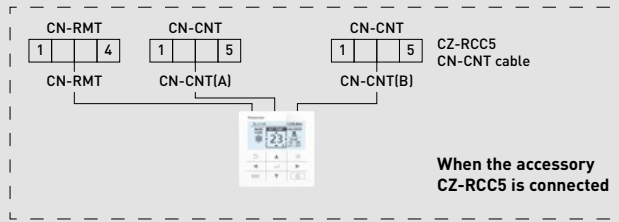
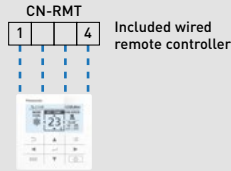

Wall-mounted Professional -25 °C · R32

Indoor unit	Power supply	Recommended fuse	Connection indoor / outdoor	Outdoor unit
CS-Z25YKEA	230 V (indoor)	16 A	4 x 1,5 mm ²	CU-Z25YKEA
CS-Z35YKEA	230 V (indoor)	16 A	4 x 1,5 mm ²	CU-Z35YKEA
CS-Z42YKEA	230 V (indoor)	16 A	4 x 1,5 mm ²	CU-Z42YKEA
CS-Z50YKEA	230 V (indoor)	16 A	4 x 2,5 mm ²	CU-Z50YKEA
CS-Z71YKEA	230 V (indoor)	20 A	4 x 2,5 mm ²	CU-Z71YKEA

PACi NX wall-mounted kits 1x1.

Indoor unit

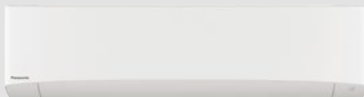

Outdoor unit

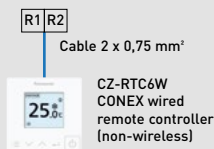

Single phase
Power supply
230 V / 50 Hz / *

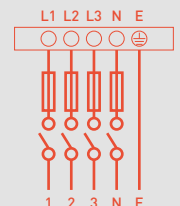

Three phase
Power supply
3 x 400 V / 1 N - 50 Hz / **

Single phase

Indoor unit	Connection indoor / outdoor	Outdoor unit	Power supply	Circuit breaker*
S-3650PK3E	4 x 1,5 mm ²	U-36PZH3E5	220/230/240V	20 A
S-3650PK3E	4 x 1,5 mm ²	U-50PZH3E5		20 A
S-6010PK3E	4 x 1,5 mm ²	U-60PZH3E5		25 A
S-6010PK3E	4 x 2,5 mm ²	U-71PZH4E5		25 A
S-6010PK3E	4 x 2,5 mm ²	U-100PZH4E5		35 A
S-6010PK3E	4 x 1,5 mm ²	U-36PZ3E5		16 A
S-6010PK3E	4 x 1,5 mm ²	U-50PZ3E5		16 A
S-6010PK3E	4 x 1,5 mm ²	U-60PZ3E5A		20 A
S-6010PK3E	4 x 1,5 mm ²	U-71PZ3E5A		20 A
S-6010PK3E	4 x 2,5 mm ²	U-100PZ3E5		35 A

Three phase

Indoor unit	Connection indoor / outdoor	Outdoor unit	Power supply	Circuit breaker**
S-6010PK3E	4 x 2,5 mm ²	U-71PZH4E8	380/400/415V	16 A
S-6010PK3E	4 x 2,5 mm ²	U-100PZH4E8		16 A
S-6010PK3E	4 x 2,5 mm ²	U-100PZ3E8		16 A

PACi NX 4 way 60x60 cassette kits 1x1.

Indoor unit



Outdoor unit

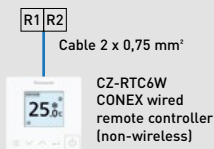

Single phase Power supply
230 V / 50 Hz / 16 A

Single phase

Indoor unit	Connection indoor / outdoor	Outdoor unit	Power supply	Circuit breaker
S-36PY3E	4 x 1,5 mm ²	U-36PZH3E5	220/230/240 V	16 A
S-50PY3E	4 x 1,5 mm ²	U-50PZH3E5		16 A
S-60PY3E	4 x 1,5 mm ²	U-60PZH3E5		16 A
S-25PY3E	4 x 1,5 mm ²	U-25PZ3E5		16 A
S-36PY3E	4 x 1,5 mm ²	U-36PZ3E5		16 A
S-50PY3E	4 x 1,5 mm ²	U-50PZ3E5		16 A
S-60PY3E	4 x 1,5 mm ²	U-60PZ3E5A		16 A

PACi NX 4 way 90x90 cassette kits 1x1.

Indoor unit



Outdoor unit

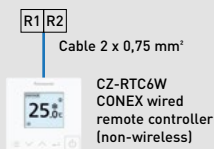

Single phase Power supply
230 V / 50 Hz / *

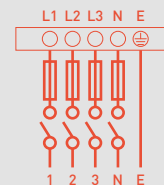

Three phase Power supply
3 x 400 V / 1 N - 50 Hz / **

Single phase

Indoor unit	Connection indoor / outdoor	Outdoor unit	Power supply	Circuit breaker*
S-3650PU3E	4 x 1,5 mm ²	U-36PZH3E5	220/230/240 V	20 A
S-3650PU3E	4 x 1,5 mm ²	U-50PZH3E5		20 A
S-6071PU3E	4 x 1,5 mm ²	U-60PZH3E5		25 A
S-6071PU3E	4 x 2,5 mm ²	U-71PZH4E5		25 A
S-1014PU3E	4 x 2,5 mm ²	U-100PZH4E5		35 A
S-1014PU3E	4 x 2,5 mm ²	U-125PZH4E5		40 A
S-1014PU3E	4 x 2,5 mm ²	U-140PZH4E5		40 A
S-3650PU3E	4 x 1,5 mm ²	U-36PZ3E5		16 A
S-3650PU3E	4 x 1,5 mm ²	U-50PZ3E5		16 A
S-6071PU3E	4 x 1,5 mm ²	U-60PZ3E5A		20 A
S-6071PU3E	4 x 1,5 mm ²	U-71PZ3E5A		20 A
S-6010PU3E	4 x 2,5 mm ²	U-100PZ3E5		35 A
S-1014PU3E	4 x 2,5 mm ²	U-125PZ3E5		40 A
S-1014PU3E	4 x 2,5 mm ²	U-140PZ3E5		40 A

Three phase

Indoor unit	Connection indoor / outdoor	Outdoor unit	Power supply	Circuit breaker**
S-6071PU3E	4 x 2,5 mm ²	U-71PZH4E8	380/400/415 V	16 A
S-1014PU3E	4 x 2,5 mm ²	U-100PZH4E8		16 A
S-1014PU3E	4 x 2,5 mm ²	U-125PZH4E8		16 A
S-1014PU3E	4 x 2,5 mm ²	U-140PZH4E8		16 A
S-1014PU3E	4 x 2,5 mm ²	U-100PZ3E8		20 A
S-1014PU3E	4 x 2,5 mm ²	U-125PZ3E8		20 A
S-1014PU3E	4 x 2,5 mm ²	U-140PZ3E8		20 A

PACi NX ceiling kits 1x1.

Indoor unit

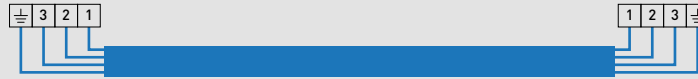
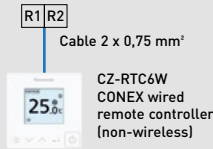

Outdoor unit



Single phase
Power supply
230 V / 50 Hz / *

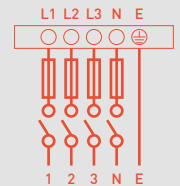

Three phase
Power supply
3 x 400 V / 1 N - 50 Hz / **

Single phase

Indoor unit	Connection indoor / outdoor	Outdoor unit	Power supply	Circuit breaker*
S-3650PT3E	4 x 1,5 mm ²	U-36PZH3E5	220 / 230 / 240 V	20 A
S-3650PT3E	4 x 1,5 mm ²	U-50PZH3E5		20 A
S-6071PT3E	4 x 1,5 mm ²	U-60PZH3E5		25 A
S-6071PT3E	4 x 2,5 mm ²	U-71PZH4E5		25 A
S-1014PT3E	4 x 2,5 mm ²	U-100PZH4E5		35 A
S-1014PT3E	4 x 2,5 mm ²	U-125PZH4E5		40 A
S-1014PT3E	4 x 2,5 mm ²	U-140PZH4E5		40 A
S-3650PT3E	4 x 1,5 mm ²	U-36PZ3E5		16 A
S-3650PT3E	4 x 1,5 mm ²	U-50PZ3E5		16 A
S-6071PT3E	4 x 1,5 mm ²	U-60PZ3E5A		20 A
S-6071PT3E	4 x 1,5 mm ²	U-71PZ3E5A		20 A
S-6010PT3E	4 x 2,5 mm ²	U-100PZ3E5		35 A
S-1014PT3E	4 x 2,5 mm ²	U-125PZ3E5		40 A
S-1014PT3E	4 x 2,5 mm ²	U-140PZ3E5		40 A

Three phase

Indoor unit	Connection indoor / outdoor	Outdoor unit	Power supply	Circuit breaker**
S-6071PT3E	4 x 2,5 mm ²	U-71PZH4E8	380 / 400 / 415 V	16 A
S-1014PT3E	4 x 2,5 mm ²	U-100PZH4E8		16 A
S-1014PT3E	4 x 2,5 mm ²	U-125PZH4E8		16 A
S-1014PT3E	4 x 2,5 mm ²	U-140PZH4E8		16 A
S-1014PT3E	4 x 2,5 mm ²	U-100PZ3E8		20 A
S-1014PT3E	4 x 2,5 mm ²	U-125PZ3E8		20 A
S-1014PT3E	4 x 2,5 mm ²	U-140PZ3E8		20 A

PACi NX adaptive ducted unit kits 1x1.

Indoor unit

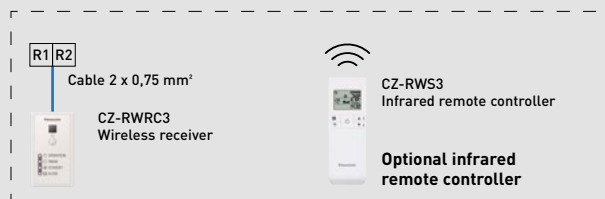
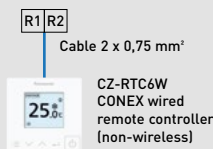

Outdoor unit



Single phase
Power supply
230 V / 50 Hz / *

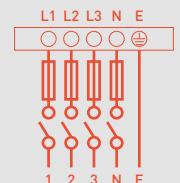

Three phase
Power supply
3 x 400 V / 1 N - 50 Hz / **

Single phase

Indoor unit	Connection indoor / outdoor	Outdoor unit	Power supply	Circuit breaker*
S-3650PF3E	4 x 1,5 mm ²	U-36PZH3E5	220 / 230 / 240 V	20 A
S-3650PF3E	4 x 1,5 mm ²	U-50PZH3E5		20 A
S-6071PF3E	4 x 1,5 mm ²	U-60PZH3E5		25 A
S-6071PF3E	4 x 2,5 mm ²	U-71PZH4E5		25 A
S-1014PF3E	4 x 2,5 mm ²	U-100PZH4E5		35 A
S-1014PF3E	4 x 2,5 mm ²	U-125PZH4E5		40 A
S-1014PF3E	4 x 2,5 mm ²	U-140PZH4E5		40 A
S-3650PF3E	4 x 1,5 mm ²	U-36PZ3E5		16 A
S-3650PF3E	4 x 1,5 mm ²	U-50PZ3E5		16 A
S-6071PF3E	4 x 1,5 mm ²	U-60PZ3E5A		20 A
S-6071PF3E	4 x 1,5 mm ²	U-71PZ3E5A		20 A
S-6010PF3E	4 x 2,5 mm ²	U-100PZ3E5		35 A
S-1014PF3E	4 x 2,5 mm ²	U-125PZ3E5		40 A
S-1014PF3E	4 x 2,5 mm ²	U-140PZ3E5		40 A

Three phase

Indoor unit	Connection indoor / outdoor	Outdoor unit	Power supply	Circuit breaker**
S-6071PF3E	4 x 2,5 mm ²	U-71PZH4E8	380 / 400 / 415 V	16 A
S-1014PF3E	4 x 2,5 mm ²	U-100PZH4E8		16 A
S-1014PF3E	4 x 2,5 mm ²	U-125PZH4E8		16 A
S-1014PF3E	4 x 2,5 mm ²	U-140PZH4E8		16 A
S-1014PF3E	4 x 2,5 mm ²	U-100PZ3E8		20 A
S-1014PF3E	4 x 2,5 mm ²	U-125PZ3E8		20 A
S-1014PF3E	4 x 2,5 mm ²	U-140PZ3E8		20 A

Big PACi high static pressure hide-away 20,0-25,0 kW kits 1x1.

Indoor unit

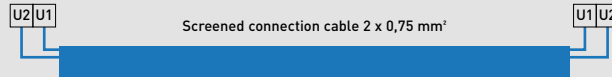

Outdoor unit

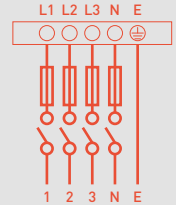
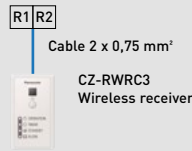
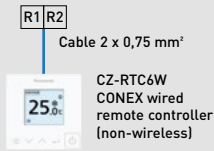

Single phase
Power supply
230 V / 50 Hz / 10 A

Three phase
Power supply
3 x 400 V / 1 N - 50 Hz

Three phase

Indoor unit	Power supply	Outdoor unit	Power supply	Circuit breaker
S-200PE3E5B	220 / 230 / 240 V	U-200PZH2E8	380 / 400 / 415 V	16 A
S-250PE3E5B		U-250PZH2E8		20 A

PACi NX twin system.

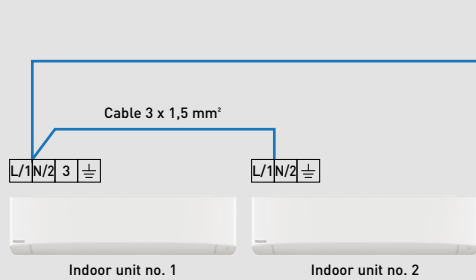

Outdoor unit

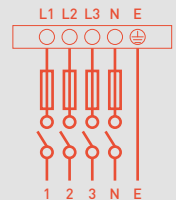
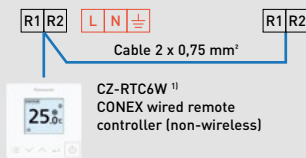

Single phase
Power supply
230 V / 50 Hz / *

Three phase
Power supply
3 x 400 V / 1 N - 50 Hz / **

Single phase

Outdoor unit	Power supply	Circuit breaker*
U-71PZH4E5	220 / 230 / 240 V	25 A
U-100PZH4E5		35 A
U-125PZH4E5		40 A
U-140PZH4E5		40 A
U-100PZ3E5		35 A
U-125PZ3E5		40 A
U-140PZ3E5		40 A

Three phase

Outdoor unit	Power supply	Circuit breaker**
U-71PZH4E8	380 / 400 / 415 V	16 A
U-100PZH4E8		16 A
U-125PZH4E8		16 A
U-140PZH4E8		16 A
U-200PZH2E8		20 A
U-250PZH2E8		30 A
U-100PZ3E8		16 A
U-125PZ3E8		20 A
U-140PZ3E8	20 A	

1) Optional infrared remote controller is also possible. Wireless receivers may be required depending on indoor units.

PACi NX triple system.

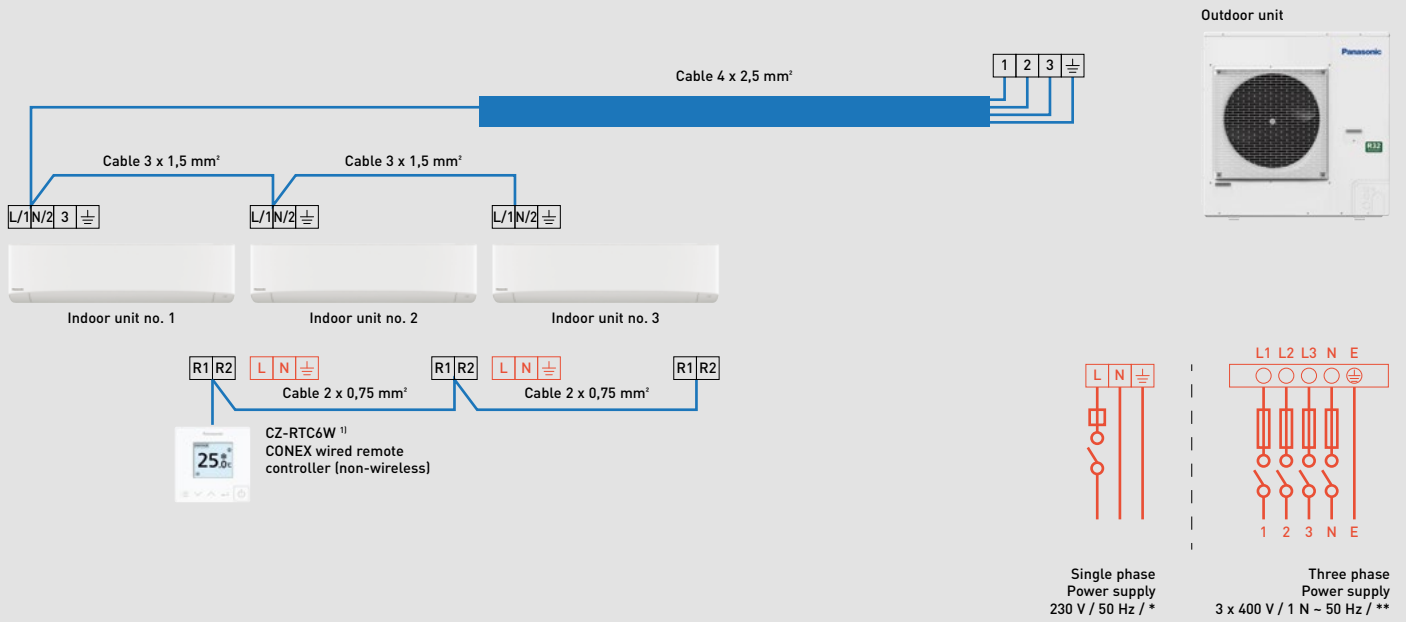

Single phase

Outdoor unit	Power supply	Circuit breaker*
U-71PZH4E5	220 / 230 / 240 V	25 A
U-100PZH4E5		35 A
U-125PZH4E5		35 A
U-140PZH4E5		40 A

Three phase

Outdoor unit	Power supply	Circuit breaker**
U-71PZH4E8	380 / 400 / 415 V	16 A
U-100PZH4E8		16 A
U-125PZH4E8		16 A
U-140PZH4E8		16 A

1) Optional infrared remote controller is also possible. Wireless receivers may be required depending on indoor units.

PACi NX double-twin system.

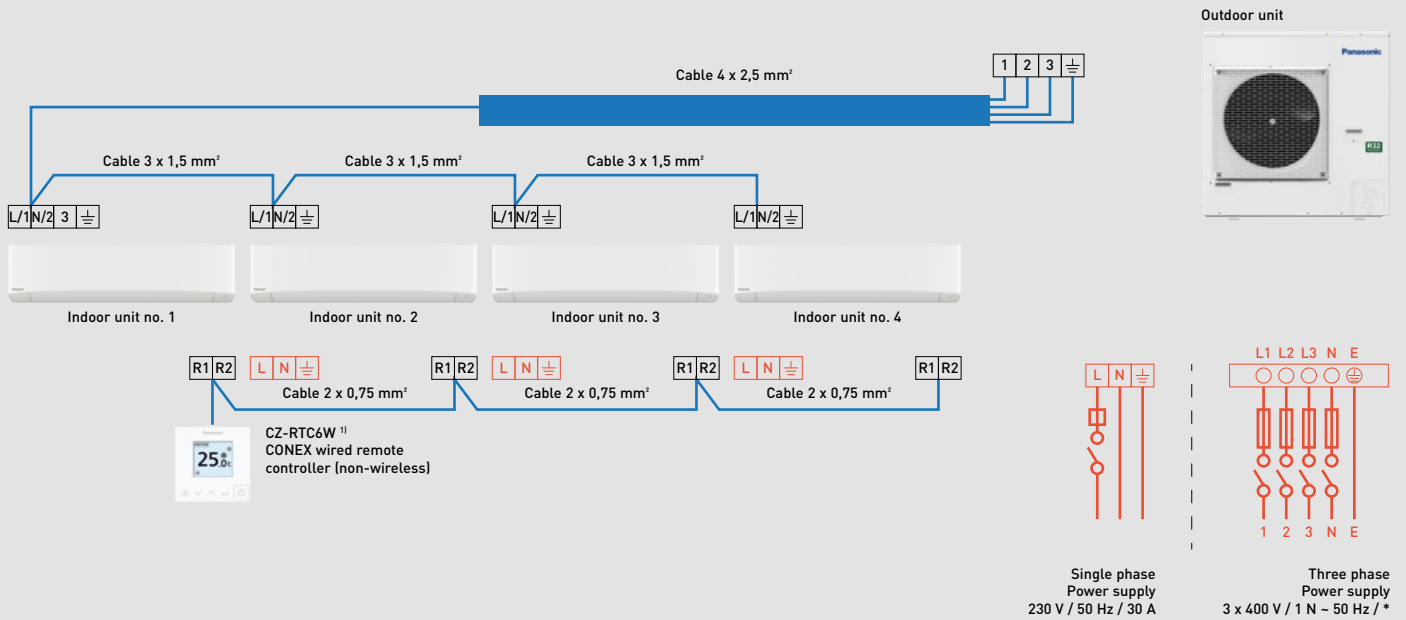

Single phase

Outdoor unit	Power supply	Circuit breaker
U-100PZ3E5	220 / 230 / 240 V	35 A
U-125PZH4E5		40 A

Three phase

Outdoor unit	Power supply	Circuit breaker*
U-100PZH4E8	380 / 400 / 415 V	16 A
U-125PZH4E8		16 A

1) Optional infrared remote controller is also possible. Wireless receivers may be required depending on indoor units.

Mini ECOi Series.

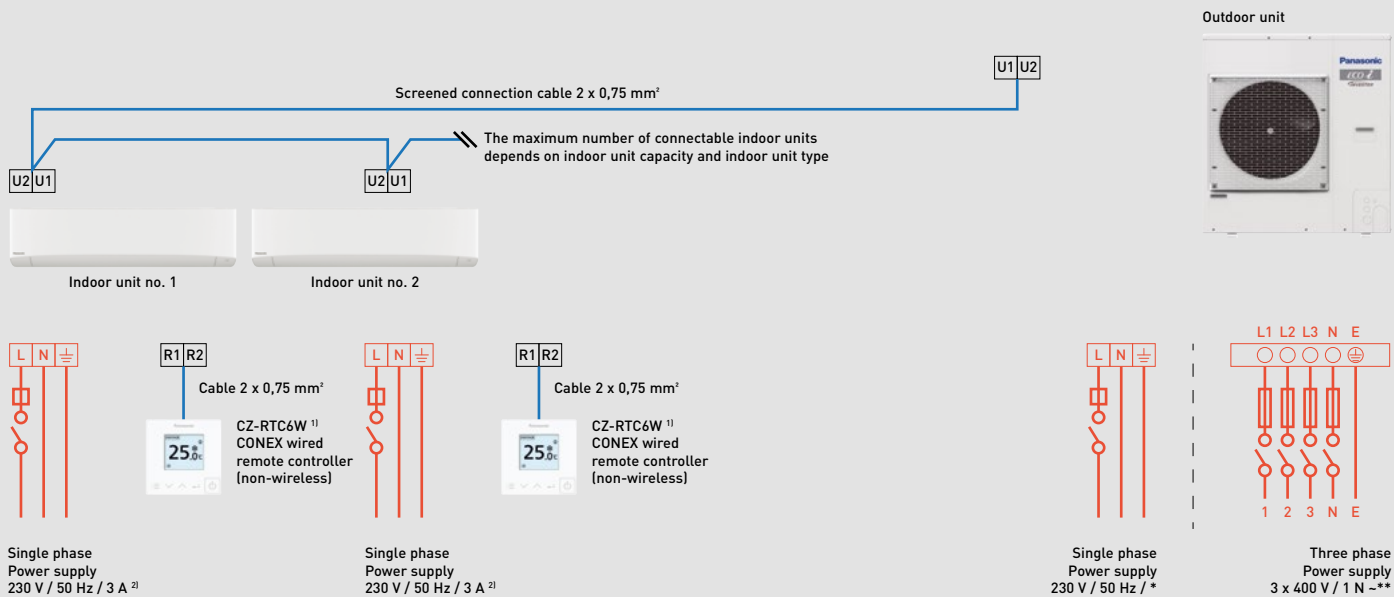

Single phase

Outdoor unit	Power supply	Circuit breaker*
U-4LZ2E5	220 / 230 / 240 V	20 A
U-5LZ2E5		25 A
U-6LZ2E5		30 A
U-4LE2E5		20 A
U-5LE2E5		25 A
U-6LE2E5		30 A

1) Optional infrared remote controller is also possible. Wireless receivers may be required depending on indoor units.
 2) 10 A for single indoor connection to S-224ME2E5 / S-280ME2E5, in combination with U-8LE1E8 / U-10LE1E8.

Three phase

Outdoor unit	Power supply	Circuit breaker**
U-4LZ2E8	380 / 400 / 415 V	10 A
U-5LZ2E8		16 A
U-6LZ2E8		16 A
U-8LZ2E8		16 A
U-10LZ2E8		20 A
U-4LE2E8		10 A
U-5LE2E8		16 A
U-6LE2E8		16 A
U-8LE1E8		16 A
U-10LE1E8		20 A

ECOi EX and ECO G Series.

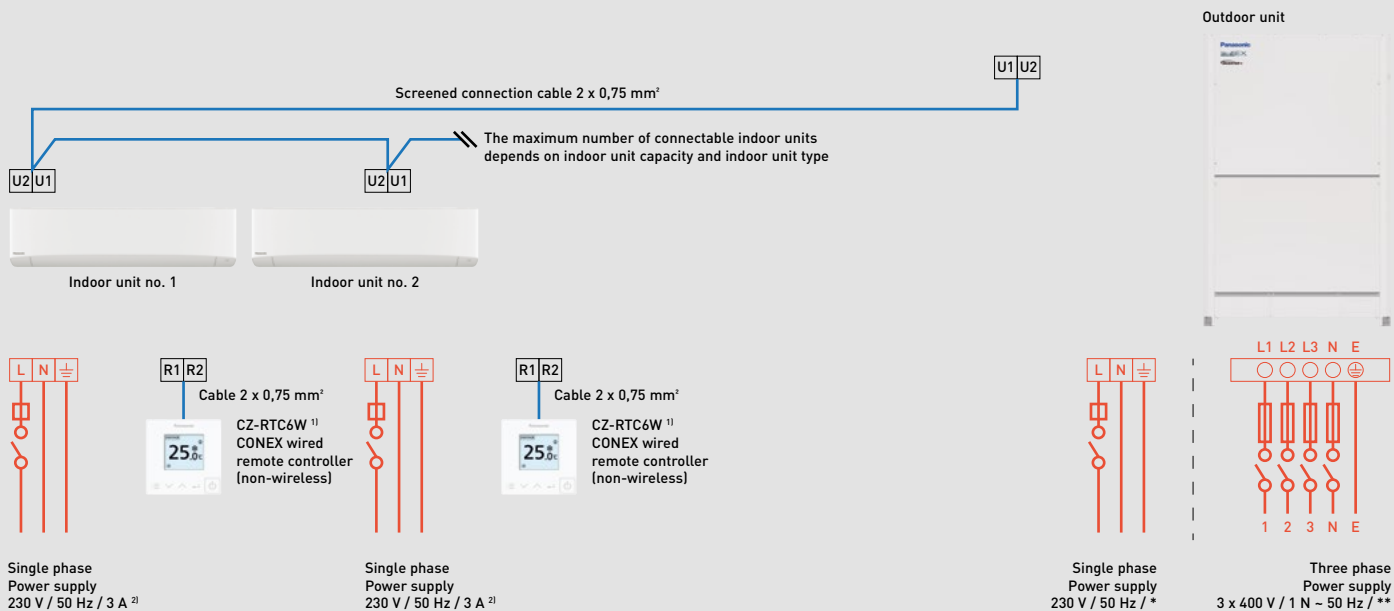

ECOi EX Series

2-Pipe			3-Pipe		
Outdoor unit	Power supply	Circuit breaker**	Outdoor unit	Power supply	Circuit breaker**
U-8ME2E8	380 / 400 / 415 V	16 A	U-8MF3E8	380 / 400 / 415 V	16 A
U-10ME2E8		16 A	U-10MF3E8		20 A
U-12ME2E8		20 A	U-12MF3E8		25 A
U-14ME2E8		25 A	U-14MF3E8		40 A
U-16ME2E8		30 A	U-16MF3E8		30 A
U-18ME2E8		40 A			
U-20ME2E8	40 A				

ECO G Series

2-Pipe			3-Pipe		
Outdoor unit	Power supply	Circuit breaker*	Outdoor unit	Power supply	Circuit breaker*
U-16GE3E5	220 / 230 / 240 V	16 A	U-16GF3E5	220 / 230 / 240 V	16 A
U-20GE3E5		16 A	U-20GF3E5		16 A
U-25GE3E5		16 A	U-25GF3E5		16 A
U-30GE3E5		16 A			

1) Optional infrared remote controller is also possible. Wireless receivers may be required depending on indoor units.
 2) 10 A for single indoor connection to S-224ME2E5 / S-280ME2E5.

Hybrid GHP/EHP.

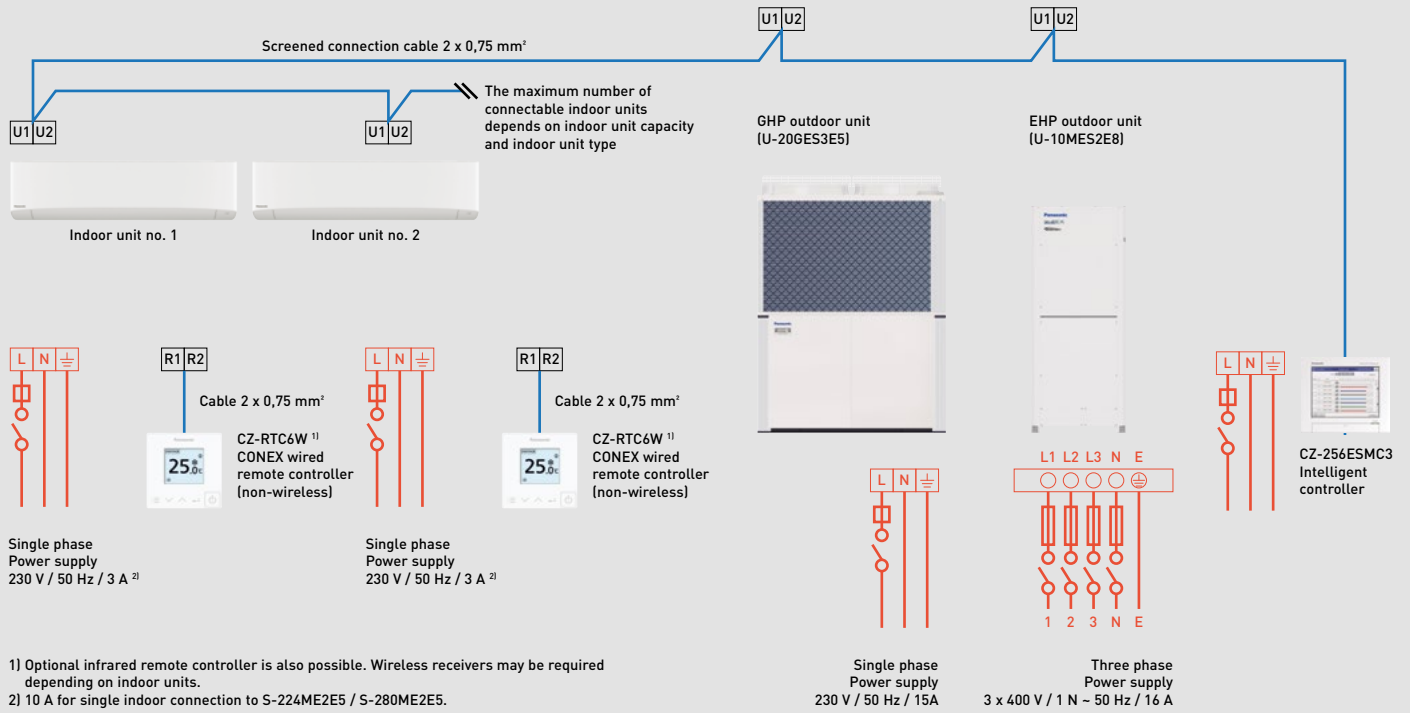

Panasonic service

Our Panasonic Service teams are committed to ensuring your peace of mind. Best service is our aim.

Panasonic provides a team of highly trained technicians and engineers to deliver professional and responsive services that meet the highest levels of quality and safety while being efficient and cost effective.

To find out more about Panasonic Heating & Cooling Solutions, please visit www.aircon.panasonic.eu.



Maintenance.

To meet the requirements of the standard warranty, the product must be maintained and serviced annually by a suitably trained and qualified engineer. This way we can extend the lifetime of the product.



Repair.

Panasonic offers a wide range of service agreements, like Panasonic Service+ for a maximized product lifetime. Leave the care of your Panasonic products to the experts. In the unlikely event that something goes wrong, trust one of our qualified and Panasonic trained experts to get things back on track.



Warranty.

In accordance with the regulations, Panasonic guarantees its products against hidden defects. Moreover, Panasonic grants to the professional purchaser a commercial warranty, specific to the product families, subject to compliance of all the rules of installation and use of its products.

Panasonic Heating & Cooling Solutions customer service

Panasonic enables different channels for end users or professionals to get in touch with us:



Use our European website www.aircon.panasonic.eu for contacting us.

Panasonic has implemented a contact page on the Panasonic Heating & Cooling Solutions website for potential or existing Panasonic customers.

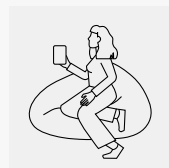

Another option is to contact the highly experienced teams at the Panasonic customer service center, who are more than qualified to support Panasonic clients in 13 different languages across Europe.

Our service center in Europe for end customers:

Country	B2C support center	Opening times
Spain	900 82 87 87	Mo-Fr 9-17h
Portugal	800 78 22 20	Mo-Fr 9-17h
France	0800 805 215	Mo-Fr 9-17h
Italy	+39 2 6433235	Mo-Fr 9-17h
United Kingdom	0808 208 2115	Mo-Fr 9-17h
Ireland	1800 939 977	Mo-Fr 9-17h
Poland	800 080 911	Mo-Fr 9-17h
Denmark	+45 89 87 45 00	Mo-Fr 9-17h
Sweden	+46 85 221 81 00	Mo-Fr 9-17h
Finland	+35 8646041590	Mo-Fr 9-17h

Country	B2C support center	Opening times
Norway	+47 69 67 61 00	Mo-Fr 9-17h
Germany	+49 611 71187211	Mo-Sat 7-18h
Hungary	+36 1 700 89 65	Mo-Fr 9-17h
Switzerland DE	+41 415615366	Mo-Fr 9-17h
Switzerland FR	+41 435880049	Mo-Fr 9-17h
Switzerland IT	+41 435880048	Mo-Fr 9-17h
The Netherlands	+31 73 6402 538	Mo-Sat 7-18h
Belgium NL	+32 2 320 55 38	Mo-Fr 9-17h
Belgium FR	+32 2 320 55 38	Mo-Fr 9-17h
Luxemburg	+32 2 320 55 38	Mo-Fr 9-17h



www.aircon.panasonic.eu

heating & cooling solutions

Due to the ongoing innovation of our products, the specifications of this catalogue are valid barring typographic errors, and may be subject to minor modifications by the manufacturer without prior warning in order to improve the product. The total or partial reproduction of this catalogue is prohibited without the express authorisation of Panasonic Marketing Europe GmbH.

Panasonic Marketing Europe GmbH
Panasonic Heating & Ventilation Air-Conditioning Europe

Hagenauer Strasse 43, 65203 Wiesbaden, Germany
www.aircon.panasonic.eu

Ireland

Panasonic Heating & Cooling Solutions
1 The Courtyard, Kiltcarbery Business Park, Nangor Road, Dublin D22 R791, Ireland
☎ 1800 939 977
www.aircon.panasonic.ie

France / Belgium / Luxemburg

Panasonic Solutions Chauffage & Refroidissement
1 à 7 Rue du 19 Mars 1962, 92238, Gennevilliers Cedex, France
☎ 0800 805 215 (France)
+32 2 320 55 38 (Belgium & Luxemburg)
www.aircon.panasonic.eu

Germany / Austria / Switzerland

Panasonic Heiz- & Kühlsysteme
Hagenauer Str. 43, 65203 Wiesbaden, Germany
☎ +49 611 711 87 211 (Germany)
+43 1 253 22 120 (Austria)
+41 41 561 53 66 (Switzerland)
HLK-Support-DE@eu.panasonic.com (Germany)
HLK-Support-AT@eu.panasonic.com (Austria)
HLK-Support-CH@eu.panasonic.com (Switzerland)
www.aircon.panasonic.eu

Poland

Panasonic Heating & Cooling Solutions
Wotoska 9, 02-583, Warszawa, Polska
☎ 800 080 911
✉ info.pl@panasonicproclub.com
www.aircon.panasonic.pl

The Netherlands

Panasonic Heating & Cooling Solutions
Europalaan 28E, 5332 BC, 's-Hertogenbosch, The Netherlands
☎ +31 736 402 538
www.aircon.panasonic.nl

Spain / Portugal

Panasonic Heating & Cooling Solutions
WTC Almeda Park, plaza de la Pau s/n, Edificio 6, planta 4ª, Local D - 08940 Cornellà de Llobregat, Spain
☎ 900 82 87 87 (Spain)
800 78 22 20 (Portugal)
www.aircon.panasonic.eu

Italy / Malta / Cyprus / Greece

Panasonic Heating & Cooling Solutions
Viale dell'Innovazione, 3, 20126, Milano, Italy
☎ +39 02 6433235 (Customer Service)
www.aircon.panasonic.eu

Sweden / Denmark / Norway / Finland

Panasonic Heating & Cooling Solutions
Sundbybergsvägen 1, 171 73 Solna, Sweden
☎ +46 85 221 81 00 (Sweden)
+45 89 87 45 00 (Denmark)
+47 69 67 61 00 (Norway)
+35 86 46 04 15 90 (Finland)
www.aircon.panasonic.eu

Czech Republic / Slovakia

Panasonic Heating & Cooling Solutions
Křižíkova 148/34, 186 00 Praha 8, Czech Republic
☎ +420 236 032 911
✉ panasonic.praha@eu.panasonic.com
www.aircon.panasonic.cz

Hungary / Albania / Bosnia / Bulgaria / Croatia / Kosovo / Montenegro / Romania / Serbia / Slovenia

Panasonic Heating & Cooling Solutions
Alíz utca 3. - Office Garden III, 1117 Budapest, Hungary
☎ +36 1 700 89 65
✉ panasonicaquarea@eu.panasonic.com
www.aircon.panasonic.eu

United Kingdom

Panasonic Heating & Ventilation Air-Conditioning UK Ltd.

Building 3, Albany Place, Hydeway, Welwyn Garden City, AL7 3BT, United Kingdom
☎ +44 1707 378 670
✉ sales.PHVACUK@eu.panasonic.com
www.aircon.panasonic.co.uk



Do not add or replace refrigerant other than the specified type. Manufacturer is not responsible for the damage and deterioration in safety due to usage of the other refrigerant. The outdoor units in this catalogue contains fluorinated greenhouse gases with a GWP higher than 150.



To find out how Panasonic cares for you,
log on to: **www.aircon.panasonic.eu**

Panasonic Marketing Europe GmbH
Panasonic Heating & Ventilation Air-conditioning Europe
Hagenauer Strasse 43, 65203 Wiesbaden, Germany