

# Panasonic

NEW  
AQUAREA RANGE  
HIGH-EFFICIENCY  
HEAT PUMP  
TECHNOLOGY

2013 / 2014



NEW AQUAREA AIR TO WATER HEAT PUMP 2013 / 2014

heatingandcoolingsystems

# NEW 2013 / 2014

## AQUAREA RANGE

### Summary

PANASONIC – LEADING THE WAY IN HEATING & COOLING .....	4	AQUAREA T-CAP BI-BLOC SINGLE PHASE / THREE PHASE, HEATING ONLY - SXF, HEATING AND COOLING - SXC .....	30
PANASONIC PROFESSIONAL .....	6	AQUAREA HT BI-BLOC SINGLE PHASE / THREE PHASE HEATING ONLY - SHF .....	31
NEW AQUAREA AIR TO WATER HEAT PUMP .....	8	AQUAREA HIGH PERFORMANCE MONO-BLOC SINGLE PHASE, HEATING ONLY - MDF, HEATING AND COOLING - MDC, 6 AND 9 KW .....	32
NEW PANASONIC R2 ROTARY COMPRESSOR .....	10	AQUAREA HIGH PERFORMANCE MONO-BLOC SINGLE PHASE / THREE PHASE, HEATING ONLY - MDF, HEATING AND COOLING - MDC .....	33
HOW DO YOU GET HEATING AND HOT WATER FROM AIR? .....	12	AQUAREA T-CAP MONO-BLOC SINGLE PHASE / THREE PHASE, HEATING ONLY - MXF, HEATING AND COOLING - MXC .....	34
"GREEN" HIGH-EFFICIENCY HEATING WITH PANASONIC'S NEW AIR TO WATER HEAT PUMP SYSTEMS .....	14	AQUAREA HT MONO-BLOC SINGLE PHASE / THREE PHASE HEATING ONLY - MHF .....	35
THE AQUAREA HEATING AND HOT WATER SYSTEM AND HEAT PUMP + PHOTOVOLTAIC .....	16	ACCESSORIES .....	36
WHAT MAKES THE AIR TO WATER HEAT PUMP WORK .....	18	EXAMPLES OF INSTALLATIONS WITH AQUAREA MANAGER .....	37
NEW AQUAREA 3 AND 5 KW BI-BLOC AND 6 AND 9 KW MONO-BLOC AIR TO WATER HEAT PUMP .....	20	NEW AQUAREA AIR .....	38
CONTROL & CONNECTIVITY. THE NEXT GENERATION OF AQUAREA MANAGER .....	22	HEATING CAPACITY TABLE BASED ON OUTLET TEMPERATURE AND OUTSIDE TEMPERATURE .....	40
CONTROL YOUR HEAT PUMP FROM WHEREVER YOU ARE AT HOME. CONTROL YOUR COMFORT AND EFFICIENCY WITH THE LOWEST ENERGY CONSUMPTION .....	24	DIMENSIONS .....	48
AQUAREA LINE-UP! .....	26	ERROR CODES .....	50
AQUAREA HIGH PERFORMANCE BI-BLOC SINGLE PHASE, HEATING ONLY - SDF, HEATING AND COOLING - SDC, 3 AND 5 KW .....	28		
AQUAREA HIGH PERFORMANCE BI-BLOC SINGLE PHASE / THREE PHASE, HEATING ONLY - SDF, HEATING AND COOLING - SDC .....	29		



ISO 9000 Series Certification  
**CERTIFIED TO MS ISO 9002:1994**  
 Panasonic HA Air-Conditioning (M) Sdn. Bhd. (PHAAM)  
 (Formerly known as Matsushita Industrial Corp. Sdn. Bhd.)  
 Registration No.: AR 0866



Environment Management Systems Approval Certificate  
**CERTIFIED TO MS ISO 14001:1997**  
 Panasonic HA Air-Conditioning (M) Sdn. Bhd. (PHAAM)  
 (Formerly known as Matsushita Industrial Corp. Sdn. Bhd.)  
 Certification No.: M015802127

# NEW

T-CAP WITH A CLASS PUMP FOR HIGH SAVINGS



PG 30

# NEW

NEW 3.5 AND 6 kW HEAT PUMPS FOR YOUR COMFORT AND LOW CONSUMPTION



PG 14

# NEW

AQUAREA MANAGER. SMART CONTROLLERS FOR ECO-EFFICIENT HEATING



**155**  
PRECONFIGURED  
INSTALLATIONS

PG 22

# NEW

CONNECTIVITY SOLUTIONS FOR A BETTER CONTROL



PG 24

# NEW

SUPER LOW TEMPERATURE RADIATORS, FOR HIGH EFFICIENT INSTALLATION



**35°C**  
WATER  
TEMPERATURE

PG 38

# NEW

LINE UP OF SUPER EFFICIENT TANKS

\* For Super High Efficiency 200 litres tank.



**2.3m<sup>2</sup>\***  
EXCHANGE  
SURFACE

PG 36



## Panasonic – leading the way in Heating & Cooling

With more than 30 years of experience, selling to more than 120 countries around the world, Panasonic is unquestionably one of the leaders in the heating and cooling sector.

With a diverse network of production and R&D facilities, Panasonic delivers innovative products incorporating cutting-edge technologies that set the standard for air conditioners worldwide. Expanding globally, Panasonic provides superior international products transcending borders.

### History of Air Conditioning Group

Panasonic starts with a desire to create things of value. As hard work and dedication results in one innovative product after another, the fledgling company takes its first steps towards becoming the electronics giant of today.

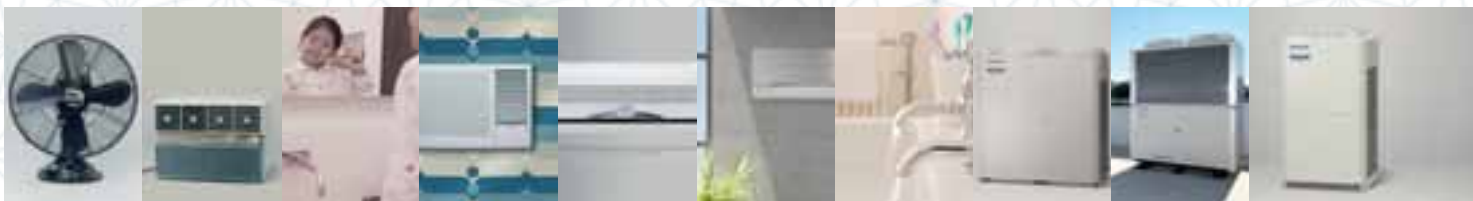

- |   |  |   |   |  |  |   |   |  |  |
|---|--|---|---|--|--|---|---|--|--|
| <p><b>1936</b><br/>First electric Fan with Automatic Oscillation (36 cm table top model).</p> | <p><b>1958</b><br/>First room air conditioner launched for domestic installation. Prior to this date, air conditioners were large and only for commercial use. Panasonic developed the first compact air conditioner for windows; it was lightweight and easy to install, improving the quality of life in Japanese homes. 1,100 units were sold in Japan in the first year, and just two years later, in 1960, this figure rose to 230,000.</p> | <p><b>1973</b><br/>Panasonic launches the first highly efficient air-to-water heat pump in Japan.</p> | <p><b>1975</b><br/>Panasonic becomes the first Japanese air conditioner manufacturer in Europe.</p> | <p><b>2002</b><br/>The Ion and Oxygen Generator — two of the most important contributions to air conditioning systems.</p> | <p><b>2008</b><br/>Etherea new concept of air conditioning systems: high efficiency and high performances with a great design. Etherea also includes a very innovative air quality sensor and air purifier in order to enjoy healthy air at home at all times.</p> | <p><b>2010</b><br/>New Aquarea. Panasonic has created Aquarea, an innovative new, low-energy system, designed to help you enjoy ideal temperatures and hot water in your home, even with extreme outdoor temperatures. Aquarea cools or heats to ensure maximum comfort. Aquarea is far cleaner, safer, cheaper and environmentally friendly than alternatives using gas, oil and other electrical systems.</p> | <p><b>2011</b><br/>New Eco i VRF solution. The new Panasonic VRF solution for big buildings is the most efficient in the industry in more than 74% of combinations. ECO i satisfies the most demanding standards required by design offices, architects, owners and installers.</p> | <p><b>2012</b><br/>New GHP units. Panasonic's gas-driven VRF systems are ideal for projects where power restrictions apply. In 2012, Panasonic extends the Gas Heat Pump range with a new GHP line-up, new GHP G Power (electricity production) and the new Chiller Units.</p> | <p><b>2013</b><br/>New ECOi 3-pipes. The best efficiency for your building. Our New 6 Series 3-pipes is achieving a COP of 4.77 at full load, and even more when recovering heat from the building. There is no doubt, Panasonic is reducing environmental impact!</p> |
|---|--|---|---|--|--|---|---|--|--|



**Panasonic Europe**

Panasonic is committed to offering our customers innovative products in the heating and cooling market across Europe, which not only meet but exceed their requirements. Key to success is Panasonic's investment in R&D, manufacture and training to ensure innovative, cutting edge products and investment in our distribution channels and partners so that these products are accessible in Europe. Panasonic has developed a comprehensive network across Europe of training centers and training academies for installers, design offices and service teams in all major countries.



**Panasonic Factories and R&D Department**

There is a close relationship between R&D innovation and good manufacturing processes, and so Panasonic has placed its R&D facilities very close to its manufacturing bases. This ensures good integration between all divisions to deliver high quality and reliable solutions to our markets.

**We control the process**

The company is also a world leader in innovation as it has filed more than 91,539 patents to improve its customers' lives. Moreover, Panasonic is determined to remain at the forefront of its market. In all, the company has produced more than 200 million compressors and its products are manufactured in 294 plants which are located all over the world. You can be assured of the extremely high quality of Panasonic's heat pumps. This wish to excel has made Panasonic the international leader in heating and turn-key air conditioning solutions for homes, medium-sized buildings such as offices and restaurants, and large-scale buildings. These offer maximum effectiveness, comply with the strictest environmental standards and meet the most avant-garde construction requirements of our time. At Panasonic we know what a great responsibility it is to install heating and cooling systems. Because offering you the best solutions in heating and cooling matters.

**PRODUCTION 100% PANASONIC**



**SERVICE PROVIDER**



**RESEARCH & DEVELOPMENT AND DESIGN**



**TESTING AND QUALITY INSURANCE**



**100%**  
**Panasonic**



## Panasonic Professional

Panasonic has an impressive range of support services for designers, specifiers, engineers and distributors working in the heating and cooling markets.

## Software

Panasonic provides bespoke software helping system designers, installers and dealers to very quickly design and size systems, create wiring diagrams and issue bills of quantities at the push of a button.



### Aquarea Designer

This program allows HVAC designers, installers and distributors to identify the correct heat pump for a particular application from Panasonic's Aquarea range, calculate the savings compared to other heat sources and very quickly calculate CO<sub>2</sub> emissions.

Using Panasonic's Aquarea Designer, projects can be developed simply and easily, by either using the Quick Design or Expert Design options. Each allows the user to build up the project data in a simple step-by-step process and choose to output reports (in either Quick or Large formats) as HTML files or as print-outs. To create these useful reports, project data is input, including:

- Heated area
- Heating requirement
- Heating flow and return temperatures
- Climate data (from a simple drop-down menu) including outdoor temperature
- Type of hot water tank, storage capacity and hot water target temperature.

Aquarea Designer will calculate the project's energy costs in terms of hot water, heating and pumping. It will show the equipment running times and calculate the COP (coefficient of performance). It then allows the designer to show clients a comparison with other equipment options such as heating by conventional gas-fired boilers, oil systems, wood, standard electric heating and electric night storage heaters. This compares running costs, initial investment costs and maintenance costs. The comparison can also be made for CO<sub>2</sub> emissions and savings.



## Panasonic

PRO Club 

### Panasonic PRO Club

Panasonic announces a new initiative for all professionals involved in the heating and cooling business - the Panasonic PRO Club ([www.panasonicproclub.com](http://www.panasonicproclub.com)). This exciting new portal provides distributors, installers, engineers and specifiers with a direct communication channel with one of the industry's major manufacturers. The website contains a wealth of information from the latest versions of Panasonic's Aquarea and Etherea Design Software, to Technical Documentation, Catalogues and Images for the company's wide range of heating and cooling systems - all in an easy to navigate and use website. Also, registered users will be able to access news regarding special promotions and take advantage of these offers, as well as access helpful business advice such as ideas and guidelines for showroom decoration or van livery featuring Panasonic logos and display material.

[www.panasonicproclub.com](http://www.panasonicproclub.com)

or connect simply with your smartphone to the proclub using this QR:



## Panasonic

PRO Academy 

### The Panasonic PRO-Academy opens its doors

Panasonic takes its responsibility to its distributors, specifiers and installers seriously and has developed a comprehensive Training Programme. The Panasonic Pro-Academy encompasses the traditional hands-on approach, as well as embracing today's technology to offer an eLearning facility available 24 hours, 7 days a week!

### New training courses cover three levels

#### Design, installation, and commissioning & trouble-shooting

Training courses include:

- Domestic applications Air to Air
- Aquarea air source heat pumps
- VRF ECOi

The courses are offered on site at Panasonic's premises across Europe as well as via the Panasonic ProClub eLearning site. The Training Centres display Panasonic's latest product range and give delegates an opportunity to get hands-on experience with the latest controllers, indoor and outdoor units from the VRF ECOi, Etherea, GHP and Aquarea ranges.

**SEASONAL  
EFFICIENCY**

PRODUCT READY FOR  
THE NEW ErP ECODESIGN  
REQUIREMENTS LOT 1



# NEW AQUAREA AIR TO WATER HEAT PUMP

**Panasonic's new Aquarea Air To Water system provides maximum efficiency and capacity even at -20 °C**

Panasonic's new Aquarea system, based on high-efficiency heat pump technology, not only heats your home and hot water, but also cools your home in summer with incredible operating performance. This creates perfect comfort whatever the weather conditions, even at outdoor temperatures as low as -20 °C.

Panasonic new heat pumps are designed in response to the new demand for low consumption housing, with high efficiency and low running costs.



\* Not all products certified. As the certification process is on-going and the list of certified products constantly changing, please check for latest details on the official websites.





## AQUAREA

### Aquarea's new Air To Water Heat Pump for residential applications

Offering capacities from 3 kW all the way through to 16 kW, the Aquarea Heat Pump Range is the widest on the market, ensuring a system is available, whatever your heating and cooling needs. Suitable for new build and refurbishment projects, the systems are cost-effective and environmentally friendly.

## ENERGY SAVING



**Inverter+ System.** The A Inverter+ system provides energy savings of up to 30% compared to non Inverter models. Both you, and nature, wins!



**Refrigerant R410A / R407C.** R410A / R407C offers optimal performance and involves no environmental cost since it does not harm the ozone layer.



**Up to -20 °C In Heating Mode.** The Heat Pumps works in heat pump mode with an outdoor temperature as low as -20 °C.

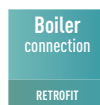

**Renovation.** Our Aquarea heat pumps can be connected to an existing or new boiler for optimum comfort even at very low outdoor temperatures.



**Solar Kit.** For even greater efficiency, our Aquarea heat pumps can be connected to photovoltaic solar panels with an optional kit.



**DHW** With Aquarea you can also heat your domestic hot water at a very low cost with the optional hot water cyclinder.



**Connectivity.** The communication port is integrated into the indoor unit and provides easy connection to, and control of, your Panasonic heat pump to your home or building management system.



**Internet Control** is a next generation system providing a user-friendly remote control of air conditioning or heat pump units from everywhere, using a simple Android or iOS smartphone, tablet or PC via internet.



**5 Years Warranty.** We guarantee the compressors in the entire range for five years.

## New Panasonic R2 Rotary Compressor

Panasonic Rotary Compressors for Room Air Conditioners have been installed in the most demanding environments around the world. Designed to withstand extreme conditions, Panasonic Rotary delivers high performance, efficiency and reliable service, no matter where you are.

Panasonic, the world's largest manufacturer of rotary compressors.

Making the world a cooler place since 1978.



## Why is the Panasonic R2 Rotary Compressor so efficient?

- 1 High Efficiency Motor** The premium silicon steel motor meets industry efficiency requirements.
- 2 Improved Lubrication of High Volume Oil Pump** The extended, high volume oil pump in conjunction with a larger capacity oil reservoir provides superior lubrication.
- 3 Accumulator has Larger Refrigerant Capacity** The larger accumulator accommodates generous refrigerant amounts needed in longer line length installations.

## R2 Compressor Value

### About R2 Compressor

Built upon 28 years of compressor design and production experience, R2 is the next generation of Rotary Compressors for residential central air conditioning. New technology improvements, enhanced materials and simple design ensure R2 compressors are reliable, efficient and quiet. The R2 Compressor delivers quality, comfort and peace of mind in homes around the world.

Panasonic's Rotary Compressors have been life tested in some of the world's most demanding environments. Proven for years many of the most demanding areas of the world, the R2 design is the compressor of choice by contractors and homeowners in these challenging climates. For the high performance that home-owners demand, R2 Rotary Compressors are the best air conditioning engines for today's residential cooling solutions.

### Leading Technology

Used in over 80% of cooling solutions globally, rotary is the world's dominant residential air conditioning compression technology. Panasonic is the leading rotary and residential AC compressor manufacturer in the world, with over 200 million compressors produced.

### Benefits

Central air conditioning delivered with a Panasonic R2 Rotary Compressor ensures a superior level of comfort at an economical cost.



#### Vane - Long Life

The special Physical Vapor Deposition (PVD) coating applied to the Vane greatly enhances the durability and life of the compressor mechanism.

#### Piston - Durable

The piston is made of unique high-grade steel that prevents wear and extends operation life.

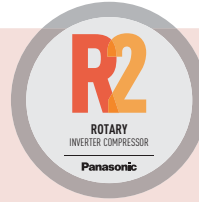

## R2 Compressors:

- Higher efficiency
- Single and Dual Piston
- R-410A refrigerant
- Compact size

**R2 rotary compressors utilize rolling piston technology.**



The R2 compressor has been tested in extreme conditions.



## FAQ

### How does a Panasonic Rotary compressor work?

R2 compressors are rolling piston rotary compressors. The heart of the rotary compressor is the cylinder which houses the piston and the vane. The vane maintains constant contact with the piston as the piston rolls along the inside wall of the cylinder. As the piston rotates, gas is compressed into an increasingly smaller area until the discharge pressure is reached, releasing gas into the shell chamber. At the same time, more gas comes in through the suction port, enabling a continuous process of suction and discharge. The simple design and symmetry of the cylinder components, combined with a special coating and premium materials, provide a highly durable and reliable product, rotation after rotation.

### What SEER range does the Panasonic Rotary compressor support?

R2 compressors are found in air conditioning products featuring the very latest technology and offering the highest efficiency on the market today. Our R2 compressors are engineered specifically for this SEER efficiency requirement. Combined with the inherently simple design of the rotary, this results in a high desirable and impressively economical solution.

### What makes Panasonic Rotary compressor so reliable?

Changes to the construction and material of internal components enables the R2 compressor to reliably operate with an above average maximum discharge

pressure. A Physical Vapor Deposition (PVD) coating on the vane, along with enhanced steel materials, significantly reduces wear and increases durability.

### What makes a Panasonic Rotary compressor so quiet?

The structure of the R2 compressor mechanism has been redesigned to increase stability and reduce vibration. Specifically, the compressor has an upper cylinder discharge, an enhanced fixed upper bearing, and reduced friction in the cylinder parts. The lower discharge and muffler in the dual piston compressors also enables lower noise levels. As a result, this new design optimises efficiency and minimises noise.

### How do R2 rotary compressors compare to scroll and reciprocating compressors?

R2 rotary compressors are very similar to some scroll compressors in overall performance, including efficiency and reliability. The simple and symmetrical key components contribute to the R2 compressor's reliability, light weight, compact size, and economical applied cost, without sacrificing the key performance requirements of high efficiency and low noise levels.

### Which refrigerants can be used with Panasonic Rotary compressor?

Panasonic has R2 Rotary Compressors available for R410A applications.



## How do you get heating and hot water from air?

### Introducing the Panasonic Aquarea – Air Source Heat Pump

An Aquarea Air Source Heat Pump captures fresh air and passes it over refrigerant-filled coils (think fridge!). The captured heat is automatically transferred to water, which is then ready for use in your heating system and for supplying all of your domestic hot water needs. Panasonic's latest technology offers you a sustainable alternative to oil, LPG and electric heating systems.

DESIGNED  
**FOR LOW  
CONSUMPTION  
HOMES**

**SEASONAL  
EFFICIENCY**

PRODUCT READY FOR  
THE NEW ErP ECODESIGN  
REQUIREMENTS LOT 1

**A**  
class pump

## New solutions



### Aquarea High Performance for low consumption houses. From 3 to 16 kW

For a house with low temperature radiators or under-floor heating, our high performance Aquarea HP is a good solution. This solution can work as a stand-alone unit or can be combined with an existing gas- or oil-fired heating system depending on requirements. This new solution is ideal for low consumption homes.



### Aquarea T-CAP. From 9 to 12 kW

If the most important aspect is to maintain nominal heating capacities even at temperatures as low as -7 °C or -20 °C\*, select the Aquarea T-CAP. This ensures that there is always enough capacity to heat the house without help from an external boiler – even at extremely low temperatures. Aquarea T-CAP always has high efficiency and high heating capacity even at extremely low temperatures. With Aquarea T-CAP, you can always enjoy high savings.

\* May need the backup heater to maintain the capacity from -15 degrees.



### Aquarea HT. From 9 to 12 kW

For a house with traditional high-temperature radiators (such as cast iron radiators), the Aquarea HT Solution is the most appropriate as the Aquarea HT provides output water temperatures of 65 °C even at outdoor temperatures as low as -20 °C. Aquarea HT is able to deliver hot water to 65 °C with the Heat Pump alone.

## Why air source heat pumps?

- Reduced heating bills and maintenance costs  
**Savings of up to £1,100 a year are possible<sup>2</sup>**
- Reduce your carbon footprint
- Simple to integrate into most heating systems
- Energy efficient alternative to oil, LPG and electric systems
- Highly compatible with other energy efficient energy sources eg solar panels

## Up to 78% energy savings\*

Panasonic's Aquarea Heat Pump provides savings of up to 78% on heating expenses compared to electrical heaters. For example, the Aquarea 9 kW system has a COP of 4.74. This is 3.74 kW more than a conventional electrical heating system which has a maximum COP of 1. This is equivalent to a 78% saving. Consumption can be further reduced by connecting photovoltaic solar panels to the Aquarea system.

## Air source heat pumps – Quick facts

- Provides sustainable heating, cooling and hot water for your home
- 30%-40% reduction in annual energy bills<sup>2</sup>
- Ideal for properties without access to mains gas
- Operates even in freezing temperatures (-20 °C).
- Externally positioned saving valuable internal living space
- Proven technology from Panasonic and already well established in other EU countries

1 Only for the 3 kW.  
2 When compared to Oil and LPG heating systems. Subject to conditions.

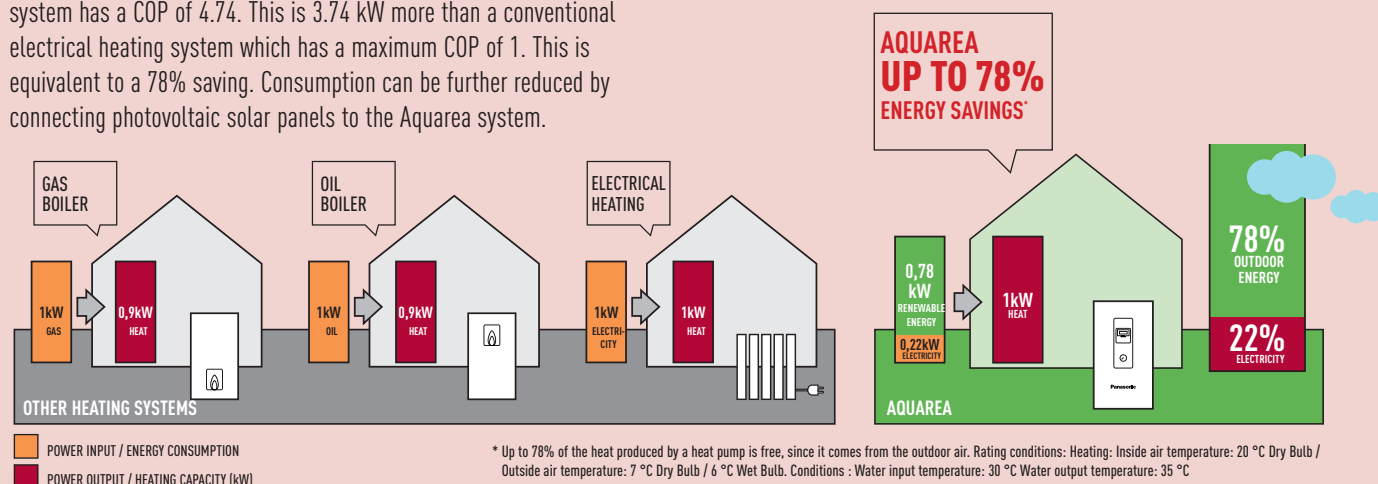

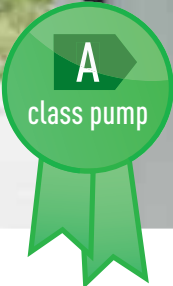

## “Green” High-efficiency heating with Panasonic’s new Air to Water Heat Pump Systems

**At the forefront of energy innovation, Aquarea is resolutely positioned as a “green” heating and air-conditioning system.**

Aquarea is part of a new generation of heating and air-conditioning systems that use a renewable, free energy source – the air – to heat or cool the home and to produce hot water. The Aquarea heat pump is a much more flexible and cost-effective alternative to a traditional fossil fuel boiler.

### **An ideal heating solution for both new and old properties:**

- A wide range from 3 to 16 kW, Single and Three Phase, Mono-Bloc and Bi-Bloc
- 3 Versions:
  - Aquarea High Performance. From 3 to 16 kW
  - Aquarea T-CAP. From 9 to 12 kW
  - Aquarea HT. From 9 to 12 kW
- The High-efficiency Heat Pump which operates at outside temperatures as low as -20 °C
- Reduces energy costs with its COP of 4.74<sup>1</sup>

- Reduces energy consumption and CO<sub>2</sub> emissions
- Provides cooling in summer
- Highly flexible:
  - Can be connected to an existing heating system
  - Can be connected to photovoltaic solar panels

We are surrounded by an endless supply of free energy: supplied by the sun and present in all spheres of our environment, the air, the ground, the groundwater...

Heat pumps enable us to recover this free, inexhaustible energy and to harness its power to heat our homes. These systems have the huge advantages of, as well as reducing your electricity bill, but also of saving fossil fuels and at the same time limiting greenhouse gas emissions<sup>2</sup>. Thus, Panasonic’s Aquarea system is an air/water heat pump system that uses energy from the outdoor air and transmits that energy via a heat exchanger to the water used to heat your home in winter. In addition, some Aquarea models can even be used to cool your house in summer time and produce hot water all year round.

1. COP: energy efficiency in heating mode. COP of 4.74 for the 9kW WH-MDF09CE8 or WH-UD09CE8 models at an outside temperature of 7 °C, and for water input and output temperatures of 30 °C and 35 °C (according to EN 14511-2).

2. We note that ADEME (French environmental and energy management agency) encourages consumers to choose heating and cooling systems that use heat pump systems.



Panasonic has designed a completely new line-up to offer the best to our customers

There are several types of heat pump available:

**The Mono-Bloc system**

This only has an outdoor unit. The installation doesn't require a refrigerated connection and is only connected to the heating and/or hot water.

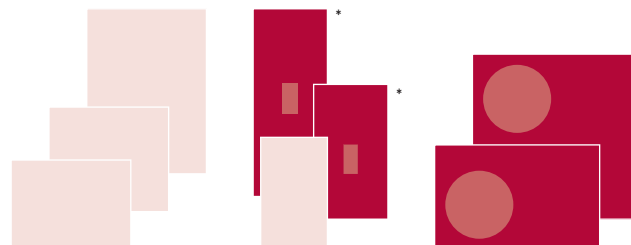

**The Bi-Bloc system**

The system connects to the heating and/or hot water system.

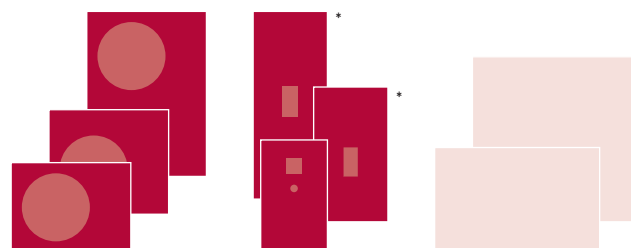

\* Tank Optional



**SEASONAL EFFICIENCY**  
 PRODUCT READY FOR THE NEW ErP ECODESIGN REQUIREMENTS LOT 1

**How does the Aquarea system work ?**

An air to water heat pump system uses heat energy present in the outdoor air to heat the house, cool it and also to produce hot water. The Aquarea system therefore uses free energy to heat or cool your home. It only consumes electricity to operate the compressor, the electronics, the pumps and in the event of very low temperatures, the electric elements. The result is very high efficiency and real energy savings.

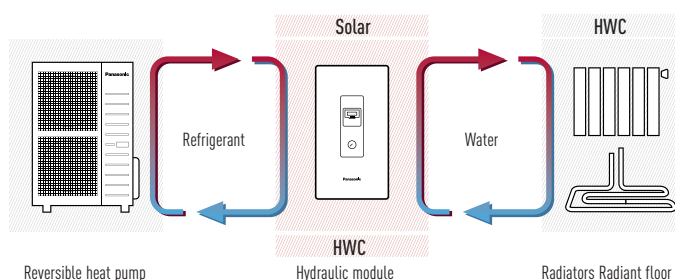

Example : with split-system

# The Aquarea heating and hot water system

The sustainable alternative to oil, LPG & Electric heating systems.

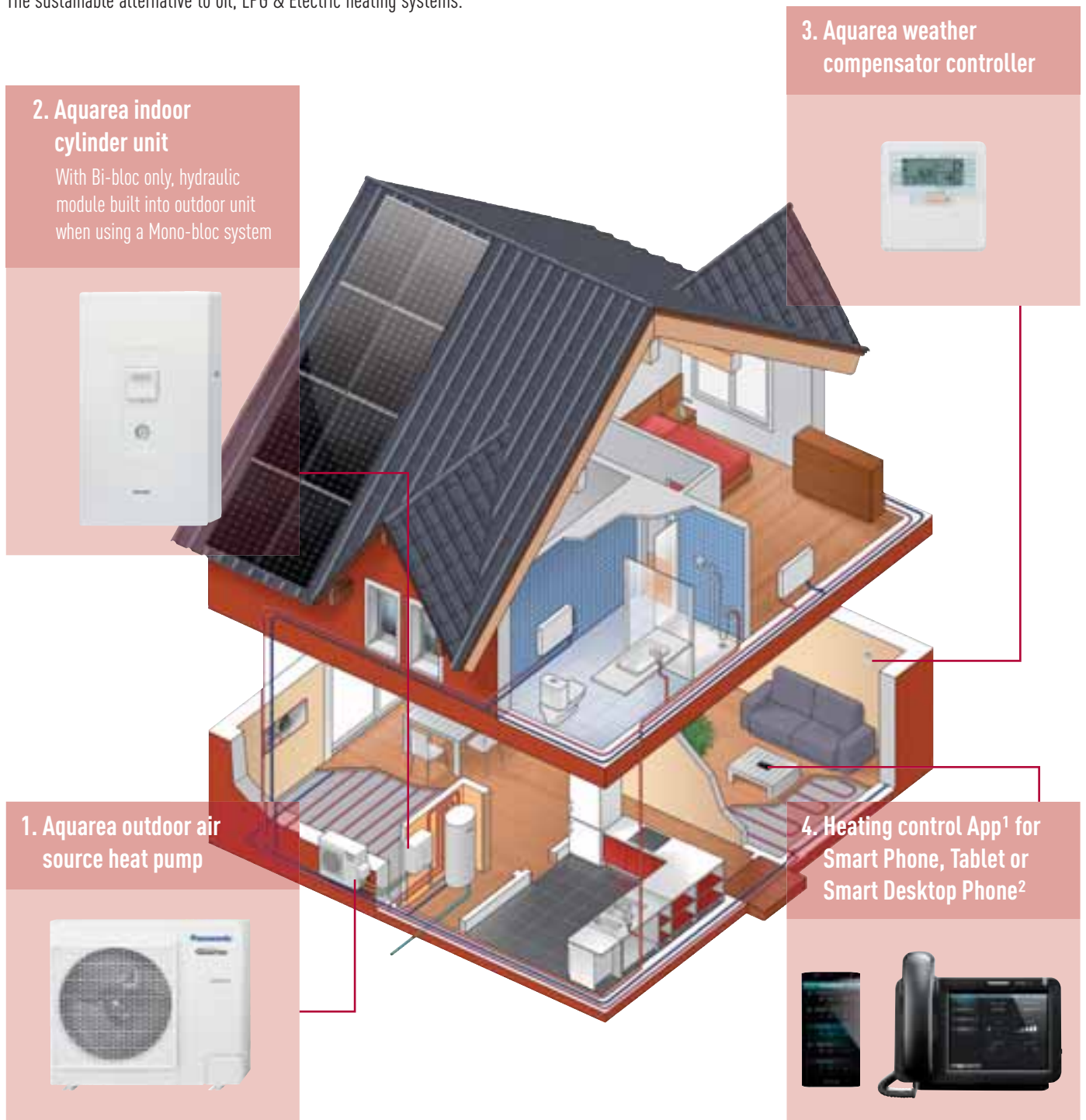

## 2. Aquarea indoor cylinder unit

With Bi-bloc only, hydraulic module built into outdoor unit when using a Mono-bloc system



## 3. Aquarea weather compensator controller



## 1. Aquarea outdoor air source heat pump



## 4. Heating control App<sup>1</sup> for Smart Phone, Tablet or Smart Desktop Phone<sup>2</sup>



### 1. Aquarea outdoor air source heat pumps

Panasonic has developed an extensive range of Air To Water heat pumps designed to efficiently convert free air into sustainable heating and hot water.

Fitted externally to your home and designed to operate in all year round weather conditions (-20 °C), it's the smart alternative to oil, LPG and electric heating systems.

### 2. Aquarea indoor cylinder unit

Using the latest technology and energy efficient installation the indoor cylinder unit provides constant hot water for domestic use.

### 3. Aquarea weather compensator controller

Built-in weather compensator allows accurate control of the inside temperature of the house based on the outdoor temperature.

### 4. Heating control App<sup>1</sup> for Smart Phone, Tablet or Smart Desktop Phone<sup>2</sup>

The heating control App allows you to control the heating and hot water system via your smart phone, tablet or computer with the same ease as if you were at home.

1. Optional.  
2. KX-UT670 Smart Desktop Phone from Panasonic.



### Aquarea T-CAP and High Performance comparison

Aquarea T-CAP maintains the nominal capacity until -15 °C (example for 12 kW)

Aquarea T-CAP and High Performance have extremely high efficiency even at -15 °C

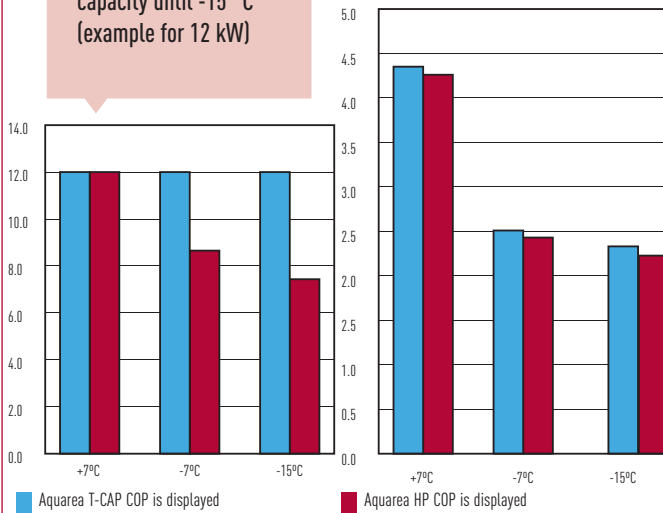

Conditions : Water input temperature: 30 °C. Water output temperature: 35 °C; outside temperature: +7 °C.

“We expect to save around 1,000 € a year on fuel costs and we’ve been able to get rid of a large ugly oil tank in the garden thanks to the new Aquarea.”

Aquarea Customer, Surrey<sup>1</sup>



\* Information provided by Aquarea customer, August 2012.



HIT Photovoltaic solar panel from Panasonic

## Heat Pump + Photovoltaic

### Photovoltaic solar panels: the best solution for big savings

Combining photovoltaic solar panels with your heat pump can help to further reduce your electrical consumption and CO<sub>2</sub> emissions. Additionally, with the unique HIT photovoltaic solar panel technology from Panasonic, you can produce more electricity per square meter, helping you to increase your energy savings still further.

### HIT cell technology

The Panasonic HIT (Heterojunction with Intrinsic Thin layer) solar cell is made of a thin mono crystalline silicon wafer surrounded by ultra-thin amorphous silicon layers. This product provides the industry’s leading performance and value using state-of-the-art manufacturing techniques.

### Environmentally-Friendly Solar Cell

More Clean Energy. HIT can generate more clean Energy than other conventional crystalline solar cells.



## What makes the Air to Water Heat Pump work

- The outdoor unit: this captures the free energy from the outdoor air and brings it into the house by means of the hydraulic module. This free energy is transported to the hydraulic module using an environmentally-friendly refrigerant gas with a high thermal exchange coefficient (R410A).
- Via the hydraulic module and control panel, temperature inside the house can be controlled and efficiency maximised. The heat exchanger transmits the energy contained in the refrigerant coming from the outdoor unit to the water used for the home's heating and hot water. The hydraulic module manages priorities in terms of heating and hot water production. In the case of the Bi-Bloc system, this hydraulic module is situated inside the property, and it is contained within outdoor unit in the Mono-Bloc system.

- The hot water cylinder heats the hot water. It is made of stainless steel, which guarantees it a very long life. It is also fitted with a 3 kW element to ensure maximum comfort when outdoor temperatures are very low. The heater, situated at the top of the cylinder, guarantees maximum efficiency and faster heat-up. A 3-way valve for the hot water cylinder connection is supplied with the hot water cylinder.
- Other necessary or optional features (not provided by Panasonic):
  - Room temperature thermostat, which can be connected to the Aquarea system to ensure optimum room temperature conditions.
  - Solar kit, to connect photovoltaic solar panels for even greater efficiency.
  - A 3 kW immersion heater is included within the hot water tank to ensure:
    - Maximum comfort
    - Maximum efficiency
    - Protection against the legionella virus

### Two or three earth leakage cut-outs

The Aquarea hydraulic module has differential cut-off ensuring maximum safety in the event of a short circuit:

- 2 differential cut-outs: 3, 5, 6 and 9 kW
- 3 differential cut-outs: 12, 14 and 16 kW





### The control panel

The control panel allows accurate temperature control based on the outdoor temperature, providing maximum efficiency and comfort. The control panel manages the heating temperature and the hot water cylinder temperature very simply.

### The hydraulic module

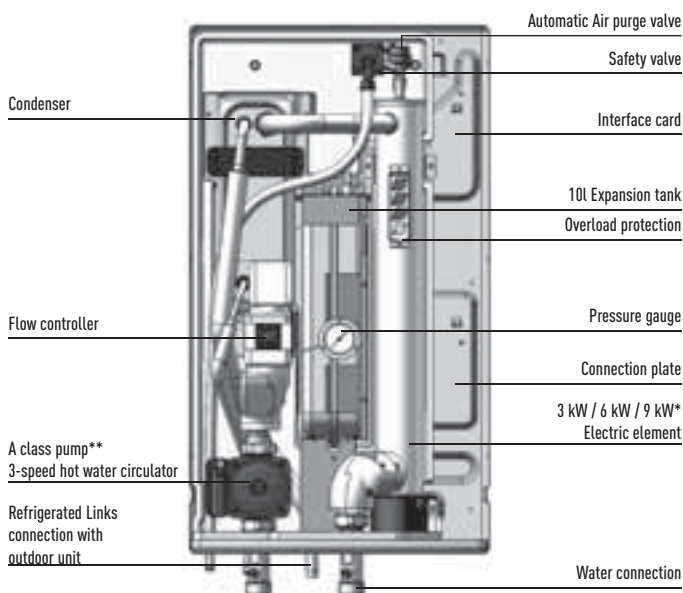
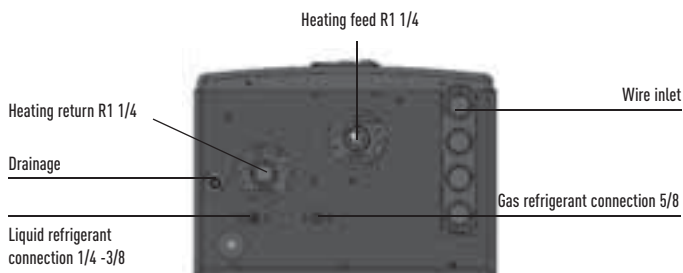

\* 3 kW for 7 and 9 kW, 6 kW for 12, 14, 16 kW Single Phase  
 9 kW for 12, 14, 16 kW Three Phase  
 \*\* only 3/5/6 kW

### Easy programming of the control panel

The primary circuit temperature is controlled based on the outdoor temperature. The control parameters are adjusted through the remote control during the commissioning of the system as is shown in the diagram below. Your heating specialist must also select the type of operation you need: heating priority or hot water cylinder priority.

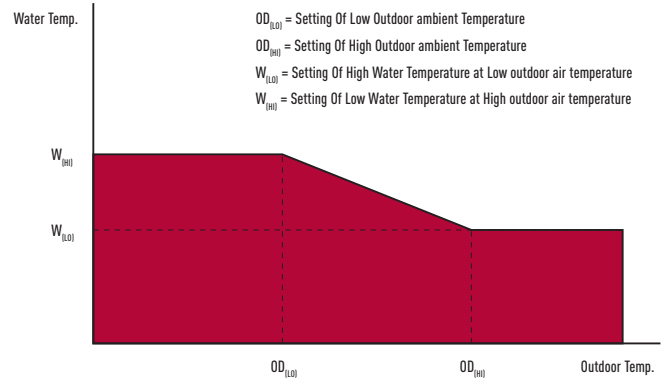

### Clear Panel for water pressure data





Down to  
**-25 °C** in  
heating mode  
OUTDOOR  
TEMPERATURE



DESIGNED  
**FOR LOW  
CONSUMPTION**  
HOMES

## New Aquarea 3 and 5 kW Bi-Bloc and 6 and 9 kW Mono-Bloc Air to Water Heat Pump

**Maximum savings, Maximum efficiency, Minimum CO<sub>2</sub> emissions, Minimum of space**

Panasonic has designed the new Aquarea Bi-Bloc and Mono-Bloc heat pumps for homes which have high performance requirements. Whatever the weather, Aquarea will always give you maximum efficiency, even at -25 °C! The New Aquarea is easy to install on new or existing installations, in all types of properties.

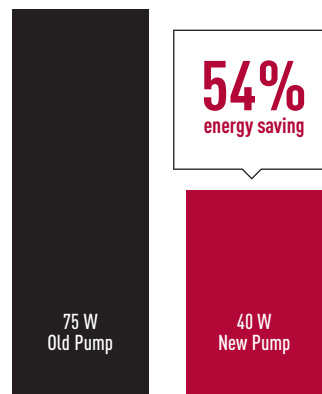

New A class pump with variable volume-flow (Dynamic Pump Control) for 6 kW Mono-Bloc  
Comparison of energy consumption - old pump vs new pump.

# 3/5 AND 6/9 kW DESIGNED FOR LOW CONSUMPTION HOMES

MAXIMUM SAVINGS, MAXIMUM EFFICIENCY,  
MINIMUM CO<sub>2</sub> EMISSIONS, MINIMUM OF SPACE

## Heating capacity adapted to suit low consumption / passivhaus

- Consistent capacity! No need to specify an oversized heat pump to heat the house at -7 °C - a 3 kW or 5 kW unit will deliver desired results!

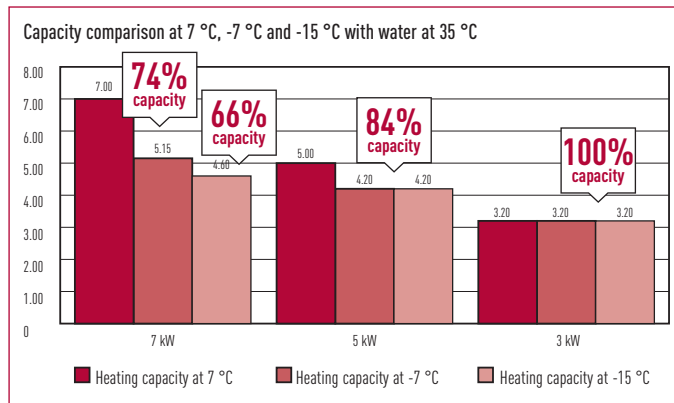

- No Backup heater needed to maintain the capacity at -7 °C, High efficiency guaranteed even at -7 °C
- Low consumption due to the R2 rotary compressor's small size.

## Technical benefits

- Super efficient: COP of 5 in the 3.2 kW!
- A Class Pump
- Special software for low consumption homes with minimum output temperature: 20 °C
- Works down to -25 °C for the 3 and 5 kW (-20 °C for the 6 and 9 kW)
- Automatic Air purge valve

## Technical elements

Mono-Bloc unit includes:

- Heat exchanger
- Variable speed pump
- 6 litre expansion vessel
- Safety valve
- Pressure gauge
- 3 kW electrical heater



## COP comparison

Electrical heater with Panasonic Heat Pump.

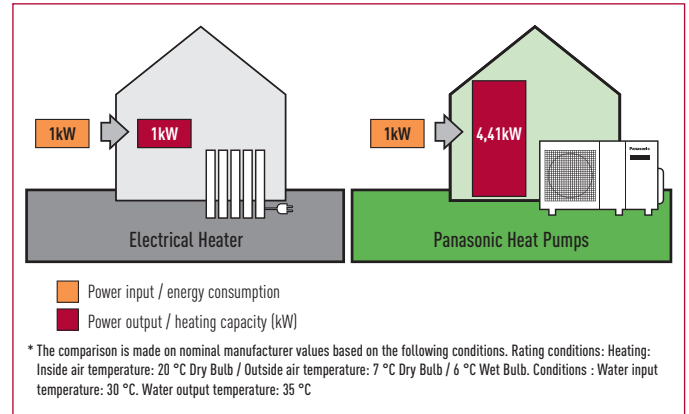

## Bi-Bloc application Examples

Low Consumption Homes + Sanitary Hot Water + Hydraulic Switch

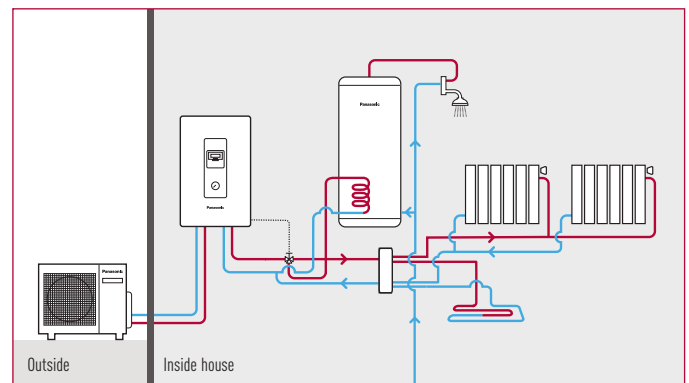

## Mono-Bloc application Examples

Heating + Sanitary Hot Water

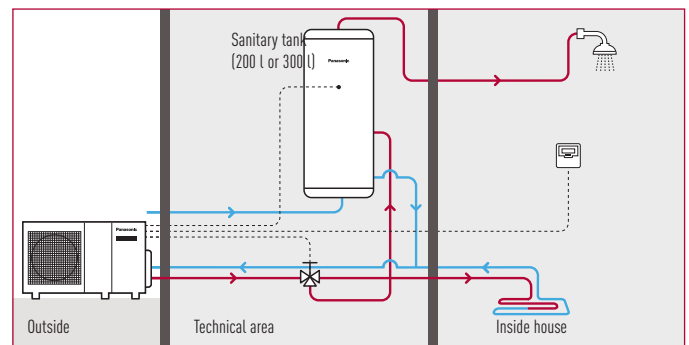

## Heating Plug and Play System

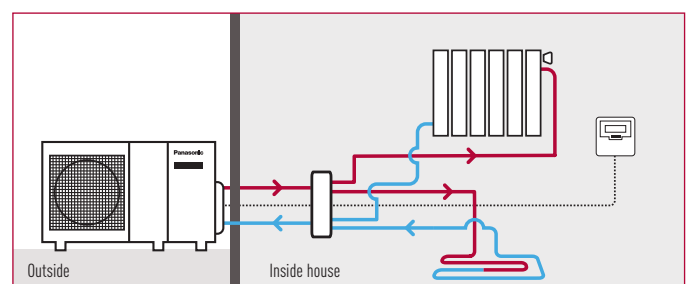



## Control & connectivity

Aware of the importance of both control and connectivity in offering the best comfort at the lowest price, Panasonic offers its customers cutting-edge technology, specially designed to ensure our Aquarea heat pump systems deliver maximum performance. You can properly manage the heat pump and perform comprehensive monitoring and control, with all of the features the remote control provides at home, from anywhere in the world thanks to the internet applications Panasonic has created for you.

## OPTIONAL



With or without built-in display



External touch display available

## NEW

## The next generation of Aquarea Manager

This new generation of smart controllers for eco-efficient heating features our versatile stand-alone controller for heating and domestic hot water.

### Panasonic offers:

Trends. Statistics. Consumption Energy Management-Optimization. Alarm. Handling + Maintenance. Complete documentation etc.

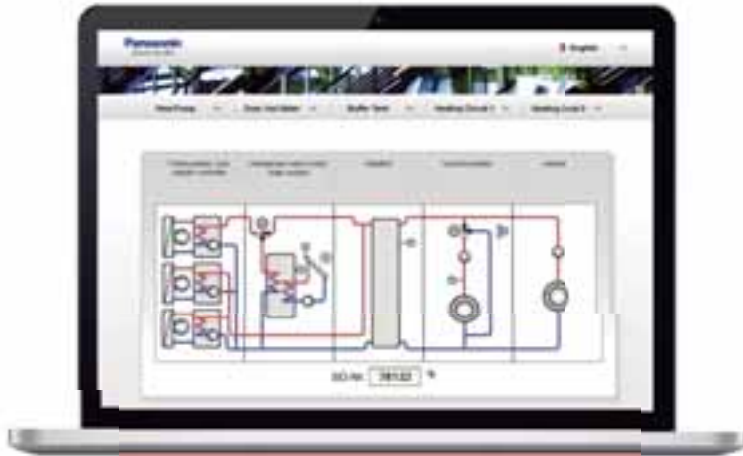

## READY STEADY GO

### Easy Installation & Easy Configuration

Ready: Pre-programmed with up to 160 applications/system diagrams

Steady: At start up - state the number of application/system diagram

Go: The controller starts working according to selected diagram

### Technical Specification

2 x Mixed Heating Circuits

- Floor screed dry program
- Cascade/bivalent controller
- Automatic switch from heating to cooling mode
- Photovoltaic / Smart Grid contact
- Night shift: - Internal Energy Manager. - Trend
- Solar collector control
- Domestic hot water priority
- Web-control
- Up to 10 languages
- Ready, Steady, Go!: With up to 155 preconfigured system diagrams.
- Ready to operate in less than 3 minutes
- Easy to startup – easy to operate
- 230 V power supply
- 7 output relays
- 2 x 0.10 V output
- 8 Sensor inputs (PT1000)
- Built-in backlit text display
- USB interface (upload, service, remote control, trend)
- RS485 interface (com. with additional heat pump)
- RS485 interface (for external display)
- External touch display available
- Large Amount of External remote control units

### Easy mounting

Simple mounting without screws in the cabinet/door or on DIN-rail. Also possible to mount directly on to the wall.

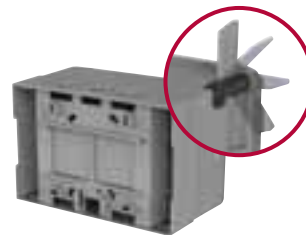

# Control your heat pump from wherever you are. Control your comfort and efficiency with the lowest energy consumption

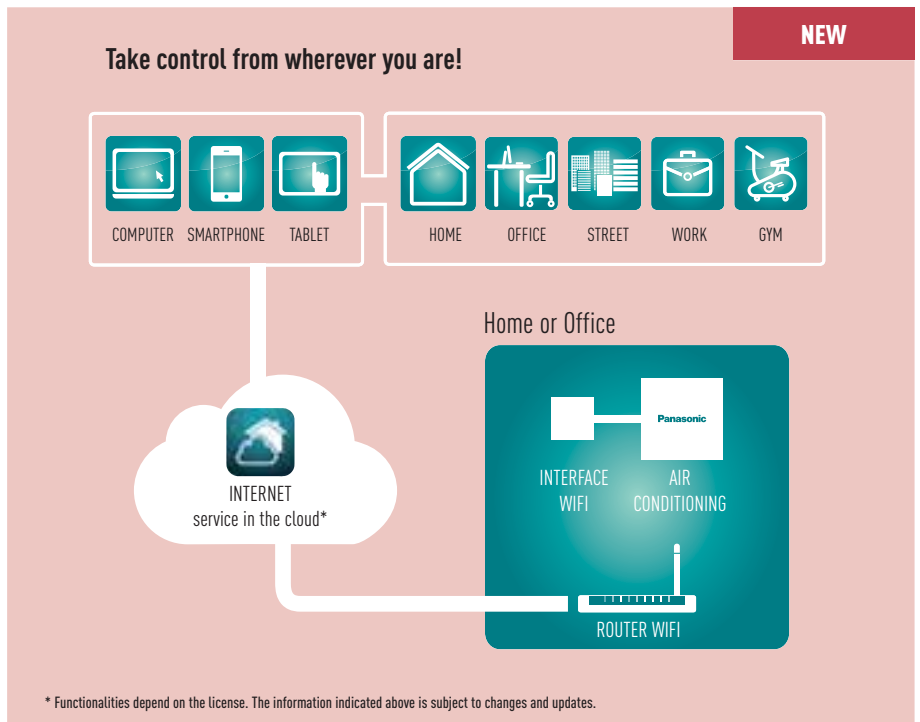

## What's Internet Control?

Internet Control is a next generation system providing user-friendly remote control of air conditioning or heat pump units from anywhere, using a simple Android or iOS smartphone, tablet or PC via internet.

### Simple Installation

Just connect the Internet Control device to the air conditioner or heat pump with the supplied wire and then link it to your WIFI Access point.

### Internet Control. Easy to install. Maximum benefit

Internet Control is underlined with the slogan "Your home in the cloud", meaning a simple and easy to handle solution has been considered for every user to manage the device, not requiring any communication or computer skills.

No servers. No adaptors. No wires. Just a small box is needed to be connected and placed close to the air conditioning indoor unit... and your smartphone, tablet or PC.

Your existing WiFi connection does the rest when you are at home. Start the App from your smartphone device, your tablet or your computer, and enjoy a new experience in comfort. And if you are out of home, just launch the App, and manage the air conditioning of your home from the cloud. An intuitive and user-friendly application on the screen of your smartphone or PC that lets you manage the air conditioning unit in the same way you do with the remote controller at home.

Internet Control can be downloaded in Apple's AppStore and Android's PlayStore.

### Control your air conditioning with the smart internet control device via smartphones, tablet, PC and smart desktop phone via internet

Offering the same functions as if you were at home or office: start/stop, Mode Operation, Set Temperature, Room Temperature etc as well as the new, advanced functionality provided by Internet Control to achieve the best comfort and efficiency with the lowest energy consumption.



## Case Study: Helen, Panasonic customer

"I was sick of heating my house in the mountains on the weekends when I couldn't go. It was a pointless and annoying expense. But now, with Internet Control, I've managed to put the rigidity of weekly programming behind me. If I go then I just put my Panasonic Aquarea heating system on. And if I don't go then I go to the cinema or the theatre with the money I've saved."



## Connectivity: Great flexibility for integration into your KNX / EnOcean / Modbus projects allows fully bi-directional monitoring and control of all the functioning parameters



Panasonic works with partners to ensure the optimum solutions for our clients. Our partner has designed a range of interfaces specifically for Panasonic to provide complete monitoring, control and full functionality of the entire Aquarea line-up from KNX, EnOcean and Modbus installations.

This connectivity solution is made by a third party company, please contact Panasonic for more information.

Easy control by BMS  
CONNECTIVITY



### Interface to connect Aquarea to KNX Reference: PAW-AW-KNX-1i

This new Aquarea-KNX interface allows full monitoring and control, bi-directionally, of all the functioning parameters of Aquarea control from KNX installations.

- Small dimensions. / Quick installation and possibility of hidden installation.
- External power not required.
- Direct connection to the unit.
- Fully KNX interoperable. Control and monitoring, from sensors or gateways, of the internal variables of the indoor unit and error codes and indication.
- Aquarea unit can be controlled simultaneously by the remote control of the Aquarea unit and by KNX devices.



KNX Any standard KNX device

### Interface to connect Aquarea to EnOcean Reference: PAW-AW-ENO-1i

This new Aquarea-EnOcean interface allows full monitoring and control, bi-directionally, of all the functioning parameters of the Aquarea control from EnOcean installations.

- Small dimensions. / Quick installation.
- External power not required.
- Direct connection to the Aquarea unit using the same parameters as on the control.
- Fully EnOcean interoperable. Control and monitoring, from sensors or gateways, of the internal variables of the indoor unit and error codes and indication.
- Aquarea unit can be controlled simultaneously by the remote control of the Aquarea unit and by EnOcean devices.

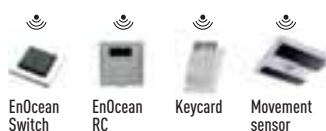

### Interface to connect Aquarea to Modbus Reference: PAW-AW-MBS-1

This new Aquarea-Modbus RTU Slave interface allows monitoring and control, fully bi-directionally, all the functioning parameters of Aquarea control from Modbus installations.

- Small dimensions. / Quick installation and possibility of hidden installation.
- External power not required.
- Direct connection to the unit.
- Fully Modbus interoperable. Control and monitoring, from any BMS or PLC Modbus Master, of internal variables of the indoor unit and error codes and indication.
- Aquarea unit can be controlled simultaneously by the remote control of the Aquarea unit and by Modbus Master device.

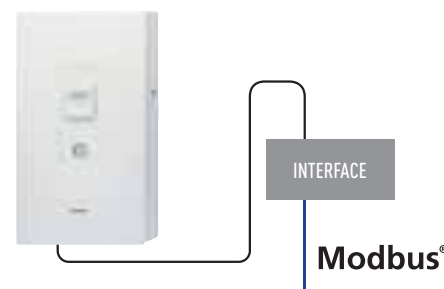

Model name	Interface
PAW-AW-KNX-1i	KNX
PAW-AW-ENO-1i	EnOcean
PAW-AW-MBS-1	Modbus RTU
PA-AW-WIFI-1	IntesisHome

# Aquarea Line-Up!



FIGURE 1 (F1)

FIGURE 2 (F2)

FIGURE 3 (F3)

FIGURE 4 (F4)

Line up				3 kW	5 kW	6 kW	7 kW	9 kW	12 kW	
Aquarea High Performance for well insulated houses	Bi-Bloc	Single Phase	Heating only	WH-SDF03E3E5 WH-UD03EE5 (F1)	WH-SDF05E3E5 WH-UD05EE5 (F1)		WH-SDF07C3E5 WH-UD07CE5-A (F3)	WH-SDF09C3E5 WH-UD09CE5-A (F3)	WH-SDF12C6E5 WH-UD12CE5-A (F4)	
			Heating and cooling	WH-SDC03E3E5 WH-UD03EE5 (F1)	WH-SDC05E3E5 WH-UD05EE5 (F1)		WH-SDC07C3E5 WH-UD07CE5-A (F3)	WH-SDC09C3E5 WH-UD09CE5-A (F3)	WH-SDC12C6E5 WH-UD12CE5-A (F4)	
	Bi-Bloc	Three Phase	Heating only					WH-SDF09C3E8 WH-UD09CE8 (F4)	WH-SDF12C9E8 WH-UD12CE8 (F4)	
			Heating and cooling					WH-SDC09C3E8 WH-UD09CE8 (F4)	WH-SDC12C9E8 WH-UD12CE8 (F4)	
	Mono-Bloc	Single Phase	Heating only			WH-MDF06E3E5 (F2)		WH-MDF09E3E5 (F2)	WH-MDF12C6E5 (F5)	WH-MDF12C6E5 (F5)
			Heating and cooling			WH-MDC06E3E5 (F2)		WH-MDC09E3E5 <sup>1</sup> (F2)	WH-MDC12C6E5 (F5)	WH-MDC12C6E5 (F5)
Mono-Bloc		Three Phase	Heating only					WH-MDF09C3E8 (F5)	WH-MDF12C9E8 (F5)	
			Heating and cooling					WH-MDC09C3E8 (F5)	WH-MDC12C9E8 (F5)	
Aquarea T-CAP for cold areas	Bi-Bloc	Single Phase	Heating only					WH-SXF09D3E5 WH-UX09DE5 (F4)	WH-SXF12D6E5 WH-UX12DE5 (F4)	
			Heating and cooling					WH-SXC09D3E5 WH-UX09DE5 (F4)	WH-SXC12D6E5 WH-UX12DE5 (F4)	
	Bi-Bloc	Three Phase	Heating only					WH-SXF09D3E8 WH-UX09DE8 (F4)	WH-SXF12D9E8 WH-UX12DE8 (F4)	
			Heating and cooling					WH-SXC09D3E8 WH-UX09DE8 (F4)	WH-SXC12D9E8 WH-UX12DE8 (F4)	
	Mono-Bloc	Single Phase	Heating only					WH-MXF09D3E5 (F5)	WH-MXF12D6E5 (F5)	
			Heating and cooling					WH-MXC09D3E5 (F5)	WH-MXC12D6E5 (F5)	
Mono-Bloc	Three Phase	Heating only					WH-MXF09D3E8 (F5)	WH-MXF12D9E8 (F5)		
		Heating and cooling					WH-MXC09D3E8 (F5)	WH-MXC12D9E8 (F5)		
Aquarea HT for retrofit	Bi-Bloc	Single Phase	Heating only					WH-SHF09D3E5 WH-UH09DE5 (F4)	WH-SHF12D6E5 WH-UH12DE5 (F4)	
			Heating only					WH-SHF09D3E8 WH-UH09DE8 (F4)	WH-SHF12D9E8 WH-UH12DE8 (F4)	
	Mono-Bloc	Single Phase	Heating only					WH-MHF09D3E5 (F5)	WH-MHF12D6E5 (F5)	
			Heating only					WH-MHF09D3E8 (F5)	WH-MHF12D9E8 (F5)	

Low connectivity : control of 3 way valve, tank heater On/Off signal, tank thermostat signal reception, On/Off from external control, weekly timer. High connectivity : Low connectivity + solar panels connection, room thermostat connection.  
 1 Available in November 2012.

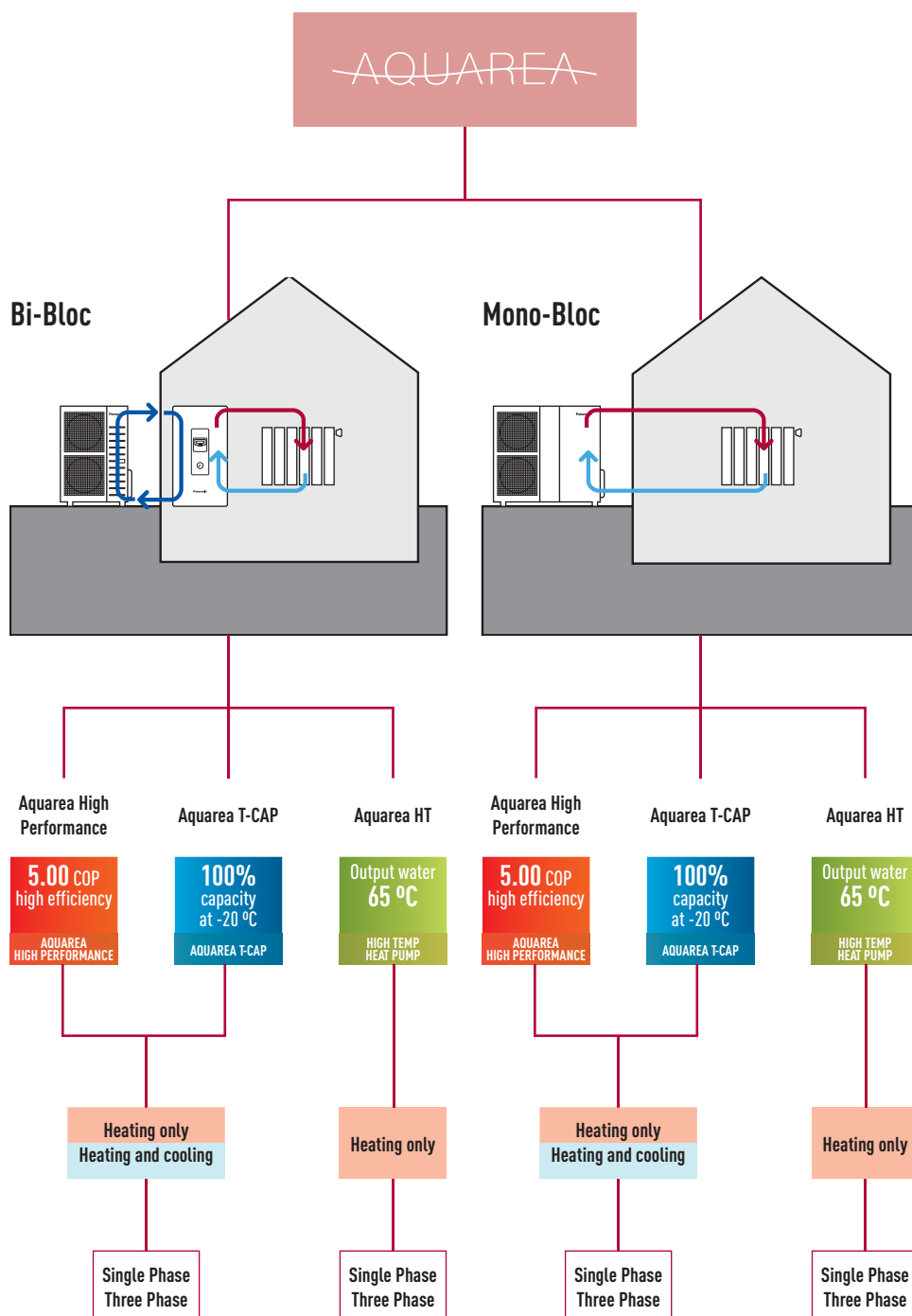

FIGURE 5 (F5)

**SEASONAL EFFICIENCY**

PRODUCT READY FOR THE NEW EPi ECODESIGN REQUIREMENTS LOT 1

14 kW	16 kW
WH-SDF14C6E5 WH-UD14CE5-A (F4)	WH-SDF16C6E5 WH-UD16CE5-A (F4)
WH-SDC14C6E5 WH-UD14CE5-A (F4)	WH-SDC16C6E5 WH-UD16CE5-A (F4)
WH-SDF14C9E8 WH-UD14CE8 (F4)	WH-SDF16C9E8 WH-UD16CE8 (F4)
WH-SDC14C9E8 WH-UD14CE8 (F4)	WH-SDC16C9E8 WH-UD16CE8 (F4)
WH-MDF14C6E5 (F5)	WH-MDF16C6E5 (F5)
WH-MDC14C6E5 (F5)	WH-MDC16C6E5 (F5)
WH-MDF14C9E8 (F5)	WH-MDF16C9E8 (F5)
WH-MDC14C9E8 (F5)	WH-MDC16C9E8 (F5)



**AQUAREA**  
**HIGH PERFORMANCE**  
 BI-BLOC SINGLE PHASE  
 HEATING ONLY - SDF  
 HEATING AND COOLING - SDC  
 3 AND 5 kW



**DESIGN FOR LOW CONSUMPTION HOMES**

MAXIMUM SAVINGS, MAXIMUM EFFICIENCY,  
 MINIMUM CO<sub>2</sub> EMISSIONS, MINIMUM OF SPACE  
 PRODUCT READY FOR THE NEW ErP ECODESIGN  
 REQUIREMENTS LOT 1

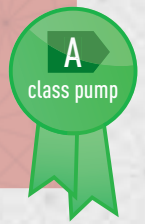

WH-UD03EE5  
 WH-UD05EE5

**The 3 and 5 kW is specially designed for low energy homes and achieves an impressive COP of 5 (on the 3.2 kW).**

Thanks to the system's high degree of technology and advanced control, it is able to maintain a high capacity and efficiency even at -7 °C and -25 °C. The Aquarea's software is optimised to the requirements of low consumption homes in order to maximise energy efficiency. Whatever the weather, Aquarea will always give you maximum efficiency, even at -25 °C. The compact design of the outdoor unit makes installation very easy.

**Technical focus**

- **NEW!** Efficient control of room temperature based on the outdoor temperature, indoor temperature using the Aquarea Manager.
- Super efficient: COP of 5 in the 3.2 kW!
- A Class Pump
- Special software for low consumption homes with minimum output temperature: 20 °C
- Works down to -25 °C
- Automatic Air purge valve
- Display of the compressor frequency

Kit	Single Phase Heating Only				Single Phase Heating and Cooling			
	KIT-WF03CE5		KIT-WF05CE5		KIT-WC03CE5		KIT-WC05CE5	
Indoor unit	WH-SDF03E3E5		WH-SDF05E3E5		WH-SDC03E3E5		WH-SDC05E3E5	
Outdoor unit	WH-UD03EE5		WH-UD05EE5		WH-UD03EE5		WH-UD05EE5	
Heating Capacity at +7 °C	kW	3.20	5.00	3.20	5.00	3.20	5.00	
COP at +7 °C with heating water at 35 °C		5.00	4.63	5.00	4.63	5.00	4.63	
Heating Capacity at +2 °C with heating water at 35 °C	kW	3.20	4.20	3.20	4.20	3.20	4.20	
COP at +2 °C with heating water at 35 °C		3.56	3.11	3.56	3.11	3.56	3.11	
Heating Capacity at -7 °C	kW	3.20	4.20	3.20	4.20	3.20	4.20	
COP at -7 °C		2.69	2.59	2.69	2.59	2.69	2.59	
Heating Capacity at -15 °C	kW	3.20	4.20	3.20	4.20	3.20	4.20	
COP at -15 °C with heating water at 35 °C		2.30	2.16	2.30	2.16	2.30	2.16	
Cooling capacity at 35 °C	kW	-	-	3.20	4.50	3.20	4.50	
EER at 35 °C with cooling water at 7/12 °C		-	-	3.08	2.69	3.08	2.69	
<b>Indoor unit</b>								
Dimensions	H x W x D	mm	892 x 502 x 353	892 x 502 x 353	892 x 502 x 353	892 x 502 x 353	892 x 502 x 353	892 x 502 x 353
Weight		kg	43	43	44	44	44	44
Water pipe connector		mm	28	28	28	28	28	28
A class Pump	No. of Speed		7	7	7	7	7	7
	Input power (Max.)	W	25	29	25	29	25	29
Heating water flow [ΔT=5 K, 35 °C]		l/min	9.2	14.3	9.2	14.3	9.2	14.3
Capacity of integrated electric heater		kW	3	3	3	3	3	3
Input Power		kW	0.64	1.08	0.64	1.08	0.64	1.08
Running and Starting current		A	3	5	3	5	3	5
Current 1 / Current 2 / Current 3		A						
Recommended Fuse		A						
Recommended power cable section		mm <sup>2</sup>						
<b>Outdoor unit</b>								
Sound pressure level		dB(A)	47	48	47	48	47	48
Sound power level		dB	65	66	65	66	65	66
Dimensions	H x W x D	mm	622 x 824 x 298	622 x 824 x 298	622 x 824 x 298	622 x 824 x 298	622 x 824 x 298	622 x 824 x 298
Weight		kg	39	39	39	39	39	39
Pipe diameter	Liquid	mm (Inch)	6.35 (1/4)	6.35 (1/4)	6.35 (1/4)	6.35 (1/4)	6.35 (1/4)	6.35 (1/4)
	Gas	mm (Inch)	12.7 (1/2)	12.7 (1/2)	12.7 (1/2)	12.7 (1/2)	12.7 (1/2)	12.7 (1/2)
Refrigerant (R410A)		kg	1.20	1.20	1.20	1.20	1.20	1.20
Pipe length range		m	3-15	3-15	3-15	3-15	3-15	3-15
Pipe length for nominal capacity		m	7	7	7	7	7	7
Pipe length for additional gas		m	10	10	10	10	10	10
Additional gas amount (R410A)		g/m	20	20	20	20	20	20
l/D&O/D Hight Difference		m	5	5	5	5	5	5
Operation range	Outdoor ambient	°C	-25 to 35	-25 to 35	-25 to 35	-25 to 35	-25 to 35	-25 to 35
	Water outlet at -2/-7/-15	°C	20 - 55	20 - 55	20 - 55	20 - 55	20 - 55	20 - 55

COP classification is at 230 V only in accordance with EU directive 2003/32/EC. Sound pressure measured at 1 m from the outdoor unit and at 1.5 m height. Performance in agreement with EN14511.

Internet Control Ready

INTERNET CONTROL

5.00 COP high efficiency

AQUAREA HIGH PERFORMANCE

High efficiency heating

INVERTER+

Environmentally friendly refrigerant

R410A

Down to -25 °C in heating mode

OUTDOOR TEMPERATURE

Boiler connection

RETROFIT

Solar panels connection

SOLAR KIT

Domestic hot water

DHW

Easy control by BMS

CONNECTIVITY

5 year compressor warranty

**AQUAREA**  
**HIGH PERFORMANCE**  
**BI-BLOC SINGLE PHASE /**  
**THREE PHASE**  
**HEATING ONLY - SDF**  
**HEATING AND COOLING - SDC**



**SEASONAL EFFICIENCY**

PRODUCT READY FOR THE NEW ErP ECODESIGN REQUIREMENTS LOT 1

The Aquarea SDF / SDC range adapts well in an existing install with a boiler backup, and in a new application with underfloor heating, low temperature radiators or even fan-coil heaters. This range can also be connected to a solar kit in order to increase efficiency and minimize the impact on the ecosystem. Finally, it is possible to connect a thermostat for even better heating control (SDF) or better heating and cooling control (SDC) and management.

- Maximum hydraulic module output temperature: 55 °C
- Works down to -20 °C
- Maximum 40 m rise between the outdoor unit and the hydraulic module
- Cooling temperature range 5-20 °C (SDC)



WH-UD07CE5-A  
WH-UD09CE5-A

WH-UD12CE5-A  
WH-UD14CE5-A  
WH-UD16CE5-A

**Technical focus**

- **NEW!** Efficient control of room temperature based on the outdoor temperature, indoor temperature using the Aquarea Manager.
- Optional Smartphone control
- Range from 7 to 16 kW, Single and Three Phase

Aquarea Manager for all Aquarea.



PAW-A2W-RTWIRED: Wired LCD room thermostat with weekly timer.



PAW-A2W-RTWIRELESS: Wireless LCD room thermostat with weekly timer.

		Single Phase (Power to indoor)					Three Phase (Power to indoor)				
Kit Heating Only		KIT-WF07CE5	KIT-WF09CE5	KIT-WF12CE5	KIT-WF14CE5	KIT-WF16CE5	KIT-WF09CE8	KIT-WF12CE8	KIT-WF14CE8	KIT-WF16CE8	
Kit Heating and Cooling		KIT-WC07CE5	KIT-WC09CE5	KIT-WC12CE5	KIT-WC14CE5	KIT-WC16CE5	KIT-WC09CE8	KIT-WC12CE8	KIT-WC14CE8	KIT-WC16CE8	
Indoor unit Heating Only		WH-SDF07C3E5	WH-SDF09C3E5	WH-SDF12C6E5	WH-SDF14C6E5	WH-SDF16C6E5	WH-SDF09C3E8	WH-SDF12C9E8	WH-SDF14C9E8	WH-SDF16C9E8	
Indoor unit Heating and Cooling		WH-SDC07C3E5	WH-SDC09C3E5	WH-SDC12C6E5	WH-SDC14C6E5	WH-SDC16C6E5	WH-SDC09C3E8	WH-SDC12C9E8	WH-SDC14C9E8	WH-SDC16C9E8	
Outdoor unit		WH-UD07CE5-A	WH-UD09CE5-A	WH-UD12CE5-A	WH-UD14CE5-A	WH-UD16CE5-A	WH-UD09CE8	WH-UD12CE8	WH-UD14CE8	WH-UD16CE8	
Heating Capacity at +7 °C with heating water at 35 °C	kW	7.0	9.0	12.0	14.0	16.0	9.0	12.0	14.0	16.0	
COP at +7 °C with heating water at 35 °C		4.40	4.10	4.67	4.50	4.23	4.74	4.67	4.50	4.23	
Heating Capacity at +2 °C with heating water at 35 °C	kW	6.55	6.70	11.40	12.40	13.00	9.00	11.40	12.40	13.00	
COP at +2 °C with heating water at 35 °C		3.30	3.10	3.40	3.32	3.25	3.53	3.40	3.32	3.25	
Heating Capacity at -7 °C with heating water at 35 °C	kW	5.15	5.90	10.00	10.70	11.40	9.00	20.00	10.70	11.40	
COP at -7 °C with heating water at 35 °C		2.65	2.50	2.70	2.62	4.47	2.81	2.70	2.62	2.55	
Heating Capacity at -15 °C with heating water at 35 °C	kW	4.60	5.90	8.90	9.50	10.30	8.30	8.90	9.50	10.30	
COP at -15 °C with heating water at 35 °C		2.30	2.20	2.18	2.35	2.33	2.55	2.43	2.35	2.33	
Cooling capacity at 35 °C with cooling water at 7 °C <sup>1</sup>	kW	6.00	7.00	10.00	11.50	12.20	7.00	10.00	11.50	12.20	
EER at 35 °C with cooling water at 7 °C <sup>1</sup>		2.61	2.41	2.78	2.61	2.54	3.11	2.82	2.61	2.54	
<b>Indoor unit</b>											
Dimensions	H x W x D	mm	892 x 502 x 353	892 x 502 x 353	892 x 502 x 353	892 x 502 x 353	892 x 502 x 353	892 x 502 x 353	892 x 502 x 353	892 x 502 x 353	
Weight		kg	43 (45 <sup>1</sup> )	43 (45 <sup>1</sup> )	49 (51 <sup>1</sup> )	49 (51 <sup>1</sup> )	50 (51 <sup>1</sup> )	51 (52 <sup>1</sup> )	51 (52 <sup>1</sup> )	51 (52 <sup>1</sup> )	
Water pipe connector			R1 1/4	R1 1/4	R1 1/4	R1 1/4	R1 1/4	R1 1/4	R1 1/4	R1 1/4	
Pump	No. of Speed		3	3	3	3	3	3	3	3	
	Input power (Max.)	W	100 (75 <sup>1</sup> )	100 (75 <sup>1</sup> )	190	190	190	190	190	190	
Heating water flow (ΔT=5 K, 35 °C)		l/min	20.1	25.8	34.4	40.1	45.9	25.8	34.4	40.1	
Capacity of integrated electric heater		kW	3	3	6	6	6	3	9	9	
Input Power	Heating / Cooling <sup>1</sup>	kW	1.59 / 2.30	2.20 / 2.90	2.57 / 3.60	3.11 / 4.40	3.78 / 4.80	1.90 / 2.25	2.57 / 3.55	3.11 / 4.40	3.78 / 4.80
	Running and Starting current Heating / Cooling <sup>1</sup>	A	7.30 / 10.40	10.10 / 13.10	11.70 / 16.10	14.10 / 19.70	17.10 / 21.50	2.90 / 3.40	3.90 / 5.30	4.70 / 6.60	5.70 / 7.20
Current 1 / Current 2 / Current 3		A	21.0 / 26.0 / -	22.9 / 26.0 / -	24.0 / 26.0 / 13.0	25.0 / 26.0 / 13.0	26.0 / 26.0 / 13.0	11.8 / 13.0 / -	8.8 / 13.0 / 13.0	9.4 / 13.0 / 13.0	9.9 / 13.0 / 13.0
Recommended Fuse		A									
Recommended power cable section		mm <sup>2</sup>									
<b>Outdoor unit</b>											
Sound pressure level		dB(A)	48	49	50	51	53	49	50	51	
Sound power level		dB	66	67	67	68	70	65	66	71	
Dimensions / Weight	H x W x D	mm / kg	795 x 900 x 320 / 66			1340 x 900 x 320 / 106					
Pipe diameter	Liquid / Gas	mm (Inch)	6.35 (1/4) / 15.88 (5/8)			9.52 (3/8) / 15.88 (5/8)					
Refrigerant (R410A)		kg	1.45	1.45	2.75	2.75	2.75	2.75	2.75	2.75	
Pipe length range		m	3 - 30	3 - 30	3 - 40	3 - 40	3 - 40	3 - 40	3 - 40	3 - 40	
Pipe length for nominal capacity		m	7	7	7	7	7	7	7	7	
Pipe length for additional gas		m	10	10	30	30	30	30	30	30	
Additional gas amount (R410A)		g/m	30	30	50	50	50	50	50	50	
I/D & O/D Height difference		m	20	20	30	30	30	30	30	30	
Operation range	Outdoor ambient	°C	-20 to 35	-20 to 35	-20 to 35	-20 to 35	-20 to 35	-20 to 35	-20 to 35	-20 to 35	
Water outlet at -2/-7/-15	Heating / Cooling <sup>1</sup>	°C	25 - 55 / 5 - 20	25 - 55 / 5 - 20	25 - 55 / 5 - 20	25 - 55 / 5 - 20	25 - 55 / 5 - 20	25 - 55 / 5 - 20	25 - 55 / 5 - 20	25 - 55 / 5 - 20	

COP classification is at 230 V only in accordance with EU directive 2003/32/EC. Sound pressure measured at 1 m from the outdoor unit and at 1.5 m height. Performance in agreement with EN14511. 1. Specifications for Heating and Cooling models.

Internet Control Ready

INTERNET CONTROL

4.74 COP high efficiency

AQUAREA HIGH PERFORMANCE

High efficiency heating

INVERTER+

Environmentally friendly refrigerant

R410A

Down to -20 °C in heating mode

OUTDOOR TEMPERATURE

Boiler connection

RETROFIT

Solar panels connection

SOLAR KIT

Domestic hot water

DHW

Easy control by BMS

CONNECTIVITY

5 year compressor warranty

INTERNET CONTROL READY: Optional.

**AQUAREA T-CAP**  
 BI-BLOC SINGLE PHASE /  
 THREE PHASE  
 HEATING ONLY - SXF  
 HEATING AND COOLING - SXC



WH-UX09DE5 WH-UX09DE8  
 WH-UX12DE5 WH-UX12DE8

**The new SXF / SXC is ideal for residential properties which don't have an external boiler and require a maintained capacity level.**

T-CAP stands for Total Capacity. This new line-up is able to maintain the same nominal capacity even at -20 °C<sup>1</sup> without the help of an electrical booster heater. T-CAP is also able to provide extremely high efficiency, whatever the outside temperature or the water temperature. The SXF / SXC adapts well in an existing install with a boiler backup, and in a new application with underfloor heating, low temperature radiators or even fan-coil heaters. This Range can also be connected to a solar kit in order to increase efficiency and minimize the impact on the ecosystem. Finally, it is possible to connect a thermostat for even better heating control (SXF) or better heating or cooling control (SXC) and management.

**Technical focus**

- **NEW!** Efficient control of room temperature based on the outdoor temperature, indoor temperature using the Aquarea Manager.
- Optional Smartphone control
- Range from 9 to 12 kW, Single and Three Phase
- Maximum hydraulic module output temperature: 55 °C
- Works down to -20 °C<sup>1</sup>
- Cooling temperature range 5-20 °C<sup>1</sup> (SXC)
- Constant capacity at outdoor temperatures down to -15 °C (at a heating water temperature of 35 °C)
- Maximum 30 m (SXF) 20 m (SXC) rise between the outdoor unit and the hydraulic module

\* A class pump for Three Phase models.  
 1. May need the backup heater to maintain the capacity from -15 degrees.

		Single Phase (Power to indoor)		Three Phase (Power to indoor)	
		KIT-WXF09DE5	KIT-WXF12DE5	KIT-WXF09DE8	KIT-WXF12DE8
		KIT-WXC09DE5	KIT-WXC12DE5	KIT-WXC09DE8	KIT-WXC12DE8
<b>Kit Heating Only</b>					
<b>Kit Heating and Cooling</b>					
<b>Indoor unit Heating Only</b>		WH-SXF09D3E5	WH-SXF12D6E5	WH-SXF09D3E8	WH-SXF12D9E8
<b>Indoor unit Heating and Cooling</b>		WH-SXC09D3E5	WH-SXC12D6E5	WH-SXC09D3E8	WH-SXC12D9E8
<b>Outdoor unit</b>		WH-UX09DE5	WH-UX12DE5	WH-UX09DE8	WH-UX12DE8
Heating Capacity at +7 °C with heating water at 35 °C	kW	9.00	12.00	9.00	12.00
COP at +7 °C with heating water at 35 °C		4.74	4.67	4.74	4.67
Heating Capacity at +2 °C with heating water at 35 °C	kW	9.00	12.00	9.00	12.00
COP at +2 °C with heating water at 35 °C		3.53	3.40	3.53	3.40
Heating Capacity at -7 °C with heating water at 35 °C	kW	9.00	12.00	9.00	12.00
COP at -7 °C with heating water at 35 °C		2.81	2.70	2.81	2.70
Heating Capacity at -15 °C with heating water at 35 °C	kW	9.00	12.00	9.00	10.00
COP at -15 °C with heating water at 35 °C		2.54	2.40	2.54	2.40
Cooling capacity at 35 °C with cooling water at 7 °C <sup>1</sup>	kW	7.00	10.00	7.00	10.00
EER at 35 °C with cooling water at 7 °C <sup>1</sup>		3.11	2.78	3.11	2.78
<b>Indoor unit</b>					
Dimensions	H x W x D	mm	892 x 502 x 353	892 x 502 x 353	892 x 502 x 353
Weight		kg	47 (48 <sup>1</sup> )	49 (51 <sup>1</sup> )	51 (52 <sup>1</sup> )
Water pipe connector			R 1 ½	R 1 ½	R 1 ½
Pump	No. of Speed		3	3	7
	Input power (Max.)	W	190	190	39
Heating water flow (ΔT=5 K, 35 °C)		l/min	25.8	34.4	25.8
Capacity of integrated electric heater		kW	3	6	3
Input Power		kW	1.90	2.57	1.90
Starting Current		A	8.8 (10.4 <sup>1</sup> )	11.9 (16.7 <sup>1</sup> )	2.9 (3.4 <sup>1</sup> )
Current 1 / Current 2 / Current 3		A	25.0 / 26.0 / -	29.0 / 26.0 / 13.0	14.7 / 13.0 / -
Recommended Fuse		A			
Recommended power cable section		mm <sup>2</sup>			
<b>Outdoor unit</b>					
Sound pressure level		dB(A)	49	50	49
Sound power level		dB	66	67	66
Dimensions / Weight	H x W x D	mm / kg	1340 x 900 x 320 / 107	1340 x 900 x 320 / 107	1340 x 900 x 320 / 110
Pipe diameter	Liquid / Gas	mm (Inch)	9.52 (3/8) / 15.88 (5/8)	9.52 (3/8) / 15.88 (5/8)	9.52 (3/8) / 15.88 (5/8)
Refrigerant (R410A)		kg	3.10	3.10	3.10
Pipe length range		m	3 - 30	3 - 30	3 - 30
Pipe length for nominal capacity		m	7	7	7
Pipe length for additional gas		m	15	15	15
Additional gas amount (R410A)		g/m	50	50	50
l/D&O/D High Difference		m	20	20	20
Operation range	Outdoor ambient	°C	-20 to 35	-20 to 35	-20 to 35
Water outlet at -2/-7/-15	Heating / Cooling <sup>1</sup>	°C	25 - 55 / 5 - 20	25 - 55 / 5 - 20	25 - 55 / 5 - 20

COP classification is at 230 V only in accordance with EU directive 2003/32/EC. Sound pressure measured at 1 m from the outdoor unit and at 1.5 m height. Performance in agreement with EN14511. 1. Specifications for Heating and Cooling models.

Internet Control Ready

INTERNET CONTROL

100% capacity at -20 °C

AQUAREA T-CAP

High efficiency heating

INVERTER+

Environmentally friendly refrigerant

R410A

Down to -20 °C in heating mode

OUTDOOR TEMPERATURE

Boiler connection

RETROFIT

Solar panels connection

SOLAR KIT

Domestic hot water

DHW

Easy control by BMS

CONNECTIVITY

5 year compressor warranty

**AQUAREA HT**  
**BI-BLOC SINGLE PHASE /**  
**THREE PHASE**  
**HEATING ONLY - SHF**



**SEASONAL EFFICIENCY**  
 PRODUCT READY FOR THE NEW ErP ECODESIGN REQUIREMENTS LOT 1

For a house with high temperature radiators (for example, cast iron radiators), the Aquarea High Temperature Solution is most suited as it provides output water temperatures of 65 °C even at -20 °C.

Aquarea HT is able to deliver water heated to 65 °C with the Heat Pump alone.

- Maximum hydraulic module output temperature: 65 °C
- Works down to -20 °C
- Maximum 30 m rise between the outdoor unit and the hydraulic module



WH-UH09DE5 WH-UH09DE8  
 WH-UH12DE5 WH-UH12DE8

**Technical focus**

- **NEW!** Efficient control of room temperature based on the outdoor temperature, indoor temperature using the Aquarea Manager.
- Optional Smartphone control
- Range from 9 to 12 kW, Single and Three Phase

**Aquarea Manager for all Aquarea.**



PAW-A2W-RTWIRED: Wired LCD room thermostat with weekly timer.



PAW-A2W-RTWIRESLESS: Wireless LCD room thermostat with weekly timer.

Kit	Single Phase (Power to indoor)		Three Phase (Power to indoor)	
	KIT-WHF09DE5	KIT-WHF12DE5	WH-SHF09D3E8	KIT-WHF12DE8
Indoor unit	WH-SHF09D3E5*	WH-SHF12D6E5*	WH-SHF09D3E8*	WH-SHF12D9E8*
Outdoor unit	WH-UH09DE5	WH-UH12DE5	WH-UH09DE8	WH-UH12DE8
Heating Capacity at +7 °C with heating water at 35 °C	kW 9.17	11.58	9.00	12.00
COP at +7 °C with heating water at 35 °C	4.79	4.29	4.55	4.40
Heating Capacity at +2 °C with heating water at 35 °C	kW 8.90	11.48	9.00	12.00
COP at +2 °C with heating water at 35 °C	3.53	3.27	3.40	3.23
Heating Capacity at -7 °C with heating water at 35 °C	kW 9.78	11.91	9.00	12.00
COP at -7 °C with heating water at 35 °C	2.65	2.61	2.70	2.50
Heating Capacity at -15 °C with heating water at 35 °C	kW 9.02	11.20	9.00	12.00
COP at -15 °C with heating water at 35 °C	2.41	2.18	2.40	2.15
Heating Capacity at +7 °C with heating water at 65 °C	kW 9.00	12.00	9.00	12.00
COP at +7 °C with heating water at 65 °C	2.25	2.20	2.25	2.20
Heating Capacity at +2 °C with heating water at 65 °C	kW 9.00	10.30	9.00	10.30
COP at +2 °C with heating water at 65 °C	1.88	1.83	1.88	1.83
Heating Capacity at -7 °C with heating water at 65 °C	kW 8.90	9.60	8.90	9.60
COP at -7 °C with heating water at 65 °C	1.62	1.61	1.64	1.61
Heating Capacity at -15 °C with heating water at 65 °C	kW 7.80	8.00	7.80	8.00
COP at -15 °C with heating water at 65 °C	1.32	1.30	1.32	1.30
<b>Indoor unit</b>				
Dimensions / Weight	H x W x D	mm / kg	892 x 502 x 353 / 50	892 x 502 x 353 / 52
Water pipe connector			R 1 1/4	R 1 1/4
Pump	No. of Speed		3	3
	Input Power (Max.)	W	190	190
Heating water flow (ΔT=5 K, 35 °C)		l/min	25.8	34.4
Capacity of integrated electric heater		kW	3	6
Input Power		kW	1.98	2.73
Running and Starting current		A	9.5	13.0
Current 1 / Current 2 / Current 3		A	28.5 / 26.0 / -	29.0 / 26.0 / 13.0
Recommended Fuse		A		
Recommended power cable section		mm²		
<b>Outdoor unit</b>				
Sound pressure level / Sound power level	dB(A) / dB		49 / 53	50 / 53
Dimensions / Weight	H x W x D	mm / kg	1340 x 900 x 320 / 105	1340 x 900 x 320 / 105
Pipe diameter	Liquid / Gas	mm (Inch)	9.52 (3/8) / 15.88 (5/8)	9.52 (3/8) / 15.88 (5/8)
Refrigerant (R407C)		kg	2.99	2.99
Pipe length range		m	3 - 30	3 - 30
Pipe length for nominal capacity		m	7	7
Pipe length for additional gas		m	15	15
Additional gas amount (R407C)		g/m	70	70
I/D&O/D Height Difference		m	20	20
Operation range	Outdoor ambient	°C	-20 to 35	-20 to 35
Water outlet at -2/-7/-15		°C	25 - 65	25 - 65

<b>Internet Control Ready</b>	<b>Output water 65 °C</b>	<b>High efficiency heating</b>	<b>Environmentally friendly refrigerant</b>	<b>Down to -20 °C in heating mode</b>	<b>Boiler connection</b>	<b>Solar panels connection</b>	<b>Domestic hot water</b>	<b>Easy control by BMS</b>	<b>5 year compressor warranty</b>
INTERNET CONTROL	HIGH TEMP HEAT PUMP	INVERTER+	R407C	OUTDOOR TEMPERATURE	RETROFIT	SOLAR KIT	DHW	CONNECTIVITY	

COP classification is at 230 V only in accordance with EU directive 2003/32/EC. Sound pressure measured at 1 m from the outdoor unit and at 1.5 m height. Performance in agreement with EN14511.  
 \* Tentative specifications.

**AQUAREA**  
**HIGH PERFORMANCE**  
 MONO-BLOC SINGLE PHASE  
 HEATING ONLY - MDF  
 HEATING AND COOLING - MDC  
 6 AND 9 kW



**DESIGN FOR LOW CONSUMPTION HOMES**

MAXIMUM SAVINGS, MAXIMUM EFFICIENCY,  
 MINIMUM CO<sub>2</sub> EMISSIONS, MINIMUM OF SPACE  
 PRODUCT READY FOR THE NEW ErP ECODESIGN  
 REQUIREMENTS LOT 1

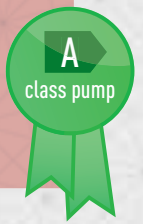

**Panasonic has designed the new Aquarea Mono-Bloc heat pump for houses which have high performance requirements but limited space to install the outdoor unit.**

Whatever the weather, Aquarea will always give you maximum efficiency, even at -20 °C. The Mono-Bloc is easy to install in new and existing residential properties.

**Technical focus**

- **NEW!** Efficient control of room temperature based on the outdoor temperature, indoor temperature using the Aquarea Manager.
- Optional Smartphone control
- Range from 6 and 9 kW, Single Phase
- Maximum hydraulic module output temperature: 55 °C
- Works down to -20 °C
- Plug and play system

		Single Phase			
		WH-MDF06E3E5 <sup>1</sup>	WH-MDF09E3E5 <sup>1</sup>	WH-MDC06E3E5 <sup>1 2</sup>	WH-MDC09E3E5 <sup>1 2</sup>
Heating Capacity at +7 °C with heating water at 35 °C	kW	6.00	9.00	6.00	9.00
COP at +7 °C with heating water at 35 °C		4.48	4.15	4.48	4.15
Heating Capacity at +2 °C with heating water at 35 °C	kW	5.00	7.45	5.00	7.45
COP at +2 °C with heating water at 35 °C		3.45	3.14	3.45	3.14
Heating Capacity at -7 °C with heating water at 35 °C	kW	5.15	7.70	5.15	7.70
COP at -7 °C with heating water at 35 °C		2.68	2.12	2.68	2.12
Heating Capacity at -15 °C with heating water at 35 °C	kW	5.90	7.60	5.90	7.60
COP at -15 °C with heating water at 35 °C		2.21	2.01	2.21	2.01
Cooling capacity at 35 °C with cooling water at 7 °C	kW	-	-	5.50	7.00
EER at 35 °C with cooling water at 7 °C		-	-	2.74	2.44
Sound pressure level	dB(A)	47	49	47	49
Sound power level	dB	65	67	65	67
Dimensions	H x W x D	mm 865 x 1283 x 320	865 x 1283 x 320	865 x 1283 x 320	865 x 1283 x 320
Weight	kg	112	112	112	112
Water pipe connector		R 1 ¼	R 1 ¼	R 1 ¼	R 1 ¼
Pump	No. of Speed	7	7	7	7
	Input Power	W 56	66	56	66
Water Flow (ΔT=5 K, 35 °C)	l/min	17.2	25.8	17.2	25.8
Capacity of integrated electric heater	kW	3.00	3.00	3.00	3.00
Input Power at +7 °C	kW	1.34	2.17	1.34	2.17
Running and Starting current at +7 °C	A	6.1	9.9	6.1	9.9
Current 1	A				
Current 2	A				
Current 3	A				
Recommended Fuse	A				
Recommended power cable section	mm <sup>2</sup>				
Operation range	Outdoor ambient	°C -20 to 35	-20 to 35	-20 to 35	-20 to 35
Water outlet at -2/-7/-15	°C	20 - 55	20 - 55	20 - 55	20 - 55

COP classification is at 230 V only in accordance with EU directive 2003/32/EC.

Sound pressure measured at 1 m from the outdoor unit and at 1.5 m height.

Performance in agreement with EN14511.

1. Available from February 2013.

2. Preliminary specifications.

Internet Control Ready

INTERNET CONTROL READY: Optional.

4.48 COP high efficiency

AQUAREA HIGH PERFORMANCE

High efficiency heating

INVERTER+

Environmentally friendly refrigerant

R410A

Down to -20 °C in heating mode

OUTDOOR TEMPERATURE

Easy control by BMS

CONNECTIVITY

5 year compressor warranty



**AQUAREA**  
**HIGH PERFORMANCE**  
**MONO-BLOC SINGLE PHASE /**  
**THREE PHASE**  
**HEATING ONLY - MDF**  
**HEATING AND COOLING - MDC**



**SEASONAL EFFICIENCY**

PRODUCT READY FOR  
THE NEW ErP ECODESIGN  
REQUIREMENTS LOT 1

The Aquarea MDF / MDC range adapts well in an existing installation with a boiler backup, and in a new application with underfloor heating, low temperature radiators or even fan-coil heaters. This range can also be connected to a solar kit in order to increase efficiency and minimize the impact on the ecosystem. Finally, it is possible to connect a thermostat for even better heating (MDF) or better heating and cooling control (MDC) control and management.

- Range from 9 to 16 kW, Single and Three Phase
- Maximum hydraulic module output temperature: 55 °C
- Works down to -20 °C
- Cooling temperature range 5-20 °C (MDC)

#### Technical focus

- **NEW!** Efficient control of room temperature based on the outdoor temperature, indoor temperature using the Aquarea Manager.
- Optional Smartphone control

Aquarea Manager for all Aquarea.



PAW-A2W-RTWIRED: Wired LCD room thermostat with weekly timer.



PAW-A2W-RTWIRESLESS: Wireless LCD room thermostat with weekly timer.

		Single Phase			Three Phase				
		WH-MDF12C6E5	WH-MDF14C6E5	WH-MDF16C6E5	WH-MDF09C3E8	WH-MDF12C9E8	WH-MDF14C9E8	WH-MDF16C9E8	
		WH-MDC12C6E5	WH-MDC14C6E5	WH-MDC16C6E5	WH-MDC09C3E8	WH-MDC12C9E8	WH-MDC14C9E8	WH-MDC16C9E8	
Outdoor unit Heating Only									
Outdoor unit Heating and Cooling									
Heating Capacity at +7 °C with heating water at 35 °C		kW	12.00	14.00	16.00	9.00	12.00	14.00	16.00
COP at +7 °C with heating water at 35 °C			4.67	4.50	4.23	4.74	4.67	4.50	4.23
Heating Capacity at +2 °C with heating water at 35 °C		kW	11.40	12.40	13.00	9.00	11.40	12.40	13.00
COP at +2 °C with heating water at 35 °C			3.41	3.32	3.25	3.53	3.41	3.32	3.55
Heating Capacity at -7 °C with heating water at 35 °C		kW	10.00	10.70	11.40	9.00	10.00	10.70	11.40
COP at -7 °C with heating water at 35 °C			2.70	2.68	2.65	2.81	2.70	2.68	2.65
Heating Capacity at -15 °C with heating water at 35 °C		kW	8.90	9.50	10.30	8.30	8.90	9.50	10.30
COP at -15 °C with heating water at 35 °C			2.43	2.35	2.33	2.55	2.43	2.35	2.33
Cooling capacity at 35 °C with cooling water at 7 °C <sup>1</sup>		kW	10.00	11.50	12.20	7.00	10.00	11.50	12.20
EER at 35 °C with cooling water at 7 °C <sup>1</sup>			2.78	2.61	2.51	3.11	2.78	2.61	2.54
Sound pressure level		dB(A)	50	51	53	49	50	51	53
Sound power level		dB	63	63	64	60	62	64	65
Dimensions		H x W x D	mm	1410 x 1283 x 320	1410 x 1283 x 320	1410 x 1283 x 320	1410 x 1283 x 320	1410 x 1283 x 320	1410 x 1283 x 320
Weight		kg	153	153	153	157	157	157	
Water pipe connector			R 1 1/4	R 1 1/4	R 1 1/4	R 1 1/4	R 1 1/4	R 1 1/4	
Pump		No. of Speed	3	3	3	3	3	3	
		Input power (Max.)	W	190	190	190	190	190	
Heating water flow (ΔT=5 K, 35 °C)		l/min	34.4	40.1	45.9	25.8	34.4	40.1	45.9
Capacity of integrated electric heater		kW	6	6	6	3	9	9	
Input Power		Heating	kW	2.57	3.11	3.78	1.90	2.57	3.11
		Cooling <sup>1</sup>	kW	3.60	4.40	4.80	2.25	3.60	4.40
Running and Starting current		Heating	A	11.6	14.1	17.1	2.9	3.9	4.7
		Cooling <sup>1</sup>	A	16.1	19.7	21.5	3.4	5.3	6.6
Current 1		A	24.0	25.0	26.0	11.8	8.8	9.4	
Current 2		A	26.0	26.0	26.0	13.0	13.0	13.0	
Current 3		A	13.0	13.0	13.0		13.0	13.0	
Recommended Fuse		A							
Recommended power cable section		mm <sup>2</sup>							
Operation range		Outdoor ambient	°C	-20 to 35	-20 to 35	-20 to 35	-20 to 35	-20 to 35	
		Heating / Cooling <sup>1</sup>	°C	25 - 55 / 5 - 20	25 - 55 / 5 - 20	25 - 55 / 5 - 20	25 - 55 / 5 - 20	25 - 55 / 5 - 20	

COP classification is at 230 V only in accordance with EU directive 2003/32/EC. Sound pressure measured at 1 m from the outdoor unit and at 1.5 m height. Performance in agreement with EN14511.

1. Specifications for Heating and Cooling models.



INTERNET CONTROL READY: Optional.

**AQUAREA T-CAP**  
**MONO-BLOC SINGLE PHASE /**  
**THREE PHASE**  
**HEATING ONLY - MXF**  
**HEATING AND COOLING - MXC**



**SEASONAL EFFICIENCY**  
 PRODUCT READY FOR THE NEW ErP ECODESIGN REQUIREMENTS LOT 1

**The new MXF / MXC is ideal for residential properties which don't have an external boiler and require a maintained capacity level.**

T-CAP stands for Total Capacity. This new line-up is able to maintain the same nominal capacity even at -20 °C\* without the help of an electrical booster heater. T-CAP is also able to provide extremely high efficiency, whatever the outside temperature or the water temperature. The MXF adapts well in an existing install with a boiler backup, and in a new application with underfloor heating, low temperature radiators or even fan-coil heaters. This range can also be connected to a solar kit in order to increase efficiency and minimize the impact on the ecosystem. Finally, it is possible to connect a thermostat for even better heating control (MXF) or better heating or cooling control (MXC) and management.

**Technical focus**

- **NEW!** Efficient control of room temperature based on the outdoor temperature, indoor temperature using the Aquarea Manager.
- Optional Smartphone control
- Range from 9 to 12 kW, Single and Three Phase
- Maximum hydraulic module output temperature: 55 °C
- Works down to -20 °C\*
- Cooling temperature range 5-20 °C\* (MXC)

\* May need the backup heater to maintain the capacity from -15 degrees.

03.01.13

	Single Phase		Three Phase	
Outdoor unit Heating Only	WH-MXF09D3E5	WH-MXF12D6E5	WH-MXF09D3E8	WH-MXF12D9E8
Outdoor unit Heating and Cooling	WH-MXC09D3E5	WH-MXC12D6E5	WH-MXC09D3E8	WH-MXC12D9E8
Heating Capacity at +7 °C with heating water at 35 °C	kW 9.33	12.08	9.00	12.00
COP at +7 °C with heating water at 35 °C	4.89	4.73	4.74	4.67
Heating Capacity at +2 °C with heating water at 35 °C	kW 9.22	11.76	9.00	12.00
COP at +2 °C with heating water at 35 °C	3.66	3.32	3.53	3.40
Heating Capacity at -7 °C with heating water at 35 °C	kW 9.03	11.63	9.00	12.00
COP at -7 °C with heating water at 35 °C	2.91	2.60	2.81	2.70
Heating Capacity at -15 °C with heating water at 35 °C	kW 9.23	12.06	9.00	12.00
COP at -15 °C with heating water at 35 °C	2.50	2.32	2.54	2.40
Cooling capacity at 35 °C with cooling water at 7 °C <sup>1</sup>	kW 7.00	10.00	7.00	10.00
EER at 35 °C with cooling water at 7 °C <sup>1</sup>	3.11	2.78	3.11	2.78
Sound pressure level	dB(A) 49	50	49	50
Sound power level	dB 60	60	66.1	67.1
Dimensions	H x W x D mm 1410 x 1283 x 320	1410 x 1283 x 320	1410 x 1283 x 320	1410 x 1283 x 320
Weight	kg 155	155	158	158
Water pipe connector	R 1 1/4	R 1 1/4	R 1 1/4	R 1 1/4
Pump	No. of Speed	3	3	3
	Input power (Max.)	W 190	190	190
Heating water flow [ΔT=5 K, 35 °C]	l/min 25.8	34.4	25.8	34.4
Capacity of integrated electric heater	kW 3	6	3	9
Input Power	kW 1.90	2.57	1.90	2.57
Starting Current	A 8.8 (10.4 <sup>1</sup> )	11.9 (16.7 <sup>1</sup> )	2.9	3.9
Current 1	A 25.0	29.0	14.7	11.9
Current 2	A 26.0	26.0	13.0	13.0
Current 3	A	13.0		13.0
Recommended Fuse	A			
Recommended power cable section	mm <sup>2</sup>			
Operation range	Outdoor ambient °C -20 to 35	-20 to 35	-20 to 35	-20 to 35
Water outlet at -2/-7/-15	Heating / Cooling <sup>1</sup> °C 25 - 55 / 5 - 20	25 - 55 / 5 - 20	25 - 55 / 5 - 20	25 - 55 / 5 - 20

COP classification is at 230 V only in accordance with EU directive 2003/32/EC. Sound pressure measured at 1 m from the outdoor unit and at 1.5 m height. Performance in agreement with EN14511.  
 1. Specifications for Heating and Cooling models.

Internet Control Ready

INTERNET CONTROL

100% capacity at -20 °C

AQUAREA T-CAP

High efficiency heating

INVERTER+

Environmentally friendly refrigerant

R410A

Down to -20 °C in heating mode

OUTDOOR TEMPERATURE

Boiler connection

RETROFIT

Solar panels connection

SOLAR KIT

Domestic hot water

DHW

Easy control by BMS

CONNECTIVITY

5 year compressor warranty

## AQUAREA HT

### MONO-BLOC SINGLE PHASE / THREE PHASE

### HEATING ONLY - MHF



For a house with high temperature radiators (for example, cast iron radiators), the Aquarea High Temperature Solution is most suited as it provides output water temperatures of 65 °C even at -20 °C.

Aquarea HT is able to deliver 65 °C with the Heat Pump alone.

- Optional Smartphone control
- Range from 9 to 12 kW, Single and Three Phase
- Maximum hydraulic module output temperature: 65 °C
- Works down to -20 °C

#### Technical focus

- **NEW!** Efficient control of room temperature based on the outdoor temperature, indoor temperature using the Aquarea Manager.

Aquarea Manager for all Aquarea.



PAW-A2W-RTWIRED: Wired LCD room thermostat with weekly timer.



PAW-A2W-RTWIRELESS: Wireless LCD room thermostat with weekly timer.

Outdoor unit		Single Phase		Three Phase	
		WH-MHF09D3E5*	WH-MHF12D6E5*	WH-MHF09D3E8*	WH-MHF12D9E8*
Heating Capacity at +7 °C with heating water at 35 °C	kW	9.00	12.00	9.00	12.00
COP at +7 °C with heating water at 35 °C		4.55	4.40	4.55	4.40
Heating Capacity at +2 °C with heating water at 35 °C	kW	9.00	12.00	9.00	12.00
COP at +2 °C with heating water at 35 °C		3.40	3.32	3.40	3.32
Heating Capacity at -7 °C with heating water at 35 °C	kW	9.00	12.00	9.00	12.00
COP at -7 °C with heating water at 35 °C		2.70	2.50	2.70	2.50
Heating Capacity at -15 °C with heating water at 35 °C	kW	9.00	12.00	9.00	12.00
COP at -15 °C with heating water at 35 °C		2.40	2.15	2.40	2.15
Heating Capacity at +7 °C with heating water at 65 °C	kW	9.00	12.00	9.00	12.00
COP at +7 °C with heating water at 65 °C		2.25	2.20	2.25	2.20
Heating Capacity at +2 °C with heating water at 65 °C	kW	9.00	10.30	9.00	10.30
COP at +2 °C with heating water at 65 °C		1.88	1.83	1.88	1.83
Heating Capacity at -7 °C with heating water at 65 °C	kW	8.90	9.60	8.90	9.60
COP at -7 °C with heating water at 65 °C		1.62	1.61	1.64	1.61
Heating Capacity at -15 °C with heating water at 65 °C	kW	7.80	8.00	7.80	8.00
COP at -15 °C with heating water at 65 °C		1.32	1.30	1.32	1.30
Sound pressure level	dB(A)	49	50	49	50
Sound power level	dB	66	67	66	67
Dimensions	H x W x D	mm	1410 x 1283 x 320	1410 x 1283 x 320	1410 x 1283 x 320
Weight		kg	155	155	158
Water pipe connector			R 1 1/4	R 1 1/4	R 1 1/4
Pump	No. of Speed		3	3	3
	Input Power (Max.)	W	190	190	190
Heating water flow (ΔT=5 K, 35 °C)		l/min	25.8	34.4	25.8
Capacity of integrated electric heater		kW	3	6	3
Input Power		kW	1.98	2.73	1.98
Running and Starting current		A	9.5	12.8	9.5
Current 1		A	28.5	29.0	32.8
Current 2		A	26.0	26.0	13.0
Current 3		A		13.0	
Recommended Fuse		A			
Recommended power cable section		mm <sup>2</sup>			
Operation range	Outdoor ambient	°C	-20 to 35	-20 to 35	-20 to 35
Water outlet at -2/-7/-15		°C	25 - 65	25 - 65	25 - 65







COP classification is at 230 V only in accordance with EU directive 2003/32/EC. Sound pressure measured at 1 m from the outdoor unit and at 1.5 m height. Performance in agreement with EN14511.

\* Tentative specifications.



INTERNET CONTROL READY: Optional.

# Accessories

Tanks		Standard Sanitary		High Efficiency		Super High Efficiency		
Model		WH-TD20E3E5	WH-TD30E3E5-1	HR 200 <sup>1</sup>	HR 300 <sup>1</sup>	HRS 200 <sup>1</sup>	HRS 300 <sup>1</sup>	HRS 500 <sup>1</sup>
								
Water volume	L	200	300	200	300	200	300	500
Max. water temperature	°C	75	75	75	75	75	75	75
Dimension	Height / Diameter	mm 1,150 / 580	1,150 / 580	1,340 / 600	1,797 / 600	1,642 / 600	1,435 / 680	1,806 / 760
Weight	kg	49	65	108	140	135	170	254
Electric heater	kW	3	3	3	3	3	3	3
Power supply	V	230	230	230	230	230	230	230
Material inside tank		Inox	Inox	Enamelled	Enamelled	Enamelled	Enamelled	Enamelled
Exchange surface	m <sup>2</sup>	1.4	1.8	1.8	2.6	2.3	3.5	6.0
Energy loss at 65 °C (insulated tested under EN12897)	kWh/24h	1.9	2.3	1.8	2.2		2.2	2.7
3 Way valve included		Yes	Yes	Yes	Yes	Yes	Yes	Yes
20 m temperature sensor cable included		Yes	Yes	Yes	Yes	Yes	Yes	Yes
Heat up time	Valuation	★★★	★★★★	★★★★	★★★★	★★★★	★★★★	★★★★
Energy losses	Valuation	★★★★	★★★★	★★★★	★★★★	★★★★	★★★★	★★★★
Efficiency of the tank	Valuation	★★★	★★★★	★★★★	★★★★	★★★★	★★★★	★★★★
Warranty		10 years	10 years	7 years	7 years	7 years	7 years	7 years
Maintenance required		No	No	Yearly	Yearly	Yearly	Yearly	Yearly

Panasonic has developed unique, high efficiency water tanks with a large exchange surface and high levels of insulation to minimise energy losses. For example, the HRS200 tank is suitable for installation in non-heated areas.



1. Panasonic's term of warranty is based on the warranty conditions provided by the tank supplier being met. Please ensure the maintenance programme is carried out as instructed in the tank manufacturer's manual.



CZ-NS1P // CZ-NS3P // CZ-NS2P



CZ-TK1



PAW-TS1 / PAW-TS2



CZ-NE1P

Solar Kit Accessories	
CZ-NS1P	Solar connection PCB (for Bi-split type)
CZ-NS3P	Solar connection PCB (for Mono-Bloc 6 and 9 kW type)
CZ-NS2P	Solar connection PCB (for Mono-Bloc)
Sanitary Tank Accessories	
CZ-TK1	Temperature sensor kit for third party tank (with copper pocket and 6 m length sensor cable)
PAW-TS1	Sensor with 6 meter cable length
PAW-TS2	Sensor with 20 meter cable length

Deice Accessories	
CZ-NE1P	Base pan heater kit
Connectivity Solutions	
PAW-AW-KNX-1i	Interface to connect Aquarea to KNX
PAW-AW-ENO-1i	Interface to connect Aquarea to Enocan
PAW-AW-MBS-1	Interface to connect Aquarea to Modbus
PA-AW-WIFI-1	Interface to connect Aquarea to IntesisHome



PAW-HPM1



PAW-HPM2



PAW-HPMED



PAW-A2W-RTWIRED



PAW-A2W-RTWIRELESS

Aquarea Manager Kits		
Reference for Bi-Bloc and Mono-Bloc	Description	Material inside the kit
PAW-HPM12ZONE-U <sup>1</sup> PAW-HPM12ZONE-M <sup>2</sup>	Heat pump manager for control of 2 temperature zones, cascade system or bivalent system with room sensor and setpoint adaption	PAW-HPM1 // PAW-HPMINT-U <sup>1</sup> // PAW-HPMINT-M <sup>2</sup> // PAW-HPMB1 // PAW-HPMAH1 // PAW-HPMAH1 // PAW-HPMR4
PAW-HPM12ZONELCD-U <sup>1</sup> PAW-HPM12ZONELCD-M <sup>2</sup>	Heat pump manager for control of 2 temperature zones, cascade system or bivalent system with LCD Wireless Room Thermostat	PAW-HPM1 // PAW-HPMINT-U <sup>1</sup> // PAW-HPMINT-M <sup>2</sup> // PAW-HPMB1 // PAW-HPMAH1 // PAW-HPMAH1 // PAW-A2W-RTWIRELESS

Aquarea Manager Accessories	
PAW-HPM1	Aquarea Manager with LCD
PAW-HPM2	Aquarea Manager without LCD
PAW-HPMINT-U	Interface to connect Aquarea Manager to Heat pump Aquarea Bi-Bloc, with inverter control
PAW-HPMINT-M	Interface to connect Aquarea Manager to Heat pump Aquarea Mono-Bloc, with inverter control
PAW-HPMB1	Buffer tank sensor
PAW-HPMDHW	Buffer tank sensor with well
PAW-HPMSOL1	Buffer tank sensor solar (with higher temperature range)
PAW-HPMUH	Outdoor temperature sensor
PAW-HPMAH1	Water flow sensor for heating circuit
PAW-HPMR4	Room sensor
PAW-HPMED	Touch screen
PAW-HPMLCD	Room thermostat with LCD

Room Thermostats	
PAW-A2W-RTWIRED	Wired LCD room thermostat with weekly timer
PAW-A2W-RTWIRELESS	Wireless LCD room thermostat with weekly timer

Hydraulic Accessories	
PAW-1PMP2ZONE	2 zone kit with Aquarea Manager, manifold, one A-class pumps, 1 mixture valve and check valve+filter
PAW-2PMP2ZONE	2 zone kit with Aquarea Manager, hydraulic switch, manifold, 2 A-class pumps, one mixture valve and check valve+ filter
PAW-FILTER	2 check valves + filter

1 For Bi-Bloc.  
2 For Mono-Bloc.

## Examples of installations with Aquarea manager

**2 Zones Temperature Control with PAW-HPM12ZONE-U**

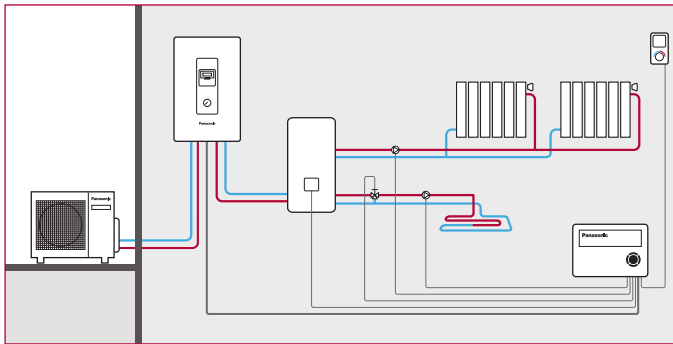

**3 Heat Pumps on cascade with PAW-HPM12ZONELCD-U**

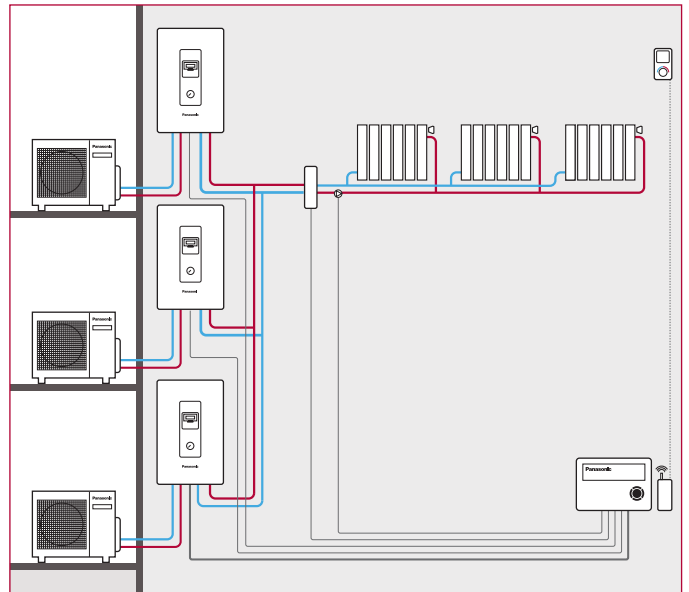

**2 Zones Temperature Control + DHW with PAW-HPM12ZONE-U**

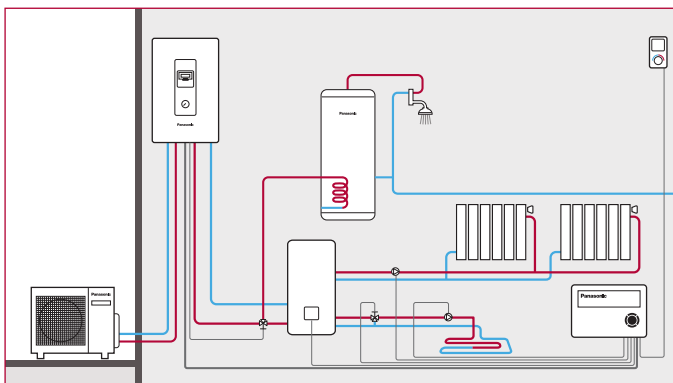

**Heat Pump + Boiler Management with DHW with PAW-HPM12ZONELCD-U**

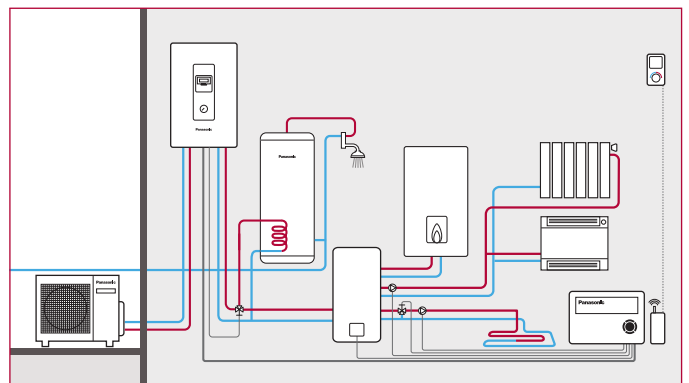

**2 Heat Pumps on cascade with PAW-HPM12ZONE-U**

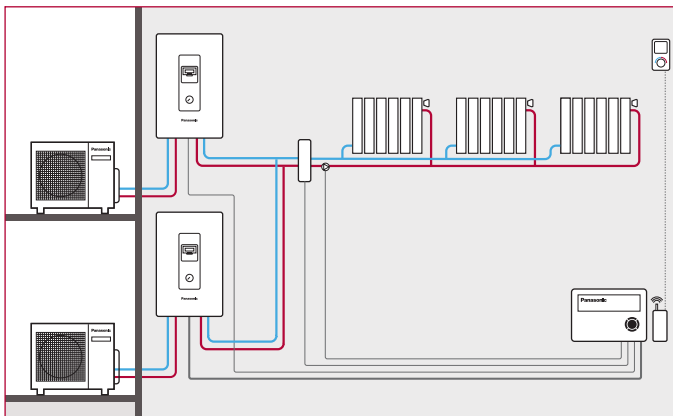

**2 Heat Pumps + Boiler with PAW-HPM12ZONE-U**

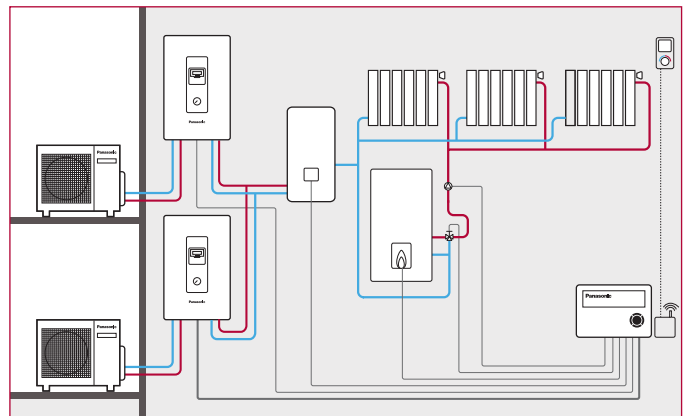

## NEW AQUAREA AIR RADIATORS

High efficiency climate control High Efficiency Radiators Aquarea Air terminals are extremely slim. With a depth of just under 13 cm they are at the cutting edge of the market. Blending easily into the home, Aquarea Air's elegant design, and product refinements are clear to see in every detail.

Its particular slimness has been obtained thanks to the innovative layout of the ventilation unit and the heat exchanger. The fan is tangential with asymmetric blades and the heat exchanger has large surface, enabling high airflows to be achieved with low pressure loss and low noise levels. Exceptional ventilation efficiency means the motor uses considerably less energy (low wattage). The fan speed is continuously modulated by the temperature controller with proportional integral logic, with undoubted advantages for regulating the temperature and humidity in summer mode.



Fan Coils for Heat Pump application	PAW-AAIR-200						PAW-AAIR-700						PAW-AAIR-900						
Total heating capacity	W	138	160	350	470	570	223	360	708	1032	1188	273	475	886	1420	1703			
Water flow	kg/h	23.7	27.5	60.2	80.8	98.0	38.4	61.9	121.8	177.5	204.3	47.0	81.7	152.4	244.2	292.9			
Water pressure drop	kPa	0.1	0.2	0.4	2.0	2.9	0.1	0.1	0.3	0.8	1.0	0.1	0.2	0.5	1.6	2.2			
Air flow	m³/h	28	37	55	113	162	44	84	155	252	320	54	110	248	367	461			
	Speed	Main Fan Off	Super	Min	Med	Max	Main Fan Off	Super	Min	Med	Max	Main Fan Off	Super	Min	Med	Max			
Maximum input power	W	2	5	7	9	13	3	9	14	18	22	3	11	16	20	24			
Sound pressure level	dB(A)	17.6	18.8	24.7	33.2	39.4	18.4	19.6	25.8	34.1	40.2	18.4	22.3	26.2	34.4	42.2			
Inlet water temperature	°C	35	35	35	35	35	35	35	35	35	35	35	35	35	35	35			
Outlet water temperature	°C	30	30	30	30	30	30	30	30	30	30	30	30	30	30	30			
Inlet air temperature	°C	19	19	19	19	19	19	19	19	19	19	19	19	19	19	19			
Outlet air temperature	°C	34.5	32.6	38.9	32.0	30.0	34.9	32.4	33.3	31.8	30.6	34.8	32.5	30.2	31.1	30.6			
Dimensions (H x W x D)	mm	735 x 576 x 129						935 x 576 x 129						1135 x 576 x 129					
3 ways valve included		Yes						Yes						Yes					
Touch screen thermostat		Yes						Yes						Yes					

During winter, the operating principle is based on micro fans of very low power consumption and minimum noise that send hot air, coming from the heat exchanger, to the inside of the front panel of the device and therefore heat it effectively. With this principle, the terminal also provides significant power while heating, without running the main fan. Comfort temperatures therefore maintained, without air movements and in silence. In summer mode, the airflow generated by the micro fans is stopped to avoid any dew formation on the terminal's front surface.

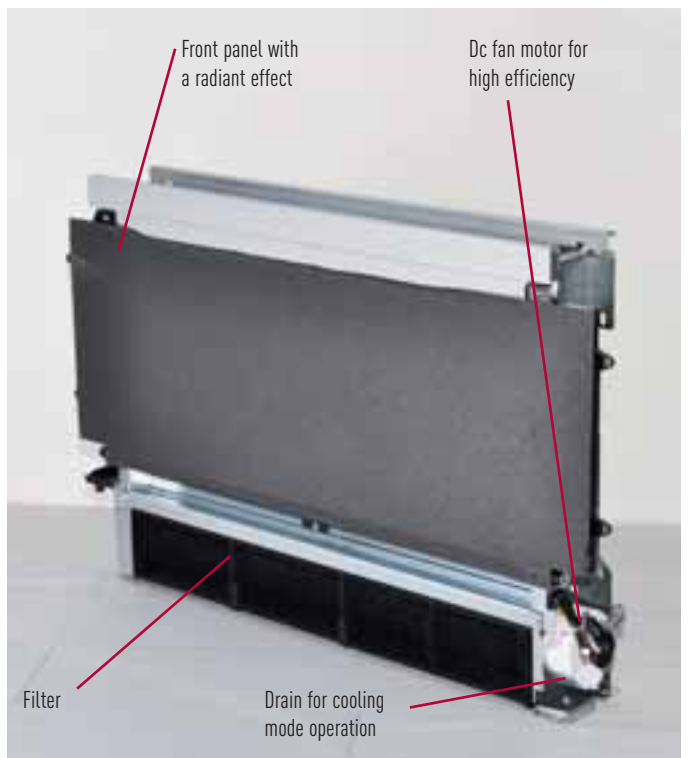
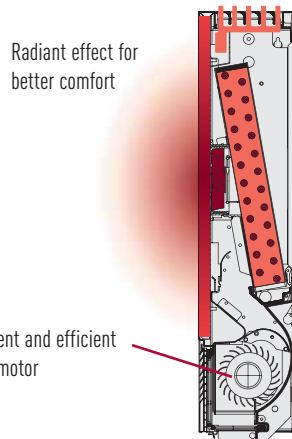

**32%**  
MORE EFFICIENT  
THAN STANDARD  
RADIATORS



PAW-AAIR-900

AQUAREA  
AIR



PAW-AAIR-700

PAW-AAIR-200

**New line up of Super low temperature radiators for Heat Pump application:**

Aquarea Air 200/700/900 with radiating effect

**Major Benefit**

- On the water installation
  - Only 1 water temperature on the water circuit (35 °C)
  - No expansive 2 zone kits
  - No overflow valve (as Aquarea Air has a 3-way valve)
  - Very easy to install
- On the efficiency
  - COP with water at 35 °C is 32% higher than efficiency with water at 45 °C! (case MDF06, at +7 °C)

**Main features**

- Front panel heating with radiant effect
- High heating capacity (without main fan running)
- 4 fan speeds and capacities
- Exclusive design
- Extremely compact (only 12.9 cm deep)
- Cooling and dehumidification functions possible (drain is needed)
- 3-way valve included (no overflow valve needed on the installation if more than 3 radiators installed)
- Touch screen thermostat



**Operating on heating mode with radiator using only radiant effect**

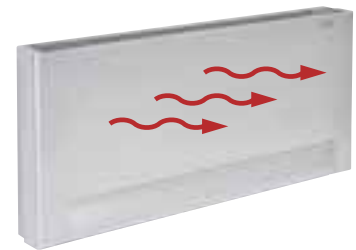

**Operating on heating mode with radiant effect and fan mode**

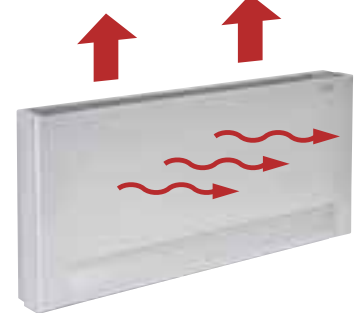

**Operating on cooling mode with fan**

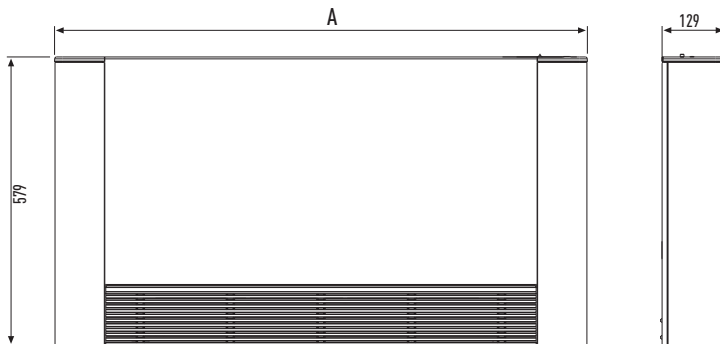
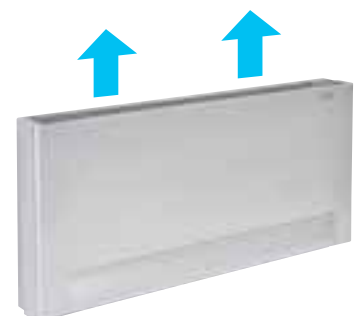

	200R	700R	900R
A	735	935	1135

# Heating Capacity table based on outlet temperature and outside temperature

**Aqueara. High Performance. Bi-Bloc Single Phase. Heating Only - SDF. Heating and Cooling - SDC. 3 and 5 kW**

**WH-SDF03E3E5**

Tamb	HC	IP	COP	HC	IP	COP	HC	IP	COP	HC	IP	COP	HC	IP	COP	HC	IP	COP
LWC	30	30	30	35	35	35	40	40	40	45	45	45	50	50	50	55	55	55
-15	3.20	1.39	2.30	3.20	1.39	2.30	3.00	1.64	1.83	3.00	1.64	1.83	2.75	1.92	1.43	2.75	1.92	1.43
-7/-8	3.20	1.19	2.69	3.20	1.19	2.69	3.20	1.48	2.16	3.20	1.48	2.16	3.20	1.86	1.72	3.20	1.86	1.72
2/1	3.20	0.90	3.56	3.20	0.90	3.56	3.20	1.16	2.76	3.20	1.16	2.76	3.20	1.49	2.15	3.20	1.49	2.15
7/6	3.20	0.64	5.00	3.20	0.64	5.00	3.20	0.89	3.60	3.20	0.89	3.60	3.20	1.20	2.67	3.20	1.20	2.67

**WH-SDF05E3E5**

Tamb	HC	IP	COP	HC	IP	COP	HC	IP	COP	HC	IP	COP	HC	IP	COP	HC	IP	COP
LWC	30	30	30	35	35	35	40	40	40	45	45	45	50	50	50	55	55	55
-15	4.20	1.94	2.16	4.20	1.94	2.16	3.4	1.98	1.72	3.40	1.98	1.72	3.00	2.12	1.42	3.00	2.12	1.42
-7/-8	4.20	1.62	2.59	4.20	1.62	2.59	3.8	1.82	2.09	3.80	1.82	2.09	3.55	2.08	1.71	3.55	2.08	1.71
2/1	4.20	1.35	3.11	4.20	1.35	3.11	4.2	1.65	2.55	4.20	1.65	2.55	4.10	2.07	1.98	4.10	2.07	1.98
7/6	5.00	1.08	4.63	5.00	1.08	4.63	5.00	1.48	3.38	5.00	1.48	3.38	5.00	1.89	2.65	5.00	1.89	2.65

**Aqueara. High Performance. Mono-Bloc Single Phase. Heating Only - MDF. Heating and Cooling - MDC. 6 and 9 kW**

**WH-MDF06E3E5**

Tamb	HC	IP	COP	HC	IP	COP	HC	IP	COP	HC	IP	COP	HC	IP	COP	HC	IP	COP
LWC	30	30	30	35	35	35	40	40	40	45	45	45	50	50	50	55	55	55
-15	6.15	2.50	2.46	5.90	2.66	2.22	5.65	2.82	2.00	5.40	2.98	1.81	5.20	3.15	1.65	5.00	3.32	1.51
-7	5.18	1.68	3.08	5.15	1.92	2.68	5.13	2.17	2.36	5.10	2.41	2.12	5.45	2.81	1.94	5.80	3.20	1.81
2	5.00	1.23	4.06	5.00	1.45	3.45	5.00	1.68	2.98	5.00	1.90	2.63	5.00	2.19	2.29	5.00	2.48	2.02
7	6.00	1.13	5.31	6.00	1.35	4.44	6.00	1.58	3.80	6.00	1.80	3.33	6.00	2.09	2.87	6.00	2.38	2.52
25	7.30	0.78	9.36	7.10	0.93	7.63	6.90	1.09	6.33	6.70	1.24	5.40	6.50	1.41	4.61	6.30	1.58	3.99

**WH-MDF09E3E5**

Tamb	HC	IP	COP	HC	IP	COP	HC	IP	COP	HC	IP	COP	HC	IP	COP	HC	IP	COP
LWC	30	30	30	35	35	35	40	40	40	45	45	45	50	50	50	55	55	55
-15	7.90	3.62	2.18	7.60	3.77	2.02	7.30	3.93	1.86	7.00	4.08	1.72	6.45	4.06	1.59	5.90	4.03	1.46
-7	7.80	3.38	2.31	7.70	3.63	2.12	7.60	3.88	1.96	7.50	4.13	1.82	7.55	4.59	1.65	7.60	5.05	1.50
2	7.00	2.01	3.48	7.00	2.30	3.04	7.00	2.60	2.69	7.00	2.89	2.42	7.00	3.37	2.08	7.00	3.85	1.82
7	9.00	1.87	4.81	9.00	2.17	4.15	9.00	2.48	3.63	9.00	2.78	3.20	8.95	3.31	2.70	8.90	3.84	2.32
25	9.00	0.99	9.09	9.00	1.31	6.87	9.00	1.63	5.52	9.00	1.95	4.62	9.00	2.20	4.09	9.00	2.45	3.67

Constant Pressure Head Difference ( $\Delta p-c$ ) SDC. 3 and 5 kW

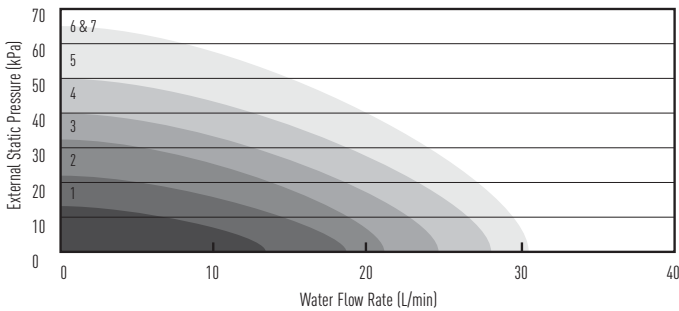

Variable Pressure Head Difference ( $\Delta p-v$ ) SDC. 3 and 5 kW

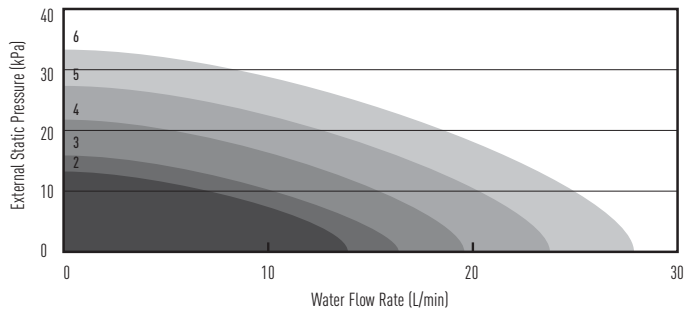

Constant Pressure Head Difference ( $\Delta p-c$ ) SDC. 6 and 9 kW

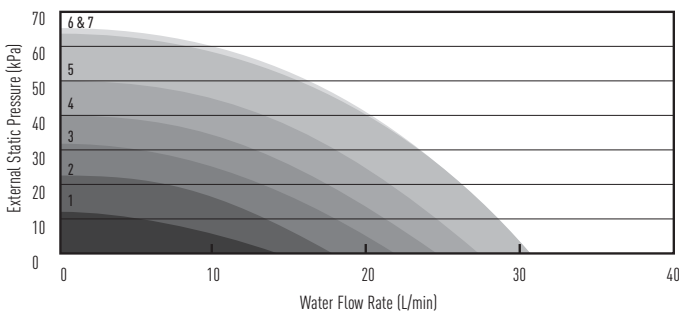

Variable Pressure Head Difference ( $\Delta p-v$ ) SDC. 6 and 9 kW

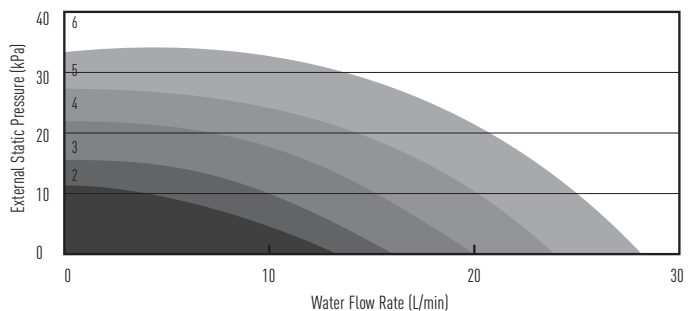





# Heating Capacity table based on outlet temperature and outside temperature

Aqueara. High Performance. Bi-Bloc Single Phase / Three Phase. Heating and Cooling - SDC												
Models	WH-SDC09			WH-SDC12			WH-SDC14			WH-SDC16		
Tamb	HC	IP	COP	HC	IP	COP	HC	IP	COP	HC	IP	COP
16	5.90	1.01	5.84	7.65	1.30	5.88	8.85	1.50	5.90	9.62	1.63	5.90
25	7.45	1.59	4.69	9.20	2.30	4.00	10.00	2.68	3.73	10.51	2.85	3.69
35	7.00	2.25	3.11	10.00	3.55	2.82	11.50	4.40	2.61	12.20	4.80	2.54
43	5.80	2.59	2.24	7.60	3.95	1.92	9.05	5.01	1.81	10.08	5.47	1.84

Aqueara. High Performance. Mono-Bloc Single Phase / Three Phase. Heating Only - MDF																		
WH-MDF12C6E5																		
Tamb	HC	IP	COP	HC	IP	COP	HC	IP	COP	HC	IP	COP	HC	IP	COP	HC	IP	COP
LWC	30	30	30	35	35	35	40	40	40	45	45	45	50	50	50	55	55	55
-15	9.30	3.50	2.66	8.90	3.66	2.43	8.50	3.83	2.22	8.10	3.99	2.03	7.50	4.09	1.83	7.00	4.20	1.67
-7	10.40	3.41	3.05	10.00	3.70	2.70	9.60	3.90	2.46	9.20	4.10	2.24	8.70	4.20	2.07	8.20	4.31	1.90
2	11.80	3.14	3.76	11.40	3.34	3.41	11.00	3.57	3.08	10.60	3.78	2.80	9.80	3.98	2.46	9.10	4.18	2.18
7	12.00	2.14	5.61	12.00	2.57	4.67	12.00	3.00	4.00	12.00	3.43	3.50	12.00	3.82	3.14	12.00	4.20	2.86
25	12.00	1.42	8.45	12.00	1.70	7.06	11.80	1.98	5.96	11.70	2.27	5.15	11.50	2.53	4.55	11.40	2.78	4.10

WH-MDF14C6E5																		
Tamb	HC	IP	COP	HC	IP	COP	HC	IP	COP	HC	IP	COP	HC	IP	COP	HC	IP	COP
LWC	30	30	30	35	35	35	40	40	40	45	45	45	50	50	50	55	55	55
-15	9.90	3.91	2.53	9.50	4.05	2.35	9.00	4.19	2.15	8.60	4.33	1.99	7.90	4.45	1.78	7.30	4.56	1.60
-7	11.10	3.73	2.98	10.70	4.00	2.68	10.20	4.20	2.43	9.80	4.40	2.23	9.10	4.57	1.99	8.50	4.74	1.79
2	12.90	3.51	3.68	12.40	3.73	3.32	11.90	3.95	3.01	11.40	4.17	2.73	10.40	4.29	2.42	9.50	4.40	2.16
7	14.00	2.60	5.38	14.00	3.11	4.50	14.00	3.63	3.86	14.00	4.14	3.38	13.60	4.61	2.95	13.30	5.08	2.62
25	14.00	1.75	8.00	14.00	2.10	6.67	14.00	2.45	5.71	14.00	2.80	5.00	14.00	3.05	4.59	14.00	3.44	4.07

WH-MDF16C6E5																		
Tamb	HC	IP	COP	HC	IP	COP	HC	IP	COP	HC	IP	COP	HC	IP	COP	HC	IP	COP
LWC	30	30	30	35	35	35	40	40	40	45	45	45	50	50	50	55	55	55
-15	10.60	4.13	2.57	10.30	4.42	2.33	10.00	4.71	2.12	9.70	5.00	1.94	8.80	4.98	1.77	7.90	4.95	1.60
-7	11.90	4.07	2.92	11.40	4.30	2.65	10.80	4.50	2.40	10.30	4.70	2.19	9.60	4.85	1.98	9.00	4.99	1.80
2	13.50	3.78	3.57	13.00	4.00	3.25	12.40	4.22	2.94	11.90	4.44	2.68	10.80	4.50	2.40	9.80	4.55	2.15
7	16.00	3.25	4.92	16.00	3.78	4.23	16.00	4.31	3.71	16.00	4.84	3.31	15.20	5.15	2.95	14.50	5.45	2.66
25	16.00	2.35	6.81	16.00	2.73	5.86	16.00	3.11	5.14	16.00	3.49	4.58	16.00	3.71	4.31	15.90	3.93	4.05

Tamb: Ambient Temperature (°C). LWC: Leaving Water Condenser Temperature (°C). HC: Heating Capacity (kW). IP: Power Input (kW)  
 This data is measured by Panasonic in accordance with EN14511-2 standard. This data is for reference purpose only, and does not guarantee the performance.

## Hydraulic Pump Performance

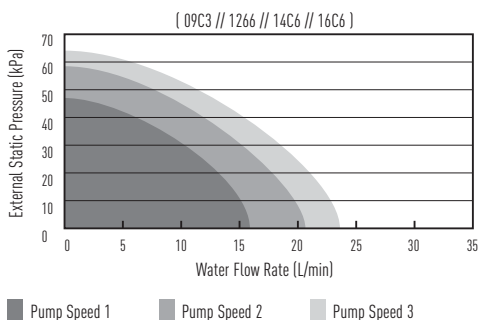

## Aquarea. High Performance. Mono-Bloc Single Phase / Three Phase. Heating Only - MDF (Cont.)

WH-MDF09C3E8																			
Tamb	HC	IP	COP	HC	IP	COP	HC	IP	COP	HC	IP	COP	HC	IP	COP	HC	IP	COP	
LWC	30	30	30	35	35	35	40	40	40	45	45	45	50	50	50	55	55	55	
-15	8.65	3.10	2.79	8.30	3.25	2.55	7.95	3.45	2.30	7.95	3.45	2.30	7.15	3.75	1.91	7.15	3.75	1.91	
-7	9.35	2.95	3.17	9.00	3.20	2.81	8.85	3.50	2.53	8.85	3.50	2.53	8.30	3.85	2.16	8.30	3.85	2.16	
2	9.31	2.39	3.90	9.00	2.55	3.53	9.00	2.82	3.19	9.00	2.82	3.19	8.90	3.53	2.52	8.90	3.53	2.52	
7	9.00	1.58	5.70	9.00	1.90	4.74	9.00	2.20	4.09	9.00	2.20	4.09	9.00	2.80	3.21	9.00	2.80	3.21	
25	9.00	1.09	8.26	9.00	1.28	7.03	8.73	1.48	5.90	8.73	1.48	5.90	8.28	1.86	4.45	8.28	1.86	4.45	

## WH-MDF12C9E8

Tamb	HC	IP	COP	HC	IP	COP	HC	IP	COP	HC	IP	COP	HC	IP	COP	HC	IP	COP
LWC	30	30	30	35	35	35	40	40	40	45	45	45	50	50	50	55	55	55
-15	9.30	3.50	2.66	8.90	3.66	2.43	8.50	3.83	2.22	8.10	3.99	2.03	7.50	4.09	1.83	7.00	4.20	1.67
-7	10.40	3.41	3.05	10.00	3.70	2.70	9.60	3.90	2.46	9.20	4.10	2.24	8.70	4.20	2.07	8.20	4.31	1.90
2	11.80	3.14	3.76	11.40	3.34	3.41	11.00	3.57	3.08	10.60	3.78	2.80	9.80	3.98	2.46	9.10	4.18	2.18
7	12.00	2.14	5.61	12.00	2.57	4.67	12.00	3.00	4.00	12.00	3.43	3.50	12.00	3.82	3.14	12.00	4.20	2.86
25	12.00	1.42	8.45	12.00	1.70	7.06	11.80	1.98	5.96	11.70	2.27	5.15	11.50	2.53	4.55	11.40	2.78	4.10

## WH-MDF14C9E8

Tamb	HC	IP	COP	HC	IP	COP	HC	IP	COP	HC	IP	COP	HC	IP	COP	HC	IP	COP
LWC	30	30	30	35	35	35	40	40	40	45	45	45	50	50	50	55	55	55
-15	9.90	3.91	2.53	9.50	4.05	2.35	9.00	4.19	2.15	8.60	4.33	1.99	7.90	4.45	1.78	7.30	4.56	1.60
-7	11.10	3.73	2.98	10.70	4.00	2.68	10.20	4.20	2.43	9.80	4.40	2.23	9.10	4.57	1.99	8.50	4.74	1.79
2	12.90	3.51	3.68	12.40	3.73	3.32	11.90	3.95	3.01	11.40	4.17	2.73	10.40	4.29	2.42	9.50	4.40	2.16
7	14.00	2.60	5.38	14.00	3.11	4.50	14.00	3.63	3.86	14.00	4.14	3.38	13.60	4.61	2.95	13.30	5.08	2.62
25	14.00	1.75	8.00	14.00	2.10	6.67	14.00	2.45	5.71	14.00	2.80	5.00	14.00	3.05	4.59	14.00	3.44	4.07

## WH-MDF16C9E8

Tamb	HC	IP	COP	HC	IP	COP	HC	IP	COP	HC	IP	COP	HC	IP	COP	HC	IP	COP
LWC	30	30	30	35	35	35	40	40	40	45	45	45	50	50	50	55	55	55
-15	10.60	4.13	2.57	10.30	4.42	2.33	10.00	4.71	2.12	9.70	5.00	1.94	8.80	4.98	1.77	7.90	4.95	1.60
-7	11.90	4.07	2.92	11.40	4.30	2.65	10.80	4.50	2.40	10.30	4.70	2.19	9.60	4.85	1.98	9.00	4.99	1.80
2	13.50	3.78	3.57	13.00	4.00	3.25	12.40	4.22	2.94	11.90	4.44	2.68	10.80	4.50	2.40	9.80	4.55	2.15
7	16.00	3.25	4.92	16.00	3.78	4.23	16.00	4.31	3.71	16.00	4.84	3.31	15.20	5.15	2.95	14.50	5.45	2.66
25	16.00	2.35	6.81	16.00	2.73	5.86	16.00	3.11	5.14	16.00	3.49	4.58	16.00	3.71	4.31	15.90	3.93	4.05

## Aquarea. High Performance. Mono-Bloc Single Phase / Three Phase. Heating and Cooling - MDC

Models	WH-MDC09			WH-MDC12			WH-MDC14			WH-MDC16		
Tamb	HC	IP	COP	HC	IP	COP	HC	IP	COP	HC	IP	COP
16	5.90	1.01	5.84	7.65	1.30	5.88	8.85	1.50	5.90	9.62	1.63	5.90
25	7.45	1.59	4.69	9.20	2.30	4.00	10.00	2.68	3.73	10.51	2.85	3.69
35	7.00	2.25	3.11	10.00	3.60	2.78	11.50	4.40	2.61	12.20	4.80	2.54
43	5.80	2.59	2.24	7.60	3.95	1.92	9.05	5.01	1.81	10.08	5.47	1.84

Tamb: Ambient Temperature (°C). LWC: Leaving Water Condenser Temperature (°C). HC: Heating Capacity (kW). IP: Power Input (kW)

This data is measured by Panasonic in accordance with EN14511-2 standard. This data is for reference purpose only, and does not guarantee the performance.

# Heating Capacity table based on outlet temperature and outside temperature

**Aquarea T-CAP. Mono-Bloc Single Phase / Three Phase. Heating Only - MXF**

**WH-MXF09D3E5**

Tamb	HC	IP	COP	HC	IP	COP	HC	IP	COP	HC	IP	COP	HC	IP	COP	HC	IP	COP
LWC	30	30	30	35	35	35	40	40	40	45	45	45	50	50	50	55	55	55
-15	9.00	3.28	2.74	9.00	3.55	2.54	9.00	3.95	2.28	9.00	4.34	2.07	9.00	4.77	1.89	9.00	5.20	1.73
-7	9.00	2.75	3.27	9.00	3.20	2.81	9.00	3.66	2.46	9.00	4.11	2.19	9.00	4.31	2.09	9.00	4.50	2.00
2	9.00	2.40	3.75	9.00	2.55	3.53	9.00	2.82	3.19	9.00	3.09	2.91	9.00	3.60	2.50	9.00	4.11	2.19
7	9.00	1.68	5.36	9.00	1.90	4.74	9.00	2.20	4.09	9.00	2.50	3.60	9.00	2.88	3.13	9.00	3.10	2.90
25	13.60	1.54	8.83	13.60	1.75	7.77	13.20	1.97	6.70	12.80	2.18	5.87	12.00	2.45	4.90	11.20	2.71	4.13

**WH-MXF12D6E5**

Tamb	HC	IP	COP	HC	IP	COP	HC	IP	COP	HC	IP	COP	HC	IP	COP	HC	IP	COP
LWC	30	30	30	35	35	35	40	40	40	45	45	45	50	50	50	55	55	55
-15	12.00	4.79	2.51	12.00	5.00	2.40	11.50	5.21	2.21	11.00	5.42	2.03	10.70	5.86	1.83	10.50	6.30	1.67
-7	12.00	3.89	3.08	12.00	4.45	2.70	12.00	5.02	2.39	12.00	5.58	2.15	12.00	5.94	2.02	12.00	6.30	1.90
2	12.00	3.23	3.72	12.00	3.53	3.40	12.00	3.91	3.07	12.00	4.29	2.80	12.00	4.90	2.45	12.00	5.51	2.18
7	12.00	2.22	5.41	12.00	2.57	4.67	12.00	3.00	4.00	12.00	3.43	3.50	12.00	3.82	3.14	12.00	4.20	2.86
25	13.60	1.59	8.55	13.60	1.80	7.56	13.40	2.14	6.26	13.20	2.47	5.34	12.60	2.70	4.67	12.00	2.93	4.10

**WH-MXF09D3E8**

Tamb	HC	IP	COP	HC	IP	COP	HC	IP	COP	HC	IP	COP	HC	IP	COP	HC	IP	COP
LWC	30	30	30	35	35	35	40	40	40	45	45	45	50	50	50	55	55	55
-15	9.00	3.28	2.74	9.00	3.55	2.54	9.00	3.95	2.28	9.00	4.34	2.07	9.00	4.77	1.89	9.00	5.20	1.73
-7	9.00	2.75	3.27	9.00	3.20	2.81	9.00	3.66	2.46	9.00	4.11	2.19	9.00	4.31	2.09	9.00	4.50	2.00
2	9.00	2.40	3.75	9.00	2.55	3.53	9.00	2.82	3.19	9.00	3.09	2.91	9.00	3.60	2.50	9.00	4.11	2.19
7	9.00	1.68	5.36	9.00	1.90	4.74	9.00	2.20	4.09	9.00	2.50	3.60	9.00	2.88	3.13	9.00	3.10	2.90
25	13.60	1.54	8.83	13.60	1.75	7.77	13.20	1.97	6.70	12.80	2.18	5.87	12.00	2.45	4.90	11.20	2.71	4.13

**WH-MXF12D9E8**

Tamb	HC	IP	COP	HC	IP	COP	HC	IP	COP	HC	IP	COP	HC	IP	COP	HC	IP	COP
LWC	30	30	30	35	35	35	40	40	40	45	45	45	50	50	50	55	55	55
-15	12.00	4.79	2.51	12.00	5.00	2.40	12.00	5.45	2.20	12.00	5.90	2.03	11.50	6.28	1.83	11.10	6.66	1.67
-7	12.00	3.89	3.08	12.00	4.45	2.70	12.00	5.02	2.39	12.00	5.58	2.15	12.00	5.94	2.02	12.00	6.30	1.90
2	12.00	3.23	3.72	12.00	3.53	3.40	12.00	3.91	3.07	12.00	4.29	2.80	12.00	4.90	2.45	12.00	5.51	2.18
7	12.00	2.22	5.41	12.00	2.57	4.67	12.00	3.00	4.00	12.00	3.43	3.50	12.00	3.82	3.14	12.00	4.20	2.86
25	13.60	1.59	8.55	13.60	1.80	7.56	13.40	2.14	6.26	13.20	2.47	5.34	12.60	2.70	4.67	12.00	2.93	4.10

**Aquarea T-CAP. Mono-Bloc Single Phase / Three Phase. Heating and Cooling - MXC**

MODELS	WH-MXC09			WH-MXC12		
	HC	IP	COP	HC	IP	COP
16	7.00	1.40	5.00	7.50	1.45	5.17
25	7.65	1.95	3.92	8.90	2.20	4.05
35	7.00	2.25	3.11	10.00	3.60	2.78
43	6.25	2.70	2.31	8.00	3.05	2.62

Tamb: Ambient Temperature (°C). LWC: Leaving Water Condenser Temperature (°C). HC: Heating Capacity (kW). IP: Power Input (kW)  
 This data is measured by Panasonic in accordance with EN14511-2 standard. This data is for reference purpose only, and does not guarantee the performance.

## Hydraulic Pump Performance

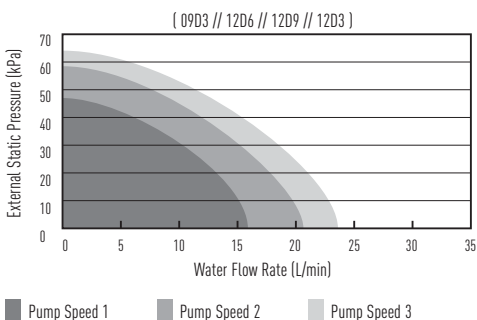

Aquarea T-CAP. Bi-Bloc Single Phase / Three Phase. Heating and Cooling - SXC

Models	WH-SXC09			WH-SXC12		
	HC	IP	COP	HC	IP	COP
Tamb						
16	7.00	1.40	5.00	7.50	1.45	5.17
25	7.65	1.95	3.92	8.90	2.20	4.05
35	7.00	2.25	3.11	10.00	3.60	2.78
43	6.25	2.70	2.31	8.00	3.05	2.62

Aquarea T-CAP. Bi-Bloc Single Phase / Three Phase. Heating Only - SXF

WH-SXF09D3E5																					
Tamb	HC	IP	COP	HC	IP	COP	HC	IP	COP	HC	IP	COP	HC	IP	COP	HC	IP	COP	HC	IP	COP
LWC	30	30	30	35	35	35	40	40	40	45	45	45	50	50	50	55	55	55	55	55	55
-15	9.00	3.28	2.74	9.00	3.55	2.54	9.00	3.95	2.28	9.00	4.34	2.07	9.00	4.77	1.89	9.00	5.20	1.73	9.00	5.20	1.73
-7	9.00	2.75	3.27	9.00	3.20	2.81	9.00	3.66	2.46	9.00	4.11	2.19	9.00	4.31	2.09	9.00	4.50	2.00	9.00	4.50	2.00
2	9.00	2.40	3.75	9.00	2.55	3.53	9.00	2.82	3.19	9.00	3.09	2.91	9.00	3.60	2.50	9.00	4.11	2.19	9.00	4.11	2.19
7	9.00	1.68	5.36	9.00	1.90	4.74	9.00	2.20	4.09	9.00	2.50	3.60	9.00	2.80	3.21	9.00	3.10	2.90	9.00	3.10	2.90
25	13.60	1.54	8.83	13.60	1.75	7.77	13.20	1.97	6.70	12.80	2.18	5.87	12.00	2.45	4.90	11.20	2.71	4.13	9.00	2.71	4.13

WH-SXF12D6E5																					
Tamb	HC	IP	COP	HC	IP	COP	HC	IP	COP	HC	IP	COP	HC	IP	COP	HC	IP	COP	HC	IP	COP
LWC	30	30	30	35	35	35	40	40	40	45	45	45	50	50	50	55	55	55	55	55	55
-15	12.00	4.79	2.51	12.00	5.00	2.40	11.50	5.21	2.21	11.00	5.42	2.03	10.70	5.86	1.83	10.50	6.30	1.67	12.00	6.30	1.67
-7	12.00	3.89	3.08	12.00	4.45	2.70	12.00	5.02	2.39	12.00	5.58	2.15	12.00	5.94	2.02	12.00	6.30	1.90	12.00	6.30	1.90
2	12.00	3.23	3.72	12.00	3.53	3.40	12.00	3.91	3.07	12.00	4.29	2.80	12.00	4.90	2.45	12.00	5.51	2.18	12.00	5.51	2.18
7	12.00	2.22	5.41	12.00	2.57	4.67	12.00	3.00	4.00	12.00	3.43	3.50	12.00	3.82	3.14	12.00	4.20	2.86	12.00	4.20	2.86
25	13.60	1.59	8.55	13.60	1.80	7.56	13.40	2.14	6.26	13.20	2.47	5.34	12.60	2.70	4.67	12.00	2.93	4.10	12.00	2.93	4.10

WH-SXF09D3E8																					
Tamb	HC	IP	COP	HC	IP	COP	HC	IP	COP	HC	IP	COP	HC	IP	COP	HC	IP	COP	HC	IP	COP
LWC	30	30	30	35	35	35	40	40	40	45	45	45	50	50	50	55	55	55	55	55	55
-15	9.00	3.28	2.74	9.00	3.55	2.54	9.00	3.95	2.28	9.00	4.34	2.07	9.00	4.77	1.89	9.00	5.20	1.73	9.00	5.20	1.73
-7	9.00	2.75	3.27	9.00	3.20	2.81	9.00	3.66	2.46	9.00	4.11	2.19	9.00	4.31	2.09	9.00	4.50	2.00	9.00	4.50	2.00
2	9.00	2.40	3.75	9.00	2.55	3.53	9.00	2.82	3.19	9.00	3.09	2.91	9.00	3.60	2.50	9.00	4.11	2.19	9.00	4.11	2.19
7	9.00	1.68	5.36	9.00	1.90	4.74	9.00	2.20	4.09	9.00	2.50	3.60	9.00	2.80	3.21	9.00	3.10	2.90	9.00	3.10	2.90
25	13.60	1.54	8.83	13.60	1.75	7.77	13.20	1.97	6.70	12.80	2.18	5.87	12.00	2.45	4.90	11.20	2.71	4.13	9.00	2.71	4.13

WH-SXF12D9E8																					
Tamb	HC	IP	COP	HC	IP	COP	HC	IP	COP	HC	IP	COP	HC	IP	COP	HC	IP	COP	HC	IP	COP
LWC	30	30	30	35	35	35	40	40	40	45	45	45	50	50	50	55	55	55	55	55	55
-15	12.00	4.79	2.51	12.00	5.00	2.40	12.00	5.45	2.20	12.00	5.90	2.03	11.80	6.28	1.88	11.60	6.66	1.74	12.00	6.66	1.74
-7	12.00	3.89	3.08	12.00	4.45	2.70	12.00	5.02	2.39	12.00	5.58	2.15	12.00	5.94	2.02	12.00	6.30	1.90	12.00	6.30	1.90
2	12.00	3.23	3.72	12.00	3.53	3.40	12.00	3.91	3.07	12.00	4.29	2.80	12.00	4.90	2.45	12.00	5.51	2.18	12.00	5.51	2.18
7	12.00	2.22	5.41	12.00	2.57	4.67	12.00	3.00	4.00	12.00	3.43	3.50	12.00	3.82	3.14	12.00	4.20	2.86	12.00	4.20	2.86
25	13.60	1.59	8.55	13.60	1.80	7.56	13.40	2.14	6.26	13.20	2.47	5.34	12.60	2.70	4.67	12.00	2.93	4.10	12.00	2.93	4.10

Tamb: Ambient Temperature (°C). LWC: Leaving Water Condenser Temperature (°C). HC: Heating Capacity (kW). IP: Power Input (kW)  
 This data is measured by Panasonic in accordance with EN14511-2 standard. This data is for reference purpose only, and does not guarantee the performance.

Constant Pressure Head Difference ( $\Delta p_c$ )

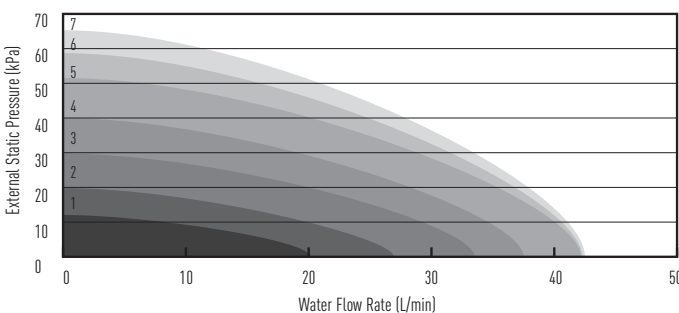

Variable Pressure Head Difference ( $\Delta p_v$ )

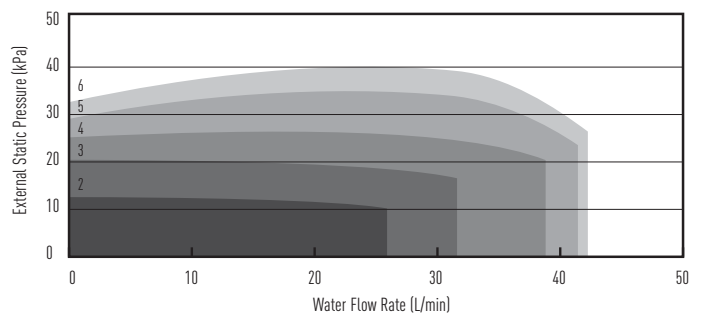

# Heating Capacity table based on outlet temperature and outside temperature

Aquarea HT. Bi-Bloc Single Phase / Three Phase. Heating Only - SHF												
WH-SHF09D3E5												
Tamb	HC	IP	COP	HC	IP	COP	HC	IP	COP	HC	IP	COP
LWC	35	35	35	45	45	45	55	55	55	65	65	65
-15	9	3.75	2.40	8.80	4.30	2.05	8.50	4.95	1.72	7.80	5.90	1.32
-7	9	3.33	2.70	8.90	3.87	2.30	8.90	4.50	1.98	8.90	5.50	1.62
2	9	2.65	3.40	9.00	3.25	2.77	9.00	3.92	2.30	9.00	4.80	1.88
7	9	1.98	4.55	9.00	2.50	3.60	9.00	3.16	2.85	9.00	4.00	2.25

WH-SHF12D6E5												
Tamb	HC	IP	COP	HC	IP	COP	HC	IP	COP	HC	IP	COP
LWC	35	35	35	45	45	45	55	55	55	65	65	65
-15	12	5.57	2.15	10.80	5.53	1.95	9.70	5.80	1.67	8.00	6.15	1.30
-7	12	4.80	2.50	11.20	5.10	2.20	10.10	5.32	1.90	9.60	5.95	1.61
2	12	3.72	3.23	11.30	4.18	2.70	10.80	4.90	2.20	10.30	5.63	1.83
7	12	2.73	4.40	12.00	3.48	3.45	12.00	4.32	2.78	12.00	5.45	2.20

WH-SHF09D3E8												
Tamb	HC	IP	COP	HC	IP	COP	HC	IP	COP	HC	IP	COP
LWC	35	35	35	45	45	45	55	55	55	65	65	65
-15	9	3.75	2.40	8.80	4.30	2.05	8.50	4.95	1.72	7.80	5.90	1.32
-7	9	3.33	2.70	8.90	3.87	2.30	8.90	4.50	1.98	8.90	5.50	1.62
2	9	2.65	3.40	9.00	3.25	2.77	9.00	3.92	2.30	9.00	4.80	1.88
7	9	1.98	4.55	9.00	2.50	3.60	9.00	3.16	2.85	9.00	4.00	2.25

WH-SHF12D9E8												
Tamb	HC	IP	COP	HC	IP	COP	HC	IP	COP	HC	IP	COP
LWC	35	35	35	45	45	45	55	55	55	65	65	65
-15	12	5.57	2.15	10.80	5.53	1.95	9.70	5.80	1.67	8.00	6.15	1.30
-7	12	4.80	2.50	11.20	5.10	2.20	10.10	5.32	1.90	9.60	5.95	1.61
2	12	3.72	3.23	11.30	4.18	2.70	10.80	4.90	2.20	10.30	5.63	1.83
7	12	2.73	4.40	12.00	3.48	3.45	12.00	4.32	2.78	12.00	5.45	2.20

Tamb: Ambient Temperature (°C). LWC: Leaving Water Condenser Temperature (°C). HC: Heating Capacity (kW). IP: Power Input (kW)  
 This data is measured by Panasonic in accordance with EN14511-2 standard. This data is for reference purpose only, and does not guarantee the performance.

## Hydraulic Pump Performance

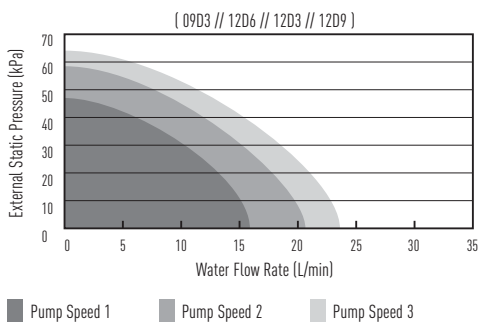

## Aquarea Ht. Mono-Bloc Single Phase / Three Phase. Heating Only - MHF

## WH-MHF09D3E5

Tamb	HC	IP	COP	HC	IP	COP	HC	IP	COP	HC	IP	COP
LWC	35	35	35	45	45	45	55	55	55	65	65	65
-15	9	3.75	2.40	8.80	4.30	2.05	8.50	4.95	1.72	7.80	5.90	1.32
-7	9	3.33	2.70	8.90	3.87	2.30	8.90	4.50	1.98	8.90	5.50	1.62
2	9	2.65	3.40	9.00	3.25	2.77	9.00	3.92	2.30	9.00	4.80	1.88
7	9	1.98	4.55	9.00	2.50	3.60	9.00	3.16	2.85	9.00	4.00	2.25

## WH-MHF12D6E5

Tamb	HC	IP	COP	HC	IP	COP	HC	IP	COP	HC	IP	COP
LWC	35	35	35	45	45	45	55	55	55	65	65	65
-15	12	5.57	2.15	10.80	5.53	1.95	9.70	5.80	1.67	8.00	6.15	1.30
-7	12	4.80	2.50	11.20	5.10	2.20	10.10	5.32	1.90	9.60	5.95	1.61
2	12	3.72	3.23	11.30	4.18	2.70	10.80	4.90	2.20	10.30	5.63	1.83
7	12	2.73	4.40	12.00	3.48	3.45	12.00	4.32	2.78	12.00	5.45	2.20

## WH-MHF09D3E8

Tamb	HC	IP	COP	HC	IP	COP	HC	IP	COP	HC	IP	COP
LWC	35	35	35	45	45	45	55	55	55	65	65	65
-15	9	3.75	2.40	8.80	4.30	2.05	8.50	4.95	1.72	7.80	5.90	1.32
-7	9	3.33	2.70	8.90	3.87	2.30	8.90	4.50	1.98	8.90	5.50	1.62
2	9	2.65	3.40	9.00	3.25	2.77	9.00	3.92	2.30	9.00	4.80	1.88
7	9	1.98	4.55	9.00	2.50	3.60	9.00	3.16	2.85	9.00	4.00	2.25

## WH-MHF12D9E8

Tamb	HC	IP	COP	HC	IP	COP	HC	IP	COP	HC	IP	COP
LWC	35	35	35	45	45	45	55	55	55	65	65	65
-15	12	5.57	2.15	10.80	5.53	1.95	9.70	5.80	1.67	8.00	6.15	1.30
-7	12	4.80	2.50	11.20	5.10	2.20	10.10	5.32	1.90	9.60	5.95	1.61
2	12	3.72	3.23	11.30	4.18	2.70	10.80	4.90	2.20	10.30	5.63	1.83
7	12	2.73	4.40	12.00	3.48	3.45	12.00	4.32	2.78	12.00	5.45	2.20

Tamb: Ambient Temperature (°C). LWC: Leaving Water Condenser Temperature (°C). HC: Heating Capacity (kW). IP: Power Input (kW)

This data is measured by Panasonic in accordance with EN14511-2 standard. This data is for reference purpose only, and does not guarantee the performance.

# Dimensions

## Hydraulic Module for all models

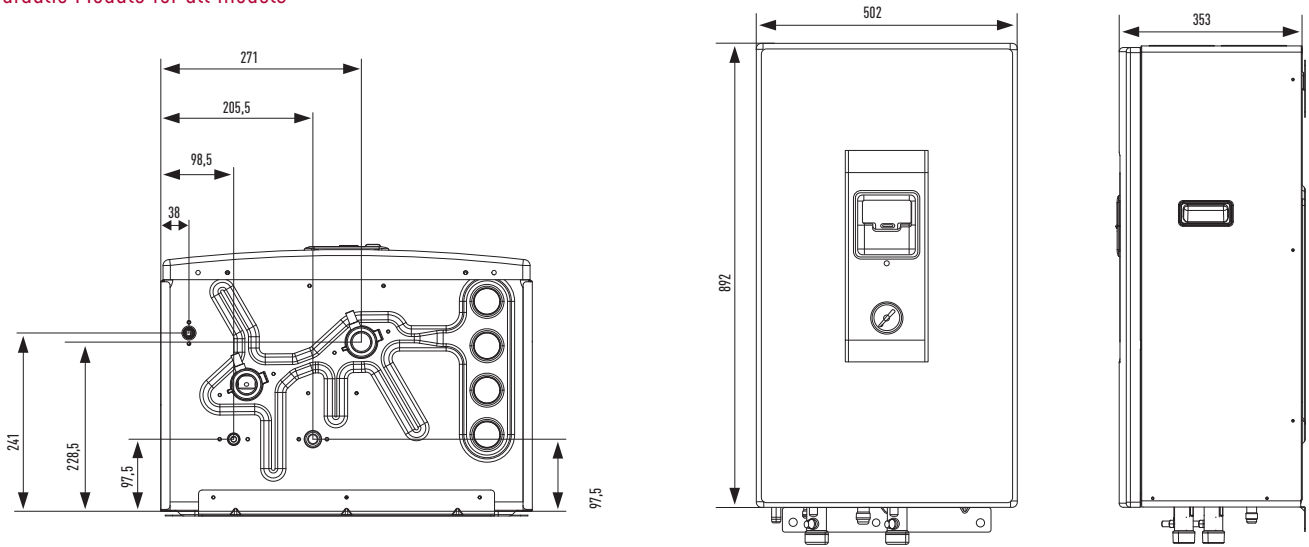

## Bi-Bloc 3 and 5 kW

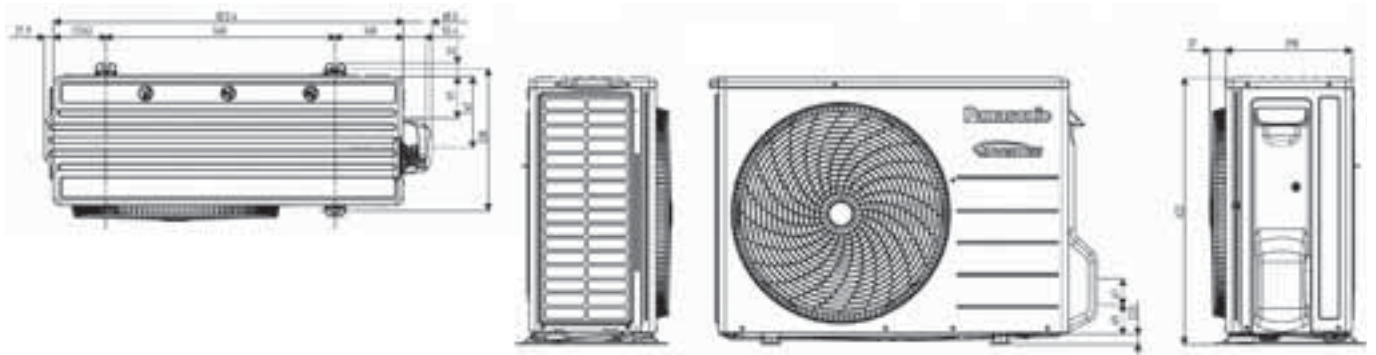

## Mono-Bloc 6 and 9 kW

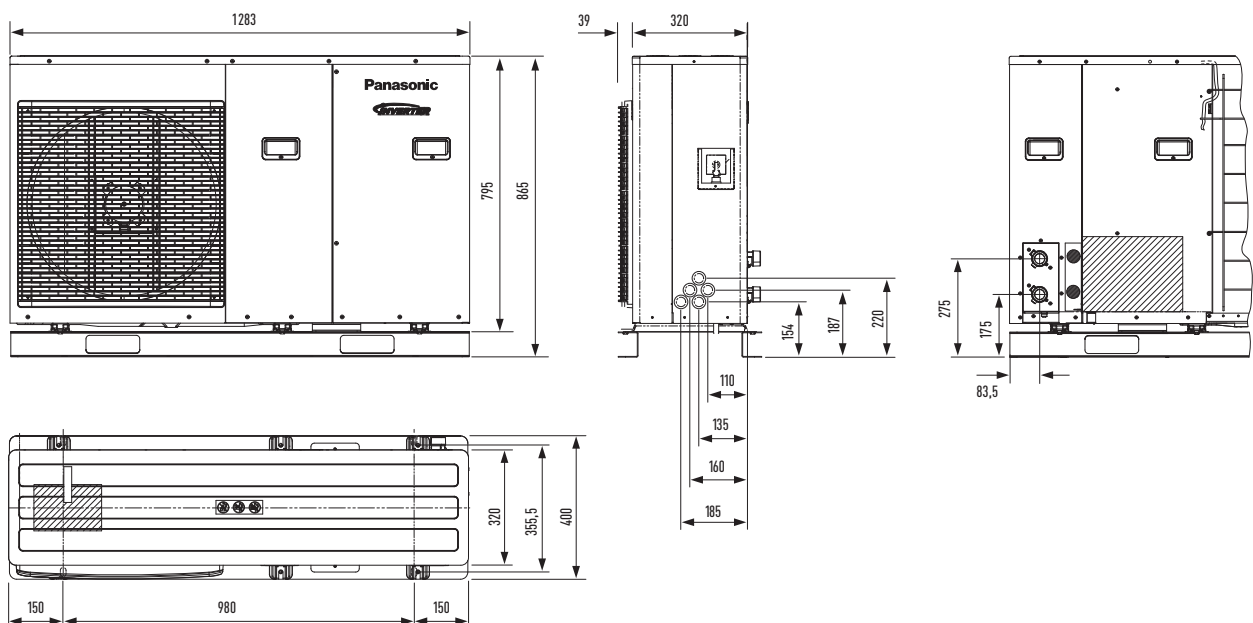



One Fan Outdoor Unit

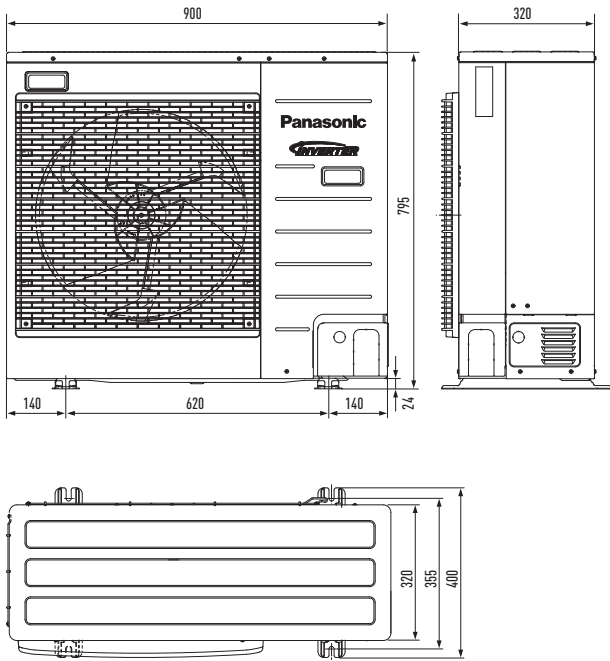

One Fan Outdoor Unit

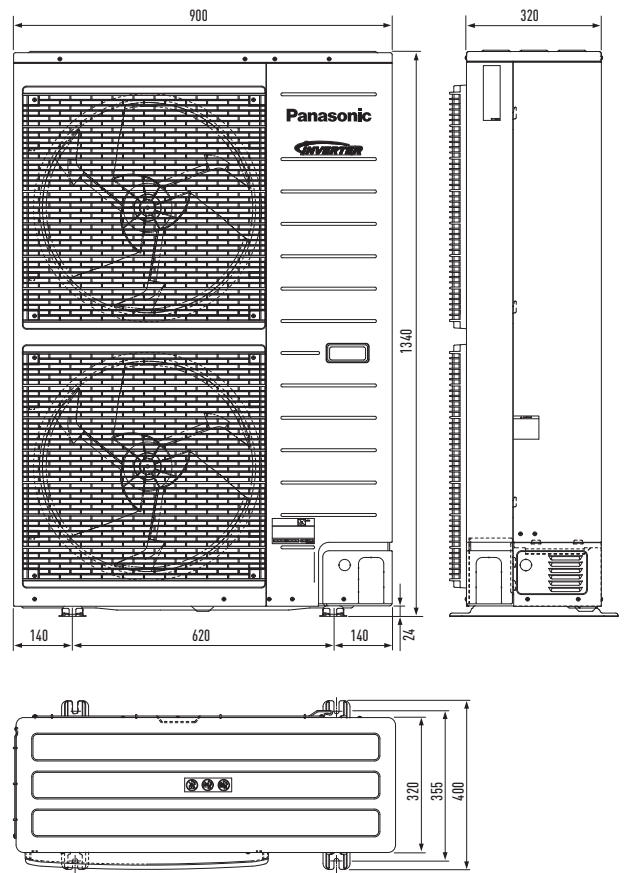

Mono-Bloc 9 to 16 kW

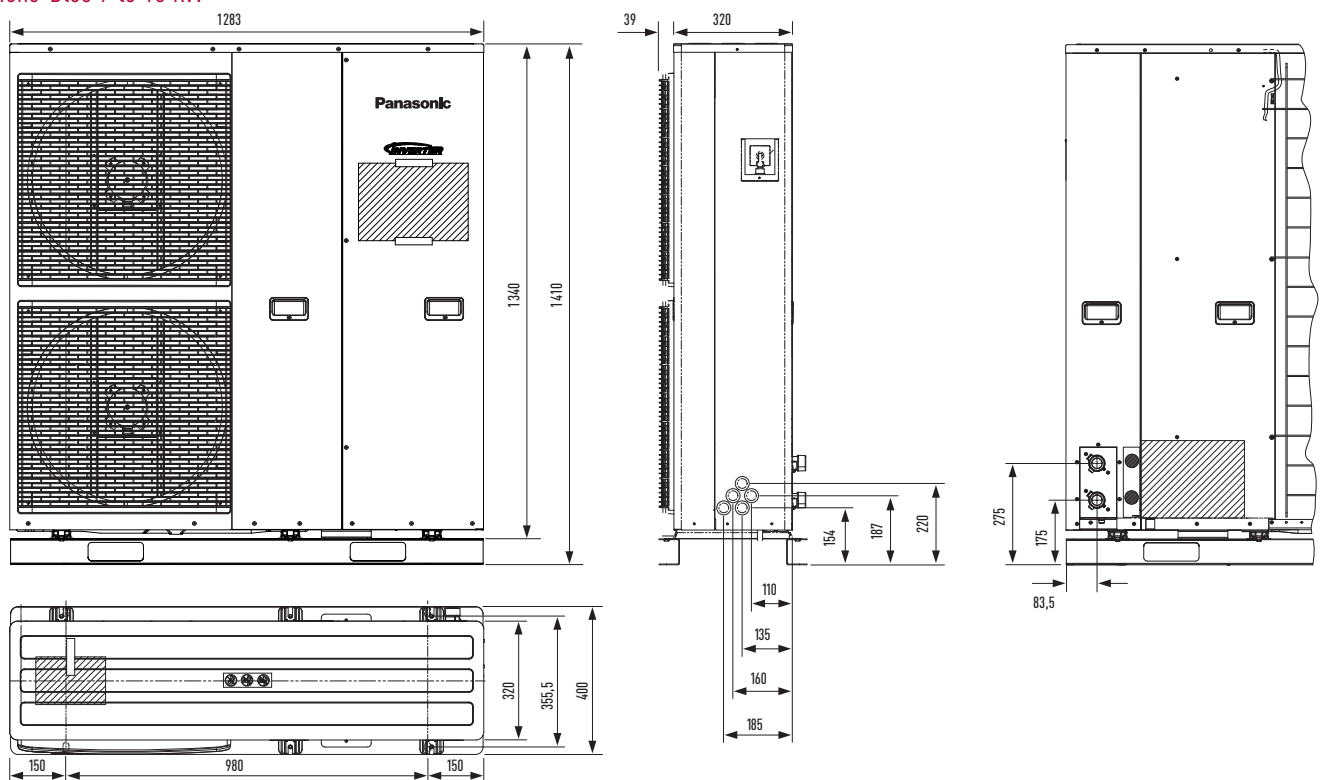

# Error Codes

The operation led blinks and an error code appears on the control panel display.

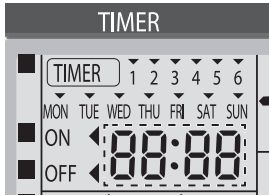

- Turn the unit off and inform the authorised dealer of the error code.
- The timer operation is cancelled when an error code occurs.

## Force Heater mode button

- The backup heater also serves as backup in case of malfunctioning of the outdoor unit.
- Press to stop the force heater operation.
- During Force Heater mode, all other operations are not allowed.

## Error Code List

Diagnosis display	Abnormality / Protection control	Abnormality Judgement	Primary location to verify
H00	No abnormality detected	—	—
H12	Indoor/Outdoor capacity unmatched	90s after power supply	<ul style="list-style-type: none"> <li>• Indoor/outdoor connection wire</li> <li>• Indoor/outdoor PCB</li> <li>• Specification and combination table in catalogue</li> </ul>
H15	Outdoor compressor temperature sensor abnormality	Continue for 5 sec.	• Compressor temperature sensor (defective or disconnected)
H23	Indoor refrigerant liquid temperature sensor abnormality	Continue for 5 sec.	• Refrigerant liquid temperature sensor (defective or disconnected)
H38	Indoor/Outdoor mismatch	—	• Indoor/Outdoor PCB
H42	Compressor low pressure abnormality	—	<ul style="list-style-type: none"> <li>• Outdoor pipe temperature sensor</li> <li>• Clogged expansion valve or strainer</li> <li>• Insufficient refrigerant</li> <li>• Outdoor PCB</li> <li>• Compressor</li> </ul>
H62	Water flow switch abnormality	Continue for 1 min.	• Water flow switch
H64	Refrigerant high pressure abnormality	Continue for 5 sec.	• Outdoor high pressure sensor (defective or disconnected)
H70	Back-up heater OLP abnormality	Continue for 60 sec.	• Back-up heater OLP (Disconnection or activated)
H72	Tank sensor abnormal	Continue for 5 sec.	• Tank sensor
H76	Indoor - control panel communication abnormality	—	• Indoor - control panel (defective or disconnected)
H90	Indoor / outdoor abnormal communication	> 1 min after starting operation	<ul style="list-style-type: none"> <li>• Internal / external cable connections</li> <li>• Indoor / Outdoor PCB</li> </ul>
H91	Tank heater OLP abnormality	Continue for 60 sec.	• Tank heater OLP (Disconnection or activated)
H95	Indoor/Outdoor wrong connection	—	• Indoor/Outdoor supply voltage
H98	Outdoor high pressure overload protection	—	<ul style="list-style-type: none"> <li>• Outdoor high pressure sensor</li> <li>• Water pump or water leakage</li> <li>• Clogged expansion valve or strainer</li> <li>• Excess refrigerant</li> <li>• Outdoor PCB</li> </ul>
H99	Indoor heat exchanger freeze prevention	—	<ul style="list-style-type: none"> <li>• Indoor heat exchanger</li> <li>• Refrigerant shortage</li> </ul>
F12	Pressure switch activate	4 times occurrence within 20 minutes	• Pressure switch
F14	Outdoor compressor abnormal revolution	4 times occurrence within 20 minutes	• Outdoor compressor
F15	Outdoor fan motor lock abnormality	2 times occurrence within 30 minutes	<ul style="list-style-type: none"> <li>• Outdoor PCB</li> <li>• Outdoor fan motor</li> </ul>
F16	Total running current protection	3 times occurrence within 20 minutes	<ul style="list-style-type: none"> <li>• Excess refrigerant</li> <li>• Outdoor PCB</li> </ul>
F20	Outdoor compressor overheating protection	4 times occurrence within 30 minutes	<ul style="list-style-type: none"> <li>• Compressor tank temperature sensor</li> <li>• Clogged expansion valve or strainer</li> <li>• Insufficient refrigerant</li> <li>• Outdoor PCB</li> <li>• Compressor</li> </ul>
F22	IPM (power transistor) overheating protection	3 times occurrence within 30 minutes	<ul style="list-style-type: none"> <li>• Improper heat exchange</li> <li>• IPM (Power transistor)</li> </ul>
F23	Outdoor Direct Current (DC) peak detection	7 times occurrence continuously	<ul style="list-style-type: none"> <li>• Outdoor PCB</li> <li>• Compressor</li> </ul>
F24	Refrigeration cycle abnormality	2 times occurrence within 20 minutes	<ul style="list-style-type: none"> <li>• Insufficient refrigerant</li> <li>• Outdoor PCB</li> <li>• Compressor low compression</li> </ul>
F25	Cooling / Heating cycle changeover abnormality	4 times occurrence within 30 minutes	<ul style="list-style-type: none"> <li>• 4-way valve</li> <li>• V-coil</li> </ul>
F27	Pressure switch abnormality	Continue for 1 min.	• Pressure switch
F36	Outdoor air temperature sensor abnormality	Continue for 5 sec.	• Outdoor air temperature sensor (defective or disconnected)
F37	Indoor water inlet temperature sensor abnormality	Continue for 5 sec.	• Water inlet temperature sensor (defective or disconnected)
F40	Outdoor discharge pipe temperature sensor abnormality	Continue for 5 sec.	• Outdoor discharge pipe temperature sensor (defective or disconnected)
F41	PFC control	4 times occurrence within 10 minutes	• Voltage at PFC
F42	Outdoor heat exchanger temperature sensor abnormality	Continue for 5 sec.	• Outdoor heat exchanger temperature sensor (defective or disconnected)
F43	Outdoor defrost sensor abnormality	Continue for 5 sec.	• Outdoor defrost sensor (defective or disconnected)
F45	Indoor water outlet temperature sensor abnormality	Continue for 5 sec.	• Water outlet temperature sensor (defective or disconnected)
F46	Outdoor Current Transformer open circuit	—	<ul style="list-style-type: none"> <li>• Insufficient refrigerant</li> <li>• Outdoor PCB</li> <li>• Compressor low</li> </ul>
F95	Cooling high pressure overload protection	—	<ul style="list-style-type: none"> <li>• Outdoor high pressure sensor</li> <li>• Water pump or water leakage</li> <li>• Clogged expansion valve or strainer</li> <li>• Excess refrigerant</li> <li>• Outdoor PCB</li> </ul>
F48	Outdoor EVA outlet temperature sensor abnormality	Continue for 5 sec.	• Outdoor EVA outlet temperature sensor (defective or disconnected)
F49	Out bypass outlet temperature sensor abnormality	Continue for 5 sec.	• Outdoor bypass outlet temperature sensor (defective or disconnected)

**Panasonic**

**[www.panasonic.eu](http://www.panasonic.eu)**

heatingandcoolingsystems

Due to the ongoing innovation of our products, the specifications of this catalogue are valid barring typographic errors, and may be subject to minor modifications by the manufacturer without prior warning in order to improve the product. The total or partial reproduction of this catalogue is prohibited without the express authorisation of Panasonic UK Ltd.



**[www.panasonic-heating.com](http://www.panasonic-heating.com)**

Visit the AQUAREA website for more information. The Aquarea website has been designed to show you how you can save money on your heating bills when you install a Panasonic Aquarea Air Source Heat Pump System.

# Panasonic®

To find out how Panasonic cares for you,  
log on to: [www.panasonic.eu](http://www.panasonic.eu)

**Contact Details:**

Telephone: 01344 853182  
[www.panasonic.co.uk/aircon](http://www.panasonic.co.uk/aircon)

**Address: Panasonic Air Conditioning**

Panasonic House  
Willoughby Road  
Bracknell  
Berkshire  
RG12 8FP

