

Panasonic Commercial air to air

Panasonic has developed an impressive range of highly efficient Commercial Air Conditioners. This range confirms our commitment to the environment, with our highly efficient Inverter compressor technology to optimise performance.

PACi





Highlighted features	→ 156
Product quality and safety	→ 158
PACi NX Series	→ 160
PACi NX Series 4	→ 162
CONEX. Devices and apps	→ 164
Commercial Wi-Fi Adaptor	→ 165
Bringing nature's balance indoors	→ 166
PACi NX 4 way 90x90 cassette - PU3	→ 168
PACi NX adaptive ducted unit - PF3	→ 170
BION air pollutant filter	→ 172
PACi NX wall-mounted, 4 way 60x60 cassette and ceiling	→ 174
High static pressure hide-away 20,0-25,0 kW - PE4, PE3	→ 176
Solutions for server rooms applications	→ 178

Commercial units range	→ 180
Wall-mounted Professional Inverter -25 °C	→ 182
Elite - Standard wall-mounted · R32	→ 184
Elite - Standard 4 way 60x60 cassette · R32	→ 188
Elite - Standard 4 way 90x90 cassette · R32	→ 190
Elite - Standard ceiling · R32	→ 194
Elite - Standard adaptive ducted unit · R32	→ 198
Big PACi NX high static pressure hide-away · R32	→ 202
Big PACi high static pressure hide-away · R32	→ 203

Commercial PACi NX Multi	→ 204
Commercial twin, triple and double-twin systems · R32	→ 206

Hydronic PACi	
Panasonic PACi with Water Heat Exchanger	→ 210

Ventilation	
AHU connection kit PAH3M for PACi NX and PACi	→ 214
Electric air curtain	→ 215
Air curtain with DX coil, connected to PACi NX and PACi	→ 216
Ceiling mounted air-e nanoe X Generator	→ 217

R22 Renewal. Fast, easy to install and cost effective	→ 218
---	-------

Accessories and control	→ 222
-------------------------	-------

Eurovent certified technical data	→ 228
-----------------------------------	-------

Highlighted features

PACi: Commercial air to air. The compact and high efficiency solution for shops, restaurants, offices or residential applications.



Great savings and improved comfort. Panasonic has developed an impressive range of highly efficient Commercial air conditioners, with our highly efficient Inverter compressor technology to optimise performance.

A wide range for industry, office or residential application. With configuration from 1:1 to 4:1, Panasonic can offer the most comfortable climate with solutions designed for every environment.

The diverse array of connectivity and control systems allows you to manage your units whether locally or remotely. Receive real-time status updates and maintenance alerts, while optimising costs and energy usage.

Energy saving



Refrigerant R32.

Our heat pumps containing R32 refrigerant show a drastic reduction in the value of Global Warming Potential (GWP).



Exceptional seasonal cooling efficiency based on the ErP regulation.

9,6 SEER

Higher SEER ratings mean greater efficiency and year-round cooling savings!



Exceptional seasonal heating efficiency based on the ErP regulation.

5,1 SCOP

Higher SCOP ratings mean greater efficiency and year-round heating savings!



Econavi.

Intelligent human activity sensor and sunlight sensor technologies that can detect and reduces the waste of energy by optimising air conditioner operation according to room conditions. With just one touch of a button, you can save energy.



Inverter Plus system.

Inverter Plus system classification highlights Panasonic's highest performing systems.



Inverter.

The Inverter range provides greater efficiency and comfort. Provides more precise temperature control, without highs and lows, and keeps the ambient temperature constant with lower energy consumption and a significant reduction in noise and vibration levels.



High efficiency compressor.

Panasonic Big PACi has compressors that operate with a wider Hz range realize a more efficient operation throughout the year.



Panasonic R2 rotary compressor.

Designed to withstand extreme conditions, it delivers high performance and efficiency.



Better efficiency and value for low temperature applications.

ErP 35°C

On an energy efficiency scale from D to A+++ , both the PACi Water Heat Exchanger provide A++ rated heating.

High performance and indoor air quality



Down to -20 °C in cooling mode.



The air conditioner works in cooling mode when the outdoor temperature of -20 °C.



Down to -20 °C in heating mode.



The air conditioner works in heat pump mode when the outdoor temperature is as low as -20 °C.



nanoe™ X.



Technology with the benefits of hydroxyl radicals has the capacity to inhibit pollutants, viruses, and bacteria to clean and deodorise.



Super Quiet.



With Super Quiet technology our devices are quieter than a library (30 dB(A)).



DC fan.

Safe and precise.



Filter included.

Hide-away with filter included.



Bluefin.

Panasonic Big PACi has extended the life of its condensers with an original anti-rust coating.



Large fan.

Panasonic Big PACi large fan provides larger air flow rate and very quiet operation at low speed.



More comfort with Aerowings.

Panasonic's Aerowings feature incorporates two blades that concentrate the airflow to cool or heat in the shortest possible time by distributing the air evenly throughout the room. For wall-mounted YKEA.



Up to 46 °C in cooling mode.



PACi with Water Heat Exchanger system works in cooling mode at outdoor temperature up to 46 °C.



R410A/R22 renewal.

The Panasonic renewal system allows good quality existing R410A or R22 pipe work to be re-used whilst installing high efficiency R32 systems.



5 Years compressor warranty.

We guarantee the outdoor unit compressors in the entire range for five years.

High connectivity



Panasonic AC Smart Cloud.

The AC Smart Cloud from Panasonic allows you to have complete control of all your installations. In a simple click, receive status updates from all your units in real-time, preventing breakdowns and optimising costs.



Internet control.

A next generation system providing user-friendly control of air conditioning or heat pump units from everywhere, using a simple Android™ or iOS smartphone or tablet via Wi-Fi.



BMS connectivity.

The communication port can be integrated into the indoor unit and provides easy connection to, and control of, your Panasonic air conditioner to your home or Building Management System.



Domestic integration to S-Link - CZ-CAPRA1.

Can connect RAC range to S-Link. Full control is now possible.



Advanced control.

A touch screen remote controller is included as a standard. Clean design, easy operation and quick access to all menus.

Product quality and safety

All Panasonic air conditioners undergo strict quality and safety tests before sale. This rigorous process includes obtaining all necessary safety approvals, to ensure that all air conditioners we sell are not only built to the highest market standards, but are also completely safe.



Professional air conditioners with R32 refrigerant.

Panasonic recommends R32, with lower Global Warming Potential (GWP). Compared to R22 and R410A, R32 has a low potential impact on global warming.

Panasonic takes action in helping to protect the environment. In line with the European countries participating in the Montreal Protocol, protecting the ozone layer and preventing global warming, Panasonic is leading the switch to R32.

1 Installation innovation

- Extremely easy to install, practically the same as R410A
- Single substance refrigerant, which makes it easier to recycle and reuse

2 Environmental innovation

- Zero impact on the ozone layer
- 75% less impact on global warming

3 Economic and energy consumption innovation

- Lower cost and greater savings
- Higher energy efficiency than R410A

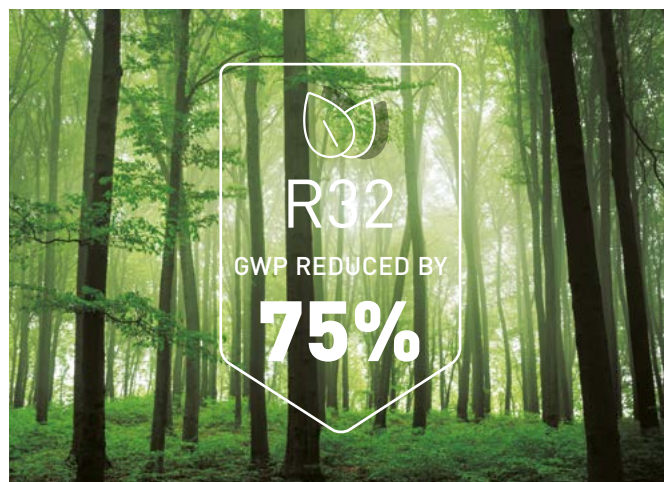

PACi NX Elite: Top-tier commercial air conditioning

The PAC NX Elite range has been expanded to include the Big PACi NX models 20,0-25,0 kW.

Outstanding performance at extreme ambient temperatures with very high energy efficiency both in heating and cooling. Fans, fan motors, compressors and heat exchangers engineered for maximum savings result in higher seasonal efficiencies, which ranks as one of the best in the industry, ensuring reduced CO₂ emissions, energy consumption and operating costs.

From 3,6 to 25,0 kW.

- Meeting all necessary approvals to ensure quality and safety

- Top class SEER: 8,9 A+++ / SCOP: 5,1 A+++ at 3,6 kW (in 90x90 cassette)
- A compact outdoor unit featuring a single fan across all the capacities
- Long piping allowance, maximum 100 m ¹⁾
- Wide operation range, up to 52 °C in cooling and down to -20 °C in heating
- Auto restart after power outage
- Twin, triple and double-twin connections
- Compatible with AHU connection kit

1) For models 10,0 - 25,0 kW.

PACi NX Standard: For economy and value

With high quality design and engineering, the PACi NX Standard are the perfect solutions for projects which demand quality on a limited budget. In addition, compact and lightweight design makes them ideal for installations with limited space including small commercial and residential applications. The slim and lightweight outdoor unit design enables installation even in very challenging locations.

From 2,5 to 14,0 kW.

- Extended range of outdoor units starting from 2,5 kW
- Great balance of system cost and performance
- Top class SEER / SCOP in the standard Inverter category SEER: 8,1 A++ / SCOP: 4,8 A++ at 3,6 kW (in 90x90 cassette)
- Variety of individual and central controllers which provides full flexibility
- Compact outdoor units, small footprint and lightweight
- Twin connection possible from 10,0 to 14,0 kW
- Operation range, up to 43 °C in cooling and down to -15 °C in heating

Big PACi

20,0-25,0 kW is ideally suited for small and mid retail applications.

In addition to its lightweight, split-able, compact body, the hide-away unit enables easy installation and pipe work within a narrow void.

Panasonic Big PACi: Environmental friendly, strong and flexible.

- High efficiency with Panasonic compressor as the driving force

- Compact and light indoor body
- Easy pipe work with split-able hide-away indoor design
- Separable indoor unit allows for flexible installation to fit in narrow void
- Water heat exchanger and AHU connection compatibility
- Bluefin anti-corrosion coating of the heat exchanger as standard
- Wide range of controls including Cloud Control compatibility

PACi NX Series. The next generation is here

NX Series with R32 refrigerant has been developed to meet the demand of easy refurbishment with 3 wire method.

Integrated with IoT solutions and includes nanoe™ X function as standard.

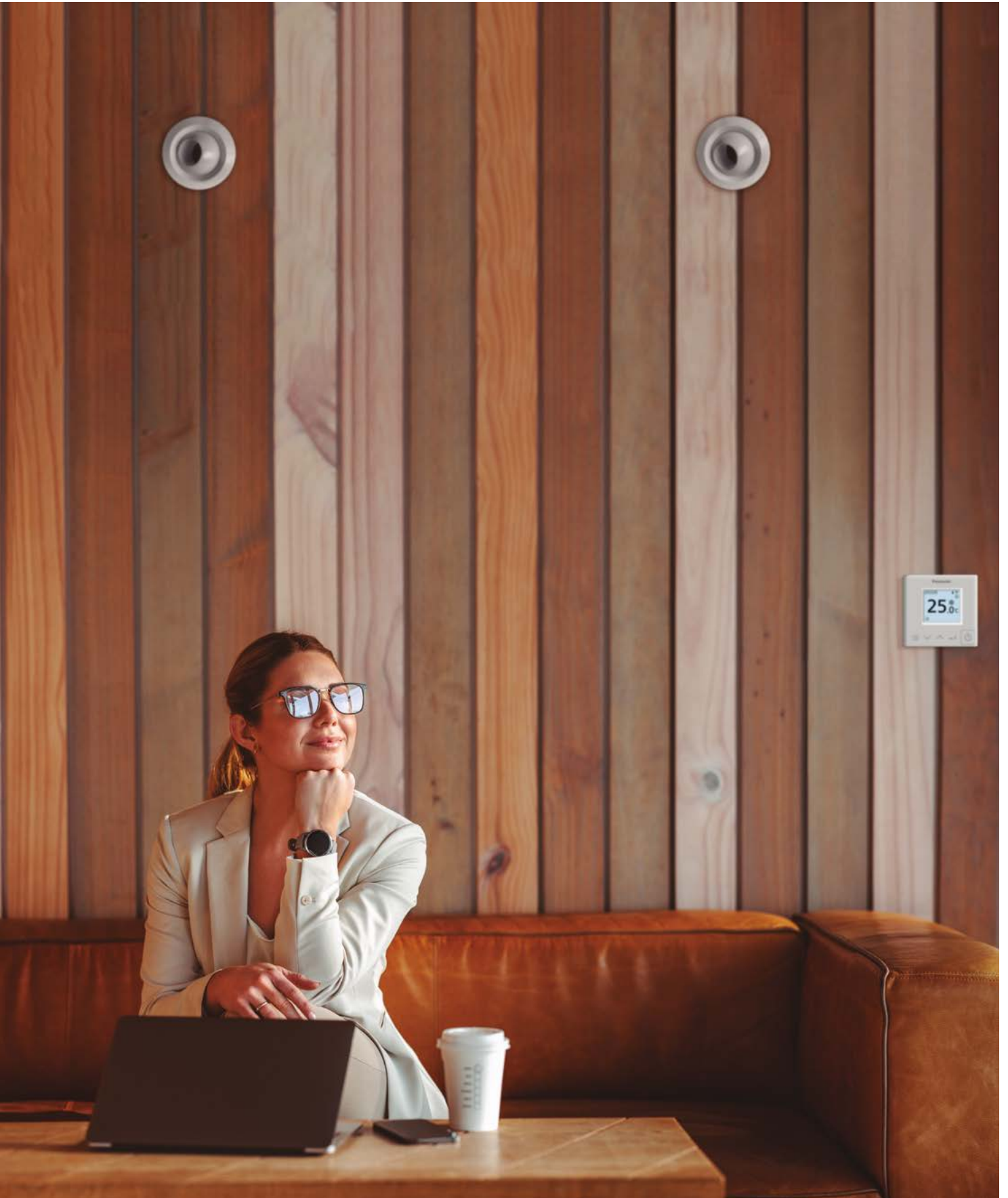

1 PACi NX Series for absolute ease of refurbishment

This series have been developed with 3 wire power and communication. It makes it simple and easy to replace old systems with 3 wire connections, which is prevalent in many systems.

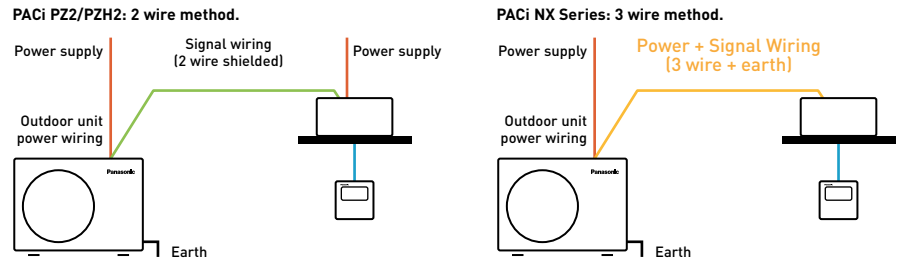

2 CONEX with IoT integration

The wired remote controller series is fully integrated with IoT solutions developed by Panasonic. Detailed operation, maintenance setting and service operation are all possible with smartphone or tablet.

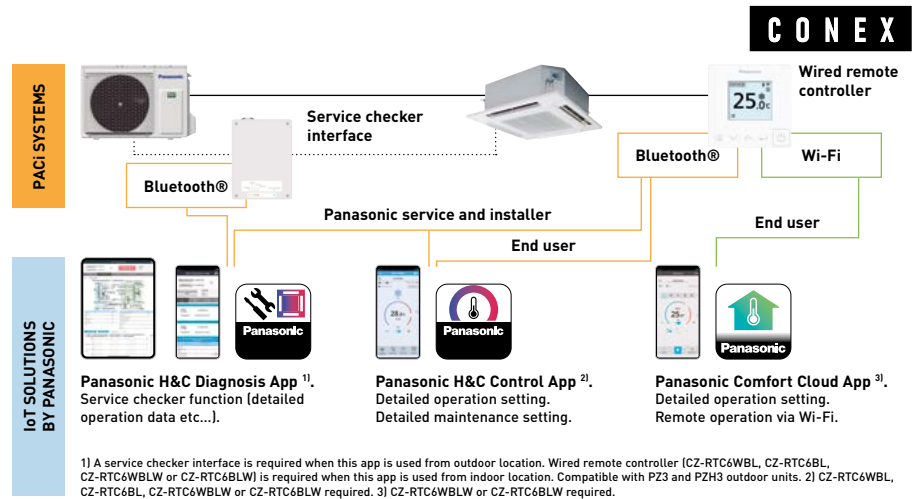

3 Let Panasonic take care of indoor air quality

Thanks to the nanoe™ X properties, several types of pollutants can be inhibited such as certain types of bacteria, viruses, mould, allergens, pollen and certain hazardous substances. This unique technology is equipped to provide better air quality whether residential or commercial.



7 effects of nanoe™ X – Panasonic unique technology.

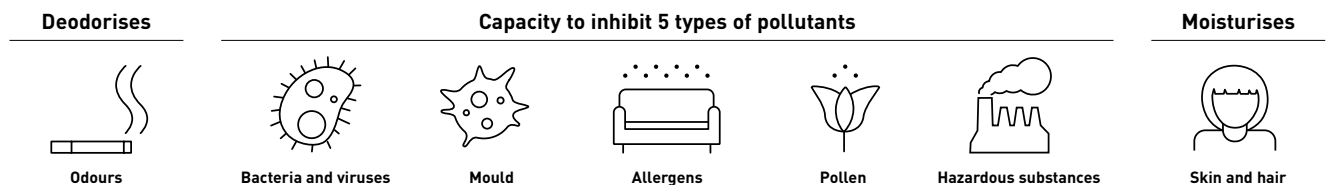

The nanoe™ X performance varies depending on the room size, environment and usage and it may take several hours to reach the full effect. nanoe™ X is not medical device, local regulations on building design and sanitary recommendations must be followed.

➤ REFER TO PAGE 12 FOR MORE DETAILS AND VALIDATION DATA

4 Increasing the efficiency

The PACi NX Series have improved seasonal efficiencies in both heating and cooling versus the previous generation.

Energy class ¹⁾ and seasonal efficiency value ($\eta_{s,c} / \eta_{s,h}$) ²⁾																
kW	Wall-mounted - PK3		4 way cassette - PY3		4 way cassette - PU3		Ceiling - PT3		Adaptive ducted - PF3		Hide-away - PE4					
	Elite	Standard	Elite	Standard	Elite	Standard	Elite	Standard	Elite	Standard	Elite					
2,5	🌟🌟🌟	🌟🌟🌟	🌟🌟🌟	🌟🌟🌟	🌟🌟🌟	🌟🌟🌟	🌟🌟🌟	🌟🌟🌟	🌟🌟🌟	🌟🌟🌟	🌟🌟🌟	🌟🌟🌟	🌟🌟🌟			
3,6	A++	A++	A++	A+	A++	A++	A++	A++	A++	A+	A+	A+	A+			
5,0	A++	A++	A++	A+	A+++	A++	A++	A++	A+	A+	A+	A++	A+			
6,0	A++	A++	A++	A+	A++	A++	A++	A++	A++	A+	A+	A++	A+			
7,1	A++	A++	A+	A+	A++	A++	A++	A+	A+	A+	A+	A+	A+			
10,0	A++	A	A++	A	A++	A++	A++	A+	A++	A+	A++	A				
12,5					304,3%	186,0%	267,0%	157,0%	278,4%	175,6%	241,7%	147,4%	281,7%	165,0%	257,4%	142,6%
14,0					286,6%	181,2%	257,0%	152,2%	263,3%	169,3%	228,8%	145,3%	275,9%	162,6%	252,2%	140,6%
20,0															237,8%	146,0%
25,0															213,0%	145,0%

1) Energy label scale from A+++ to D for models below 12,0 kW (EU regulation 626/2011). 2) $\eta_{s,c} / \eta_{s,h}$ values for models above 12,0 kW (EN 14825).

PACi NX Elite Series 4



The compact chassis newly designed with one fan up to 25,0 kW, will fit in limited installation space.

- A compact outdoor unit featuring a single fan across all the capacities up to 25,0 kW.
- With the unit weighting only 66 kg*, it is easy to carry and easy to install.

* For model 7,1 kW.



PACi NX Elite from 7,1 to 14,0 kW

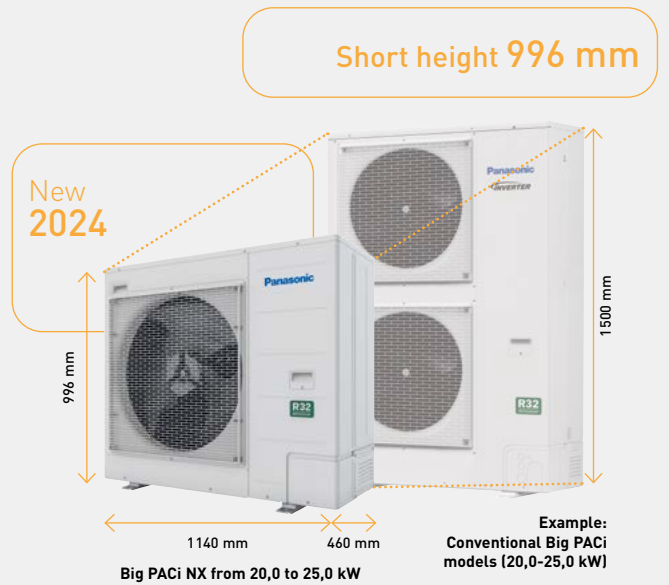

Short height 996 mm

New 2024

996 mm

Big PACi NX from 20,0 to 25,0 kW

Example: Conventional Big PACi models (20,0-25,0 kW)

Highly efficient performance in a compact body

One fan outdoor units keep the excellent seasonal performance by optimizing the layers of the heat exchanger. As a result, PZH4 Series provide the equivalent high seasonal performance to conventional 2 fan models.

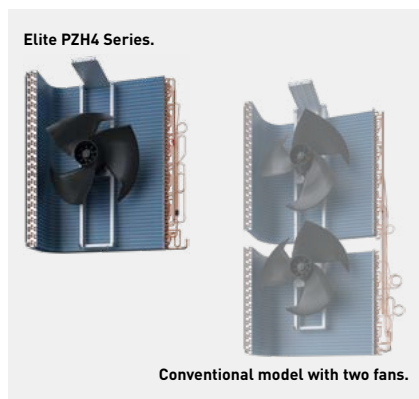

PZH4 Series seasonal performance.

SEER / SCOP

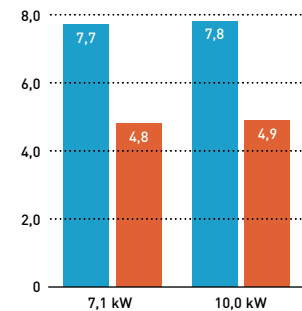

$\eta_{s,c} / \eta_{s,h}$

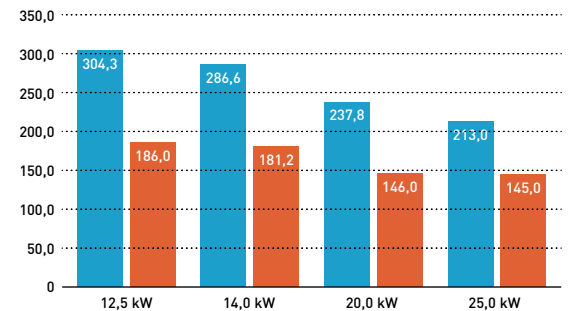

* Performance tested with a 4-way cassette90x90 cassette for 7.1 to 14 kW and a high static pressure hideaway for 20-25 kW.

SEER SCOP

Extended operation range up to 52 °C in cooling and down to -20 °C in heating

Upgraded PACi NX Elite Series are capable of working even in the challenging ambient conditions. Cooling operation is possible when outdoor temperature is as low as -20 °C* or as high as 52 °C. Heating operation can also be utilized at outdoor temperatures down to -20 °C when outdoor temperature is as low as -20 °C.

* For models 10,0 ~ 25,0 kW with pipe length up to 30 m.

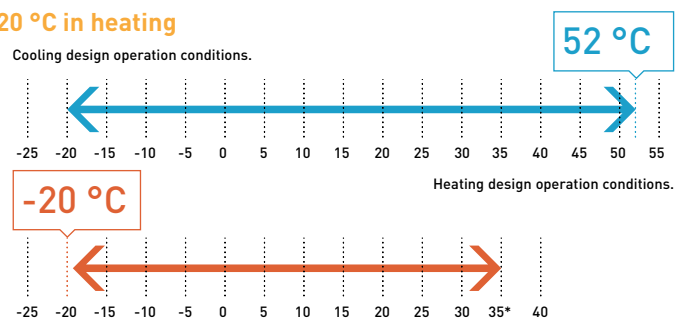

* For models 20,0 ~ 25,0 kW.

Long piping allowance maximum 100 m*

Increased piping length gives great design flexibility to adapt various building types and sizes. Piping length: 100 m (10,0 to 25,0 kW), 60 m (7,1 kW)

* For models 10,0 ~ 25,0 kW.

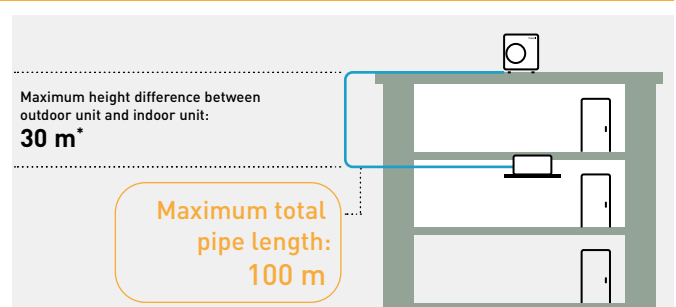

* 15 m if the outdoor unit is below the indoor unit.

CONEX. Devices and apps

CONEX provides comfort and control for varying user needs. Accessible, flexible and scalable with different controllers and apps. Perfectly meeting requirements of modern controls for end user, installer and service.

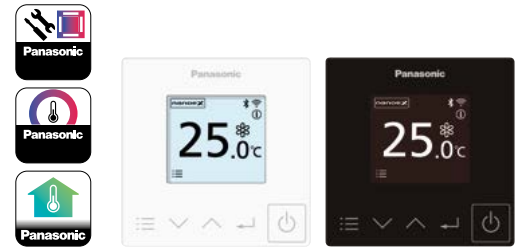

- 1 Intuitive control with stylish design**
- Simple operation at a glance
 - Clean face with full flat and LCD display
 - Compact body, only 86x86 mm

- 2 Control comfort with your smartphone**
- Flexible control options with IoT integration
 - Panasonic H&C Control App for daily remote control operation
 - Panasonic Comfort Cloud App for remote operation 24/7/365

- 3 Easy maintenance with service support app**
- Quick and easy app set-up for system setting
 - Panasonic H&C Diagnosis App enables the user to obtain detailed system operation data

* The use of apps depends on the remote controller model.

CONEX with IoT integration



The wired remote controller series is fully integrated with IoT solutions developed by Panasonic. Detailed operation, maintenance setting and service operation are all possible with smartphone or tablet.

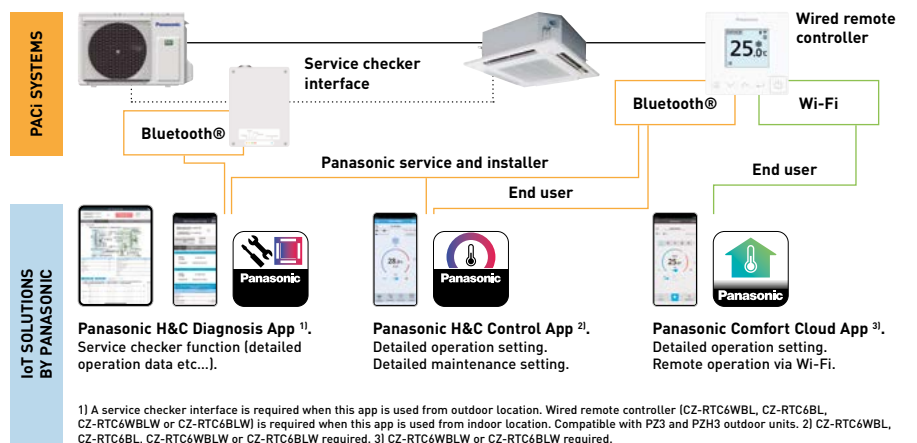

White model	CZ-RTC6W	CZ-RTC6WBL	CZ-RTC6WBLW
Black model	CZ-RTC6	CZ-RTC6BL	CZ-RTC6BLW
Wired connection compatible with	PACi, PACi NX, ECOi, GHP	PACi, PACi NX, ECOi, GHP	PACi NX only
Wireless functions	No wireless capability	Bluetooth®	Bluetooth® + Wi-Fi
App compatibility			
Panasonic Comfort Cloud App	—	—	✓
Panasonic H&C Control App	—	✓ PACi, PACi NX, ECOi, GHP	✓ PACi NX only
Panasonic H&C Diagnosis App ¹⁾	—	✓ PACi NX only ²⁾	✓ PACi NX only ²⁾
Outdoor unit settings (remote controller connected to indoor unit)	✓ PACi NX only ²⁾	✓ PACi NX only ²⁾	✓ PACi NX only ²⁾

1) Compatible with U-71/100/125/140PZH3E5/8 and U-100/125/140PZ3E5/8. 2) When connected to PACi NX indoor and outdoor unit combination.

Commercial Wi-Fi Adaptor

Panasonic CZ-CAPWFC1 interface adaptor, allows connection of one or a group of indoor units to Panasonic Comfort Cloud App, which provides control, monitoring, scheduling and error alerts.



Advanced smartphone control

Control PACi, ECOi and ECO G indoor units with your smartphone from wherever and whenever you are, by using Panasonic Comfort Cloud App and Commercial Wi-Fi Adaptor. This scalable solution is ideal for one system, one site or multiple locations. Coupling the adaptor with the already feature rich systems, makes it an ideal solution for residential and commercial applications.

1 From 1 to 200 units
User can control up to 10 different sites, with up to 20 units / groups per site. Additionally, one adaptor can be connected to 1 indoor or to a group of up to 8 indoors.

2 Voice control compatible
When registering the unit to Panasonic Comfort Cloud App makes it compatible with most popular voice assistants.

3 Multi user
The Panasonic Comfort Cloud App allows multi-user access control. Restrict user access to specific units.

4 Easy scheduling
Complex weekly scheduling made simple. Not only for one unit, but across multiple sites and from a smartphone.

5 Energy monitor
See the estimated power consumption and compare with other periods, to see how energy consumption can be reduced even more. Check list of units that provides consumption*.

6 Error codes
Error code notification through the App, provides early notification and allows for faster repair.

* Function available depending on the model.

Connection Diagram

Commercial Wi-Fi Adaptor wiring length is 1,9 m and connects to indoor unit via T10 connector and R1/R2 terminal connectors.

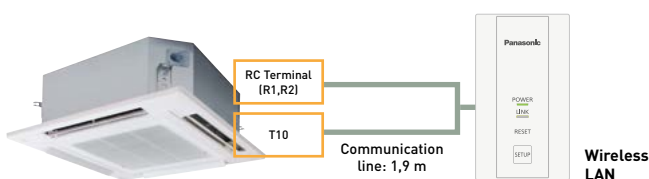

Input Voltage	DC 12 V (supplied from T10 connector)
Power Consumption	Maximum 2,4 W
Size (H x W x D)	120 x 70 x 25 mm
Weight	190 g (including communications lines)
Interface	1 x Wireless LAN
Wireless LAN Standard	IEEE 802,11 b/g/n
Frequency Range	2,4 GHz band
Operating range	0 ~ 55 °C, 20 ~ 80 RH%
Connectable indoor unit	1 unit
Length of communication line	1,9 m (included)

Download free app: Panasonic Comfort Cloud App.

Other hardware requirements: Router and Internet (purchase and subscribe separately).

Panasonic Cloud Server is designed, operated and managed by Panasonic.

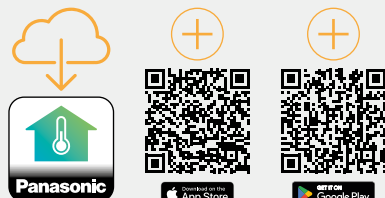

Bringing nature's balance indoors



nanoe™ X, technology with the benefits of hydroxyl radicals.

Abundant in nature, hydroxyl radicals (also known as OH radicals) have the capacity to inhibit pollutants, viruses, and bacteria to clean and deodorise. nanoe™ X technology can bring these incredible benefits indoors so that hard surfaces, soft furnishings, and the indoor environment can be a cleaner and more pleasant place to be, whether at home, work, or visiting hotels, shops and restaurants etc.



What is unique about nanoe™ X?

Effective on fabrics and surfaces.

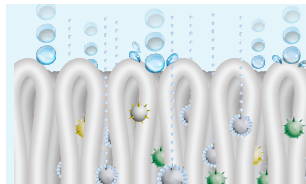

1 | At one billionth of a metre, nanoe™ X is much smaller than steam and can deeply penetrate cloth fabrics to deodorise.

Longer lifespan.



2 | Contained in tiny water particles, nanoe™ X has a long lifespan, which is about 600 seconds, to spread easily around the room.

Huge quantity.



3 | nanoe X Generator Mark 3 produces 48 trillion hydroxyl radicals per second. Greater amounts of hydroxyl radicals contained in nanoe™ X lead to higher performance on inhibition of pollutants.

Maintenance-free.

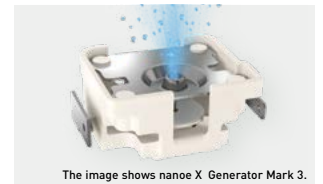

The image shows nanoe X Generator Mark 3.

4 | No service and maintenance required. nanoe™ X is a filter free solution that does not require maintenance, as its atomisation electrode is enveloped with water during its generation process and it is made with Titanium.

7 effects of nanoe™ X – Panasonic unique technology

Deodorises

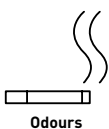

Odours

Capacity to inhibit 5 types of pollutants

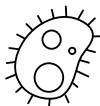

Bacteria and viruses

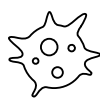

Mould

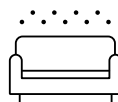

Allergens



Pollen



Hazardous substances



Skin and hair

* Refer to <https://aircon.panasonic.eu> for more details and validation data.

First nanoe™ device was developed by Panasonic in 2003

Generator: nanoe™

2003

480 billion hydroxyl radicals/sec

Ion particle structure

Hydroxyl radicals

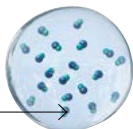

Generator: nanoe™ X

Mark 1 - 2016

4,8 trillion hydroxyl radicals/sec

10x times

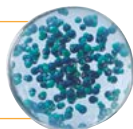

Mark 2 - 2019

9,6 trillion hydroxyl radicals/sec

20x times

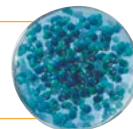

Mark 3 - 2022

48 trillion hydroxyl radicals/sec

100x times

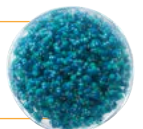

nanoe™ X, internationally-validated technology in testing facilities.

The effectiveness of nanoe™ X technology has been tested by 3rd party laboratories in Germany, France, Denmark, Japan and China.

The nanoe™ X performance varies depending on the room size, environment and usage and it may take several hours to reach the full effect. nanoe™ X is not medical device, local regulations on building design and sanitary recommendations must be followed. Test results conducted under controlled laboratory conditions. Performance of nanoe™ X might differ in real life environment.

	Tested contents	Generator	Result	Capacity	Time	Testing organisation	Report No.	
Airborne	Virus	Influenza (H1N1)	Mark 2	98,3% inhibited	30 m³	1,5 h	China Electronic Product Reliability and Environmental Testing Research Institute	J2003WT8888-00889
		Bacteriophage ΦX174	Mark 1	99,2% inhibited	Approx. 25 m³	6 h	Kitasato Research Center for Environmental Science	24_0300_1
	Bacteria	Staphylococcus aureus	Mark 1	99,7% inhibited	Approx. 25 m³	4 h	Kitasato Research Center for Environmental Science	24_0301_1
Adhering	Virus	SARS-CoV-2	Mark 1	91,4% inhibited	6,7 m³	8 h	Texcell (France)	1140-01 C3
		SARS-CoV-2	Mark 1	99,9% inhibited	45 L	2 h	Texcell (France)	1140-01 A1
		Bacteriophage ΦX174	Mark 1	99,8% inhibited	Approx. 25 m³	8 h	Japan Food Research Laboratories	13001265005-01
		Xenotropic murine leukemia virus	Mark 1	99,999% inhibited	45 L	6 h	Charles River Biopharmaceutical Services GmbH	—
		Coxsackie virus (CA16)	Mark 2	99,9%inhibited	30 m³	4 h	China Electronic Product Reliability and Environmental Testing Research Institute	J2002WT8888-00439
		Bacteriophage	Mark 3	98,81% inhibited	Approx. 139,3 m³	4 h	SGS Inc	SHES210901902584
	Bacteria	MS2 Phage Virus	Mark 3	99,99% inhibited	Approx. 25 m³	2 h	Shokukanken, Inc.	227131N
		Staphylococcus aureus	Mark 1	99,9% inhibited	20 m³	8 h	Danish Technological Institute	868988
	Pollen	Cedar pollen	Mark 3	99%inhibited	Approx. 24 m³	12 h	Panasonic Product Analysis Center	H21YA017-1
		Ambrosia pollen	Mark 1	99,4% inhibited	20 m³	8 h	Danish Technological Institute	868988
	Odours	Cigarette smoke odour	Mark 1	Odour intensity reduced by 2,4 levels	Approx. 23 m³	0,2 h	Panasonic Product Analysis Center	4AA33-160615-N04
			Mark 3	Odour intensity reduced 1,7 levels	Approx. 139,3 m³	0,5 h	SGS Inc	SHES210901902478

Licensed in VDI 6022

Certification of a HVAC system under VDI 6022 guarantees that the system fulfills the market's strictest hygiene requirements.



VDI 6022 – Part 5 ¹⁾ Certification.
Avoidance of allergenic exposure.
 Inhibits a wide range of harmful bacteria, viruses, mould, pollen and allergens.



VDI 6022 – Part 1 ¹⁾ & 1.1 ²⁾ Certification.
Ventilation and indoor-air quality.
 Panasonic nanoe™ X technology improving indoor air quality.

1) Certification mark only valid for nanoe X Generator Mark 3. 2) Certification mark only valid for nanoe X Generator Mark 2 and Mark 3.

nanoe™ X: improving protection 24/7.

Acts to clean your air, so that the indoor environment can be a cleaner and more pleasant place to be all day long. nanoe™ X works together with heating or cooling function when you are at home and can work independently when you are away. Give the air conditioning the strength to increase the protection at home with nanoe™ X technology and convenient control via the Panasonic Comfort Cloud App.

Cleans the air when you are away.
 Leave the nanoe™ mode ON to inhibit certain pollutants and deodorise before you return home.

Improves your environment when you are at home.
 Enjoy a cleaner, comfortable space with loved ones.

Panasonic Heating & Cooling Solutions is incorporating nanoe™ technology in a wide range of equipment

- 

Wall-mounted.
Built-in nanoe X Generator Mark 2.



Ceiling.
Built-in nanoe X Generator Mark 2.
- 

4 Way 60x60 cassette.
Built-in nanoe X Generator Mark 2.



Adaptive ducted unit.
Built-in nanoe X Generator Mark 2.
- 

4 Way 90x90 cassette.
Built-in nanoe X Generator Mark 1.



High static pressure hide-away.
Built-in nanoe X Generator Mark 3.
- 

Ceiling mounted air-e nanoe X Generator.
Built-in nanoe X Generator Mark 1.

PACi NX 4 way 90x90 cassette - PU3

These cassettes offer upgraded nanoe™ X and Econavi technologies to make the room air more comfortable and healthy and to increase the energy efficiency.





+ SEE PRODUCT SPECIFICATIONS

1 Improved indoor air quality with nanoe™ X and fresh air intake

- nanoe™ X technology equipped as standard for improved indoor air quality
- Internal cleaning function for the unit with nanoe™ X
- High external fresh air intake volume with optional kit (CZ-FDU3 + CZ-ATU2)

2 Superior energy efficiency and comfort

- High seasonal efficiency both in heating and cooling, maximum SEER: 8,9 A+++ / SCOP: 5,1 A+++*
- Econavi: Intelligent sensors to increase energy savings and comfort
- Super Quiet operation down to 27 dB(A)

* For 3,6 kW model.

3 Easy installation

- Light weight, easy piping and integrated drain pump for quick installation
- Wired remote controller CZ-RTC6WBL and CZ-RTC6BL allows easy system setting via Bluetooth®

Always fresh and clean air with nanoe™ X

The 4 way 90x90 cassette with nanoe™ X, when tested, has shown to inhibit hazardous substances by 92%, when compared to natural reduction*. In addition to the 7 effects of nanoe™ X, the indoor unit can also be cleaned with a short operation of nanoe™ X + dry mode.

* Controllers (CZ-RTC5B, CZ-RTC6W/BL/BLW or CZ-RTC6/BL/BLW) are required.

After cooling/drying operation, the inside of the indoor unit is automatically dried and nanoe™ X is activated to suppress mould growth.

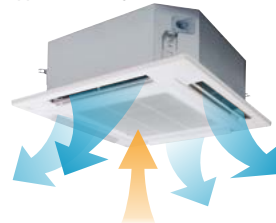

Operates the fan to discharge internal humidity.

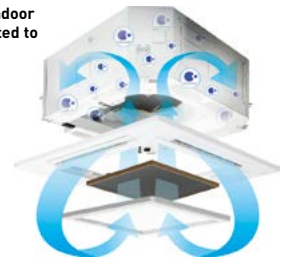

Operate the fan to circulate nanoe™ X internally.

nanoe™ X effect against odour proven in large space

92% of hexadecane ¹⁾ is inhibited after 8-hours exposure in room side 267 m².

Hexadecane inhabitation ratio [%].

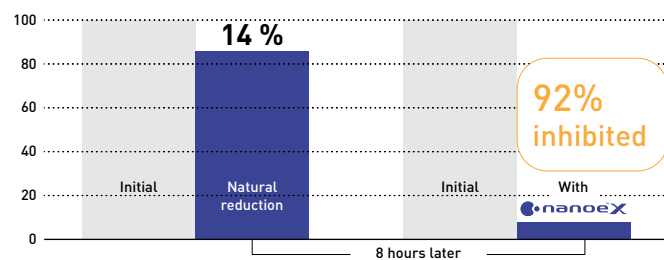

Test ambient.

3rd party certification organization SIRIM ²⁾ conducted the performance experiment of 4 way cassette equipped with nanoe X Generator Mark 1 device in inhibiting hexadecane, a chemical contaminant.

¹⁾ Hexadecane is a hazardous substance contained in gasoline and diesel exhaust gas, and considered to be one cause of oil odour. ²⁾ SIRIM Berhad (SIRIM), a premier industrial research and technology organization in Malaysia, wholly-owned by the Ministry of Finance Incorporated.

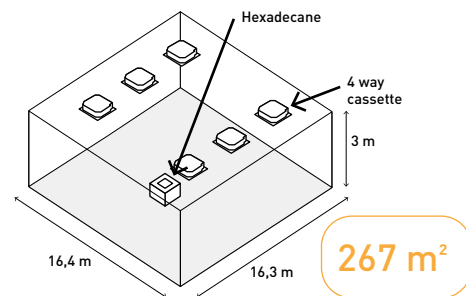

Optional Econavi intelligent sensor

Human activity sensor and floor temperature sensor can reduce waste energy, by optimising air conditioner operation.

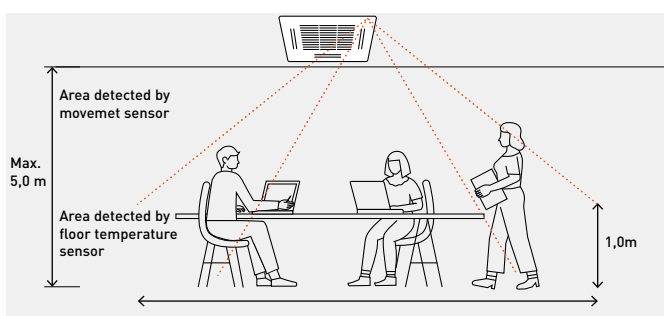

Advanced Econavi functions.

2 sensors (movement and floor temperature) can provide a reduction in wasted energy by means of effective control. The floor temperature can be detected with a ceiling height of up to 5 m.



Econavi exclusive panel. Optional (CZ-KPU3AW)



Floor temperature sensor.
This sensor detects average floor temperature and operates circulation if floor temperature is low.

Movement sensor.
This sensor detects the amount of human activity, and operates effectively.



Wired remote controller CZ-RTC5B, CZ-RTC6W/BL/BLW or CZ-RTC6/BL/BLW is required.

PACi NX adaptive ducted unit - PF3

The adaptive ducted units provide better flexibility with both installation possibilities, horizontal and vertical. The powerful external static pressure, maximum 150 Pa.

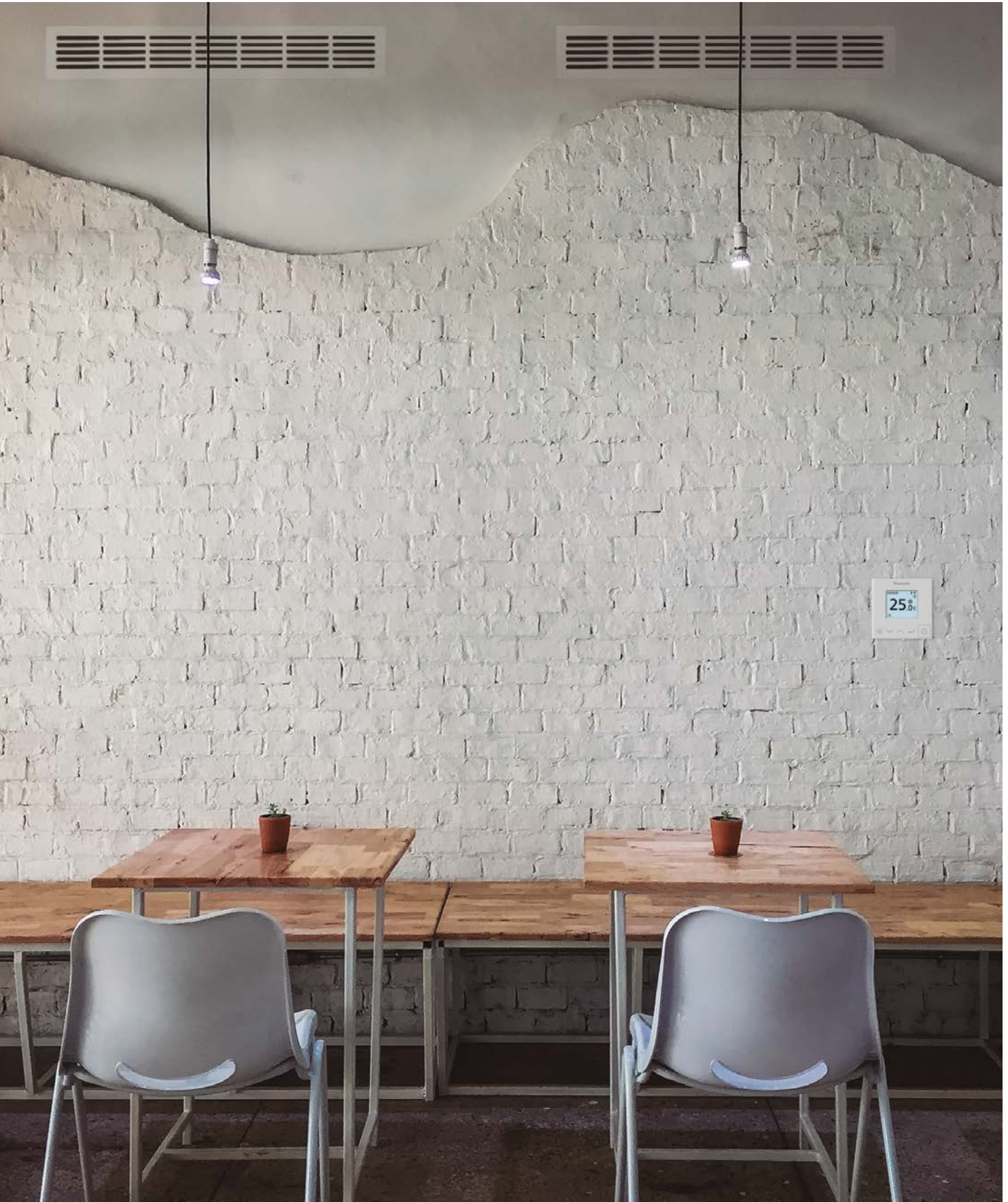



[+ SEE PRODUCT SPECIFICATIONS](#)

1 Highly flexible installation
2 installation possibilities (horizontal / vertical).

2 High seasonal performance with slim body
Maximum SEER: 7,4 A++¹⁾ / SCOP: 4,7 A++²⁾.
1) For 10,0 kW model. 2) For 7,1 kW model.

2 installation possibilities (horizontal / vertical)

Vertical installation is available. External static pressure 150 Pa, sufficient for remotely installing units away from the rooms.



3 Comfort operation
· Super Quiet operation, minimum 22 dB(A)*
· Optimized IAQ solutions for different target objectives. nanoe™ X and the new BION air pollutant filter (optional)

* 3,6 kW model and when operating with external static pressure 50 Pa in low fan mode.

Improved drain pan design

Just one drain pan for both horizontal and vertical installations. No need to modify the unit.

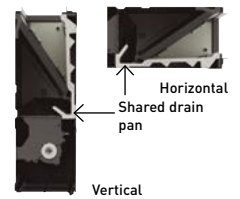

Selectable inlet air position

Inlet air position may be adjusted by means of a removable panel, to allow rear or bottom entry, depending on the duct installation.

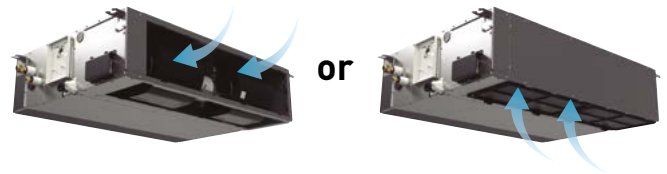

Maximum efficiency

Energy class ¹⁾ and seasonal efficiency value ($\eta_{s,c} / \eta_{s,h}$) ²⁾	kW	$\eta_{s,c} / \eta_{s,h}$					281,7%	275,9%
		3,6	5,0	6,0	7,1	10,0		
Elite		A++	A++	A++	A++	A++	170,0%	171,0%
		A+	A+	A++	A++	A+		
Standard		A+	A++	A++	A++	A++	257,4%	252,2%
		A+	A+	A++	A+	A		

1) Energy label scale from A+++ to D for models below 12,0 kW (EU regulation 626/2011). 2) $\eta_{s,c} / \eta_{s,h}$ values for models above 12,0 kW (EN 14825).

Compact body

· Only 250 mm high
· Light units from 25 to 39 kg

Conventional model	Adaptive ducted
33 kg	30 kg
290 mm	250 mm



Better indoor air quality with nanoe™ X

The performance of nanoe™ X technology is maintained, even with 10 m long ducts*. The effect of improved air quality is sufficient to allow for numerous duct shapes to fit the application.

* Panasonic internal survey.

As the experiments demonstrate, up to a duct length of 10 m, effectiveness of nanoe™ X is maintained even if the duct is bended 3 times.

nanoe™ X effect against odour proven in large space

In a room of 139 m², tobacco odour is reduced by a factor of 0,7 when compared to natural reduction over a period of 2 hours.

Tobacco deodorisation ratio.

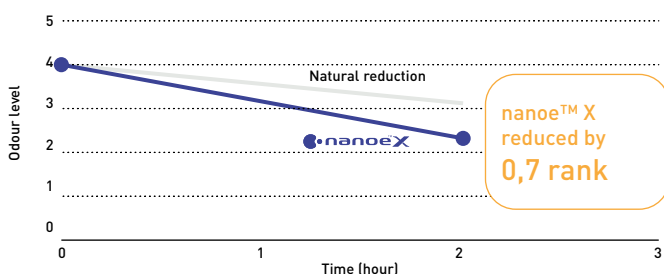

Test ambient.

3rd party international testing institute KAKEN¹⁾ conducted the performance experiment of Adaptive ducted equipped with nanoe X Generator Mark 2 device removing tobacco odour.

1) KAKEN TEST CENTER General Incorporated Foundation in Japan, international testing institute.

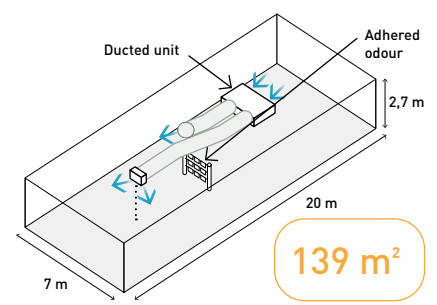

New BION air pollutant filter (optional)

Collaborating with BION, experts in filtration equipment, a new molecular filtration is available to improve indoor air quality.





The efficiency of nitrogen dioxide (NO₂) removal can reach 99,5%*

* Measured by ASTM6646 international standards. Efficiency reaches 99,5% within 4,8 seconds of contact time with the media bed (FAM filter). ** The performance varies depending on the room size, environment and usage and it may take several hours to reach the full effect. BION air pollutant filter is not medical device, local regulations on building design must be followed. Test results conducted under controlled laboratory conditions. Performance of BION air pollutant filter might differ in real life environment.

BION air pollutant filter traps and reduces certain types of harmful pollutant gases, listed below

- Nitrogen oxides (NO_x)
- Ozone (O₃)
- Sulfur dioxide (SO₂)
- Formaldehyde (HCHO)
- Volatile organic compounds (VOCs)

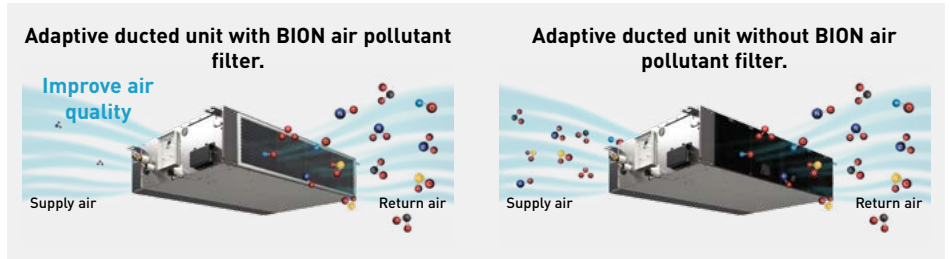

The BION air pollutant filter is an ideal solution for improving indoor air quality in urban areas.

Air pollution in urban areas in Europe

It is reported that in 2021, a significant portion of the Europe's urban population has been exposed to high levels of key air pollutants*.

- 75% of the urban population was exposed to NO₂ concentrations above 10 µg/m³
- 94% were exposed to concentrations of O₃ above 60 µg/m³

* The "Europe's Air Quality Status 2023" report (EEA, 2023) assesses levels of air pollutants measured in ambient air across Europe (> 2000 locations) for the years 2021 and 2022. It compares them against both EU standards as set out in the Ambient Air Quality Directives and the 2021 WHO Air Quality Guidelines.

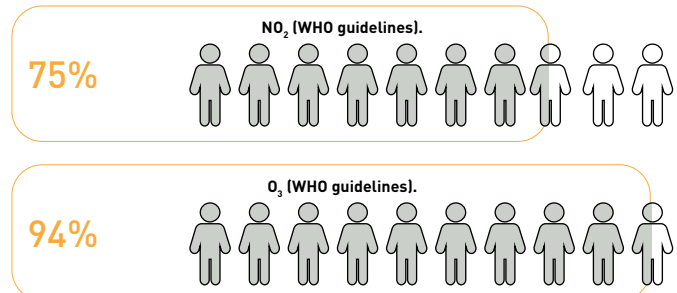

Share of the Europe's urban population exposed to air pollutant concentrations above EU standards and WHO guidelines in 2021, as referenced in the EEA 2023.

Why outdoor air pollution matters to IAQ?

Poor indoor air quality is associated with outdoor air pollutants such as car exhaust and factory fumes, and the two are closely linked. A significant portion of human exposure to air pollution occurs when they are indoors.



Different objectives, different IAQ solutions

In today's world, we are concerned about wellbeing and the air we breathe. And technology exists to ensure improved indoor air quality. With the introduction of the new BION air pollutant filter, Panasonic offers IAQ solutions optimized for various target objectives.

IAQ Solution	nanoe™ X	BION air pollutant filter
Objectives	Inhibit particles such as pollutants, certain types of viruses, and bacteria to clean and deodorise.	Inhibit gases such as nitrogen oxides (NO _x), ozone (O ₃), sulfur dioxide (SO ₂), formaldehyde (HCHO) and volatile organic compounds (VOCs)
Technology	Hydroxyl radicals contained in water	Molecular filtration
Filtering mechanism	Physical capture of particles	Adsorption and absorption
Availability	Built into all air-to-air indoor units as a standard	Optional accessory for the adaptive ducted unit (PF3/MF3)

BION air pollutant filter*	PAW-APF800F	PAW-APF1000F	PAW-APF1400F
Compatible adaptive ducted unit	S-3650PF3E	S-6071PF3E	S-1014PF3E

* The filter cartridge and filter casing are included in the package.

PACi NX wall-mounted, 4 way 60x60 cassette and ceiling



A new era of air conditioning solutions are here, with built-in nanoe™ X technology.



PACi NX wall-mounted - PK3.

Providing a small, lightweight and low noise level design, it is ideal for small offices and other commercial applications. It also has a stylish smooth design with a washable front panel.



Air distribution is automatically altered depending on the operational mode of the unit

Air outlet angle is automatically adjusted for cooling and heating operation.

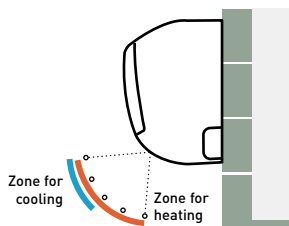
**Closed discharge port**

When the unit is turned OFF, the flap closes completely to prevent dust getting into the unit and to keep the equipment clean.

Piping outlet in six directions

Piping outlet is possible in six directions of; right, right rear, right bottom, left, left rear and left bottom, making the installation work more flexible.



+ SEE PRODUCT SPECIFICATIONS

PACi NX 4 way 60x60 cassette - PY3.

The PY3 not only perfectly matches with 600 x 600 mm ceiling grids but also provides an additional benefit for better indoor quality, with nanoe™ X built-in.

**Industry-leading energy efficiency**

- Energy class A++* with Elite outdoor range
- Energy class A++ with Standard outdoor range 2,5 kW model

* Except for 6,0 kW.

Internal cleaning function

When cooling or dry operation stopped, internal drying and nanoe™ X circulation airflow is activated in order to suppress the mould proliferation inside the unit (airflow passage, fan, heat exchanger)*.

* Depending on the installation environment or operating hours, mould proliferation or inhabitation of mould growth will be changed.

Compact and stylish design

- Required ceiling depth of only 250 mm
- Exposed area is only 30 mm

Individual flap control

Better control of the air flow with 4 motors, providing individual flap control. Perfect air distribution without direct airflow, to reduce the feeling of cold drafts.

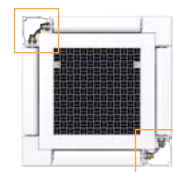

+ SEE PRODUCT SPECIFICATIONS

PACi NX ceiling - PT3.

Providing outstanding energy-saving performance, comfort and long-distance airflow distribution, these units are perfect for retail stores and schools.

**Comfortable, long-distance airflow distribution**

The shape of the outlet has been optimised to provide long-distance air flow distribution. Even in long rooms, air flow reaches every corner for exceptionally comfortable air conditioning.

* Results are based on specific testing conditions.

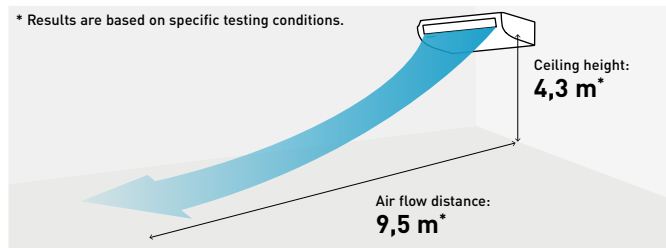
**Compact looking, stylish, one-motion design**

With its streamlined, one-motion form, the unit looks thin and compact when installed for a neat appearance in any room. When not operating, the louver closes to provide an elegant look while also keeping the unit clean.

Energy-saving technology delivering top-class efficiency

Optimisation of the shape of the casing and fan assures bigger air flow and higher efficiency. Energy-saving performance is top class in the industry. Thanks to new DC fan motor and large diagonal air flow fan.

+ SEE PRODUCT SPECIFICATIONS

High static pressure hide-away 20,0-25,0 kW - PE4, PE3

The split-able indoor unit design facilitates easy piping work. nanoe™ X technology* equipped as standard for improved indoor air quality.

* For models S-200PE4E and S-250PE4E.





+ SEE PRODUCT SPECIFICATIONS

1 Compact and light indoor body

Compact and light indoor body, keeping the high efficiency, has a split-able design for easy installation within a limited narrow space. Plus ease of maintenance due to the simplified disassembly design.

2 Easy pipe work with split-able hide-away indoor design

Heat exchanger and fan elements (fan + casing) can be separated during installation. The hide-away indoor unit is easily reassembled and will fit through a narrow space.

3 High external static pressure, maximum 200 Pa* setting

A high static pressure enables the use of long ducts for installation in a wide range of spaces.

* For models S-250PE4E and S-250PE3E5B.

4 Comfort operation

- nanoe™ X ¹⁾ as standard for improved indoor air quality.
- Smartphone control-ready with the Panasonic Comfort Cloud App ²⁾.

1) For models S-200PE4E and S-250PE4E. 2) Panasonic Wi-Fi Adaptor CZ-CAPWFC1 is required.

Improved indoor air quality with nanoe™ X

The nanoe™ X technology is now available for the Big PACi range from 20,0-25,0 kW.

The new PE4 model is equipped with Generator Mark 3, generating 48 trillion hydroxyl radicals/sec, specifically designed to accommodate long duct piping applications.



High static pressure hide-away line-up and the availability of nanoe™ X

	New PE4	PE3
20,0 kW	S-200PE4E	S-200PE3E5B
25,0 kW	S-250PE4E	S-250PE3E5B
nanoe™ X	Mark 3 as a standard	—

Maximum 200 Pa* static pressure setting

A high static pressure enables the use of long ducts for installation in a wide range of spaces.

3-step static pressure set up.

Selectable of static pressure modes can change 200 Pa / 130 Pa / 75 Pa for extra installation flexibility.

* For models S-250PE4E and S-250PE3E5B.



Easy installation with light components

Indoor unit can easily be split into 3 components, the heaviest of which weighs only 48 kg.

Dimensions of each component (lightweight design for easy disassembly).

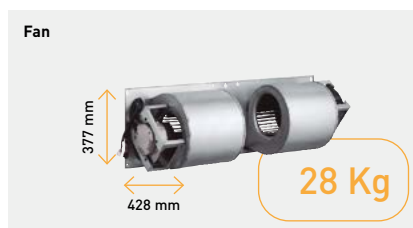

The weight is for S-250PE4E model.

Solutions for server rooms applications

Effectively protect your IT related spaces, 24/7, with a complete range of solutions offering redundancy control. High efficiency products provide reliable cooling all year round.



YKEA server room solution.

- Perfect solution for smaller server rooms
- Compact design
- Reaching SEER value of 9,6 (A+++)¹⁾
- High seasonal performance
- Range of capacities available
- Operation down to -25 °C ambient

¹⁾ For 3,5 kW unit.

PACi solution.

- Scalability for larger applications
- Twin, triple and double-twin options¹⁾
- Increased piping lengths of up to 90 m²⁾
- Increased sensible capacity options available
- Flexible and adaptable control options

¹⁾ Compatible with PAW-PACR4 only. ²⁾ For Big PACi 20 kW unit.

Redundancy ensured by three different functionalities.

Computer and server rooms are very sensitive areas of application. Any downtime caused by high room temperatures must be avoided by any means. Air conditioner redundancy is one of the key points to ensure a reliable nonstop cooling operation.

1 Backup operation

When an air conditioner fails for whatever reason, another one will awake from standby mode and cover the room's cooling load.

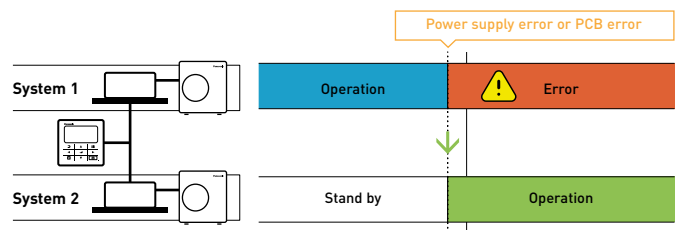

2 Support operation

Support operation, also called cascade control, makes sure that the capacity required to cool the room is delivered by one or more units whenever required. When the capacity of 1 air conditioner is not sufficient, another one will be started to support the operation.

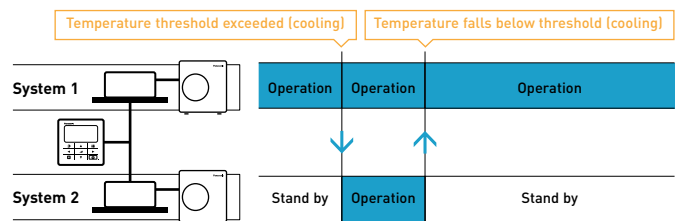

3 Rotation operation

Backup and support operation are key functions for a redundant operation in computer rooms. This concept implies a main system and a sub system. In order to avoid an imbalance of the operating hours of the systems, the redundancy control equalises the operation time by rotating the main and the sub systems, thus providing a "rotation operation".

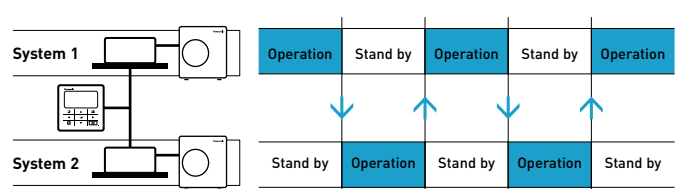

Redundancy control options for 24/7/365 applications

YKEA integral solution

- Ideal solution for small server rooms, providing full redundancy functionality integrated in YKEA's remote controller (requires optional CZ-RCC5 cable set)
- Up to 2 YKEA systems connectable to 1 remote controller
- Individual alarm display for each system
- Operation can be monitored by Panasonic Comfort Cloud App (via WLAN)
- No digital inputs/outputs

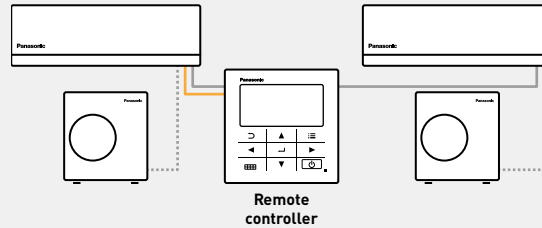

Optional interface for YKEA units

PAW-SERVER-PKEA

- Ideal solution for small server rooms, providing full redundancy functionality
- Up to 2 YKEA systems connectable to PAW-SERVER-PKEA
- Additional benefits: Operation and alarm outputs for each system, ON / OFF inputs for each system for connection to external BMS

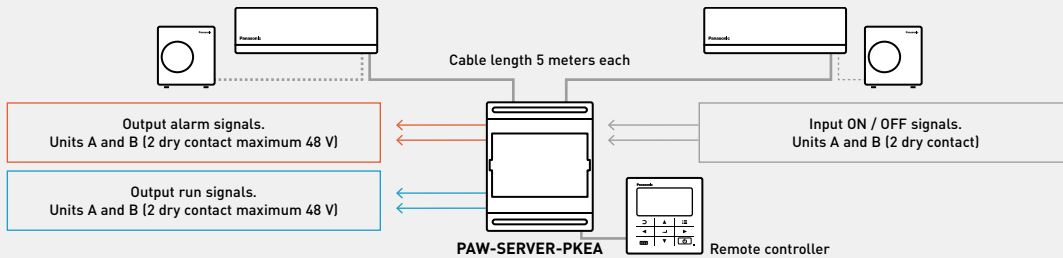

PACi integral solution

CZ-RTC5B / CZ-RTC6W / CZ-RTC6 / CZ-RTC6WBL / CZ-RTC6BL / CZ-RTC6WBLW / CZ-RTC6BLW

- Full redundancy functionality
- Quick and easy installation using PACi group control
- Up to 2 PACi systems connectable to 1 remote controller
- Delta T setting for support operation selectable from 4 to 10 K
- Connectable to Panasonic centralised control systems
- Optional interfaces for connection to external BMS (Modbus, BACnet, KNX)

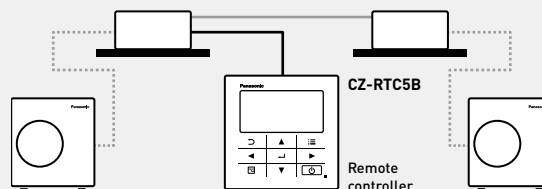







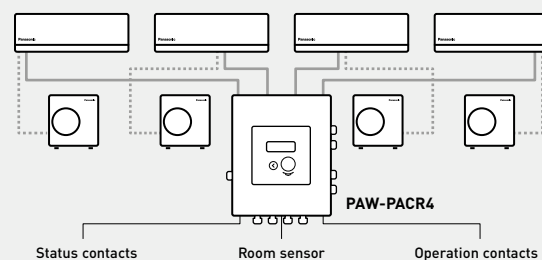





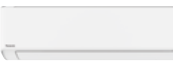

















Optional interface up to 4 indoor units PACi or VRF

PAW-PACR4

- Redundancy control up to 4 indoor unit groups
- Actual unit operation / alarm status can be displayed
- Common digital alarm / operation status output
- For each support operation level, individual temperature thresholds can be set (cascade control)
- Room temperature display (by device's own temperature sensor)
- Modbus connection (up to 4 PAW-RC2-MBS-1)
- Available external inputs (ON / OFF, heating/cooling change, fire prevention contact)



Commercial units range

Page	Indoor units	2,5 kW	3,6 kW	4,5 kW ¹⁾	5,0 kW	6,0 kW
P. 182	Wall-mounted Professional · R32 ²⁾	 CS-Z25YKEA	 CS-Z35YKEA	 CS-Z42YKEA	 CS-Z50YKEA	
P. 184	PACi NX wall-mounted · R32		 S-3650PK3E	 S-3650PK3E	 S-3650PK3E	 S-6010PK3E
P. 188	PACi NX 4 way 60x60 cassette · R32	 S-25PY3E	 S-36PY3E		 S-50PY3E	 S-60PY3E
P. 190	PACi NX 4 way 90x90 cassette · R32		 S-3650PU3E	 S-3650PU3E	 S-3650PU3E	 S-6071PU3E
P. 194	PACi NX ceiling · R32		 S-3650PT3E	 S-3650PT3E	 S-3650PT3E	 S-6071PT3E
P. 198	PACi NX adaptive ducted · R32		 S-3650PF3E	 S-3650PF3E	 S-3650PF3E	 S-6071PF3E
P. 202	NEW Big PACi NX high static pressure hide-away 20-25 kW					
P. 203	Big PACi high static pressure hide-away 20-25 kW					
Outdoor units	2,5 kW	3,6 kW		5,0 kW	6,0 kW	
PACi NX Elite Big PACi NX (20-25 kW)		 U-36PZH3E5		 U-50PZH3E5	 U-60PZH3E5	
PACi NX Standard	 U-25PZ3E5	 U-36PZ3E5		 U-50PZ3E5	 U-60PZ3E5A	

Big PACi

1) The 4,5 kW indoor capacity options are only available only for twin, triple and double-twin combinations. 2) Not compatible with PACi NX outdoors and accessories. Domestic range sales conditions may apply. Check with your sales representative. 3) These two units are not in PACi NX range but part of Big PACi range.
* U-__E5 Single phase / U-__E8 Three phase.

+ OPTIONAL UNITS ON VENTILATION SECTION

7,1 kW

10,0 kW

12,5 kW

14,0 kW

20,0 kW

25,0 kW

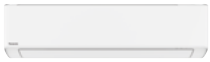

CS-Z71YKEA



S-6010PK3E



S-6010PK3E



S-6071PU3E



S-1014PU3E



S-1014PU3E



S-1014PU3E



S-6071PT3E



S-1014PT3E



S-1014PT3E



S-1014PT3E



S-6071PF3E



S-1014PF3E



S-1014PF3E



S-1014PF3E



S-200PE4E



S-250PE4E



S-200PE3E5B



S-250PE3E5B

7,1 kW

10,0 kW

12,5 kW

14,0 kW

20,0 kW

25,0 kW



U-71PZH4E5 / U-71PZH4E8



U-100PZH4E5 / U-100PZH4E8



U-125PZH4E5 / U-125PZH4E8



U-140PZH4E5 / U-140PZH4E8



U-200PZH4E8



U-250PZH4E8



U-71PZ3E5A



U-100PZ3E5 / U-100PZ3E8



U-125PZ3E5 / U-125PZ3E8



U-140PZ3E5 / U-140PZ3E8



U-200PZH2E8 ³¹



U-250PZH2E8 ³¹

YKEA series for server rooms

High efficiency products for 24/7 applications. Panasonic has developed a complete range of solutions for server rooms which efficiently protect your servers, keeping them at an appropriate temperature even when the outdoor temperature is below -25 °C.



1 Designed for 24h/7d a week operation

High efficiency all year round. This wall-mounted air conditioner is designed for professional, critical applications such as computer rooms where reliable cooling inside the room is necessary even with extreme ambient conditions.

3 Highest energy rating in cooling

The SEER and SCOP of the Server room unit has been further improved to achieve top class energy efficiency. The 3,5 kW unit reaches now the SEER value of 9,6 (A+++).

2 Remote controller for better usability

Wired remote controller, which can assure the operation 24/7 of two server room units, thanks to the integrated duty rotation mode. This function manages rotation and backup of two units and it is available when connecting an optional CN-CNT cable (CZ-RCC5) between the controller and each of the two indoor units.

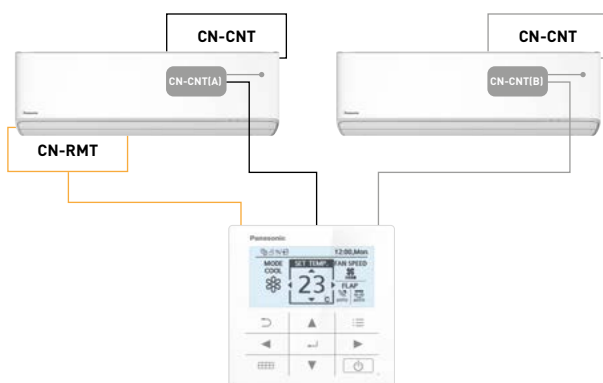

4 Built-in Wi-Fi and compatible with Voice Assistant

The unit is ready to connect to the internet and to be controlled by smartphone with Panasonic Comfort Cloud App. Control, monitor energy consumption statistics and easily identify errors in case of failure.

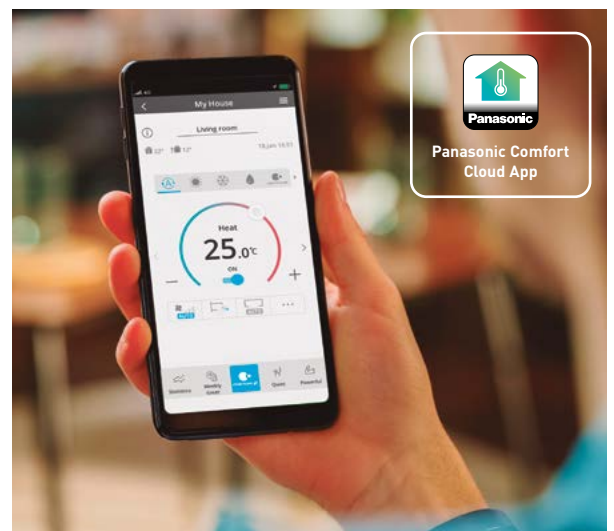

Not compatible with PACi NX outdoors and accessories. Domestic range sales conditions may apply. Check with your sales representative.

Wall-mounted Professional -25 °C · R32

- Designed for 24h/7d a week operation
- Wired remote controller, with optional duty rotation mode
- Improved SEER / SCOP to achieve top class energy efficiency
- Aerowings 2.0, for a better control of the airflow
- Built-in Wi-Fi for smart control via Panasonic Comfort Cloud App
- Compatible with Google Assistant and Amazon Alexa
- Chassis and parts designed for easier installation



Kit			KIT-Z25-YKEA	KIT-Z35-YKEA	KIT-Z42-YKEA	KIT-Z50-YKEA	KIT-Z71-YKEA
Cooling capacity	Nominal (Min - Max)	kW	2,50 (0,85 - 3,50)	3,50 (0,85 - 4,20)	4,20 (0,85 - 5,00)	5,00 (0,98 - 6,00)	7,10 (0,98 - 8,50)
EER ¹⁾	Nominal (Min - Max)	W/W	4,90 (4,72 - 3,98)	4,12 (4,72 - 3,68)	3,82 (4,72 - 3,25)	3,68 (3,92 - 3,16)	3,23 (2,33 - 2,83)
SEER ²⁾			9,5 A+++	9,6 A+++	8,6 A+++	8,6 A+++	6,5 A++
Pdesign		kW	2,50	3,50	4,20	5,00	7,10
Input power	Nominal (Min - Max)	kW	0,51 (0,18 - 0,88)	0,85 (0,18 - 1,14)	1,10 (0,18 - 1,54)	1,36 (0,25 - 1,90)	2,20 (0,42 - 3,00)
Annual energy consumption ³⁾		kWh/a	92	128	171	203	382
Heating capacity	Nominal (Min - Max)	kW	3,40 (0,85 - 5,00)	4,00 (0,85 - 5,80)	5,30 (0,85 - 6,80)	5,80 (0,98 - 8,00)	8,20 (0,98 - 10,20)
Heating capacity at -7 °C		kW	3,05	3,40	4,11	4,80	6,31
COP ¹⁾	Nominal (Min - Max)	W/W	4,86 (4,72 - 3,97)	4,44 (4,72 - 3,87)	3,93 (4,72 - 3,66)	4,08 (4,26 - 3,35)	3,71 (2,45 - 3,29)
SCOP ²⁾			4,6 A++	4,6 A++	4,5 A+	4,6 A++	4,1 A+
Pdesign at -10 °C		kW	2,70	3,20	3,60	4,20	5,50
Input power	Nominal (Min - Max)	kW	0,70 (0,18 - 1,26)	0,90 (0,18 - 1,50)	1,35 (0,18 - 1,86)	1,42 (0,23 - 2,39)	2,21 (0,40 - 3,10)
Annual energy consumption ³⁾		kWh/a	822	974	1120	1278	1878
Indoor unit			CS-Z25YKEA	CS-Z35YKEA	CS-Z42YKEA	CS-Z50YKEA	CS-Z71YKEA
Power supply		V	230	230	230	230	230
Recommended fuse		A	16	16	16	16	20
Connection indoor / outdoor		mm ²	4x1,5	4x1,5	4x1,5	4x2,5	4x2,5
Air flow	Cool / Heat	m ³ /min	11,4/13,8	12,7/14,8	13,2/15,2	17,4/19,1	19,0/19,9
Moisture removal volume		L/h	1,5	2,0	2,4	2,8	4,1
Sound pressure ⁴⁾	Cool (Hi / Lo / Q-Lo)	dB(A)	39/25/21	42/28/21	43/32/29	44/37/30	47/38/35
	Heat (Hi / Lo / Q-Lo)	dB(A)	41/27/22	43/30/22	44/35/29	44/37/30	47/38/35
Sound power	Cool / Heat (Hi)	dB(A)	55/57	58/59	59/60	60/60	63/63
Dimension	H x W x D	mm	295 x 870 x 229	295 x 870 x 229	295 x 870 x 229	295 x 1040 x 244	295 x 1040 x 244
Net weight		kg	11	11	11	12	13
Outdoor unit			CU-Z25YKEA	CU-Z35YKEA	CU-Z42YKEA	CU-Z50YKEA	CU-Z71YKEA
Air flow	Cool / Heat	m ³ /min	27,6/27,6	29,8/29,8	29,8/31,0	39,8/36,9	44,7/45,8
Sound pressure ⁴⁾	Cool / Heat (Hi)	dB(A)	46/48	48/50	48/51	48/50	52/54
Sound power	Cool / Heat (Hi)	dB(A)	61/63	63/65	63/66	63/65	66/68
Dimension ⁵⁾	H x W x D	mm	542 x 780 x 289	542 x 780 x 289	542 x 780 x 289	695 x 875 x 320	695 x 875 x 320
Net weight		kg	30	30	30	40	45
Piping diameter	Liquid	Inch (mm)	1/4 (6,35)	1/4 (6,35)	1/4 (6,35)	1/4 (6,35)	1/4 (6,35)
	Gas	Inch (mm)	3/8 (9,52)	3/8 (9,52)	1/2 (12,70)	1/2 (12,70)	5/8 (15,88)
Pipe length range		m	3 - 20	3 - 20	3 - 20	3 - 30	3 - 30
Elevation difference (in / out)		m	15	15	15	15	20
Pre-charged pipe length		m	7,5	7,5	7,5	7,5	10
Additional gas amount		g/m	10	10	10	15	25
Refrigerant (R32) / CO ₂ Eq.		kg / T	0,89/0,60	0,89/0,60	0,97/0,65	1,13/0,76	1,35/0,91
Operating range	Cool Min ~ Max	°C	-25 ~ +43	-25 ~ +43	-25 ~ +43	-25 ~ +43	-25 ~ +43
	Heat Min ~ Max	°C	-15 ~ +24	-15 ~ +24	-15 ~ +24	-15 ~ +24	-15 ~ +24

1) EER and COP calculation is based in accordance to EN14511. 2) Energy Label Scale from A+++ to D. 3) The annual energy consumption is calculated in accordance to EU/626/2011. 4) The sound pressure of the indoor unit shows the value measured at a position 1 m in front of the main body and 0,8 m below the unit. For outdoor unit 1 m in front and 1 m in rear side of main body. The sound pressure is measured in accordance with JIS C 9612. Q-Lo: Quiet mode. Lo: The lowest set fan speed. 5) Add 70 mm for piping port. * Not compatible with PACI NX outdoors and accessories. Domestic range sales conditions may apply. Check with your sales representative.

Accessories	
CZ-RCC5	CN-CNT cables x2 for server room application, control of 2 units, rotation, backup, etc.
PAW-WTRAY	Tray for condenser water compatible with outdoor elevation platform

Accessories	
PAW-GRDBSE20	Outdoor base ground support for noise and vibration absorption
PAW-GRDSTD40	Outdoor elevation platform 400x900x400 mm

R32

9,6 SEER

4,6 SCOP

INVERTER

R2 ROTARY COMPRESSOR

21 dB(A)

AEROWINGS

-25 °C COOLING MODE

-15 °C HEATING MODE

R32 R410A R32 R410A RENEWAL

INTEGRATION TO S-LINK

BUILT-IN WI-FI

BMS CONNECTIVITY

5 YEARS COMPRESSOR WARRANTY

SEER: For KIT-Z35-YKEA. SCOP: For KIT-Z25-YKEA, KIT-Z35-YKEA and KIT-Z50-YKEA. SUPER QUIET: For KIT-Z25-YKEA. INTERNET CONTROL: Built-in Wi-Fi.

Rating conditions: Cooling indoor 27 °C DB / 19 °C WB. Cooling outdoor 35 °C DB / 24 °C WB. Heating indoor 20 °C DB. Heating outdoor 7 °C DB / 6 °C WB. (DB: Dry Bulb; WB: Wet Bulb). Specifications subject to change without notice. For detailed information about ErP / Energy Labelling, please visit our websites www.aircon.panasonic.eu or www.ptc.panasonic.eu.

PACi NX Series Elite wall-mounted - PK3 - R32

The wall-mounted units with stylish matt color can be offered for many applications such as studios, gyms, high ceiling areas and even computer server rooms.

The compact design and flat face ensure discreet installation, even in a small space.



			Single phase				
			3,6 kW	5,0 kW	6,0 kW	7,1 kW	10,0 kW
Kit			KIT-36PK3ZH5	KIT-50PK3ZH5	KIT-60PK3ZH5	KIT-71PK3ZH45	KIT-100PK3ZH45
Remote controller			CZ-RTC5B	CZ-RTC5B	CZ-RTC5B	CZ-RTC5B	CZ-RTC5B
Cooling capacity	Nominal (Min - Max)	kW	3,6 [1,2 - 4,0]	5,0 [1,2 - 5,6]	6,1 [1,2 - 7,1]	7,1 [2,2 - 9,0]	9,5 [3,1 - 10,5]
EER ¹⁾	Nominal (Min - Max)	W/W	4,93 [4,49 - 5,45]	4,24 [3,61 - 5,45]	3,86 [3,02 - 5,45]	3,50 [2,69 - 5,79]	3,21 [3,09 - 5,34]
SEER ²⁾			8,4 A++	8,0 A++	7,2 A++	6,8 A++	6,4 A++
Pdesign		kW	3,6	5,0	6,1	7,1	9,5
Input power	Nominal (Min - Max)	kW	0,73 [0,22 - 0,89]	1,18 [0,22 - 1,55]	1,58 [0,22 - 2,35]	2,03 [0,38 - 3,35]	2,96 [0,58 - 3,40]
Annual energy consumption ³⁾		kWh/a	150	219	297	365	520
Heating capacity	Nominal (Min - Max)	kW	4,0 [1,2 - 5,0]	5,6 [1,2 - 6,5]	7,0 [1,2 - 8,0]	8,0 [2,0 - 9,0]	9,5 [3,1 - 11,5]
COP ¹⁾	Nominal (Min - Max)	W/W	4,82 [4,17 - 5,45]	4,15 [3,55 - 5,45]	4,19 [3,40 - 5,45]	4,00 [3,16 - 5,56]	3,88 [3,43 - 5,54]
SCOP ²⁾			4,9 A++	4,7 A++	4,8 A++	4,7 A++	3,9 A
Pdesign at -10 °C		kW	3,6	4,5	4,6	5,2	8,0
Input power	Nominal (Min - Max)	kW	0,83 [0,22 - 1,20]	1,35 [0,22 - 1,83]	1,67 [0,22 - 2,35]	2,00 [0,36 - 2,85]	2,45 [0,56 - 3,35]
Annual energy consumption ³⁾		kWh/a	1029	1341	1342	1549	2871
Indoor unit			S-3650PK3E	S-3650PK3E	S-6010PK3E	S-6010PK3E	S-6010PK3E
Air flow	Hi / Med / Lo	m ³ /min	13,0/11,0/9,0	16,0/13,5/11,0	20,0/17,5/14,5	20,0/17,5/14,5	22,0/18,5/15,5
Moisture removal volume		L/h	0,9	1,8	2,0	3,0	4,8
Sound pressure ⁴⁾	Hi / Med / Lo	dB(A)	35/31/27	40/36/32	47/44/40	47/44/40	49/45/41
Sound power	Hi / Med / Lo	dB(A)	51/47/43	56/52/48	63/60/56	63/60/56	65/61/57
Dimension	H x W x D	mm	302 x 1120 x 236	302 x 1120 x 236	302 x 1120 x 236	302 x 1120 x 236	302 x 1120 x 236
Net weight		kg	13	13	14	14	14
nanoe X Generator			Mark 2	Mark 2	Mark 2	Mark 2	Mark 2
Outdoor unit			U-36PZH3E5	U-50PZH3E5	U-60PZH3E5	U-71PZH4E5	U-100PZH4E5
Power supply		V	220 - 230 - 240	220 - 230 - 240	220 - 230 - 240	220 - 230 - 240	220 - 230 - 240
Current	Cool	A	3,60 - 3,45 - 3,30	5,60 - 5,35 - 5,10	7,40 - 7,10 - 6,80	10,3 - 9,80 - 9,40	14,60 - 14,00 - 13,40
	Heat	A	4,05 - 3,90 - 3,70	6,40 - 6,10 - 5,85	7,75 - 7,40 - 7,10	10,10 - 9,65 - 9,25	12,00 - 11,60 - 11,10
Air flow	Cool / Heat	m ³ /min	34,1/36,4	42,0/42,0	42,0/42,0	62,0/66,0	76,0/70,0
Sound pressure	Cool / Heat (Hi)	dB(A)	43/44	46/48	47/50	48/50	52/52
Sound power	Cool / Heat (Hi)	dB(A)	62/64	64/67	65/69	65/67	69/69
Dimension	H x W x D	mm	695 x 875 x 320	695 x 875 x 320	695 x 875 x 320	996 x 980 x 370	996 x 980 x 370
Net weight		kg	42	42	43	66	84
Piping diameter	Liquid	Inch (mm)	1/4 [6,35]	1/4 [6,35]	1/4 [6,35] ⁵⁾	3/8 [9,52]	3/8 [9,52]
	Gas	Inch (mm)	1/2 [12,70]	1/2 [12,70]	1/2 [12,70] ⁶⁾	5/8 [15,88]	5/8 [15,88]
Pipe length range		m	3 - 40	3 - 40	3 - 40	5 - 60	5 - 100
Elevation difference (in / out) ⁷⁾		m	15/30	15/30	15/30	15/30	15/30
Pre-charged pipe length		m	30	30	30	30	30
Additional gas amount		g/m	15	15	15	30	40
Refrigerant (R32) / CO ₂ Eq.		kg / T	1,13/0,76	1,13/0,76	1,15/0,78	1,95/1,32	2,70/1,82
Operating range	Cool Min ~ Max	°C	-15 ~ +46	-15 ~ +46	-15 ~ +46	-15 ~ +52	-20 ⁸⁾ ~ +52
	Heat Min ~ Max	°C	-20 ~ +24	-20 ~ +24	-20 ~ +24	-20 ~ +24	-20 ~ +24

Technical focus

- Modern design with flat face and compact size
- DC fan for better efficiency and control
- Six directional piping outlet
- nanoe™ X (Generator Mark 2: 9,6 trillion hydroxyl radicals/sec) as standard for better indoor air quality
- Wired remote control CZ-RTC6WBL and CZ-RTC6BL allows easy system setting via Bluetooth®
- Easy connection and control of external fan or ERV using the connector PAW-FDC on the indoor unit PCB. The external device can be controlled by the remote control of the Panasonic indoor unit

Closed discharge port

When the unit is turned OFF, the flap closes completely to prevent dust getting into the unit and to keep the equipment clean.

Quiet operation

These units are among the quietest in the industry, making them ideal for hotels and hospitals.

Piping outlet in six directions

Piping outlet is possible in six directions of; right, right rear, right bottom, left, left rear and left bottom, making the installation work more flexible.

COMPATIBLE WITH ALL PANASONIC CONNECTIVITY SOLUTIONS. FOR DETAILED INFORMATION GO TO THE CONTROL SYSTEMS SECTION



CZ-RTC5B



Optional:

CONEX



CONEX wired remote controller, white. CZ-RTC6W/BL/BLW

CONEX



CONEX wired remote controller, black. CZ-RTC6/BL/BLW



Infrared remote controller. CZ-RWS3



Econavi sensor. CZ-CENSC1

Three phase

			7,1 kW	10,0 kW
Kit			KIT-71PK3ZH48	KIT-100PK3ZH48
Remote controller			CZ-RTC5B	CZ-RTC5B
Cooling capacity	Nominal (Min - Max)	kW	7,1 (2,2 - 9,0)	9,5 (3,1 - 10,5)
EER ¹⁾	Nominal (Min - Max)	W/W	3,50 (2,69 - 5,79)	3,21 (3,09 - 5,34)
SEER ²⁾			6,7 A++	6,3 A++
Pdesign		kW	7,1	9,5
Input power	Nominal (Min - Max)	kW	2,03 (0,38 - 3,35)	2,96 (0,58 - 3,40)
Annual energy consumption ³⁾		kWh/a	370	526
Heating capacity	Nominal (Min - Max)	kW	8,0 (2,0 - 9,0)	9,5 (3,1 - 11,5)
COP ¹⁾	Nominal (Min - Max)	W/W	4,00 (3,16 - 5,56)	3,88 (3,43 - 5,54)
SCOP ²⁾			4,7 A++	3,9 A
Pdesign at -10 °C		kW	5,2	8,0
Input power	Nominal (Min - Max)	kW	2,00 (0,36 - 2,85)	2,45 (0,56 - 3,35)
Annual energy consumption ³⁾		kWh/a	1549	2871
Indoor unit			S-6010PK3E	S-6010PK3E
Air flow	Hi / Med / Lo	m ³ /min	20,0/17,5/14,5	22,0/18,5/15,0
Moisture removal volume		L/h	3,0	4,8
Sound pressure ⁴⁾	Hi / Med / Lo	dB(A)	47/44/40	49/45/41
Sound power	Hi / Med / Lo	dB(A)	63/60/56	65/61/57
Dimension	HxWxD	mm	302x1120x236	302x1120x236
Net weight		kg	14	14
nanoe X Generator			Mark 2	Mark 2
Outdoor unit			U-71PZH4E8	U-100PZH4E8
Power supply		V	380-400-415	380-400-415
Current	Cool	A	3,45-3,25-3,15	4,95-4,70-4,50
	Heat	A	3,40-3,20-3,10	4,10-3,90-3,70
Air flow	Cool / Heat	m ³ /min	62,0/66,0	76,0/70,0
Sound pressure	Cool / Heat (Hi)	dB(A)	48/50	52/52
Sound power	Cool / Heat (Hi)	dB(A)	65/67	69/69
Dimension	HxWxD	mm	996x980x370	996x980x370
Net weight		kg	66	82
Piping diameter	Liquid	Inch (mm)	3/8 (9,52)	3/8 (9,52)
	Gas	Inch (mm)	5/8 (15,88)	5/8 (15,88)
Pipe length range		m	5-60	5-100
Elevation difference (in / out) ⁷⁾		m	15/30	15/30
Pre-charged pipe length		m	30	30
Additional gas amount		g/m	30	40
Refrigerant (R32) / CO ₂ Eq.		kg / T	1,95/1,32	2,70/1,82
Operating range	Cool Min ~ Max	°C	-15 ~ +52	-20 ⁸⁾ ~ +52
	Heat Min ~ Max	°C	-20 ~ +24	-20 ~ +24

1) EER and COP calculation is based in accordance to EN14511. 2) For models below 12 kW, the SEER and SCOP is calculated based on values of EU/626/2011. For models above 12 kW, the $\eta_{s,c} / \eta_{s,h}$ values is calculated based on EN 14825. 3) Factory setting. 4) The sound pressure of the units shows the value measured of the position 1 m in front of the main body and 1 m below the unit. The sound pressure is measured in accordance with Eurovent 6/C/006-97 specification. 5) Connect the liquid socket tube (Ø6,35-Ø9,52) to the liquid tubing side indoor unit. 6) Connect the gas socket tube (Ø12,70-Ø15,88) to the gas tubing side indoor unit. 7) Outdoor unit located lower / outdoor unit located higher. 8) Pipe length up to 30 m. * Recommended fuse for the indoor 3 A. ** Above values are in the case of nanoe™ X OFF.

Accessories

CZ-RTC6W	CONEX wired remote controller (non-wireless), white
CZ-RTC6WBL	CONEX wired remote controller with Bluetooth®, white
CZ-RTC6WBLW	CONEX wired remote controller with Wi-Fi and Bluetooth®, white
CZ-RTC6	CONEX wired remote controller (non-wireless), black
CZ-RTC6BL	CONEX wired remote controller with Bluetooth®, black
CZ-RTC6BLW	CONEX wired remote controller with Wi-Fi and Bluetooth®, black
CZ-RTC5B	Wired remote controller with Econavi function and datanavi
CZ-RWS3	Infrared remote controller

Accessories

CZ-CAPWFC1	Commercial Wi-Fi Adaptor
PAW-PACR4	Interface to run up to 4 indoor unit groups on backup and alternative run
PAW-WTRAY	Tray for condenser water compatible with outdoor elevation platform
PAW-GRDBSE20	Outdoor base ground support for noise and vibration absorption
PAW-GRDSTD40	Outdoor elevation platform 400x900x400 mm
CZ-CENSC1	Econavi energy saving sensor



SEER and SCOP: For S-3650PK3E + U-36PZH3E5. INTERNET CONTROL: Optional.

Rating conditions: Cooling indoor 27 °C DB / 19 °C WB. Cooling outdoor 35 °C DB / 24 °C WB. Heating indoor 20 °C DB. Heating outdoor 7 °C DB / 6 °C WB. (DB: Dry Bulb; WB: Wet Bulb). Specifications subject to change without notice. For detailed information about ErP / Energy Labelling, please visit our websites www.aircon.panasonic.eu or www.ptc.panasonic.eu.

PACi NX Series Standard wall-mounted - PK3 · R32

The wall-mounted units with stylish matt color can be offered for many applications such as studios, gyms, high ceiling areas and even computer server rooms.

The compact design and flat face ensure discreet installation, even in a small space.



			Single phase				
			3,6 kW	5,0 kW	6,0 kW	7,1 kW	10,0 kW
Kit			KIT-36PK3Z5	KIT-50PK3Z5	KIT-60PK3Z5	KIT-71PK3Z5	KIT-100PK3Z5
Remote controller			CZ-RTC5B	CZ-RTC5B	CZ-RTC5B	CZ-RTC5B	CZ-RTC5B
Cooling capacity	Nominal (Min - Max)	kW	3,6(1,5 - 4,0)	5,0(1,5 - 5,6)	6,1(2,0 - 7,1)	7,1(2,6 - 7,7)	9,0(3,0 - 9,7)
EER ¹⁾	Nominal (Min - Max)	W/W	4,14(3,74 - 5,88)	3,52(3,03 - 6,25)	3,67(3,01 - 6,90)	3,16(2,77 - 5,00)	3,47(3,13 - 5,36)
SEER ²⁾			7,6 A++	7,4 A++	7,0 A++	5,8 A+	6,5 A++
Pdesign		kW	3,6	5,0	6,1	7,1	9,0
Input power	Nominal (Min - Max)	kW	0,87(0,26 - 1,07)	1,42(0,24 - 1,85)	1,66(0,29 - 2,36)	2,25(0,52 - 2,78)	2,59(0,56 - 3,10)
Annual energy consumption ³⁾		kWh/a	166	237	3,05	429	485
Heating capacity	Nominal (Min - Max)	kW	3,6(1,5 - 4,6)	5,0(1,5 - 6,4)	6,1(1,8 - 7,0)	7,1(2,1 - 8,1)	9,0(3,0 - 10,5)
COP ¹⁾	Nominal (Min - Max)	W/W	4,62(4,11 - 6,52)	4,20(3,17 - 7,50)	4,39(3,18 - 7,50)	4,23(3,38 - 6,36)	3,93(3,56 - 5,36)
SCOP ²⁾			4,5 A+	4,4 A+	4,7 A++	4,4 A+	3,9 A
Pdesign at -10 °C		kW	2,8	4,0	4,6	5,2	9,0
Input power	Nominal (Min - Max)	kW	0,78(0,23 - 1,12)	1,19(0,20 - 2,02)	1,39(0,24 - 2,20)	1,68(0,33 - 2,40)	2,29(0,56 - 2,95)
Annual energy consumption ³⁾		kWh/a	872	1273	1370	1653	3231
Indoor unit			S-3650PK3E	S-3650PK3E	S-6010PK3E	S-6010PK3E	S-6010PK3E
Air flow	Hi / Med / Lo	m ³ /min	13,0/11,0/9,0	16,0/13,5/11,0	20,0/17,5/14,5	20,0/17,5/14,5	22,0/18,5/15,0
Moisture removal volume		L/h	0,9	1,8	2,0	3,0	4,3
Sound pressure ⁴⁾	Hi / Med / Lo	dB(A)	35/31/27	40/36/32	47/44/40	47/44/40	49/45/41
Sound power	Hi / Med / Lo	dB(A)	51/47/43	56/52/48	63/60/56	63/60/56	65/61/57
Dimension	H x W x D	mm	302 x 1120 x 236	302 x 1120 x 236	302 x 1120 x 236	302 x 1120 x 236	302 x 1120 x 236
Net weight		kg	13	13	14	14	14
nanoe X Generator			Mark 2	Mark 2	Mark 2	Mark 2	Mark 2
Outdoor unit			U-36PZ3E5	U-50PZ3E5	U-60PZ3E5A	U-71PZ3E5A	U-100PZ3E5
Power supply		V	220 - 230 - 240	220 - 230 - 240	220 - 230 - 240	220 - 230 - 240	220 - 230 - 240
Current	Cool	A	4,05 - 3,85 - 3,70	6,60 - 6,30 - 6,05	7,70 - 7,35 - 7,05	10,4 - 10,00 - 9,55	12,9 - 12,4 - 11,9
	Heat	A	3,65 - 3,50 - 3,35	5,60 - 5,35 - 5,10	6,45 - 6,15 - 5,90	7,80 - 7,45 - 7,15	11,4 - 10,9 - 10,5
Air flow	Cool / Heat	m ³ /min	33,6/34,0	32,7/31,9	42,6/41,5	44,7/45,9	73,0/73,0
Sound pressure	Cool / Heat (Hi)	dB(A)	46/47	46/46	47/48	48/49	52/52
Sound power	Cool / Heat (Hi)	dB(A)	64/66	64/64	64/65	66/68	70/70
Dimension	H x W x D	mm	619 x 824 x 299	619 x 824 x 299	695 x 875 x 320	695 x 875 x 320	996 x 980 x 370
Net weight		kg	32	35	42	50	83
Piping diameter	Liquid	Inch (mm)	1/4 (6,35)	1/4 (6,35)	1/4 (6,35) ⁵⁾	1/4 (6,35) ⁵⁾	3/8(9,52)
	Gas	Inch (mm)	1/2(12,70)	1/2(12,70)	1/2(12,70) ⁶⁾	5/8(15,88) ⁶⁾	5/8(15,88)
Pipe length range		m	3 - 15	3 - 20	3 - 40	3 - 40	5 - 50
Elevation difference (in / out) ⁷⁾		m	15/15	15/15	15/30	20/30	15/30
Pre-charged pipe length		m	7,5	7,5	30	30	30
Additional gas amount		g/m	10	15	15	17	45
Refrigerant (R32) / CO ₂ Eq.		kg / T	0,87/0,59	1,14/0,77	1,15/0,78	1,32/0,89	2,4/1,62
Operating range	Cool Min ~ Max	°C	-10 ~ +43	-10 ~ +43	-10 ~ +43	-10 ~ +43	-10 ~ +43
	Heat Min ~ Max	°C	-15 ~ +24	-15 ~ +24	-15 ~ +24	-15 ~ +24	-15 ~ +24

Technical focus

- Modern design with flat face and compact size
- DC fan for better efficiency and control
- Six directional piping outlet
- nanoe™ X (Generator Mark 2: 9,6 trillion hydroxyl radicals/sec) as standard for better indoor air quality
- Wired remote control CZ-RTC6WBL and CZ-RTC6BL allows easy system setting via Bluetooth®
- Easy connection and control of external fan or ERV using the connector PAW-FDC on the indoor unit PCB. The external device can be controlled by the remote control of the Panasonic indoor unit

Closed discharge port

When the unit is turned OFF, the flap closes completely to prevent dust getting into the unit and to keep the equipment clean.

Quiet operation

These units are among the quietest in the industry, making them ideal for hotels and hospitals.

Piping outlet in six directions

Piping outlet is possible in six directions of; right, right rear, right bottom, left, left rear and left bottom, making the installation work more flexible.



CZ-RTC5B

COMPATIBLE WITH ALL PANASONIC CONNECTIVITY SOLUTIONS. FOR DETAILED INFORMATION GO TO THE CONTROL SYSTEMS SECTION

Optional:



CONEX wired remote controller, white. CZ-RTC6W/BL/BLW



CONEX wired remote controller, black. CZ-RTC6/BL/BLW



Infrared remote controller. CZ-RWS3



Econavi sensor. CZ-CENSC1

			Three phase
			10,0 kW
Kit			KIT-100PK3Z8
Remote controller			CZ-RTC5B
Cooling capacity	Nominal (Min - Max)	kW	9,0 (3,0 - 9,7)
EER ¹⁾	Nominal (Min - Max)	W/W	3,47 (5,36 - 3,13)
SEER ²⁾			6,5 A++
Pdesign		kW	9,0
Input power	Nominal (Min - Max)	kW	2,59 (0,56 - 3,10)
Annual energy consumption ³⁾		kWh/a	485
Heating capacity	Nominal (Min - Max)	kW	9,0 (3,0 - 10,5)
COP ¹⁾	Nominal (Min - Max)	W/W	3,93 (5,36 - 3,56)
SCOP ²⁾			3,9 A
Pdesign at -10 °C		kW	9,0
Input power	Nominal (Min - Max)	kW	2,29 (0,56 - 2,95)
Annual energy consumption ³⁾		kWh/a	3231
Indoor unit			S-6010PK3E
Air flow	Hi / Med / Lo	m ³ /min	22,0 / 18,5 / 15,0
Moisture removal volume		L/h	4,3
Sound pressure ⁴⁾	Hi / Med / Lo	dB(A)	49 / 45 / 41
Sound power	Hi / Med / Lo	dB(A)	65 / 61 / 57
Dimension	H x W x D	mm	302 x 1120 x 236
Net weight		kg	14
nanoe X Generator			Mark 2
Outdoor unit			U-100PZ3E8
Power supply		V	380 - 400 - 415
Current	Cool	A	4,30 - 4,10 - 3,95
	Heat	A	3,80 - 3,65 - 3,50
Air flow	Cool / Heat	m ³ /min	73,0 / 73,0
Sound pressure	Cool / Heat (Hi)	dB(A)	52 / 52
Sound power	Cool / Heat (Hi)	dB(A)	70 / 70
Dimension	H x W x D	mm	996 x 980 x 370
Net weight		kg	83
Piping diameter	Liquid	Inch (mm)	3/8 (9,52)
	Gas	Inch (mm)	5/8 (15,88)
Pipe length range		m	5 - 50
Elevation difference (in / out) ⁷⁾		m	15 / 30
Pre-charged pipe length		m	30
Additional gas amount		g/m	45
Refrigerant (R32) / CO ₂ Eq.		kg / T	2,4 / 1,62
Operating range	Cool Min ~ Max	°C	-10 ~ +43
	Heat Min ~ Max	°C	-15 ~ +24

1) EER and COP calculation is based in accordance to EN14511. 2) For models below 12 kW, the SEER and SCOP is calculated based on values of EU/626/2011. For models above 12 kW, the η_{net} / η_{h,s} values is calculated based on EN 14825. 3) Factory setting. 4) The sound pressure of the units shows the value measured of the position 1 m in front of the main body and 1 m below the unit. The sound pressure is measured in accordance with Eurovent 6/C/006-97 specification. 5) Connect the liquid socket tube (Ø6,35-Ø9,52) to the liquid tubing side indoor unit. 6) Connect the gas socket tube (Ø12,70-Ø15,88) to the gas tubing side indoor unit. 7) Outdoor unit located lower / outdoor unit located higher. * Recommended fuse for the indoor 3 A. ** Above values are in the case of nanoe™ X OFF.

Accessories

CZ-RTC6W	CONEX wired remote controller (non-wireless), white
CZ-RTC6WBL	CONEX wired remote controller with Bluetooth®, white
CZ-RTC6WBLW	CONEX wired remote controller with Wi-Fi and Bluetooth®, white
CZ-RTC6	CONEX wired remote controller (non-wireless), black
CZ-RTC6BL	CONEX wired remote controller with Bluetooth®, black
CZ-RTC6BLW	CONEX wired remote controller with Wi-Fi and Bluetooth®, black
CZ-RTC5B	Wired remote controller with Econavi function and datanavi
CZ-RWS3	Infrared remote controller

Accessories

CZ-CAPWFC1	Commercial Wi-Fi Adaptor
PAW-PACR4	Interface to run up to 4 indoor unit groups on backup and alternative run
PAW-WTRAY	Tray for condenser water compatible with outdoor elevation platform
PAW-GRDBSE20	Outdoor base ground support for noise and vibration absorption
PAW-GRDSTD40	Outdoor elevation platform 400x900x400 mm
CZ-CENSC1	Econavi energy saving sensor



SEER: For S-3650PK3E + U-36PZ3E5. SCOP: For S-6010PK3E + U-60PZ3E5A. INTERNET CONTROL: Optional.

Rating conditions: Cooling indoor 27 °C DB / 19 °C WB. Cooling outdoor 35 °C DB / 24 °C WB. Heating indoor 20 °C DB. Heating outdoor 7 °C DB / 6 °C WB. (DB: Dry Bulb; WB: Wet Bulb). Specifications subject to change without notice. For detailed information about ErP / Energy Labelling, please visit our websites www.aircon.panasonic.eu or www.ptc.panasonic.eu.

PACi NX Series Elite and Standard 4 way 60x60 cassette - PY3 - R32

- From 2,5 to 6,0 kW (4 capacity sizes)
- Maximum SEER: 7,3 A++ / SCOP: 4,7 A++*
- Built-in drain pump
- DC drain pump and float switch to reduce the noise
- nanoe™ X (Generator Mark 2: 9,6 trillion hydroxyl radicals/sec) as standard for better indoor air quality

* For Elite 3,6 KW model.



Elite			Single phase		
			3,6 kW	5,0 kW	6,0 kW
Kit			KIT-36PY3ZH5	KIT-50PY3ZH5	KIT-60PY3ZH5
Remote controller			CZ-RTC5B	CZ-RTC5B	CZ-RTC5B
Cooling capacity	Nominal (Min - Max)	kW	3,6(1,2 - 4,0)	5,0(1,2 - 5,6)	6,0(1,2 - 6,5)
EER ¹⁾	Nominal (Min - Max)	W/W	4,50(4,04 - 5,45)	3,76(3,41 - 5,45)	3,43(2,77 - 5,45)
SEER ²⁾			7,3 A++	7,0 A++	6,7 A++
Pdesign		kW	3,6	5,0	6,0
Input power	Nominal (Min - Max)	kW	0,80(0,22 - 0,99)	1,33(0,22 - 1,64)	1,75(0,20 - 2,35)
Annual energy consumption ³⁾		kWh/a	400	685	875
Heating capacity	Nominal (Min - Max)	kW	4,0(1,2 - 5,0)	5,6(1,2 - 6,5)	7,0(1,2 - 7,5)
COP ¹⁾	Nominal (Min - Max)	W/W	4,12(3,45 - 5,45)	3,37(2,95 - 5,45)	3,35(3,38 - 5,45)
SCOP ²⁾			4,7 A++	4,6 A++	4,3 A+
Pdesign at -10 °C		kW	3,6	4,5	4,6
Input power	Nominal (Min - Max)	kW	0,97(0,22 - 1,45)	1,66(0,22 - 2,20)	2,09(0,22 - 2,22)
Annual energy consumption ³⁾		kWh/a	1073	1370	1495
Indoor unit			S-36PY3E	S-50PY3E	S-60PY3E
Air flow	Hi / Med / Lo	m ³ /min	9,5/7,5/6,0	12,0/9,5/6,5	14,0/10,5/8,0
Moisture removal volume		L/h	1,5	2,5	2,8
Sound pressure ⁴⁾	Hi / Med / Lo	dB(A)	34/30/25	39/34/27	43/37/31
Sound power	Hi / Med / Lo	dB(A)	49/45/40	54/49/42	58/52/46
Dimension	Indoor (HxWxD)	mm	243x575x575	243x575x575	243x575x575
	Panel (HxWxD)	mm	30x625x625	30x625x625	30x625x625
Net weight	Indoor / Panel	kg	15/2,8	15/2,8	15/2,8
nanoe X Generator			Mark 2	Mark 2	Mark 2
Outdoor unit			U-36PZH3E5	U-50PZH3E5	U-60PZH3E5
Power supply		V	220 - 230 - 240	220 - 230 - 240	220 - 230 - 240
Current	Cool	A	3,95 - 3,60 - 3,60	5,30 - 5,00 - 5,75	8,20 - 7,85 - 7,60
	Heat	A	4,75 - 4,55 - 4,35	7,85 - 7,50 - 7,20	9,70 - 9,25 - 8,90
Air flow	Cool / Heat	m ³ /min	34,1/36,4	42,0/42,0	42,0/42,0
Sound pressure	Cool / Heat (Hi)	dB(A)	43/44	46/48	47/50
Sound power	Cool / Heat (Hi)	dB(A)	62/64	64/67	65/69
Dimension	HxWxD	mm	695x875x320	695x875x320	695x875x320
Net weight		kg	42	42	43
Piping diameter	Liquid	Inch (mm)	1/4 (6,35)	1/4 (6,35)	1/4 (6,35) ⁵⁾
	Gas	Inch (mm)	1/2(12,70)	1/2(12,70)	1/2(12,70) ⁶⁾
Pipe length range		m	3 - 40	3 - 40	3 - 40
Elevation difference (in / out) ⁷⁾		m	15/30	15/30	15/30
Pre-charged pipe length		m	30	30	30
Additional gas amount		g/m	15	15	15
Refrigerant (R32) / CO ₂ Eq.		kg / T	1,13/0,76	1,13/0,76	1,15/0,78
Operating range	Cool Min ~ Max	°C	-15 ~ +46	-15 ~ +46	-15 ~ +46
	Heat Min ~ Max	°C	-20 ~ +24	-20 ~ +24	-20 ~ +24

Compact and stylish design

- Required ceiling depth of only 250 mm
- Exposed area is only 30 mm

Individual flap control

Better control of the air flow with 4 motors, providing individual flap control. Perfect air distribution without direct airflow, to reduce the feeling of cold drafts.

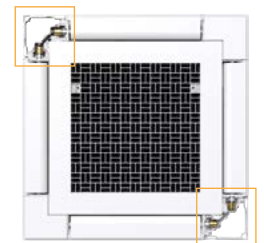

SEER and SCOP: For S-36PY3E + U-36PZH3E5. ECONAVI and INTERNET CONTROL: Optional.



CZ-RTC5B



Panel.
CZ-KPY4

COMPATIBLE WITH ALL PANASONIC CONNECTIVITY SOLUTIONS. FOR DETAILED INFORMATION GO TO THE CONTROL SYSTEMS SECTION

Optional:



Infrared remote controller.
CZ-RWS3 + CZ-RWRV3



Standard

Single phase

		Single phase			
		2,5 kW	3,6 kW	5,0 kW	6,0 kW
Kit		KIT-25PY3Z5	KIT-36PY3Z5	KIT-50PY3Z5	KIT-60PY3Z5
Remote controller		CZ-RTC5B	CZ-RTC5B	CZ-RTC5B	CZ-RTC5B
Cooling capacity	Nominal (Min - Max) kW	2,5 [1,5 - 3,9]	3,6 [1,5 - 4,0]	5,0 [1,5 - 5,6]	6,0 [2,0 - 7,0]
EER ¹⁾	Nominal (Min - Max) W/W	4,46 [3,55 - 5,88]	3,96 [3,57 - 5,88]	3,50 [3,03 - 6,25]	3,39 [2,77 - 6,90]
SEER ²⁾		6,5 A++	6,7 A++	7,3 A++	6,8 A++
Pdesign	kW	2,5	3,6	5,0	6,0
Input power	Nominal (Min - Max) kW	0,56 [0,26 - 1,10]	0,91 [0,26 - 1,12]	1,43 [0,24 - 1,85]	1,77 [0,29 - 2,53]
Annual energy consumption ³⁾	kWh/a	134	188	238	3,05
Heating capacity	Nominal (Min - Max) kW	3,2 [1,5 - 4,6]	3,6 [1,5 - 4,6]	5,0 [1,5 - 6,4]	6,0 [1,8 - 7,0]
COP ¹⁾	Nominal (Min - Max) W/W	4,44 [3,41 - 6,52]	4,29 [3,38 - 6,52]	3,94 [2,91 - 7,50]	3,61 [2,86 - 7,60]
SCOP ²⁾		4,6 A++	4,3 A+	4,4 A+	4,2 A+
Pdesign at -10 °C	kW	2,8	2,8	4,0	4,6
Input power	Nominal (Min - Max) kW	0,72 [0,23 - 1,35]	0,84 [0,23 - 1,36]	1,27 [0,20 - 2,20]	1,66 [0,24 - 2,45]
Annual energy consumption ³⁾	kWh/a	850	912	1264	1500
Indoor unit		S-25PY3E	S-36PY3E	S-50PY3E	S-60PY3E
Air flow	Hi / Med / Lo m ³ /min	8,5/7,0/6,0	9,5/7,0/6,0	12,0/9,5/6,5	14,0/10,5/8,0
Moisture removal volume	L/h	0,7	1,5	2,3	2,8
Sound pressure ⁴⁾	Hi / Med / Lo dB(A)	31/28/25	34/30/25	39/34/27	43/37/31
Sound power	Hi / Med / Lo dB(A)	46/43/40	49/45/40	54/49/42	58/52/46
Dimension	Indoor (HxWxD) mm	243x575x575	243x575x575	243x575x575	243x575x575
	Panel (HxWxD) mm	30x625x625	30x625x625	30x625x625	30x625x625
Net weight	Indoor / Panel kg	15/2,8	15/2,8	15/2,8	15/2,8
nanoe X Generator		Mark 2	Mark 2	Mark 2	Mark 2
Outdoor unit		U-25PZ3E5	U-36PZ3E5	U-50PZ3E5	U-60PZ3E5A
Power supply	V	220 - 230 - 240	220 - 230 - 240	220 - 230 - 240	220 - 230 - 240
Current	Cool A	2,65 - 2,55 - 2,45	4,20 - 4,05 - 3,85	6,65 - 6,35 - 6,10	8,20 - 7,85 - 7,55
	Heat A	3,40 - 3,25 - 3,10	3,95 - 3,75 - 3,60	5,695 - 5,70 - 5,45	7,70 - 7,35 - 7,05
Air flow	Cool / Heat m ³ /min	33,6/34,0	32,6/34,0	32,7/31,9	42,6/41,5
Sound pressure	Cool / Heat (Hi) dB(A)	46/47	46/47	46/48	47/48
Sound power	Cool / Heat (Hi) dB(A)	64/66	64/66	64/64	64/65
Dimension	H x W x D mm	619 x 824 x 299	619 x 824 x 299	619 x 824 x 299	695 x 875 x 320
Net weight	kg	32	32	35	46
Piping diameter	Liquid Inch (mm)	1/4 (6,35)	1/4 (6,35)	1/4 (6,35)	1/4 (6,35) ⁵⁾
	Gas Inch (mm)	1/2 (12,70)	1/2 (12,70)	1/2 (12,70)	1/2 (12,70) ⁶⁾
Pipe length range	m	3 - 15	3 - 15	3 - 20	3 - 40
Elevation difference (in / out) ⁷⁾	m	15/15	15/15	15/15	15/30
Pre-charged pipe length	m	7,5	7,5	7,5	30
Additional gas amount	g/m	10	10	15	15
Refrigerant (R32) / CO ₂ Eq.	kg / T	0,87/0,59	0,87/0,59	1,14/0,77	1,15/0,78
Operating range	Cool Min ~ Max °C	-10 ~ +43	-10 ~ +43	-10 ~ +43	-10 ~ +43
	Heat Min ~ Max °C	-15 ~ +24	-15 ~ +24	-15 ~ +24	-15 ~ +24

1) EER and COP calculation is based in accordance to EN14511. 2) For models below 12 kW, the SEER and SCOP is calculated based on values of EU/626/2011. For models above 12 kW, the $\eta_{s,c}$ / $\eta_{s,h}$ values is calculated based on EN 14825. 3) Factory setting. 4) The sound pressure of the units shows the value measured of the position 1,5 m below the unit. The sound pressure is measured in accordance with Eurovent 6/C/006-97 specification. 5) Connect the liquid socket tube (Ø6,35-Ø9,52) to the liquid tubing side indoor unit. 6) Connect the gas socket tube (Ø12,70-Ø15,88) to the gas tubing side indoor unit. 7) Outdoor unit located lower / outdoor unit located higher. * Recommended fuse for the indoor 3 A. ** Above values are in the case of nanoe™ X OFF.

Accessories

CZ-RTC6W	CONEX wired remote controller (non-wireless), white
CZ-RTC6WBL	CONEX wired remote controller with Bluetooth®, white
CZ-RTC6WBLW	CONEX wired remote controller with Wi-Fi and Bluetooth®, white
CZ-RTC6	CONEX wired remote controller (non-wireless), black
CZ-RTC6BL	CONEX wired remote controller with Bluetooth®, black
CZ-RTC6BLW	CONEX wired remote controller with Wi-Fi and Bluetooth®, black
CZ-RTC5B	Wired remote controller with Econavi function and datanavi
CZ-RWS3 + CZ-RWRV3	Infrared remote controller and receiver

Accessories

CZ-CAPWFC1	Commercial Wi-Fi Adaptor
PAW-PACR4	Interface to run up to 4 indoor unit groups on backup and alternative run
PAW-WTRAY	Tray for condenser water compatible with outdoor elevation platform
PAW-GRDBSE20	Outdoor base ground support for noise and vibration absorption
PAW-GRDSTD40	Outdoor elevation platform 400 x 900 x 400 mm
CZ-CENSC1	Econavi energy saving sensor



SEER: For S-50PY3E + U-50PZ3E5. SCOP: For S-25PY3E + U-25PZ3E5. ECONAVI and INTERNET CONTROL: Optional.

Rating conditions: Cooling indoor 27 °C DB / 19 °C WB. Cooling outdoor 35 °C DB / 24 °C WB. Heating indoor 20 °C DB. Heating outdoor 7 °C DB / 6 °C WB. (DB: Dry Bulb; WB: Wet Bulb). Specifications subject to change without notice. For detailed information about ErP / Energy Labelling, please visit our websites www.aircon.panasonic.eu or www.ptc.panasonic.eu.

PACi NX Series Elite 4 way 90x90 cassette - PU3 - R32

4 way 90x90 cassette - PU3.

Powerful turbo fan and intelligent Econavi sensor ensure high energy efficiency, and nanoe™ X, which is equipped as standard, provides an exceptional level of indoor air quality.



		Single phase							
		3,6 kW	5,0 kW	6,0 kW	7,1 kW	10,0 kW	12,5 kW	14,0 kW	
Kit		KIT-36PU3ZH5	KIT-50PU3ZH5	KIT-60PU3ZH5	KIT-71PU3ZH45	KIT-100PU3ZH45	KIT-125PU3ZH45	KIT-140PU3ZH45	
Remote controller		CZ-RTC5B	CZ-RTC5B	CZ-RTC5B	CZ-RTC5B	CZ-RTC5B	CZ-RTC5B	CZ-RTC5B	
Cooling capacity	Nominal (Min - Max)	kW	3,6(1,2 - 4,0)	5,0(1,2 - 5,6)	6,0(1,2 - 7,1)	7,1(2,2 - 9,0)	9,5(3,1 - 12,5)	12,5(3,2 - 14,0)	13,4(3,3 - 16,0)
EER ¹⁾	Nominal (Min - Max)	W/W	5,45(4,60 - 5,45)	4,31(3,86 - 5,45)	4,05(3,02 - 5,45)	4,06(2,69 - 5,79)	4,42(3,42 - 5,34)	3,80(3,08 - 5,33)	3,60(2,74 - 5,32)
SEER / η_{sc} ²⁾			8,9 A+++	8,6 A+++	8,0 A++	7,7 A++	7,8 A++	304,3%	286,6%
Pdesign		kW	3,6	5,0	6,0	7,1	9,5	12,5	13,4
Input power	Nominal (Min - Max)	kW	0,66(0,22 - 0,87)	1,16(0,22 - 1,45)	1,48(0,22 - 2,35)	1,75(0,38 - 3,35)	2,15(0,58 - 3,65)	3,29(0,60 - 4,55)	3,72(0,62 - 5,85)
Annual energy consumption ³⁾		kWh/a	142	203	263	323	426	—	—
Heating capacity	Nominal (Min - Max)	kW	4,0(1,2 - 5,0)	5,6(1,2 - 6,5)	7,0(1,2 - 8,0)	8,0(2,0 - 9,0)	11,2(3,1 - 14,0)	14,0(3,2 - 16,0)	16,0(3,3 - 18,0)
COP ¹⁾	Nominal (Min - Max)	W/W	5,41(4,55 - 5,45)	4,24(4,19 - 5,45)	4,02(3,40 - 5,45)	4,30(3,16 - 5,56)	5,00(3,64 - 5,54)	4,61(3,37 - 5,52)	4,30(3,27 - 5,50)
SCOP / η_{sh} ²⁾			5,1 A+++	4,9 A++	4,8 A++	4,8 A++	4,9 A++	186,0%	181,2%
Pdesign at -10 °C		kW	3,6	4,5	4,7	5,2	8,0	9,5	10,6
Input power	Nominal (Min - Max)	kW	0,74(0,22 - 1,10)	1,32(0,22 - 1,55)	1,74(0,22 - 2,35)	1,86(0,36 - 2,85)	2,24(0,56 - 3,85)	3,04(0,58 - 4,75)	3,72(0,60 - 5,50)
Annual energy consumption ³⁾		kWh/a	988	1286	1371	1517	2286	—	—
Indoor unit			S-3650PU3E	S-3650PU3E	S-6071PU3E	S-6071PU3E	S-1014PU3E	S-1014PU3E	S-1014PU3E
Air flow	Hi / Med / Lo	m ³ /min	14,5/13,0/11,5	16,5/13,5/11,5	21,0/16,0/13,0	22,0/16,0/13,0	36,0/26,0/18,0	37,0/27,0/19,0	38,0/29,0/20,0
Moisture removal volume		L/h	0,7	1,6	1,7	2,5	1,9	4,8	4,9
Sound pressure ⁴⁾	Hi / Med / Lo	dB(A)	30/28/27	32/29/27	36/31/28	37/31/28	45/38/32	46/39/33	47/40/34
Sound power	Hi / Med / Lo	dB(A)	45/43/42	47/44/42	51/46/43	52/46/43	60/53/47	61/54/48	62/55/49
Dimension	Indoor (H x W x D)	mm	256 x 840 x 840	256 x 840 x 840	256 x 840 x 840	256 x 840 x 840	319 x 840 x 840	319 x 840 x 840	319 x 840 x 840
	Panel (H x W x D)	mm	33,5 x 950 x 950	33,5 x 950 x 950	33,5 x 950 x 950	33,5 x 950 x 950	33,5 x 950 x 950	33,5 x 950 x 950	33,5 x 950 x 950
Net weight	Indoor / Panel	kg	19/5	19/5	20/5	20/5	25/5	25/5	25/5
nanoe X Generator			Mark 1	Mark 1	Mark 1	Mark 1	Mark 1	Mark 1	Mark 1
Outdoor unit			U-36PZH3E5	U-50PZH3E5	U-60PZH3E5	U-71PZH4E5	U-100PZH4E5	U-125PZH4E5	U-140PZH4E5
Power supply		V	220 - 230 - 240	220 - 230 - 240	220 - 230 - 240	220 - 230 - 240	220 - 230 - 240	220 - 230 - 240	220 - 230 - 240
Current	Cool	A	3,25 - 3,10 - 3,00	5,50 - 5,25 - 5,05	6,95 - 6,65 - 6,35	8,85 - 8,45 - 8,10	10,06 - 10,02 - 9,75	16,10 - 15,40 - 14,70	18,20 - 17,40 - 16,70
	Heat	A	3,60 - 3,45 - 3,30	6,25 - 6,00 - 5,75	8,05 - 7,70 - 7,40	9,40 - 9,00 - 8,60	10,90 - 10,60 - 10,10	14,90 - 14,20 - 13,60	18,20 - 17,40 - 16,70
Air flow	Cool / Heat	m ³ /min	34,1/36,4	42,0/42,0	42,0/42,0	62,0/66,0	76,0/70,0	86,0/78,0	89,0/83,0
Sound pressure	Cool / Heat (Hi)	dB(A)	43/44	46/48	47/50	48/50	52/52	55/55	56/56
Sound power	Cool / Heat (Hi)	dB(A)	62/64	64/67	65/69	65/67	69/69	73/73	74/74
Dimension	H x W x D	mm	695 x 875 x 320	695 x 875 x 320	695 x 875 x 320	996 x 980 x 370	996 x 980 x 370	996 x 980 x 370	996 x 980 x 370
Net weight		kg	42	42	43	66	84	86	86
Piping diameter	Liquid	Inch (mm)	1/4 (6,35)	1/4 (6,35)	1/4 (6,35) ⁵⁾	3/8 (9,52)	3/8 (9,52)	3/8 (9,52)	3/8 (9,52)
	Gas	Inch (mm)	1/2 (12,70)	1/2 (12,70)	1/2 (12,70) ⁶⁾	5/8 (15,88)	5/8 (15,88)	5/8 (15,88)	5/8 (15,88)
Pipe length range		m	3 - 40	3 - 40	3 - 40	5 - 60	5 - 100	5 - 100	5 - 100
Elevation difference (in / out) ⁷⁾		m	15/30	15/30	15/30	15/30	15/30	15/30	15/30
Pre-charged pipe length		m	30	30	30	30	30	30	30
Additional gas amount		g/m	15	15	15	30	40	40	40
Refrigerant (R32) / CO ₂ Eq.		kg / T	1,13/0,76	1,13/0,76	1,15/0,78	1,95/1,32	2,70/1,82	3,00/2,03	3,00/2,03
Operating range	Cool Min - Max	°C	-15 ~ +46	-15 ~ +46	-15 ~ +46	-15 ~ +52	-20 ⁸⁾ ~ +52	-20 ⁸⁾ ~ +52	-20 ⁸⁾ ~ +52
	Heat Min - Max	°C	-20 ~ +24	-20 ~ +24	-20 ~ +24	-20 ~ +24	-20 ~ +24	-20 ~ +24	-20 ~ +24

Technical focus

- High performance turbo fan
- Econavi: An optional intelligent sensor to reduce waste of energy
- nanoe™ X (Generator Mark 1: 4,8 trillion hydroxyl radicals/sec) as standard for better indoor air quality, indoor unit internal cleaning with nanoe™ X plus dry operation
- Lower noise in low fan operation
- Light weight, easy piping and integrated drain pump for quick installation
- Wired remote control CZ-RTC6WBL and CZ-RTC6BL allows easy system setting via Bluetooth®
- High volume fresh air input with optional air-intake plenum and chamber (CZ-FDU3+CZ-ATU2)



CZ-RTC5B



Standard panel.
CZ-KPU3W



Optional Econavi panel
(CZ-RTC5B is required).
CZ-KPU3AW

COMPATIBLE WITH ALL PANASONIC CONNECTIVITY SOLUTIONS. FOR DETAILED INFORMATION GO TO THE CONTROL SYSTEMS SECTION



Optional:



CONEX wired remote controller, white.
CZ-RTC6W/BL/BLW



CONEX wired remote controller, black.
CZ-RTC6/BL/BLW



Infrared remote controller.
CZ-RWS3 + CZ-RWRU3W

Three phase

Kit	Three phase					
	7,1 kW	10,0 kW	12,5 kW	14,0 kW		
Remote controller	KIT-71PU3ZH48	KIT-100PU3ZH48	KIT-125PU3ZH48	KIT-140PU3ZH48		
Remote controller	CZ-RTC5B	CZ-RTC5B	CZ-RTC5B	CZ-RTC5B		
Cooling capacity	Nominal (Min - Max) kW	7,1 [2,2 - 9,0]	9,5 [3,1 - 12,5]	12,5 [3,2 - 14,0]	13,4 [3,3 - 16,0]	
EER ¹⁾	Nominal (Min - Max) W/W	4,06 [2,69 - 5,79]	4,42 [3,42 - 5,34]	3,80 [3,08 - 5,33]	3,60 [2,74 - 5,32]	
SEER / η _{sc} ²⁾		7,7 A++	7,2 A++	303,0%	286,6%	
Pdesign	kW	7,1	9,5	12,5	13,4	
Input power	Nominal (Min - Max) kW	1,75 [0,38 - 3,35]	2,15 [0,58 - 3,65]	3,29 [0,60 - 4,55]	3,72 [0,62 - 5,85]	
Annual energy consumption ³⁾	kWh/a	323	426	—	—	
Heating capacity	Nominal (Min - Max) kW	8,0 [2,0 - 9,0]	11,2 [3,1 - 14,0]	14,0 [3,2 - 16,0]	16,0 [3,3 - 18,0]	
COP ¹⁾	Nominal (Min - Max) W/W	4,30 [3,16 - 5,56]	5,00 [3,64 - 5,54]	4,61 [3,37 - 5,52]	4,30 [3,27 - 5,50]	
SCOP / η _{sh} ²⁾		4,8 A++	4,9 A++	186,0%	181,1%	
Pdesign at -10 °C	kW	5,2	8,0	9,5	10,6	
Input power	Nominal (Min - Max) kW	1,86 [0,36 - 2,85]	2,24 [0,56 - 3,85]	3,04 [0,58 - 4,75]	3,72 [0,60 - 5,50]	
Annual energy consumption ³⁾	kWh/a	1517	2286	—	—	
Indoor unit		S-6071PU3E	S-1014PU3E	S-1014PU3E	S-1014PU3E	
Air flow	Hi / Med / Lo	m ³ /min	22,0 / 16,0 / 13,0	36,0 / 26,0 / 18,0	37,0 / 27,0 / 19,0	38,0 / 29,0 / 20,0
Moisture removal volume		L/h	2,5	1,9	4,8	4,9
Sound pressure ⁴⁾	Hi / Med / Lo	dB(A)	37 / 31 / 28	45 / 38 / 32	46 / 39 / 33	47 / 40 / 34
Sound power	Hi / Med / Lo	dB(A)	52 / 46 / 43	60 / 53 / 47	61 / 54 / 48	62 / 55 / 49
Dimension	Indoor (HxWxD)	mm	256 x 840 x 840	319 x 840 x 840	319 x 840 x 840	319 x 840 x 840
	Panel (HxWxD)	mm	33,5 x 950 x 950	33,5 x 950 x 950	33,5 x 950 x 950	33,5 x 950 x 950
Net weight	Indoor / Panel	kg	20 / 5	25 / 5	25 / 5	25 / 5
nanoe X Generator		Mark 1	Mark 1	Mark 1	Mark 1	
Outdoor unit		U-71PZH4E8	U-100PZH4E8	U-125PZH4E8	U-140PZH4E8	
Power supply		V	380 - 400 - 415	380 - 400 - 415	380 - 400 - 415	380 - 400 - 415
Current	Cool	A	2,95 - 2,80 - 2,70	3,60 - 3,40 - 3,25	5,45 - 5,15 - 5,00	6,15 - 5,85 - 5,65
	Heat	A	3,15 - 3,00 - 2,90	3,75 - 3,55 - 3,40	5,10 - 4,80 - 4,65	6,20 - 5,90 - 5,65
Air flow	Cool / Heat	m ³ /min	62,0 / 66,0	76,0 / 70,0	86,0 / 78,0	89,0 / 83,0
Sound pressure	Cool / Heat (Hi)	dB(A)	48 / 50	52 / 52	55 / 55	56 / 56
Sound power	Cool / Heat (Hi)	dB(A)	65 / 67	69 / 69	73 / 73	74 / 74
Dimension	H x W x D	mm	996 x 980 x 370	996 x 980 x 370	996 x 980 x 370	996 x 980 x 370
Net weight		kg	66	82	84	84
Piping diameter	Liquid	Inch (mm)	3/8 (9,52)	3/8 (9,52)	3/8 (9,52)	3/8 (9,52)
	Gas	Inch (mm)	5/8 (15,88)	5/8 (15,88)	5/8 (15,88)	5/8 (15,88)
Pipe length range		m	5 - 60	5 - 100	5 - 100	5 - 100
Elevation difference (in / out) ⁷⁾		m	15 / 30	15 / 30	15 / 30	15 / 30
Pre-charged pipe length		m	30	30	30	30
Additional gas amount		g/m	30	40	40	40
Refrigerant (R32) / CO ₂ Eq.		kg / T	1,95 / 1,32	2,70 / 1,82	3,00 / 2,03	3,00 / 2,03
Operating range	Cool Min ~ Max	°C	-15 ~ +52	-20 ⁸⁾ ~ +52	-20 ⁸⁾ ~ +52	-20 ⁸⁾ ~ +52
	Heat Min ~ Max	°C	-20 ~ +24	-20 ~ +24	-20 ~ +24	-20 ~ +24

1) EER and COP calculation is based in accordance to EN14511. 2) For models below 12 kW, the SEER and SCOP is calculated based on values of EU/626/2011. For models above 12 kW, the η_{sc} / η_{sh} values is calculated based on EN 14825. 3) Factory setting. 4) The sound pressure of the units shows the value measured of the position 1,5 m below the unit. The sound pressure is measured in accordance with Eurovent 6/C/006-97 specification. 5) Connect the liquid socket tube (Ø6,35-Ø9,52) to the liquid tubing side indoor unit. 6) Connect the gas socket tube (Ø12,70-Ø15,88) to the gas tubing side indoor unit. 7) Outdoor unit located lower / outdoor unit located higher. 8) Pipe length up to 30 m. * Recommended fuse for the indoor 3 A. ** Above values are in the case of nanoe™ X OFF.

Accessories

CZ-RTC6W	CONEX wired remote controller (non-wireless), white
CZ-RTC6WBL	CONEX wired remote controller with Bluetooth®, white
CZ-RTC6WBLW	CONEX wired remote controller with Wi-Fi and Bluetooth®, white
CZ-RTC6	CONEX wired remote controller (non-wireless), black
CZ-RTC6BL	CONEX wired remote controller with Bluetooth®, black
CZ-RTC6BLW	CONEX wired remote controller with Wi-Fi and Bluetooth®, black
CZ-RTC5B	Wired remote controller with Econavi function and datanavi
CZ-RWS3 + CZ-RWRU3W	Infrared remote controller and receiver

Accessories

CZ-CAPWFC1	Commercial Wi-Fi Adaptor
CZ-KPU3AW	Econavi exclusive panel
PAW-PACR4	Interface to run up to 4 indoor unit groups on backup and alternative run
PAW-WTRAY	Tray for condenser water compatible with outdoor elevation platform
PAW-GRDBSE20	Outdoor base ground support for noise and vibration absorption
PAW-GRDSTD40	Outdoor elevation platform 400x900x400 mm
CZ-FDU3+CZ-ATU2	Fresh air-intake kit



SEER and SCOP: For S-3650PU3E + U-36PZH3E5. ECONAVI and INTERNET CONTROL: Optional.

Rating conditions: Cooling indoor 27 °C DB / 19 °C WB. Cooling outdoor 35 °C DB / 24 °C WB. Heating indoor 20 °C DB. Heating outdoor 7 °C DB / 6 °C WB. (DB: Dry Bulb; WB: Wet Bulb). Specifications subject to change without notice. For detailed information about ErP / Energy Labelling, please visit our websites www.aircon.panasonic.eu or www.ptc.panasonic.eu.

PACi NX Series Standard 4 way 90x90 cassette - PU3 · R32

4 way 90x90 cassette - PU3.

Powerful turbo fan and intelligent Econavi sensor ensure high energy efficiency, and nanoe™ X, which is equipped as standard, provides an exceptional level of indoor air quality.



		Single phase							
		3,6 kW	5,0 kW	6,0 kW	7,1 kW	10,0 kW	12,5 kW	14,0 kW	
Kit		KIT-36PU3Z5	KIT-50PU3Z5	KIT-60PU3Z5	KIT-71PU3Z5	KIT-100PU3Z5	KIT-125PU3Z5	KIT-140PU3Z5	
Remote controller		CZ-RTC5B	CZ-RTC5B	CZ-RTC5B	CZ-RTC5B	CZ-RTC5B	CZ-RTC5B	CZ-RTC5B	
Cooling capacity	Nominal (Min - Max)	kW	3,6(1,5 - 4,0)	5,0(1,5 - 5,6)	6,0(2,0 - 7,1)	7,1(2,6 - 7,7)	10,0(3,0 - 11,5)	12,5(3,2 - 13,5)	14,0(3,3 - 15,0)
EER ¹⁾	Nominal (Min - Max)	W/W	4,34 (5,88-3,81)	3,91 (6,25-3,20)	3,73 (6,90-3,01)	3,27 (5,00-2,77)	3,82(2,88 - 5,36)	3,58(2,81 - 5,33)	3,23(2,73 - 5,32)
SEER / η_{sc} ²⁾			8,1 A++	8,0 A++	7,8 A++	6,8 A++	6,8 A++	267,0%	257,0%
Pdesign		kW	3,6	5,0	6,0	7,1	10,0	12,5	14,0
Input power	Nominal (Min - Max)	kW	0,83 (0,25-1,05)	1,28 (0,24-1,75)	1,61 (0,29-2,36)	2,17 (0,52-2,78)	2,62(0,56 - 4,00)	3,49(0,60 - 4,80)	4,34(0,62 - 5,50)
Annual energy consumption ³⁾		kWh/a	156	219	269	365	515	—	—
Heating capacity	Nominal (Min - Max)	kW	3,6(1,5 - 4,6)	5,0(1,5 - 6,4)	6,0(1,8 - 7,0)	7,1(2,1 - 8,1)	10,0(3,0 - 14,0)	12,5(3,3 - 15,0)	14,0(3,4 - 16,0)
COP ¹⁾	Nominal (Min - Max)	W/W	5,07(4,32 - 6,52)	4,63(3,48 - 7,50)	4,48(3,18 - 7,50)	4,23(3,38 - 6,36)	4,93(3,59 - 5,36)	4,43(3,57 - 5,50)	4,18(3,33 - 5,48)
SCOP / η_{sh} ²⁾			4,8 A++	4,7 A++	4,9 A++	4,6 A++	4,4 A+	157,0%	152,2%
Pdesign at -10 °C		kW	2,8	4,0	4,6	5,2	10,0	12,5	14,0 (at -7 °C)
Input power	Nominal (Min - Max)	kW	0,71 (0,23-1,06)	1,08 (0,20-1,84)	1,34 (0,24-2,20)	1,68 (0,33-2,40)	2,03(0,56 - 3,90)	2,82(0,60 - 4,20)	3,35(0,62 - 4,80)
Annual energy consumption ³⁾		kWh/a	817	1191	1314	1583	3182	—	—
Indoor unit			S-3650PU3E	S-3650PU3E	S-6071PU3E	S-6071PU3E	S-1014PU3E	S-1014PU3E	S-1014PU3E
Air flow	Hi / Med / Lo	m ³ /min	14,5/13,0/11,5	16,5/13,5/11,5	21,0/16,0/13,0	22,0/16,0/13,0	36,0/26,0/18,0	37,0/27,0/19,0	38,0/29,0/20,0
Moisture removal volume		L/h	0,7	1,6	1,7	2,5	2,7	4,8	6,0
Sound pressure ⁴⁾	Hi / Med / Lo	dB(A)	30/28/27	32/29/27	36/31/28	37/31/28	45/38/32	46/39/33	47/40/34
Sound power	Hi / Med / Lo	dB(A)	45/43/42	47/44/42	51/46/43	52/46/43	60/53/47	61/54/48	62/55/49
Dimension	Indoor (HxWxD)	mm	256x840x840	256x840x840	256x840x840	256x840x840	319x840x840	319x840x840	319x840x840
	Panel (HxWxD)	mm	33,5x950x950	33,5x950x950	33,5x950x950	33,5x950x950	33,5x950x950	33,5x950x950	33,5x950x950
Net weight	Indoor / Panel	kg	19/5	19/5	20/5	20/5	25/5	25/5	25/5
nanoe X Generator			Mark 1	Mark 1	Mark 1	Mark 1	Mark 1	Mark 1	Mark 1
Outdoor unit			U-36PZ3E5	U-50PZ3E5	U-60PZ3E5A	U-71PZ3E5A	U-100PZ3E5	U-125PZ3E5	U-140PZ3E5
Power supply		V	220 - 230 - 240	220 - 230 - 240	220 - 230 - 240	220 - 230 - 240	220 - 230 - 240	220 - 230 - 240	220 - 230 - 240
Current	Cool	A	3,85 - 3,70 - 3,55	5,95 - 5,70 - 5,45	7,45 - 7,15 - 6,85	10,00 - 9,65 - 9,25	13,10 - 12,50 - 12,00	16,90 - 16,10 - 15,40	21,00 - 20,00 - 19,20
	Heat	A	3,35 - 3,20 - 3,05	5,05 - 4,85 - 4,65	6,20 - 5,95 - 5,70	7,80 - 7,45 - 7,15	10,10 - 9,70 - 9,30	13,60 - 13,00 - 12,50	16,20 - 15,50 - 14,80
Air flow	Cool / Heat	m ³ /min	33,6/34,0	32,7/31,9	42,6/41,5	44,7/45,9	73,0/73,0	82,0/80,0	84,0/82,0
Sound pressure	Cool / Heat (Hi)	dB(A)	46/47	46/46	47/48	48/49	52/52	55/55	56/56
Sound power	Cool / Heat (Hi)	dB(A)	64/66	64/64	64/65	66/68	70/70	73/73	74/74
Dimension	HxWxD	mm	619x824x299	619x824x299	695x875x320	695x875x320	996x980x370	996x980x370	996x980x370
Net weight		kg	32	35	42	50	83	87	87
Piping diameter	Liquid	Inch (mm)	1/4 (6,35)	1/4 (6,35)	1/4 (6,35) ⁵⁾	1/4 (6,35) ⁵⁾	3/8(9,52)	3/8(9,52)	3/8(9,52)
	Gas	Inch (mm)	1/2(12,70)	1/2(12,70)	1/2(12,70) ⁶⁾	5/8(15,88)	5/8(15,88)	5/8(15,88)	5/8(15,88)
Pipe length range		m	3~15	3~20	3~40	3~40	5~50	5~50	5~50
Elevation difference (in / out) ⁷⁾		m	15/15	15/15	15/30	20/30	15/30	15/30	15/30
Pre-charged pipe length		m	7,5	7,5	30	30	30	30	30
Additional gas amount		g/m	10	15	15	17	45	45	45
Refrigerant (R32) / CO ₂ Eq.		kg / T	0,87/0,59	1,14/0,77	1,15/0,78	1,32/0,89	2,40/1,62	2,80/1,89	2,80/1,89
Operating range	Cool Min - Max	°C	-10~+43	-10~+43	-10~+43	-10~+43	-10~+43	-10~+43	-10~+43
	Heat Min - Max	°C	-15~+24	-15~+24	-15~+24	-15~+24	-15~+24	-15~+24	-15~+24

Technical focus

- High performance turbo fan
- Econavi: An optional intelligent sensor to reduce waste of energy
- nanoe™ X (Generator Mark 1: 4,8 trillion hydroxyl radicals/sec) as standard for better indoor air quality, indoor unit internal cleaning with nanoe™ X plus dry operation
- Lower noise in low fan operation
- Light weight, easy piping and integrated drain pump for quick installation
- Wired remote control CZ-RTC6WBL and CZ-RTC6BL allows easy system setting via Bluetooth®
- High volume fresh air input with optional air-intake plenum and chamber (CZ-FDU3+CZ-ATU2)



CZ-RTC5B



Standard panel.
CZ-KPU3W



Optional Econavi panel
(CZ-RTC5B is required).
CZ-KPU3AW

COMPATIBLE WITH ALL PANASONIC CONNECTIVITY SOLUTIONS. FOR DETAILED INFORMATION GO TO THE CONTROL SYSTEMS SECTION



Optional:



CONEX wired remote controller, white.
CZ-RTC6W/BL/BLW



CONEX wired remote controller, black.
CZ-RTC6/BL/BLW



Infrared remote controller.
CZ-RWS3 + CZ-RWRU3W

Kit	10,0 kW			Three phase		
	KIT-100PU3Z8			KIT-125PU3Z8		
Remote controller	CZ-RTC5B			CZ-RTC5B		
Cooling capacity	Nominal (Min - Max)	kW	10,0(3,0 - 11,5)	12,5(3,2 - 13,5)	14,0(3,3 - 15,0)	
EER ¹⁾	Nominal (Min - Max)	W/W	3,82(2,88 - 5,36)	3,58(2,81 - 5,33)	3,23(2,73 - 5,32)	
SEER / η _{s,c} ²⁾	6,7 A++			265,8%		
Pdesign		kW	10,0	12,5	14,0	
Input power	Nominal (Min - Max)	kW	2,62(0,56 - 4,00)	3,49(0,60 - 4,80)	4,34(0,62 - 5,50)	
Annual energy consumption ³⁾		kWh/a	521	—	—	
Heating capacity	Nominal (Min - Max)	kW	10,0(3,0 - 14,0)	12,5(3,3 - 15,0)	14,0(3,4 - 16,0)	
COP ¹⁾	Nominal (Min - Max)	W/W	4,93(3,59 - 5,36)	4,43(3,57 - 5,50)	4,18(3,33 - 5,48)	
SCOP / η _{s,h} ²⁾	4,4 A+			157,0%		
Pdesign at -10 °C		kW	10,0	12,5	14,0 (at -7 °C)	
Input power	Nominal (Min - Max)	kW	2,03(0,56 - 3,90)	2,82(0,60 - 4,20)	3,35(0,62 - 4,80)	
Annual energy consumption ³⁾		kWh/a	3182	—	—	
Indoor unit	S-1014PU3E			S-1014PU3E		
Air flow	Hi / Med / Lo	m ³ /min	36,0/26,0/18,0	37,0/27,0/19,0	38,0/29,0/20,0	
Moisture removal volume		L/h	2,7	4,8	6,0	
Sound pressure ⁴⁾	Hi / Med / Lo	dB(A)	45/38/32	46/39/33	47/40/34	
Sound power	Hi / Med / Lo	dB(A)	60/53/47	61/54/48	62/55/49	
Dimension	Indoor (HxWxD)	mm	319 x 840 x 840	319 x 840 x 840	319 x 840 x 840	
	Panel (HxWxD)	mm	33,5 x 950 x 950	33,5 x 950 x 950	33,5 x 950 x 950	
Net weight	Indoor / Panel	kg	25/5	25/5	25/5	
nanoe X Generator	Mark 1			Mark 1		
Outdoor unit	U-100PZ3E8			U-125PZ3E8		
Power supply		V	380 - 400 - 415	380 - 400 - 415	380 - 400 - 415	
Current	Cool	A	4,35 - 4,15 - 4,00	5,65 - 5,35 - 5,15	7,00 - 6,65 - 6,40	
	Heat	A	3,40 - 3,20 - 3,10	4,55 - 4,35 - 4,15	5,40 - 5,15 - 4,95	
Air flow	Cool / Heat	m ³ /min	73,0/73,0	82,0/80,0	84,0/82,0	
Sound pressure	Cool / Heat (Hi)	dB(A)	52/52	55/55	56/56	
Sound power	Cool / Heat (Hi)	dB(A)	70/70	73/73	74/74	
Dimension	HxWxD	mm	996x980x370	996x980x370	996x980x370	
Net weight		kg	83	87	87	
Piping diameter	Liquid	Inch (mm)	3/8(9,52)	3/8(9,52)	3/8(9,52)	
	Gas	Inch (mm)	5/8(15,88)	5/8(15,88)	5/8(15,88)	
Pipe length range		m	5 - 50	5 - 50	5 - 50	
Elevation difference (in / out) ⁷⁾		m	15/30	15/30	15/30	
Pre-charged pipe length		m	30	30	30	
Additional gas amount		g/m	45	45	45	
Refrigerant (R32) / CO ₂ Eq.		kg / T	2,40/1,62	2,80/1,89	2,80/1,89	
Operating range	Cool Min ~ Max	°C	-10 ~ +43	-10 ~ +43	-10 ~ +43	
	Heat Min ~ Max	°C	-15 ~ +24	-15 ~ +24	-15 ~ +24	

1) EER and COP calculation is based in accordance to EN14511. 2) For models below 12 kW, the SEER and SCOP is calculated based on values of EU/626/2011. For models above 12 kW, the η_{s,c} / η_{s,h} values is calculated based on EN 14825. 3) Factory setting. 4) The sound pressure of the units shows the value measured of the position 1,5 m below the unit. The sound pressure is measured in accordance with Eurovent 6/C/006-97 specification. 5) Connect the liquid socket tube (Ø6,35-Ø9,52) to the liquid tubing side indoor unit. 6) Connect the gas socket tube (Ø12,70-Ø15,88) to the gas tubing side indoor unit. 7) Outdoor unit located lower / outdoor unit located higher. * Recommended fuse for the indoor 3 A. ** Above values are in the case of nanoe™ X OFF.

Accessories

CZ-RTC6W	CONEX wired remote controller (non-wireless), white
CZ-RTC6WBL	CONEX wired remote controller with Bluetooth®, white
CZ-RTC6WBLW	CONEX wired remote controller with Wi-Fi and Bluetooth®, white
CZ-RTC6	CONEX wired remote controller (non-wireless), black
CZ-RTC6BL	CONEX wired remote controller with Bluetooth®, black
CZ-RTC6BLW	CONEX wired remote controller with Wi-Fi and Bluetooth®, black
CZ-RTC5B	Wired remote controller with Econavi function and datanavi
CZ-RWS3 + CZ-RWRU3W	Infrared remote controller and receiver

Accessories

CZ-CAPWFC1	Commercial Wi-Fi Adaptor
CZ-KPU3AW	Econavi exclusive panel
PAW-PACR4	Interface to run up to 4 indoor unit groups on backup and alternative run
PAW-WTRAY	Tray for condenser water compatible with outdoor elevation platform
PAW-GRDBSE20	Outdoor base ground support for noise and vibration absorption
PAW-GRDSTD40	Outdoor elevation platform 400x900x400 mm
CZ-FDU3+CZ-ATU2	Fresh air-intake kit



SEER: For S-3650PU3E + U-36PZ3E5. SCOP: For S-6071PU3E + U-60PZ3E5A. ECONAVI and INTERNET CONTROL: Optional.

Rating conditions: Cooling indoor 27 °C DB / 19 °C WB. Cooling outdoor 35 °C DB / 24 °C WB. Heating indoor 20 °C DB. Heating outdoor 7 °C DB / 6 °C WB. (DB: Dry Bulb; WB: Wet Bulb). Specifications subject to change without notice. For detailed information about ErP / Energy Labelling, please visit our websites www.aircon.panasonic.eu or www.ptc.panasonic.eu.

PACi NX Series Elite ceiling - PT3 · R32

Ceiling mounted units provide large and wide air distribution which is ideal for large rooms.

The height and depth of all capacities are the same for unified appearance in mixed installations.



			Single phase							
			3,6 kW	5,0 kW	6,0 kW	7,1 kW	10,0 kW	12,5 kW	14,0 kW	
Kit			KIT-36PT3ZH5	KIT-50PT3ZH5	KIT-60PT3ZH5	KIT-71PT3ZH45	KIT-100PT3ZH45	KIT-125PT3ZH45	KIT-140PT3ZH45	
Remote controller			CZ-RTC5B	CZ-RTC5B	CZ-RTC5B	CZ-RTC5B	CZ-RTC5B	CZ-RTC5B	CZ-RTC5B	
Cooling capacity	Nominal (Min - Max)	kW	3,5(1,2 - 4,0)	5,0(1,2 - 5,6)	6,0(1,2 - 7,1)	6,8(2,2 - 9,0)	9,5(3,1 - 12,5)	12,1(3,2 - 14,0)	13,4(3,3 - 16,0)	
EER ¹⁾	Nominal (Min - Max)	W/W	4,86(4,55 - 5,45)	4,03(3,57 - 5,45)	3,82(3,02 - 5,45)	3,91(2,69 - 5,79)	4,06(3,29 - 5,34)	3,46(3,01 - 5,33)	3,21(2,67 - 5,32)	
SEER / η _{sc} ²⁾			7,7 A++	7,4 A++	7,5 A++	7,3 A++	7,3 A++	278,4%	263,3%	
Pdesign			3,5	5,0	6,0	6,8	9,5	12,1	13,4	
Input power	Nominal (Min - Max)	kW	0,72(0,22 - 0,88)	1,24(0,22 - 1,57)	1,57(0,22 - 2,35)	1,74(0,38 - 3,35)	2,34(0,58 - 3,80)	3,50(0,60 - 4,65)	4,17(0,62 - 6,00)	
Annual energy consumption ³⁾			160	237	280	326	456	—	—	
Heating capacity	Nominal (Min - Max)	kW	4,0(1,2 - 5,0)	5,6(1,2 - 6,5)	7,0(1,2 - 8,0)	8,0(2,0 - 9,0)	11,2(3,1 - 14,0)	14,0(3,2 - 16,0)	16,0(3,3 - 18,0)	
COP ¹⁾	Nominal (Min - Max)	W/W	5,00(4,17 - 5,45)	4,03(3,94 - 5,45)	4,14(3,40 - 5,45)	3,96(3,16 - 5,56)	4,00(3,54 - 5,54)	3,78(3,20 - 5,52)	3,38(3,10 - 5,50)	
SCOP / η _{sh} ²⁾			4,9 A++	4,8 A++	4,8 A++	4,7 A++	4,5 A+	175,6%	169,3%	
Pdesign at -10 °C			3,1	4,0	4,6	4,7	7,8	9,5	10,2	
Input power	Nominal (Min - Max)	kW	0,80(0,22 - 1,20)	1,39(0,22 - 1,65)	1,69(0,22 - 2,35)	2,02(0,36 - 2,85)	2,80(0,56 - 3,95)	3,70(0,58 - 5,00)	4,74(0,62 - 5,80)	
Annual energy consumption ³⁾			886	1167	1342	1400	2426	—	—	
Indoor unit			S-3650PT3E	S-3650PT3E	S-6071PT3E	S-6071PT3E	S-1014PT3E	S-1014PT3E	S-1014PT3E	
Air flow	Hi / Med / Lo	m ³ /min	14,0/12,0/10,5	15,0/12,5/10,5	20,0/17,0/14,5	21,0/18,0/15,5	30,0/25,0/23,0	34,0/28,0/24,0	35,0/29,0/25,0	
Moisture removal volume			0,8	2,0	2,1	2,7	3,6	5,4	6,4	
Sound pressure ⁴⁾	Hi / Med / Lo	dB(A)	36/32/28	37/33/28	38/34/29	39/35/30	42/37/34	46/40/35	47/41/36	
Sound power	Hi / Med / Lo	dB(A)	54/50/46	55/51/46	56/52/47	57/53/48	60/55/52	64/58/53	65/59/54	
Dimension	HxWxD	mm	235x960x690	235x960x690	235x1275x690	235x1275x690	235x1590x690	235x1590x690	235x1590x690	
Net weight			26	26	34	34	40	40	40	
nanoe X Generator			Mark 2	Mark 2	Mark 2	Mark 2	Mark 2	Mark 2	Mark 2	
Outdoor unit			U-36PZH3E5	U-50PZH3E5	U-60PZH3E5	U-71PZH4E5	U-100PZH4E5	U-125PZH4E5	U-140PZH4E5	
Power supply			220 - 230 - 240	220 - 230 - 240	220 - 230 - 240	220 - 230 - 240	220 - 230 - 240	220 - 230 - 240	220 - 230 - 240	
Current	Cool	A	3,55 - 3,40 - 3,25	5,85 - 5,60 - 5,40	7,35 - 7,05 - 6,75	8,80 - 8,40 - 8,05	11,60 - 11,10 - 10,60	17,10 - 16,40 - 15,70	20,40 - 19,50 - 18,70	
	Heat	A	3,90 - 3,75 - 3,60	6,60 - 6,30 - 6,05	7,85 - 7,50 - 7,20	10,20 - 9,75 - 9,35	13,70 - 13,20 - 12,70	18,10 - 17,30 - 16,60	23,20 - 22,20 - 21,20	
Air flow	Cool / Heat	m ³ /min	34,1/36,4	42,0/42,0	42,0/42,0	62,0/66,0	76,0/70,0	86,0/78,0	89,0/83,0	
Sound pressure	Cool / Heat (Hi)	dB(A)	43/44	46/48	47/50	48/50	52/52	55/55	56/56	
Sound power	Cool / Heat (Hi)	dB(A)	62/64	64/67	65/69	65/67	69/69	73/73	74/74	
Dimension	HxWxD	mm	695x875x320	695x875x320	695x875x320	996x980x370	996x980x370	996x980x370	996x980x370	
Net weight			42	42	43	66	84	86	86	
Piping diameter	Liquid	Inch (mm)	1/4 (6,35)	1/4 (6,35)	1/4 (6,35) ⁵⁾	3/8 (9,52)	3/8 (9,52)	3/8 (9,52)	3/8 (9,52)	
	Gas	Inch (mm)	1/2 (12,70)	1/2 (12,70)	1/2 (12,70) ⁶⁾	5/8 (15,88)	5/8 (15,88)	5/8 (15,88)	5/8 (15,88)	
Pipe length range			3 - 40	3 - 40	3 - 40	5 - 60	5 - 100	5 - 100	5 - 100	
Elevation difference (in / out) ⁷⁾			15/30	15/30	15/30	15/30	15/30	15/30	15/30	
Pre-charged pipe length			30	30	30	30	30	30	30	
Additional gas amount			15	15	15	30	40	40	40	
Refrigerant (R32) / CO ₂ Eq.			1,13/0,76	1,13/0,76	1,15/0,78	1,95/1,32	2,70/1,82	3,00/2,03	3,00/2,03	
Operating range	Cool Min - Max	°C	-15 ~ +46	-15 ~ +46	-15 ~ +46	-15 ~ +52	-20 ⁸⁾ ~ +52	-20 ⁸⁾ ~ +52	-20 ⁸⁾ ~ +52	
	Heat Min - Max	°C	-20 ~ +24	-20 ~ +24	-20 ~ +24	-20 ~ +24	-20 ~ +24	-20 ~ +24	-20 ~ +24	

Technical focus

- Wide air distribution for large rooms
- Horizontal air flow reaches maximum 9,5 m
- Fresh air connection available on the unit
- Slim design with 235 mm height fits narrow space
- Silent operation
- nanoe™ X (Generator Mark 2: 9,6 trillion hydroxyl radicals/sec) as standard for better indoor air quality
- Wired remote control CZ-RTC6WBL and CZ-RTC6BL allows easy system setting via Bluetooth®
- Twin, Triple and Double-twin split options
- Easy connection and control of external fan or ERV using the connector PAW-FDC on the indoor unit PCB. The external device can be controlled by the remote control of the Panasonic indoor unit

Further comfort improvement with air flow distribution

Horizontal air flow reaches maximum 9,5 m. This is ideal for wide rooms.

The wide air discharge opening expands the air flow to the left and right. The unpleasant feeling caused when the air flow directly hits the human body is prevented by the "Draft prevention position", which changes the swing width, increasing the degree of comfort.

COMPATIBLE WITH ALL PANASONIC CONNECTIVITY SOLUTIONS. FOR DETAILED INFORMATION GO TO THE CONTROL SYSTEMS SECTION



CZ-RTC5B



Optional:

CONEX

CONEX wired remote controller, white. CZ-RTC6W/BL/BLW

CONEX

CONEX wired remote controller, black. CZ-RTC6/BL/BLW



Infrared remote controller. CZ-RWS3 + CZ-RWRT3



Econavi sensor. CZ-CENSC1

Three phase

Kit	7,1 kW		10,0 kW		12,5 kW		14,0 kW	
	KIT-71PT3ZH48		KIT-100PT3ZH48		KIT-125PT3ZH48		KIT-140PT3ZH48	
Remote controller	CZ-RTC5B		CZ-RTC5B		CZ-RTC5B		CZ-RTC5B	
Cooling capacity	Nominal (Min - Max)	kW	6,8[2,2 - 9,0]	9,5[3,1 - 12,5]	12,1[3,2 - 14,0]	13,4[3,3 - 16,0]		
EER ¹⁾	Nominal (Min - Max)	W/W	3,91[2,69 - 5,79]	4,06[3,29 - 5,34]	3,46[3,01 - 5,33]	3,21[2,67 - 5,32]		
SEER / η _{sc} ²⁾			7,2 A++	7,2 A++	277,3%	262,4%		
Pdesign		kW	6,8	9,5	12,1	13,4		
Input power	Nominal (Min - Max)	kW	1,74[0,38 - 3,35]	2,34[0,58 - 3,80]	3,50[0,60 - 4,65]	4,17[0,66 - 6,00]		
Annual energy consumption ³⁾		kWh/a	331	462	—	—		
Heating capacity	Nominal (Min - Max)	kW	8,0[2,0 - 9,0]	11,2[3,1 - 14,0]	14,0[3,2 - 16,0]	16,0[3,3 - 18,0]		
COP ¹⁾	Nominal (Min - Max)	W/W	3,96[3,16 - 5,56]	4,00[3,54 - 5,54]	3,78[3,20 - 5,52]	3,38[3,10 - 5,50]		
SCOP / η _{sh} ²⁾			4,7 A++	4,5 A+	175,6%	169,3%		
Pdesign at -10 °C		kW	4,7	7,8	9,5	10,2		
Input power	Nominal (Min - Max)	kW	2,02[0,36 - 2,85]	2,80[0,56 - 3,95]	3,70[0,58 - 5,00]	4,74[0,60 - 5,80]		
Annual energy consumption ³⁾		kWh/a	1400	2427	—	—		
Indoor unit			S-6071PT3E	S-1014PT3E	S-1014PT3E	S-1014PT3E		
Air flow	Hi / Med / Lo	m ³ /min	21,0/18,0/15,5	30,0/25,0/23,0	34,0/28,0/24,0	35,0/29,0/25,0		
Moisture removal volume		L/h	2,7	3,6	5,4	6,4		
Sound pressure ⁴⁾	Hi / Med / Lo	dB(A)	39/35/30	42/37/34	46/40/35	47/41/36		
Sound power	Hi / Med / Lo	dB(A)	57/53/48	60/55/52	64/58/53	65/59/54		
Dimension	HxWxD	mm	235x1275x690	235x1590x690	235x1590x690	235x1590x690		
Net weight		kg	34	40	40	40		
nanoe X Generator			Mark 2	Mark 2	Mark 2	Mark 2		
Outdoor unit			U-71PZH4E8	U-100PZH4E8	U-125PZH4E8	U-140PZH4E8		
Power supply		V	380 - 400 - 415	380 - 400 - 415	380 - 400 - 415	380 - 400 - 415		
Current	Cool	A	2,95 - 2,80 - 2,70	3,60 - 3,40 - 3,25	5,45 - 5,15 - 5,00	6,15 - 5,85 - 5,65		
	Heat	A	3,15 - 3,00 - 2,90	3,75 - 3,55 - 3,40	5,10 - 4,80 - 4,65	6,20 - 5,90 - 5,65		
Air flow	Cool / Heat	m ³ /min	62,0/66,0	76,0/70,0	86,0/78,0	89,0/83,0		
Sound pressure	Cool / Heat (Hi)	dB(A)	48/50	52/52	55/55	56/56		
Sound power	Cool / Heat (Hi)	dB(A)	65/67	69/69	73/73	74/74		
Dimension	HxWxD	mm	996x980x370	996x980x370	996x980x370	996x980x370		
Net weight		kg	66	82	84	84		
Piping diameter	Liquid	Inch (mm)	3/8(9,52)	3/8(9,52)	3/8(9,52)	3/8(9,52)		
	Gas	Inch (mm)	5/8(15,88)	5/8(15,88)	5/8(15,88)	5/8(15,88)		
Pipe length range		m	5 - 60	5 - 100	5 - 100	5 - 100		
Elevation difference (in / out) ⁷⁾		m	15/30	15/30	15/30	15/30		
Pre-charged pipe length		m	30	30	30	30		
Additional gas amount		g/m	30	40	40	40		
Refrigerant (R32) / CO ₂ Eq.		kg / T	1,95/1,32	2,70/1,82	3,00/2,03	3,00/2,03		
Operating range	Cool Min ~ Max	°C	-15 ~ +52	-20 ⁸⁾ ~ +52	-20 ⁸⁾ ~ +52	-20 ⁸⁾ ~ +52		
	Heat Min ~ Max	°C	-20 ~ +24	-20 ~ +24	-20 ~ +24	-20 ~ +24		

1) EER and COP calculation is based in accordance to EN14511. 2) For models below 12 kW, the SEER and SCOP is calculated based on values of EU/626/2011. For models above 12 kW, the η_{sc} / η_{sh} values is calculated based on EN 14825. 3) Factory setting. 4) The sound pressure of the units shows the value measured of the position 1 m in front of the main body and 1 m below the unit. The sound pressure is measured in accordance with Eurovent 6/C/006-97 specification. 5) Connect the liquid socket tube (Ø6,35-Ø9,52) to the liquid tubing side indoor unit. 6) Connect the gas socket tube (Ø12,70-Ø15,88) to the gas tubing side indoor unit. 7) Outdoor unit located lower / outdoor unit located higher. 8) Pipe length up to 30 m. * Recommended fuse for the indoor 3 A. ** Above values are in the case of nanoe™ X OFF.

Accessories

CZ-RTC6W	CONEX wired remote controller (non-wireless), white
CZ-RTC6WBL	CONEX wired remote controller with Bluetooth®, white
CZ-RTC6WBLW	CONEX wired remote controller with Wi-Fi and Bluetooth®, white
CZ-RTC6	CONEX wired remote controller (non-wireless), black
CZ-RTC6BL	CONEX wired remote controller with Bluetooth®, black
CZ-RTC6BLW	CONEX wired remote controller with Wi-Fi and Bluetooth®, black
CZ-RTC5B	Wired remote controller with Econavi function and datanavi
CZ-RWS3 + CZ-RWRT3	Infrared remote controller and receiver

Accessories

CZ-CAPWFC1	Commercial Wi-Fi Adaptor
PAW-PACR4	Interface to run up to 4 indoor unit groups on backup and alternative run
PAW-WTRAY	Tray for condenser water compatible with outdoor elevation platform
PAW-GRDBSE20	Outdoor base ground support for noise and vibration absorption
PAW-GRDSTD40	Outdoor elevation platform 400x900x400 mm
CZ-CENSC1	Econavi energy saving sensor



SEER and SCOP: For S-3650PT3E + U-36PZH3E5. INTERNET CONTROL: Optional.

Rating conditions: Cooling indoor 27 °C DB / 19 °C WB. Cooling outdoor 35 °C DB / 24 °C WB. Heating indoor 20 °C DB. Heating outdoor 7 °C DB / 6 °C WB. (DB: Dry Bulb, WB: Wet Bulb). Specifications subject to change without notice. For detailed information about ErP / Energy Labelling, please visit our websites www.aircon.panasonic.eu or www.ptc.panasonic.eu.

PACi NX Series Standard ceiling - PT3 · R32

Ceiling mounted units provide large and wide air distribution which is ideal for large rooms.

The height and depth of all capacities are the same for unified appearance in mixed installations.



			Single phase							
Kit			3,6 kW	5,0 kW	6,0 kW	7,1 kW	10,0 kW	12,5 kW	14,0 kW	
Remote controller			KIT-36PT3Z5	KIT-50PT3Z5	KIT-60PT3Z5	KIT-71PT3Z5	KIT-100PT3Z5	KIT-125PT3Z5	KIT-140PT3Z5	
			CZ-RTC5B	CZ-RTC5B	CZ-RTC5B	CZ-RTC5B	CZ-RTC5B	CZ-RTC5B	CZ-RTC5B	
Cooling capacity	Nominal (Min - Max)	kW	3,5(1,5 - 4,0)	5,0(1,5 - 5,2)	6,0(2,0 - 7,1)	6,8(2,6 - 7,7)	10,0(3,0 - 11,5)	12,5(3,2 - 13,5)	14,0(3,3 - 15,0)	
EER ¹⁾	Nominal (Min - Max)	W/W	4,14(3,69 - 5,17)	3,03(2,86 - 5,00)	3,59(2,90 - 6,90)	3,24(2,75 - 4,91)	3,64(2,80 - 5,36)	3,32(2,77 - 5,33)	2,98(2,73 - 5,32)	
SEER / η _{sc} ²⁾			7,2 A++	6,7 A++	7,3 A++	5,9 A+	6,6 A++	241,7%	228,8%	
Pdesign		kW	3,5	5,0	6,0	6,8	10,0	12,5	14,0	
Input power	Nominal (Min - Max)	kW	0,85(0,29 - 1,10)	1,65(0,30 - 1,82)	1,67(0,29 - 2,45)	2,10(0,53 - 2,80)	2,75(0,56 - 4,10)	3,76(0,60 - 4,88)	4,70(0,62 - 5,50)	
Annual energy consumption ³⁾		kWh/a	171	262	288	404	531	—	—	
Heating capacity	Nominal (Min - Max)	kW	3,5(1,5 - 4,6)	5,0(1,5 - 6,4)	6,0(1,8 - 7,0)	6,8(2,1 - 8,1)	10,0(3,0 - 14,0)	12,5(3,3 - 15,0)	14,0(3,4 - 16,0)	
COP ¹⁾	Nominal (Min - Max)	W/W	4,61(3,51 - 5,70)	3,73(3,12 - 6,25)	4,11(2,92 - 6,67)	4,20(3,06 - 5,68)	4,24(3,30 - 5,36)	3,89(3,41 - 4,52)	3,70(3,08 - 5,48)	
SCOP / η _{sh} ²⁾			4,4 A+	4,1 A+	4,6 A++	4,3 A+	4,2 A+	147,4%	145,3%	
Pdesign at -10 °C		kW	2,8	4,0	4,6	4,7	10,0	12,5	13,6	
Input power	Nominal (Min - Max)	kW	0,76(0,26 - 1,31)	1,34(0,24 - 2,05)	1,46(0,27 - 2,40)	1,62(0,37 - 2,65)	2,36(0,56 - 4,00)	3,21(0,73 - 4,40)	3,78(0,62 - 5,20)	
Annual energy consumption ³⁾		kWh/a	891	1365	1399	1529	3331	—	—	
Indoor unit			S-3650PT3E	S-3650PT3E	S-6071PT3E	S-6071PT3E	S-1014PT3E	S-1014PT3E	S-1014PT3E	
Air flow	Hi / Med / Lo	m ³ /min	14,0/12,0/10,5	15,0/12,5/10,5	20,0/17,0/14,5	21,0/18,0/15,5	30,0/25,0/23,0	34,0/28,0/24,0	35,0/29,0/25,0	
Moisture removal volume		L/h	0,8	2,0	2,1	2,7	4,1	5,7	6,9	
Sound pressure ⁴⁾	Hi / Med / Lo	dB(A)	36/32/28	37/33/28	38/34/29	39/35/30	42/37/34	46/40/35	47/41/36	
Sound power	Hi / Med / Lo	dB(A)	54/50/46	55/51/46	56/52/47	57/53/48	60/55/52	64/58/53	65/59/54	
Dimension	HxWxD	mm	235x960x690	235x960x690	235x1275x690	235x1275x690	235x1590x690	235x1590x690	235x1590x690	
Net weight		kg	26	26	34	34	40	40	40	
nanoe X Generator			Mark 2	Mark 2	Mark 2	Mark 2	Mark 2	Mark 2	Mark 2	
Outdoor unit			U-36PZ3E5	U-50PZ3E5	U-60PZ3E5A	U-71PZ3E5A	U-100PZ3E5	U-125PZ3E5	U-140PZ3E5	
Power supply		V	220 - 230 - 240	220 - 230 - 240	220 - 230 - 240	220 - 230 - 240	220 - 230 - 240	220 - 230 - 240	220 - 230 - 240	
Current	Cool	A	3,90 - 3,75 - 3,60	7,65 - 7,30 - 7,00	7,75 - 7,40 - 7,10	9,75 - 9,30 - 8,95	13,70 - 13,10 - 12,60	18,20 - 17,40 - 16,70	22,70 - 21,70 - 20,80	
	Heat	A	3,55 - 3,40 - 3,25	6,30 - 6,00 - 5,75	6,75 - 6,50 - 6,20	7,50 - 7,20 - 6,90	11,80 - 11,30 - 10,80	15,50 - 14,80 - 14,20	18,30 - 17,50 - 16,80	
Air flow	Cool / Heat	m ³ /min	33,6/34,0	32,7/31,9	42,6/41,5	44,7/45,9	73,0/73,0	82,0/80,0	84,0/82,0	
Sound pressure	Cool / Heat (Hi)	dB(A)	46/47	46/46	47/48	48/49	52/52	55/55	56/56	
Sound power	Cool / Heat (Hi)	dB(A)	64/66	64/64	64/65	66/68	70/70	73/73	74/74	
Dimension	HxWxD	mm	619x824x299	619x824x299	695x875x320	695x875x320	996x980x370	996x980x370	996x980x370	
Net weight		kg	32	35	42	50	83	87	87	
Piping diameter	Liquid	Inch (mm)	1/4 (6,35)	1/4 (6,35)	1/4 (6,35) ⁵⁾	1/4 (6,35) ⁵⁾	3/8 (9,52)	3/8 (9,52)	3/8 (9,52)	
	Gas	Inch (mm)	1/2(12,70)	1/2(12,70)	1/2(12,70) ⁶⁾	5/8(15,88)	5/8(15,88)	5/8(15,88)	5/8(15,88)	
Pipe length range		m	3 - 15	3 - 20	3 - 40	3 - 40	5 - 50	5 - 50	5 - 50	
Elevation difference (in / out) ⁷⁾		m	15/15	15/15	15/30	20/30	15/30	15/30	15/30	
Pre-charged pipe length		m	7,5	7,5	30	30	30	30	30	
Additional gas amount		g/m	10	15	15	17	45	45	45	
Refrigerant (R32) / CO ₂ Eq.		kg / T	0,87/0,59	1,14/0,77	1,15/0,78	1,32/0,89	2,40/1,62	2,80/1,89	2,80/1,89	
Operating range	Cool Min - Max	°C	-10 ~ +43	-10 ~ +43	-10 ~ +43	-10 ~ +43	-10 ~ +43	-10 ~ +43	-10 ~ +43	
	Heat Min - Max	°C	-15 ~ +24	-15 ~ +24	-15 ~ +24	-15 ~ +24	-15 ~ +24	-15 ~ +24	-15 ~ +24	

Technical focus

- Wide air distribution for large rooms
- Horizontal air flow reaches maximum 9,5 m
- Fresh air connection available on the unit
- Slim design with 235 mm height fits narrow space
- Silent operation
- nanoe™ X (Generator Mark 2: 9,6 trillion hydroxyl radicals/sec) as standard for better indoor air quality
- Wired remote control CZ-RTC6WBL and CZ-RTC6BL allows easy system setting via Bluetooth®
- Single and Twin options
- Easy connection and control of external fan or ERV using the connector PAW-FDC on the indoor unit PCB. The external device can be controlled by the remote control of the Panasonic indoor unit

Further comfort improvement with air flow distribution

Horizontal air flow reaches maximum 9,5 m. This is ideal for wide rooms.

The wide air discharge opening expands the air flow to the left and right. The unpleasant feeling caused when the air flow directly hits the human body is prevented by the "Draft prevention position", which changes the swing width, increasing the degree of comfort.



CZ-RTC5B

+ COMPATIBLE WITH ALL PANASONIC CONNECTIVITY SOLUTIONS. FOR DETAILED INFORMATION GO TO THE CONTROL SYSTEMS SECTION

Optional:



CONEX

CONEX wired remote controller, white. CZ-RTC6W/BL/BLW

CONEX

CONEX wired remote controller, black. CZ-RTC6/BL/BLW



Infrared remote controller. CZ-RWS3 + CZ-RWRT3



Econavi sensor. CZ-CENSC1

			Three phase		
			10,0 kW	12,5 kW	14,0 kW
Kit			KIT-100PT3Z8	KIT-125PT3Z8	KIT-140PT3Z8
Remote controller			CZ-RTC5B	CZ-RTC5B	CZ-RTC5B
Cooling capacity	Nominal (Min - Max)	kW	10,0(3,0 - 11,5)	12,5(3,2 - 13,5)	14,0(3,3 - 15,0)
EER ¹⁾	Nominal (Min - Max)	W/W	3,64(3,50 - 5,36)	3,32(2,77 - 5,33)	2,98(2,73 - 5,32)
SEER / η_{sc}²⁾			6,5 A++	241,7%	228,8%
P _{design}		kW	10,0	12,5	14,0
Input power	Nominal (Min - Max)	kW	2,75(0,56 - 4,10)	3,76(0,60 - 4,88)	4,70(0,62 - 5,50)
Annual energy consumption ³⁾		kWh/a	537	—	—
Heating capacity	Nominal (Min - Max)	kW	10,0(3,0 - 14,0)	12,5(3,3 - 15,0)	14,0(3,4 - 16,0)
COP ¹⁾	Nominal (Min - Max)	W/W	4,24(3,50 - 5,36)	3,89(3,41 - 4,52)	3,70(3,08 - 5,48)
SCOP / η_{sh}²⁾			4,2 A+	147,4%	145,3%
P _{design} at -10 °C		kW	10,0	12,5	13,6
Input power	Nominal (Min - Max)	kW	2,36(0,56 - 4,00)	3,21(0,73 - 4,40)	3,78(0,62 - 5,20)
Annual energy consumption ³⁾		kWh/a	3331	—	—
Indoor unit			S-1014PT3E	S-1014PT3E	S-1014PT3E
Air flow	Hi / Med / Lo	m ³ /min	30,0/25,0/23,0	34,0/28,0/24,0	35,0/29,0/25,0
Moisture removal volume		L/h	4,1	5,7	6,9
Sound pressure ⁴⁾	Hi / Med / Lo	dB(A)	42/37/34	46/40/35	47/41/36
Sound power	Hi / Med / Lo	dB(A)	60/55/52	64/58/53	65/59/54
Dimension	H x W x D	mm	235 x 1590 x 690	235 x 1590 x 690	235 x 1590 x 690
Net weight		kg	40	40	40
nanoe X Generator			Mark 2	Mark 2	Mark 2
Outdoor unit			U-100PZ3E8	U-125PZ3E8	U-140PZ3E8
Power supply		V	380 - 400 - 415	380 - 400 - 415	380 - 400 - 415
Current	Cool	A	4,60 - 4,35 - 4,20	6,10 - 5,75 - 5,55	7,60 - 7,20 - 6,95
	Heat	A	3,95 - 3,75 - 3,60	5,20 - 4,95 - 4,75	6,10 - 5,80 - 5,60
Air flow	Cool / Heat	m ³ /min	73,0/73,0	82,0/80,0	84,0/82,0
Sound pressure	Cool / Heat (Hi)	dB(A)	52/52	55/55	56/56
Sound power	Cool / Heat (Hi)	dB(A)	70/70	73/73	74/74
Dimension	H x W x D	mm	996 x 980 x 370	996 x 980 x 370	996 x 980 x 370
Net weight		kg	83	87	87
Piping diameter	Liquid	Inch (mm)	3/8(9,52)	3/8(9,52)	3/8(9,52)
	Gas	Inch (mm)	5/8(15,88)	5/8(15,88)	5/8(15,88)
Pipe length range		m	5 ~ 50	5 ~ 50	5 ~ 50
Elevation difference (in / out) ⁷⁾		m	15/30	15/30	15/30
Pre-charged pipe length		m	30	30	30
Additional gas amount		g/m	45	45	45
Refrigerant (R32) / CO ₂ Eq.		kg / T	2,40/1,62	2,8/1,89	2,8/1,89
Operating range	Cool Min ~ Max	°C	-10 ~ +43	-10 ~ +43	-10 ~ +43
	Heat Min ~ Max	°C	-15 ~ +24	-15 ~ +24	-15 ~ +24

1) EER and COP calculation is based in accordance to EN14511. 2) For models below 12 kW, the SEER and SCOP is calculated based on values of EU/626/2011. For models above 12 kW, the η_{sc} / η_{sh} values is calculated based on EN 14825. 3) Factory setting. 4) The sound pressure of the units shows the value measured of the position 1 m in front of the main body and 1 m below the unit. The sound pressure is measured in accordance with Eurovent 6/C/006-97 specification. 5) Connect the liquid socket tube (Ø6,35-Ø9,52) to the liquid tubing side indoor unit. 6) Connect the gas socket tube (Ø12,70-Ø15,88) to the gas tubing side indoor unit. 7) Outdoor unit located lower / outdoor unit located higher. * Recommended fuse for the indoor 3 A. ** Above values are in the case of nanoe™ X OFF.

Accessories

CZ-RTC6W	CONEX wired remote controller (non-wireless), white
CZ-RTC6WBL	CONEX wired remote controller with Bluetooth®, white
CZ-RTC6WBLW	CONEX wired remote controller with Wi-Fi and Bluetooth®, white
CZ-RTC6	CONEX wired remote controller (non-wireless), black
CZ-RTC6BL	CONEX wired remote controller with Bluetooth®, black
CZ-RTC6BLW	CONEX wired remote controller with Wi-Fi and Bluetooth®, black
CZ-RTC5B	Wired remote controller with Econavi function and datanavi
CZ-RWS3 + CZ-RWRT3	Infrared remote controller and receiver

Accessories

CZ-CAPWFC1	Commercial Wi-Fi Adaptor
PAW-PACR4	Interface to run up to 4 indoor unit groups on backup and alternative run
PAW-WTRAY	Tray for condenser water compatible with outdoor elevation platform
PAW-GRDBSE20	Outdoor base ground support for noise and vibration absorption
PAW-GRDSTD40	Outdoor elevation platform 400x900x400 mm
CZ-CENSC1	Econavi energy saving sensor



SEER and SCOP: For S-6071PT3E + U-60PZ3E8A. INTERNET CONTROL: Optional.

Rating conditions: Cooling indoor 27 °C DB / 19 °C WB. Cooling outdoor 35 °C DB / 24 °C WB. Heating indoor 20 °C DB. Heating outdoor 7 °C DB / 6 °C WB. (DB: Dry Bulb, WB: Wet Bulb). Specifications subject to change without notice. For detailed information about ErP / Energy Labelling, please visit our websites www.aircon.panasonic.eu or www.ptc.panasonic.eu.

PACi NX Series Elite adaptive ducted unit - PF3 · R32

Adaptive ducted unit - PF3.

2 installation possibilities (horizontal / vertical) with high ESP 150Pa allows flexible installation.



			Single phase							
			3,6 kW	5,0 kW	6,0 kW	7,1 kW	10,0 kW	12,5 kW	14,0 kW	
Kit			KIT-36PF3ZH5	KIT-50PF3ZH5	KIT-60PF3ZH5	KIT-71PF3ZH5	KIT-100PF3ZH5	KIT-125PF3ZH5	KIT-140PF3ZH5	
Remote controller			CZ-RTC5B	CZ-RTC5B	CZ-RTC5B	CZ-RTC5B	CZ-RTC5B	CZ-RTC5B	CZ-RTC5B	
Cooling capacity	Nominal (Min - Max)	kW	3,6(1,2 - 4,0)	5,0(1,2 - 5,6)	5,7(1,2 - 6,3)	6,8(2,2 - 7,8)	9,5(3,1 - 11,4)	12,1(3,2 - 13,6)	13,4(3,3 - 15,3)	
EER ¹⁾	Nominal (Min - Max)	W/W	4,24(3,57 - 5,45)	3,42(3,11 - 5,45)	3,68(3,15 - 5,45)	3,74(2,41 - 5,64)	4,09(2,82 - 5,08)	3,53(3,00 - 5,00)	3,38(2,59 - 4,18)	
SEER / η _{sc} ²⁾			6,8 A++	6,1 A++	7,1 A++	7,1 A++	7,4 A++	281,7%	275,9%	
Pdesign		kW	3,6	5,0	5,7	6,8	9,5	12,1	13,4	
Input power	Nominal (Min - Max)	kW	0,85(0,22 - 1,12)	1,46(0,22 - 1,80)	1,55(0,22 - 2,00)	1,82(0,39 - 3,24)	3,23(0,61 - 4,04)	3,43(0,64 - 4,54)	3,96(0,79 - 5,90)	
Annual energy consumption ³⁾		kWh/a	185	287	281	332	447	—	—	
Heating capacity	Nominal (Min - Max)	kW	4,0(1,2 - 5,0)	5,6(1,2 - 6,5)	7,0(1,2 - 8,0)	7,5(2,0 - 9,0)	10,8(3,1 - 13,5)	13,5(3,2 - 15,4)	15,5(3,3 - 17,4)	
COP ¹⁾	Nominal (Min - Max)	W/W	4,17(3,23 - 5,45)	3,61(2,97 - 5,45)	3,74(3,33 - 5,45)	4,03(3,16 - 5,41)	3,88(3,07 - 5,25)	3,46(3,06 - 5,16)	3,33(3,14 - 4,29)	
SCOP / η _{sh} ²⁾			4,5 A+	4,2 A+	4,4 A+	4,7 A++	4,3 A+	165,0%	162,6%	
Pdesign at -10 °C		kW	3,6	4,0	4,7	4,7	7,8	9,3	9,5	
Input power	Nominal (Min - Max)	kW	0,96(0,22 - 1,55)	1,55(0,22 - 2,19)	1,87(0,22 - 2,40)	1,86(0,37 - 2,85)	2,78(0,59 - 4,40)	3,90(0,62 - 5,04)	4,65(0,77 - 5,55)	
Annual energy consumption ³⁾		kWh/a	1120	1333	1495	1393	2540	—	—	
Indoor unit			S-3650PF3E	S-3650PF3E	S-6071PF3E	S-6071PF3E	S-1014PF3E	S-1014PF3E	S-1014PF3E	
External static pressure ⁴⁾	Nominal (Min - Max)	Pa	30(10 - 150)	30(10 - 150)	30(10 - 150)	30(10 - 150)	40(10 - 150)	50(10 - 150)	50(10 - 150)	
Air flow	Hi / Med / Lo	m ³ /min	14,0/13,0/10,0	16,0/15,0/12,0	21,0/19,0/15,0	21,0/19,0/15,0	20,0/26,0/21,0	34,0/29,0/23,0	36,0/32,0/25,0	
Moisture removal volume		L/h	0,9	1,9	1,7	2,7	3,2	4,1	4,9	
Sound pressure ⁵⁾	Hi / Med / Lo	dB(A)	30/27/22	34/30/25	30/26/23	30/26/23	33/29/25	35/31/27	39/35/29	
Sound power	Hi / Med / Lo	dB(A)	53/50/45	57/53/48	53/49/46	53/49/46	56/52/48	58/54/50	62/58/52	
Dimension	HxWxD	mm	250x800x730	250x800x730	250x1000x730	250x1000x730	250x1400x730	250x1400x730	250x1400x730	
Net weight		kg	25	25	30	30	39	39	39	
nanoe X Generator			Mark 2	Mark 2	Mark 2	Mark 2	Mark 2	Mark 2	Mark 2	
Outdoor unit			U-36PZH3E5	U-50PZH3E5	U-60PZH3E5	U-71PZH4E5	U-100PZH4E5	U-125PZH4E5	U-140PZH4E5	
Power supply		V	220 - 230 - 240	220 - 230 - 240	220 - 230 - 240	220 - 230 - 240	220 - 230 - 240	220 - 230 - 240	220 - 230 - 240	
Current	Cool	A	4,20 - 4,00 - 3,85	6,90 - 6,60 - 6,35	7,25 - 6,95 - 6,65	9,20 - 8,80 - 8,45	11,50 - 11,00 - 10,50	16,80 - 16,00 - 15,40	19,40 - 18,50 - 17,70	
	Heat	A	4,70 - 4,50 - 4,30	7,35 - 7,00 - 6,75	8,65 - 8,30 - 7,95	9,40 - 9,00 - 8,60	13,60 - 13,10 - 12,60	19,10 - 18,20 - 17,50	22,70 - 21,70 - 20,80	
Air flow	Cool / Heat	m ³ /min	34,1/36,4	42,0/42,0	42,0/42,0	62,0/66,0	76,0/70,0	86,0/78,0	89,0/83,0	
Sound pressure	Cool / Heat (Hi)	dB(A)	43/44	46/48	47/50	48/50	52/52	55/55	56/56	
Sound power	Cool / Heat (Hi)	dB(A)	62/64	64/67	65/69	65/67	69/69	73/73	74/74	
Dimension	HxWxD	mm	695x875x320	695x875x320	695x875x320	996x980x370	996x980x370	996x980x370	996x980x370	
Net weight		kg	42	42	43	66	84	86	86	
Piping diameter	Liquid	Inch (mm)	1/4 (6,35)	1/4 (6,35)	1/4 (6,35) ⁶⁾	3/8 (9,52)	3/8 (9,52)	3/8 (9,52)	3/8 (9,52)	
	Gas	Inch (mm)	1/2 (12,70)	1/2 (12,70)	1/2 (12,70) ⁷⁾	5/8 (15,88)	5/8 (15,88)	5/8 (15,88)	5/8 (15,88)	
Pipe length range		m	3 - 40	3 - 40	3 - 40	5 - 60	5 - 100	5 - 100	5 - 100	
Elevation difference (in / out) ⁸⁾		m	15/30	15/30	15/30	15/30	15/30	15/30	15/30	
Pre-charged pipe length		m	30	30	30	30	30	30	30	
Additional gas amount		g/m	15	15	15	30	40	40	40	
Refrigerant (R32) / CO ₂ Eq.		kg / T	1,13/0,76	1,13/0,76	1,15/0,78	1,95/1,32	2,70/1,82	3,00/2,03	3,00/2,03	
Operating range	Cool Min - Max	°C	-15 ~ +46	-15 ~ +46	-15 ~ +46	-15 ~ +52	-20 ⁹⁾ ~ +52	-20 ⁹⁾ ~ +52	-20 ⁹⁾ ~ +52	
	Heat Min - Max	°C	-20 ~ +24	-20 ~ +24	-20 ~ +24	-20 ~ +24	-20 ~ +24	-20 ~ +24	-20 ~ +24	

Technical focus

- 2 installation possibilities (horizontal / vertical)
- Maximum external static pressure: 150 Pa
- Selectable inlet air position (rear / bottom entry)
- Improved drain pan suitable for both horizontal / vertical installation
- Drain pump included
- nanoe™ X (Generator Mark 2: 9,6 trillion hydroxyl radicals/sec) as standard for the long duct piping case*
- **New** BION air pollutant filter for certain types of pollutants, such as nitrogen dioxide (NO₂), nitrogen oxides (NO_x) and Ozone (O₃) (optional)
- Wired remote control CZ-RTC6WBL and CZ-RTC6BL allows easy system setting via Bluetooth®

* The performance of nanoe™ X air can be expected even by 10 m long duct by Panasonic internal survey.

2 installation possibilities (horizontal / vertical)

Vertical installation is available. ESP 150Pa, sufficient for remotely installing units away from the rooms.



Improved drain pan design

Drain pan is shared in both cases horizontal and vertical installation. No need to modify the unit.

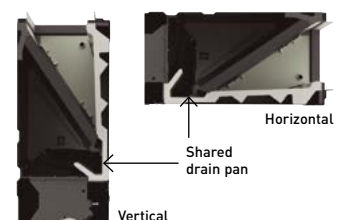



CZ-RTC5B

COMPATIBLE WITH ALL PANASONIC CONNECTIVITY SOLUTIONS. FOR DETAILED INFORMATION GO TO THE CONTROL SYSTEMS SECTION



Optional:

CONEX

CONEX wired remote controller, white. CZ-RTC6W/BL/BLW

CONEX

CONEX wired remote controller, black. CZ-RTC6/BL/BLW



Infrared remote controller. CZ-RWS3 + CZ-RWRC3

Econavi sensor. CZ-CENSC1

Three phase

Kit	Three phase				
	7,1 kW	10,0 kW	12,5 kW	14,0 kW	
Remote controller	CZ-RTC5B				
Cooling capacity	Nominal (Min - Max) kW	6,8[2,2 - 7,8]	9,5[3,1 - 11,4]	12,1[3,2 - 13,6]	13,4[3,3 - 15,3]
EER ¹⁾	Nominal (Min - Max) W/W	3,74[2,41 - 5,64]	4,09[2,82 - 5,08]	3,53[3,00 - 5,00]	3,38[2,59 - 4,18]
SEER / η _{s,c} ²⁾		7,1 A++	7,4 A++	281,0%	275,2%
Pdesign	kW	6,8	9,5	12,1	13,4
Input power	Nominal (Min - Max) kW	1,82[0,39 - 3,24]	2,32[0,61 - 4,04]	3,43[0,64 - 4,54]	3,96[0,79 - 5,90]
Annual energy consumption ³⁾	kWh/a	332	447	—	—
Heating capacity	Nominal (Min - Max) kW	7,5[2,0 - 9,0]	10,8[3,1 - 13,5]	13,5[3,2 - 15,4]	15,5[3,3 - 17,4]
COP ¹⁾	Nominal (Min - Max) W/W	4,03[3,16 - 5,41]	3,88[3,07 - 5,25]	3,46[3,06 - 5,16]	3,33[3,14 - 4,29]
SCOP / η _{s,h} ²⁾		4,7 A++	4,3 A+	165,0%	162,6%
Pdesign at -10 °C	kW	4,7	7,8	9,3	9,5
Input power	Nominal (Min - Max) kW	1,86[0,37 - 2,85]	2,78[0,59 - 4,40]	3,90[0,62 - 5,04]	4,65[0,77 - 5,55]
Annual energy consumption ³⁾	kWh/a	1394	2540	—	—
Indoor unit		S-6071PF3E	S-1014PF3E	S-1014PF3E	S-1014PF3E
External static pressure ⁴⁾	Nominal (Min - Max) Pa	30(10 - 150)	40(10 - 150)	50(10 - 150)	50(10 - 150)
Air flow	Hi / Med / Lo m ³ /min	21,0/19,0/15,0	32,0/26,0/21,0	34,0/29,0/23,0	36,0/32,0/25,0
Moisture removal volume	L/h	2,7	3,2	4,1	4,9
Sound pressure ⁵⁾	Hi / Med / Lo dB(A)	30/26/23	33/29/25	35/31/27	39/35/29
Sound power	Hi / Med / Lo dB(A)	53/49/46	56/52/48	58/54/50	62/58/52
Dimension	H x W x D mm	250 x 1000 x 730	250 x 1400 x 730	250 x 1400 x 730	250 x 1400 x 730
Net weight	kg	30	39	39	39
nanoe X Generator		Mark 2	Mark 2	Mark 2	Mark 2
Outdoor unit		U-71PZH4E8	U-100PZH4E8	U-125PZH4E8	U-140PZH4E8
Power supply	V	380 - 400 - 415	380 - 400 - 415	380 - 400 - 415	380 - 400 - 415
Current	Cool A	3,05 - 2,90 - 2,80	3,85 - 3,70 - 3,50	5,65 - 5,40 - 5,20	6,55 - 6,20 - 6,00
	Heat A	3,15 - 3,00 - 2,90	4,65 - 4,40 - 4,20	6,50 - 6,20 - 5,95	7,75 - 7,40 - 7,05
Air flow	Cool / Heat m ³ /min	62,0/66,0	76,0/70,0	86,0/78,0	89,0/83,0
Sound pressure	Cool / Heat (Hi) dB(A)	48/50	52/52	55/55	56/56
Sound power	Cool / Heat (Hi) dB(A)	65/67	69/69	73/73	74/74
Dimension	H x W x D mm	996 x 980 x 370	996 x 980 x 370	996 x 980 x 370	996 x 980 x 370
Net weight	kg	66	82	84	84
Piping diameter	Liquid Inch (mm)	3/8(9,52)	3/8(9,52)	3/8(9,52)	3/8(9,52)
	Gas Inch (mm)	5/8(15,88)	5/8(15,88)	5/8(15,88)	5/8(15,88)
Pipe length range	m	5 - 60	5 - 100	5 - 100	5 - 100
Elevation difference (in / out) ⁸⁾	m	15/30	15/30	15/30	15/30
Pre-charged pipe length	m	30	30	30	30
Additional gas amount	g/m	30	40	40	40
Refrigerant [R32] / CO ₂ Eq.	kg / T	1,95/1,32	2,70/1,82	3,00/2,03	3,00/2,03
Operating range	Cool Min ~ Max °C	-15 ~ +52	-20 ⁹⁾ ~ +52	-20 ⁹⁾ ~ +52	-20 ⁹⁾ ~ +52
	Heat Min ~ Max °C	-20 ~ +24	-20 ~ +24	-20 ~ +24	-20 ~ +24

1) EER and COP calculation is based in accordance to EN14511. 2) For models below 12 kW, the SEER and SCOP is calculated based on values of EU/626/2011. For models above 12 kW, the η_{s,c} / η_{s,h} values is calculated based on EN 14825. 3) Factory setting. 4) Medium external static pressure setting from factory. 5) The sound pressure of the units shows the value measured of the position 1,5 m below the unit. The sound pressure is measured in accordance with Eurovent 6/C/006-97 specification. 6) Connect the liquid socket tube (Ø6,35-Ø9,52) to the liquid tubing side indoor unit. 7) Connect the gas socket tube (Ø12,70-Ø15,88) to the gas tubing side indoor unit. 8) Outdoor unit located lower / outdoor unit located higher. 9) Pipe length up to 30 m. * Recommended fuse for the indoor 3 A. ** Above values are in the case of standard installation(horizontal installation in the ceiling, rear side air intake) and nanoe™ X OFF.

Accessories

CZ-RTC6W	CONEX wired remote controller (non-wireless), white
CZ-RTC6WBL	CONEX wired remote controller with Bluetooth®, white
CZ-RTC6WBLW	CONEX wired remote controller with Wi-Fi and Bluetooth®, white
CZ-RTC6	CONEX wired remote controller (non-wireless), black
CZ-RTC6BL	CONEX wired remote controller with Bluetooth®, black
CZ-RTC6BLW	CONEX wired remote controller with Wi-Fi and Bluetooth®, black
CZ-RTC5B	Wired remote controller with Econavi function and datanavi
CZ-RWS3 + CZ-RWRC3	Infrared remote controller and receiver
CZ-CAPWFC1	Commercial Wi-Fi Adaptor
PAW-PACR4	Interface to run up to 4 indoor unit groups on backup and alternative run

Accessories

PAW-WTRAY	Tray for condenser water compatible with outdoor elevation platform
PAW-GRDBSE20	Outdoor base ground support for noise and vibration absorption
PAW-GRDSTD40	Outdoor elevation platform 400 x 900 x 400 mm
CZ-CENSC1	Econavi energy saving sensor
CZ-56DAF2	Air outlet plenum for S-3650PF3E
CZ-90DAF2	Air outlet plenum for S-6071PF3E
CZ-160DAF2	Air outlet plenum for S-1014PF3E
PAW-APF800F	NEW BION air pollutant filter for S-3650PF3E
PAW-APF1000F	NEW BION air pollutant filter for S-6071PF3E
PAW-APF1400F	NEW BION air pollutant filter for S-1014PF3E



SEER and SCOP: For S-6071PF3E + U-71PZH4E5. SUPER QUIET: For S-3650PF3E + U-36PZH3E5. INTERNET CONTROL: Optional.

Rating conditions: Cooling indoor 27 °C DB / 19 °C WB. Cooling outdoor 35 °C DB / 24 °C WB. Heating indoor 20 °C DB. Heating outdoor 7 °C DB / 6 °C WB. (DB: Dry Bulb, WB: Wet Bulb). Specifications subject to change without notice. For detailed information about ErP / Energy Labelling, please visit our websites www.aircon.panasonic.eu or www.ptc.panasonic.eu.

PACi NX Series Standard adaptive ducted unit - PF3 · R32

Adaptive ducted unit - PF3.

2 installation possibilities (horizontal / vertical) with high ESP 150Pa allows flexible installation.



			Single phase						
			3,6 kW	5,0 kW	6,0 kW	7,1 kW	10,0 kW	12,5 kW	14,0 kW
Kit			KIT-36PF3Z5	KIT-50PF3Z5	KIT-60PF3Z5	KIT-71PF3Z5	KIT-100PF3Z5	KIT-125PF3Z5	KIT-140PF3Z5
Remote controller			CZ-RTC5B	CZ-RTC5B	CZ-RTC5B	CZ-RTC5B	CZ-RTC5B	CZ-RTC5B	CZ-RTC5B
Cooling capacity	Nominal (Min - Max)	kW	3,4(1,5 - 4,0)	5,0(1,5 - 5,3)	5,7(2,0 - 6,3)	6,8(2,6 - 7,7)	9,5(3,0 - 11,4)	12,1(3,2 - 13,5)	13,4(3,3 - 15,0)
EER ¹⁾	Nominal (Min - Max)	W/W	3,78(3,51 - 5,00)	2,78(2,76 - 4,63)	3,54(2,63 - 5,88)	3,18(2,69 - 4,56)	3,57(2,36 - 5,08)	3,40(2,76 - 5,08)	3,16(2,56 - 5,08)
SEER / η _{sc} ²⁾			6,0 A+	6,5 A++	6,4 A++	6,0 A+	6,6 A++	257,4%	252,2%
Pdesign	kW		3,4	5,0	5,7	6,8	9,5	12,1	13,4
Input power	Nominal (Min - Max)	kW	0,90(0,30 - 1,14)	1,80(0,32 - 1,92)	1,61(0,34 - 2,40)	2,14(0,57 - 2,86)	2,66(0,59 - 4,84)	3,56(0,63 - 4,90)	4,24(0,65 - 5,86)
Annual energy consumption ³⁾	kWh/a		198	267	310	391	502	—	—
Heating capacity	Nominal (Min - Max)	kW	3,4(1,5 - 4,6)	5,0(1,5 - 5,9)	5,7(1,8 - 7,0)	6,8(2,1 - 8,1)	9,5(3,0 - 13,5)	12,1(3,3 - 15,0)	13,4(3,4 - 16,0)
COP ¹⁾	Nominal (Min - Max)	W/W	4,15(3,51 - 5,36)	3,62(3,06 - 5,36)	4,04(2,82 - 6,21)	4,00(3,03 - 5,68)	4,09(3,00 - 5,08)	3,56(3,16 - 5,24)	3,76(3,03 - 5,23)
SCOP / η _{sh} ²⁾			4,0 A+	4,0 A+	4,4 A+	4,1 A+	3,9 A	142,6%	140,6%
Pdesign at -10 °C	kW		2,4	3,8	4,4	4,7	7,8	9,3	9,5
Input power	Nominal (Min - Max)	kW	0,82(0,28 - 1,31)	1,38(0,28 - 1,73)	1,41(0,29 - 2,48)	1,70(0,37 - 2,67)	2,32(0,59 - 4,50)	3,40(0,63 - 4,74)	3,56(0,65 - 5,28)
Annual energy consumption ³⁾	kWh/a		839	1303	1376	1591	2795	—	—
Indoor unit			S-3650PF3E	S-3650PF3E	S-6071PF3E	S-6071PF3E	S-1014PF3E	S-1014PF3E	S-1014PF3E
External static pressure ⁴⁾	Nominal (Min - Max)	Pa	30(10 - 150)	30(10 - 150)	30(10 - 150)	30(10 - 150)	40(10 - 150)	50(10 - 150)	50(10 - 150)
Air flow	Hi / Med / Lo	m ³ /min	14,0/13,0/10,0	16,0/15,0/12,0	21,0/19,0/15,0	21,0/19,0/15,0	32,0/26,0/21,0	34,0/29,0/23,0	36,0/32,0/25,0
Moisture removal volume	L/h		0,9	1,9	1,7	2,7	3,2	4,1	4,9
Sound pressure ⁵⁾	Hi / Med / Lo	dB(A)	30/27/22	34/30/25	30/26/23	30/26/23	33/29/25	35/31/27	39/35/29
Sound power	Hi / Med / Lo	dB(A)	53/50/45	57/53/48	53/49/46	53/49/46	56/52/48	58/54/50	62/58/52
Dimension	HxWxD	mm	250x800x730	250x800x730	250x1000x730	250x1000x730	250x1400x730	250x1400x730	250x1400x730
Net weight	kg		25	25	30	30	39	39	39
nanoe X Generator			Mark 2	Mark 2	Mark 2	Mark 2	Mark 2	Mark 2	Mark 2
Outdoor unit			U-36PZ3E5	U-50PZ3E5	U-60PZ3E5A	U-71PZ3E5A	U-100PZ3E5	U-125PZ3E5	U-140PZ3E5
Power supply	V		220 - 230 - 240	220 - 230 - 240	220 - 230 - 240	220 - 230 - 240	220 - 230 - 240	220 - 230 - 240	220 - 230 - 240
Current	Cool	A	4,15 - 4,00 - 3,85	8,35 - 8,00 - 7,65	7,45 - 7,15 - 6,85	9,95 - 9,50 - 9,10	13,30 - 12,70 - 12,20	17,20 - 16,40 - 15,80	20,50 - 19,60 - 18,8
	Heat	A	3,85 - 3,70 - 3,50	6,45 - 6,20 - 5,95	6,55 - 6,25 - 6,00	7,90 - 7,55 - 7,25	11,60 - 11,10 - 10,60	16,40 - 15,70 - 15,00	17,20 - 16,40 - 15,80
Air flow	Cool / Heat	m ³ /min	33,6/34,0	32,7/31,9	42,6/41,5	44,7/45,9	73,0/73,0	82,0/80,0	84,0/82,0
Sound pressure	Cool / Heat (Hi)	dB(A)	46/47	46/46	47/48	48/49	52/52	55/55	56/56
Sound power	Cool / Heat (Hi)	dB(A)	64/66	64/64	64/65	66/68	70/70	73/73	74/74
Dimension	HxWxD	mm	619x824x299	619x824x299	695x875x320	695x875x320	996x980x370	996x980x370	996x980x370
Net weight	kg		32	35	42	50	83	87	87
Piping diameter	Liquid	Inch (mm)	1/4(Ø6,35)	1/4(Ø6,35)	1/4(Ø6,35) ⁶⁾	1/4(Ø6,35) ⁶⁾	3/8(9,52)	3/8(9,52)	3/8(9,52)
	Gas	Inch (mm)	1/2(Ø12,7)	1/2(Ø12,7)	1/2(Ø12,7) ⁷⁾	5/8(Ø15,88)	5/8(15,88)	5/8(15,88)	5/8(15,88)
Pipe length range	m		3 - 15	3 - 20	3 - 40	3 - 40	5 - 50	5 - 50	5 - 50
Elevation difference (in / out) ⁸⁾	m		15/15	15/15	15/30	20/30	15/30	15/30	15/30
Pre-charged pipe length	m		7,5	7,5	30	30	30	30	30
Additional gas amount	g/m		10	15	15	17	45	45	45
Refrigerant (R32) / CO ₂ Eq.	kg / T		0,87/0,59	1,14/0,77	1,15/0,78	1,32/0,89	2,40/1,62	2,80/1,89	2,80/1,89
Operating range	Cool Min - Max	°C	-10 ~ +43	-10 ~ +43	-10 ~ +43	-10 ~ +43	-10 ~ +43	-10 ~ +43	-10 ~ +43
	Heat Min - Max	°C	-15 ~ +24	-15 ~ +24	-15 ~ +24	-15 ~ +24	-15 ~ +24	-15 ~ +24	-15 ~ +24

Technical focus

- 2 installation possibilities (horizontal / vertical)
- Maximum external static pressure: 150 Pa
- Selectable inlet air position (rear / bottom entry)
- Improved drain pan suitable for both horizontal / vertical installation
- Drain pump included
- nanoe™ X (Generator Mark 2: 9,6 trillion hydroxyl radicals/sec) as standard for the long duct piping case*
- **New** BION air pollutant filter for certain types of pollutants, such as nitrogen dioxide (NO₂), nitrogen oxides (NO_x) and Ozone (O₃) (optional)
- Wired remote control CZ-RTC6WBL and CZ-RTC6BL allows easy system setting via Bluetooth®

* The performance of nanoe™ X air can be expected even by 10 m long duct by Panasonic internal survey.

2 installation possibilities (horizontal / vertical)

Vertical installation is available. ESP 150Pa, sufficient for remotely installing units away from the rooms.



Improved drain pan design

Drain pan is shared in both cases horizontal and vertical installation. No need to modify the unit.

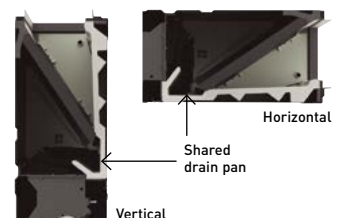



CZ-RTC5B

COMPATIBLE WITH ALL PANASONIC CONNECTIVITY SOLUTIONS. FOR DETAILED INFORMATION GO TO THE CONTROL SYSTEMS SECTION



Optional:

CONEX

CONEX wired remote controller, white. CZ-RTC6W/BL/BLW

CONEX

CONEX wired remote controller, black. CZ-RTC6/BL/BLW

Infrared remote controller. CZ-RWS3 + CZ-RWRC3

Econavi sensor. CZ-CENSC1

Kit	10,0 kW			Three phase		
	KIT-100PF3Z8			KIT-125PF3Z8		
Remote controller	CZ-RTC5B			CZ-RTC5B		
Cooling capacity	Nominal (Min - Max)	kW	9,5(3,0 - 11,4)	12,1(3,2 - 13,5)	13,4(3,3 - 15,0)	
EER ¹⁾	Nominal (Min - Max)	W/W	3,57(2,36 - 5,08)	3,40(2,76 - 5,08)	3,16(2,56 - 5,08)	
SEER / η _{s,c} ²⁾	6,5 A++			256,2%		
Pdesign		kW	9,5	12,1	13,4	
Input power	Nominal (Min - Max)	kW	2,66(0,59 - 4,84)	3,56(0,63 - 4,90)	4,24(0,65 - 5,86)	
Annual energy consumption ³⁾		kWh/a	508	—	—	
Heating capacity	Nominal (Min - Max)	kW	9,5(3,0 - 13,5)	12,1(3,3 - 15,0)	13,4(3,4 - 16,0)	
COP ¹⁾	Nominal (Min - Max)	W/W	4,09(3,00 - 5,08)	3,56(3,16 - 5,24)	3,76(3,03 - 5,23)	
SCOP / η _{s,h} ²⁾	3,9 A			142,6%		
Pdesign at -10 °C		kW	7,8	9,3	9,5	
Input power	Nominal (Min - Max)	kW	2,32(0,59 - 4,50)	3,40(0,63 - 4,74)	3,56(0,65 - 5,28)	
Annual energy consumption ³⁾		kWh/a	2795	—	—	
Indoor unit	S-1014PF3E			S-1014PF3E		
External static pressure ⁴⁾	Nominal (Min - Max)	Pa	40(10 - 150)	50(10 - 150)	50(10 - 150)	
Air flow	Hi / Med / Lo	m ³ /min	32,0/26,0/21,0	34,0/29,0/23,0	36,0/32,0/25,0	
Moisture removal volume		L/h	3,2	4,1	4,9	
Sound pressure ⁵⁾	Hi / Med / Lo	dB(A)	33/29/25	35/31/27	39/35/29	
Sound power	Hi / Med / Lo	dB(A)	56/52/48	58/54/50	62/58/52	
Dimension	H x W x D	mm	250 x 1400 x 730	250 x 1400 x 730	250 x 1400 x 730	
Net weight		kg	39	39	39	
nanoe X Generator			Mark 2	Mark 2	Mark 2	
Outdoor unit	U-100PZ3E8			U-125PZ3E8		
Power supply		V	380 - 400 - 415	380 - 400 - 415	380 - 400 - 415	
Current	Cool	A	4,45 - 4,20 - 4,05	5,75 - 5,45 - 5,25	6,85 - 6,50 - 6,30	
	Heat	A	3,85 - 3,70 - 3,55	5,50 - 5,20 - 5,05	5,75 - 5,45 - 5,25	
Air flow	Cool / Heat	m ³ /min	73,0/73,0	82,0/80,0	84,0/82,0	
Sound pressure	Cool / Heat (Hi)	dB(A)	52/52	55/55	56/56	
Sound power	Cool / Heat (Hi)	dB(A)	70/70	73/73	74/74	
Dimension	H x W x D	mm	996 x 980 x 370	996 x 980 x 370	996 x 980 x 370	
Net weight		kg	83	87	87	
Piping diameter	Liquid	Inch (mm)	3/8(9,52)	3/8(9,52)	3/8(9,52)	
	Gas	Inch (mm)	5/8(15,88)	5/8(15,88)	5/8(15,88)	
Pipe length range		m	5 - 50	5 - 50	5 - 50	
Elevation difference (in / out) ⁸⁾		m	15/30	15/30	15/30	
Pre-charged pipe length		m	30	30	30	
Additional gas amount		g/m	45	45	45	
Refrigerant (R32) / CO ₂ Eq.		kg / T	2,40/1,62	2,80/1,89	2,80/1,89	
Operating range	Cool Min ~ Max	°C	-10 ~ +43	-10 ~ +43	-10 ~ +43	
	Heat Min ~ Max	°C	-15 ~ +24	-15 ~ +24	-15 ~ +24	

1) EER and COP calculation is based in accordance to EN14511. 2) For models below 12 kW, the SEER and SCOP is calculated based on values of EU/626/2011. For models above 12 kW, the η_{s,c} / η_{s,h} values is calculated based on EN 14825. 3) Factory setting. 4) Medium external static pressure setting from factory. 5) The sound pressure of the units shows the value measured of the position 1,5 m below the unit. The sound pressure is measured in accordance with Eurovent 6/C/006-97 specification. 6) Connect the liquid socket tube (Ø6,35-Ø9,52) to the liquid tubing side indoor unit. 7) Connect the gas socket tube (Ø12,70-Ø15,88) to the gas tubing side indoor unit. 8) Outdoor unit located lower / outdoor unit located higher. * Recommended fuse for the indoor 3 A. ** Above values are in the case of standard installation(horizontal installation in the ceiling, rear side air intake) and nanoe™ X OFF.

Accessories	
CZ-RTC6W	CONEX wired remote controller (non-wireless), white
CZ-RTC6WBL	CONEX wired remote controller with Bluetooth®, white
CZ-RTC6WBLW	CONEX wired remote controller with Wi-Fi and Bluetooth®, white
CZ-RTC6	CONEX wired remote controller (non-wireless), black
CZ-RTC6BL	CONEX wired remote controller with Bluetooth®, black
CZ-RTC6BLW	CONEX wired remote controller with Wi-Fi and Bluetooth®, black
CZ-RTC5B	Wired remote controller with Econavi function and datanavi
CZ-RWS3 + CZ-RWRC3	Infrared remote controller and receiver
CZ-CAPWFC1	Commercial Wi-Fi Adaptor
PAW-PACR4	Interface to run up to 4 indoor unit groups on backup and alternative run

Accessories	
PAW-WTRAY	Tray for condenser water compatible with outdoor elevation platform
PAW-GRDBSE20	Outdoor base ground support for noise and vibration absorption
PAW-GRDSTD40	Outdoor elevation platform 400x900x400 mm
CZ-CENSC1	Econavi energy saving sensor
CZ-56DAF2	Air outlet plenum for S-3650PF3E
CZ-90DAF2	Air outlet plenum for S-6071PF3E
CZ-160DAF2	Air outlet plenum for S-1014PF3E
PAW-APF800F	NEW BION air pollutant filter for S-3650PF3E
PAW-APF1000F	NEW BION air pollutant filter for S-6071PF3E
PAW-APF1400F	NEW BION air pollutant filter for S-1014PF3E

R32

6,6 SEER

4,4 SCOP

INVERTER+

-10 °C COOLING MODE

-15 °C HEATING MODE

nanoeX

22 dB(A)

DC FAN

FILTER INCLUDED

R22/R410A/R32 RENEWAL

OPTIONAL WI-FI

BMS CONNECTIVITY

5 YEARS COMPRESSOR WARRANTY

SEER: For S-1014PF3E + U-100PZ3E5. SCOP: For S-6071PF3E + U-60PZ3E5A. SUPER QUIET: For S-3650PF3E + U-36PZ3E5. INTERNET CONTROL: Optional.

Rating conditions: Cooling indoor 27 °C DB / 19 °C WB. Cooling outdoor 35 °C DB / 24 °C WB. Heating indoor 20 °C DB. Heating outdoor 7 °C DB / 6 °C WB. (DB: Dry Bulb; WB: Wet Bulb). Specifications subject to change without notice. For detailed information about ErP / Energy Labelling, please visit our websites www.aircon.panasonic.eu or www.ptc.panasonic.eu.

NEW Big PACi NX high static pressure hide-away 20,0-25,0 kW · R32

+ COMPATIBLE WITH ALL PANASONIC CONNECTIVITY SOLUTIONS. FOR DETAILED INFORMATION GO TO THE CONTROL SYSTEMS SECTION

Optional:



			Three phase	
			20,0 kW	25,0 kW
Kit			KIT-200PE4ZH8	KIT-250PE4ZH8
Remote controller			CZ-RTC5B	CZ-RTC5B
Cooling capacity	Nominal (Min - Max)	kW	19,0 [5,7 - 20,0]	22,0 [6,1 - 25,6]
EER ¹⁾	Nominal (Min - Max)	W/W	3,20 [2,78 - 4,60]	2,74 [2,49 - 4,88]
SEER / η_{s,c} ²⁾			237,8%	213,0%
Pdesign		kW	19,0	22,0
Input power	Nominal (Min - Max)	kW	5,93 [1,24 - 7,20]	8,04 [1,25 - 10,30]
Heating capacity	Nominal (Min - Max)	kW	22,4 [5,0 - 24,5]	24,0 [5,5 - 27,6]
COP ¹⁾	Nominal (Min - Max)	W/W	3,55 [3,27 - 4,76]	3,55 [3,07 - 4,78]
SCOP / η_{s,h} ²⁾			146,0%	145,0%
Pdesign at -10 °C		kW	16,0	17,2
Input power	Nominal (Min - Max)	kW	6,31 [1,05 - 7,50]	6,76 [1,15 - 9,00]
Indoor unit			S-200PE4E	S-250PE4E
Power supply		V / ph / Hz	220 - 230 - 240 / 1 / 50	220 - 230 - 240 / 1 / 50
External static pressure at shipment (adjustable)		Pa	75 ³⁾ [120 / 180]	75 ³⁾ [130 / 200]
Air flow	Hi / Med / Lo	m ³ /min	72/63/53	84/72/59
Sound pressure ⁴⁾	Hi / Med / Lo	dB(A)	46/44/41	47/45/42
Dimension / Net weight	HxWxD	mm / kg	486 x 1456 x 916 / 83	486 x 1456 x 916 / 87
Outdoor unit			U-200PZH4E8	U-250PZH4E8
Power supply		V / ph / Hz	380 - 400 - 415 / 3 / 50	380 - 400 - 415 / 3 / 50
Recommended fuse		A	30	30
Air flow	Cool / Heat	m ³ /min	116 / 136	116 / 148
Sound pressure	Cool / Heat (Hi)	dB(A)	57 / 61	57 / 63
Sound power	Cool / Heat (Hi)	dB(A)	76 / 80	76 / 82
Dimension ⁵⁾ / Net weight	HxWxD	mm / kg	996 x 1140 x 460 / 109	996 x 1140 x 460 / 109
Piping diameter	Liquid / Gas	Inch (mm)	1/2 [12,7] / 7/8 [22,22]	1/2 [12,7] / 7/8 [22,22]
Pipe length range / Elevation difference (in / out)	m / m		5 ~ 100 / 30	5 ~ 100 / 30
Pre-charged pipe length / Additional gas amount	m / g/m		30 / 80	30 / 80
Refrigerant [R32] / CO ₂ Eq.		kg / T	4,8 / 3,24	4,8 / 3,24
Operating range	Cool Min ~ Max	°C	-15 ~ +52	-15 ~ +52
	Heat Min ~ Max	°C	-20 ~ +35	-20 ~ +35

1) EER and COP calculation is based in accordance to EN14511. 2) For models below 12 kW, the SEER and SCOP is calculated based on values of EU/626/2011. For models above 12 kW, the η_{s,c} / η_{s,h} values is calculated based on EN 14825. 3) Factory setting. 4) The sound pressure of the units shows the value measured of the position 1,5 m below the unit. The sound pressure is measured in accordance with Eurovent 6/C/006-97 specification. 5) Add 100 mm for indoor unit or 70 mm for outdoor unit for piping port.

Accessories	
CZ-RTC6W	CONEX wired remote controller (non-wireless), white
CZ-RTC6WBL	CONEX wired remote controller with Bluetooth®, white
CZ-RTC6WBLW	CONEX wired remote controller with Wi-Fi and Bluetooth®, white
CZ-RTC6	CONEX wired remote controller (non-wireless), black
CZ-RTC6BL	CONEX wired remote controller with Bluetooth®, black
CZ-RTC6BLW	CONEX wired remote controller with Wi-Fi and Bluetooth®, black
CZ-RTC5B	Wired remote controller with Econavi function and datanavi
CZ-RWS3 + CZ-RWRC3	Infrared remote controller and receiver

Accessories	
CZ-CAPWFC1	Commercial Wi-Fi Adaptor
PAW-PACR4	Interface to run up to 4 indoor unit groups on backup and alternative run
PAW-GRDSTD1100	Outdoor ground stand
PAW-GRDSTDHTR1100	Outdoor base pan heater
PAW-GRDBSE20	Outdoor base ground support for noise and vibration absorption
CZ-CENSC1	Econavi energy saving sensor

Demand response compliant as a standard function

Several setting levels are available:

- Level-1, 2, 3: 75 / 50 / 0%
 - Level-1, 2 can be set in 40 - 100% (40, 45, 50...95, 100: each 5%)
- It allows for forced stop which can be used for fire-alarm connection on LV3.

* PAW-OPT-NX is required.

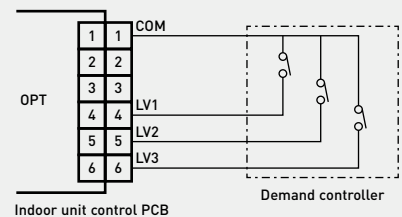

INTERNET CONTROL: Optional.

Big PACi high static pressure hide-away 20,0-25,0 kW · R32

+ COMPATIBLE WITH ALL PANASONIC CONNECTIVITY SOLUTIONS. FOR DETAILED INFORMATION GO TO THE CONTROL SYSTEMS SECTION

Optional:



			Three phase	
			20,0 kW	25,0 kW
Kit			KIT-200PE3ZH8	KIT-250PE3ZH8
Remote controller			CZ-RTC5B	CZ-RTC5B
Cooling capacity	Nominal (Min - Max)	kW	19,5 [5,7 - 21,0]	23,2 [6,1 - 27,0]
EER ¹⁾	Nominal (Min - Max)	W/W	3,22 [3,09 - 4,52]	3,11 [2,93 - 4,59]
SEER / η _{sc} ²⁾			207,0%	190,6%
P _{design}		kW	19,5	23,2
Input power	Nominal (Min - Max)	kW	6,06 [1,26 - 6,80]	7,46 [1,33 - 9,20]
Heating capacity	Nominal (Min - Max)	kW	22,4 [5,0 - 25,0]	28,0 [5,5 - 29,0]
COP ¹⁾	Nominal (Min - Max)	W/W	3,61 [3,16 - 4,76]	3,41 [3,05 - 5,00]
SCOP / η _{s,h} ²⁾			141,3%	142,7%
P _{design} at -10 °C		kW	17,0	20,0
Input power	Nominal (Min - Max)	kW	6,21 [1,05 - 7,90]	8,21 [1,10 - 9,50]
Indoor unit			S-200PE3E5B	S-250PE3E5B
Power supply		V / ph / Hz	220 - 230 - 240 / 1 / 50	220 - 230 - 240 / 1 / 50
External static pressure at shipment (adjustable)		Pa	75 ³⁾ [120 / 180]	75 ³⁾ [130 / 200]
Air flow	Hi / Med / Lo	m ³ /min	72 / 63 / 53	84 / 72 / 59
Sound pressure ⁴⁾	Hi / Med / Lo	dB(A)	46 / 44 / 41	47 / 45 / 42
Dimension / Net weight	H x W x D	mm / kg	486 x 1456 x 916 / 86	486 x 1456 x 916 / 88
Outdoor unit			U-200PZH2E8	U-250PZH2E8
Power supply		V / ph / Hz	380 - 400 - 415 / 3 / 50	380 - 400 - 415 / 3 / 50
Recommended fuse		A	30	30
Air flow	Cool / Heat	m ³ /min	164 / 164	160 / 160
Sound pressure	Cool / Heat (Hi)	dB(A)	59 / 61	59 / 63
Sound power	Cool / Heat (Hi)	dB(A)	77 / 79	78 / 82
Dimension ⁵⁾ / Net weight	H x W x D	mm / kg	1500 x 980 x 370 / 117	1500 x 980 x 370 / 128
Piping diameter	Liquid / Gas	Inch (mm)	3/8 [9,52] / 1 [25,40]	1/2 [12,70] / 1 [25,40]
Pipe length range / Elevation difference (in / out)	m / m		5 - 90 / 30	5 - 60 / 30
Pre-charged pipe length / Additional gas amount	m / g/m		30 / 60	30 / 80
Refrigerant (R32) / CO ₂ Eq.		kg / T	4,20 / 2,835	5,20 / 3,51
Operating range	Cool Min ~ Max	°C	-15 ~ +46	-15 ~ +46
	Heat Min ~ Max	°C	-20 ~ +24	-20 ~ +24

1) EER and COP calculation is based in accordance to EN14511. 2) For models below 12 kW, the SEER and SCOP is calculated based on values of EU/626/2011. For models above 12 kW, the η_{sc} / η_{s,h} values is calculated based on EN 14825. 3) Factory setting. 4) The sound pressure of the units shows the value measured of the position 1,5 m below the unit. The sound pressure is measured in accordance with Eurovent 6/C/006-97 specification. 5) Add 100 mm for indoor unit or 70 mm for outdoor unit for piping port. * No filter included.

Accessories	
CZ-RTC6W	CONEX wired remote controller (non-wireless), white
CZ-RTC6WBL	CONEX wired remote controller with Bluetooth®, white
CZ-RTC6	CONEX wired remote controller (non-wireless), black
CZ-RTC6BL	CONEX wired remote controller with Bluetooth®, black
CZ-RTC5B	Wired remote controller with Econavi function and datanavi
CZ-RWS3 + CZ-RWRC3	Infrared remote controller and receiver

Accessories	
CZ-CAPDC3	Demand control for PACi and Mini ECOi outdoor units
CZ-CAPWFC1	Commercial Wi-Fi Adaptor
PAW-PACR4	Interface to run up to 4 indoor unit groups on backup and alternative run
PAW-GRDBSE20	Outdoor base ground support for noise and vibration absorption
PAW-GRDSTD40	Outdoor elevation platform 400 x 900 x 400 mm
CZ-CENSC1	Econavi energy saving sensor

Demand response compliant as a standard function

CZ-CAPDC3. This terminal allows demand control of the outdoor unit.

Several setting levels are available:
 · Level-1, 2, 3: 75 / 50 / 0%
 · Level-1, 2 can be set in 40 - 100% (40, 45, 50...95, 100: each 5%)
 CZ-CAPDC3 also allows for forced stop which can be used for fire-alarm connection on LV3.

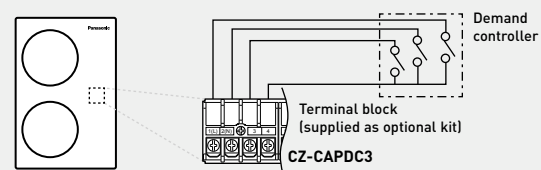

INTERNET CONTROL: Optional.

Rating conditions: Cooling indoor 27 °C DB / 19 °C WB. Cooling outdoor 35 °C DB / 24 °C WB. Heating indoor 20 °C DB. Heating outdoor 7 °C DB / 6 °C WB. (DB: Dry Bulb; WB: Wet Bulb). Specifications subject to change without notice. For detailed information about ErP / Energy Labelling, please visit our websites www.aircon.panasonic.eu or www.ptc.panasonic.eu.

Commercial twin, triple and double-twin systems · R32

With this system, a single outdoor unit can split its capacity simultaneously across up to 4 indoor units, for better distribution within the space. This makes the system particularly apt for common areas. It reduces noise concentration and enables the same temperature to be reached around the room. A wide variety of the same type of indoor units can be connected in multi combinations (including wall-mounted, cassette, hide-away and ceiling).



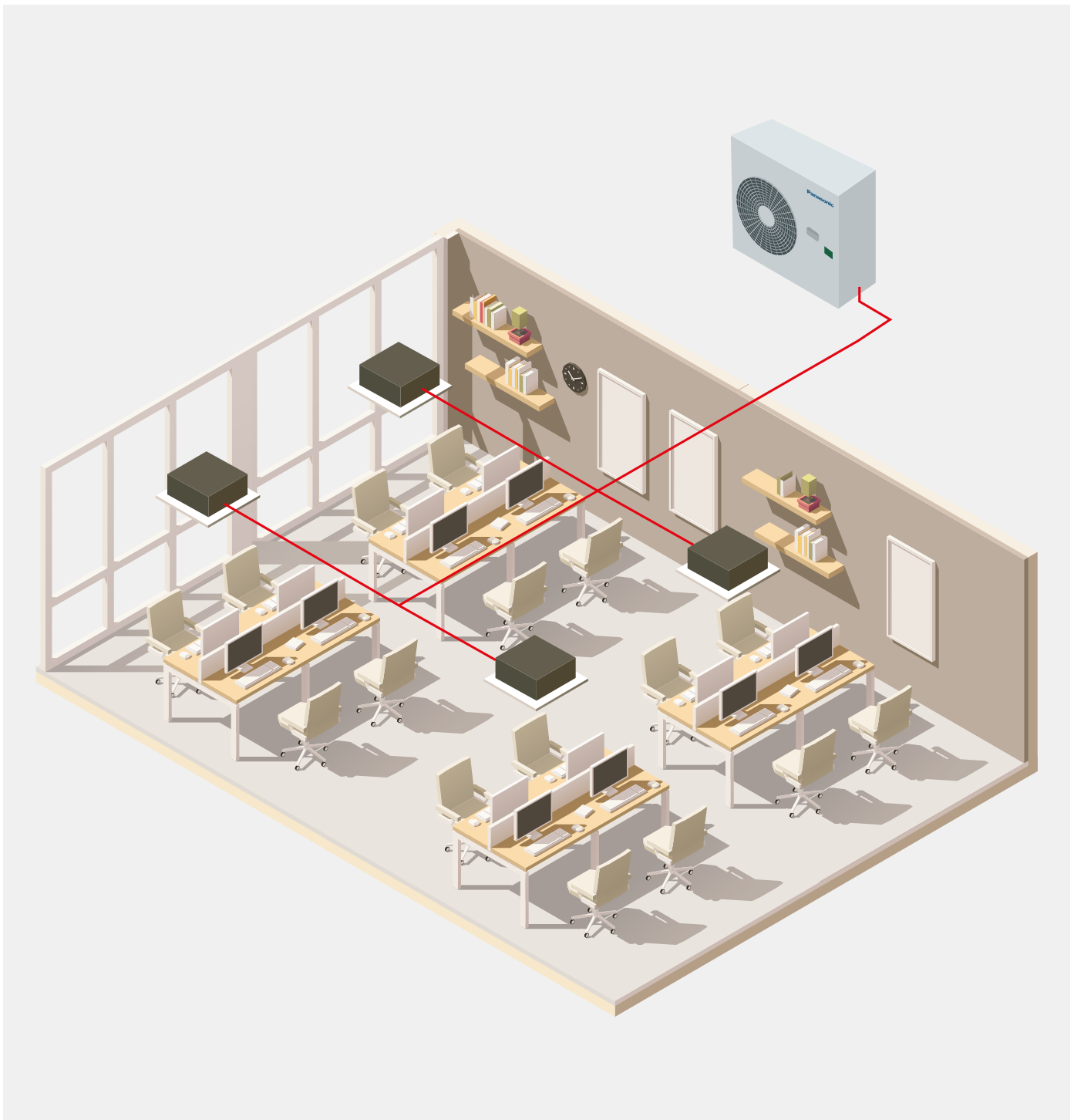

1 PACi NX Elite from 7,1 to 14,0 kW

Up to 4 indoor units can be connected to the same outdoor unit. Panasonic's Elite units 7,1, 10,0, 12,0 and 14,0 can be installed as twin, triple and double-twin systems. The indoor units can be combined as per the selection table. The operation will always be simultaneous. All the indoor units will work with the same settings.

2 PACi NX Standard from 10,0 to 14,0 kW

Up to 2 indoor units connectable on the same outdoor. Panasonic's Standard units can be installed as single and twin systems. The indoor units can be combined following the selection table. The operation will always be simultaneous. All the indoor units will work with the same settings.

3 Big PACi NX and Big PACi Elite from 20,0 to 25,0 kW

Up to 4 indoor units can be connected to the same outdoor unit. Panasonic's PACi units 20,0 and 25,0 can be installed as twin, triple and double-twin systems. The indoor units can be combined as per the selection table. The operation will always be simultaneous. All the indoor units will work with the same settings.

Commercial twin, triple and double-twin systems - R32



PACi NX Elite and PACi Elite outdoor units - R32

			PACi NX				Big PACi NX		Big PACi	
			7,1 kW	10,0 kW	12,5 kW	14,0 kW	20,0 kW	25,0 kW	20,0 kW	25,0 kW
Outdoor unit single phase			U-71PZH4E5	U-100PZH4E5	U-125PZH4E5	U-140PZH4E5	—	—	—	—
Outdoor unit three phase			U-71PZH4E8	U-100PZH4E8	U-125PZH4E8	U-140PZH4E8	U-200PZH4E8	U-250PZH4E8	U-200PZH2E8	U-250PZH2E8
Cooling capacity ¹⁾	Nominal (Min - Max)	kW	7,1 [2,2 - 9,0]	9,5 [3,1 - 12,5]	12,5 [3,2 - 14,0]	13,4 [3,3 - 16,0]	19,0 [5,7 - 20,0]	22,0 [6,1 - 25,6]	20,0 [5,7 - 22,4]	25,0 [6,1 - 28,0]
Heating capacity ¹⁾	Nominal (Min - Max)	kW	8,0 [2,0 - 9,0]	11,2 [3,1 - 14,0]	14,0 [3,2 - 16,0]	16,0 [3,3 - 18,0]	22,4 [5,0 - 24,5]	24,0 [5,5 - 27,6]	22,4 [5,0 - 25,0]	28,0 [5,5 - 31,5]
Power supply	Single phase	V	220-230-240	220-230-240	220-230-240	220-230-240	—	—	—	—
	Three phase	V	380-400-415	380-400-415	380-400-415	380-400-415	380-400-415	380-400-415	380-400-415	380-400-415
Connection indoor / outdoor		mm ²	2x1,5 or 2,5	2x1,5 or 2,5	2x1,5 or 2,5	2x1,5 or 2,5	—	—	—	—
Air flow	Cool / Heat	m ³ /min	62,0/66,0	76,0/70,0	86,0/78,0	89,0/83,0	164/164	160/160	164/164	160/160
Sound pressure	Cool / Heat (Hi)	dB(A)	48/50	52/52	55/55	56/56	59/61	59/63	59/61	59/63
Sound power	Cool / Heat (Hi)	dB(A)	65/67	69/69	73/73	74/74	77/79	78/82	77/79	78/82
Dimension	H x W x D	mm	996x980x370	996x980x370	996x980x370	996x980x370	996x1140x460	996x1140x460	1500x980x370	1500x980x370
Net weight	1ph / 3ph	kg	66	84/82	86/84	86/84	190	190	117	128
	Liquid	Inch (mm)	3/8 (9,52)	3/8 (9,52)	3/8 (9,52)	3/8 (9,52)	1/2 (12,70)	1/2 (12,70)	3/8 (9,52)	1/2 (12,70)
Piping diameter	Gas	Inch (mm)	5/8 (15,88)	5/8 (15,88)	5/8 (15,88)	5/8 (15,88)	7/8 (22,22)	7/8 (22,22)	1 (25,40)	1 (25,40)
	Min - Max	m	5 - 60	5 - 100	5 - 100	5 - 100	5 - 100	5 - 100	5 - 90	5 - 60
Elevation difference (in / out)	Max	m	15/30 ²⁾	15/30 ²⁾	15/30 ²⁾	15/30 ²⁾	30	30	30	30
Pre-charged pipe length		m	30	30	30	30	30	30	30	30
Additional gas amount		g/m	30	40	40	40	80	80	60	80
Refrigerant (R32) / CO ₂ Eq.		kg / T	1,95/1,32	2,70/1,82	3,00/2,03	3,00/2,03	4,80/3,24	4,80/3,24	4,20/2,835	5,20/3,51
Operating range	Cool Min ~ Max	°C	-15 ~ +52	-20 ³⁾ ~ +52	-20 ³⁾ ~ +52	-20 ³⁾ ~ +52	-15 ~ +52	-15 ~ +52	-15 ~ +46	-15 ~ +46
	Heat Min ~ Max	°C	-20 ~ +24	-20 ~ +24	-20 ~ +24	-20 ~ +24	-20 ~ +35	-20 ~ +35	-20 ~ +24	-20 ~ +24

1) 7,1 - 14,0 kW with 4 way 90x90 cassette. 20,0 - 25,0 kW with high static pressure hide-away. 2) Outdoor unit located lower / outdoor unit located higher. 3) Pipe length up to 30 m.



PACi NX Standard outdoor units - R32

			10,0 kW	12,5 kW	14,0 kW
Outdoor unit single phase			U-100PZ3E5	U-125PZ3E5	U-140PZ3E5
Outdoor unit three phase			U-100PZ3E8	U-125PZ3E8	U-140PZ3E8
Cooling capacity ¹⁾	Nominal (Min - Max)	kW	10,0 [3,0 - 11,5]	12,5 [3,2 - 13,5]	14,0 [3,3 - 15,0]
Heating capacity ¹⁾	Nominal (Min - Max)	kW	10,0 [3,0 - 14,0]	12,5 [3,3 - 15,0]	14,0 [3,4 - 16,0]
Power supply	Single phase	V	220-230-240	220-230-240	220-230-240
	Three phase	V	380-400-415	380-400-415	380-400-415
Connection indoor / outdoor		mm ²	2x1,5 or 2,5	2x1,5 or 2,5	2x1,5 or 2,5
Air flow	Cool / Heat	m ³ /min	73,0/73,0	82,0/80,0	84,0/82,0
Sound pressure	Cool / Heat (Hi)	dB(A)	52/52	55/55	56/56
Sound power	Cool / Heat (Hi)	dB(A)	70/70	73/73	74/74
Dimension	H x W x D	mm	996 x 980 x 370	996 x 980 x 370	996 x 980 x 370
Net weight		kg	83	87	87
	Liquid	Inch (mm)	3/8 (9,52)	3/8 (9,52)	3/8 (9,52)
Piping diameter	Gas	Inch (mm)	5/8 (15,88)	5/8 (15,88)	5/8 (15,88)
	Min - Max	m	5 - 50	5 - 50	5 - 50
Elevation difference (in / out) ²⁾	Max	m	15/30	15/30	15/30
Pre-charged pipe length		m	30	30	30
Additional gas amount		g/m	45	45	45
Refrigerant (R32) / CO ₂ Eq.		kg / T	2,4/1,62	2,8/1,89	2,8/1,89
Operating range	Cool Min ~ Max	°C	-10 ~ +43	-10 ~ +43	-10 ~ +43
	Heat Min ~ Max	°C	-15 ~ 24	-15 ~ 24	-15 ~ 24

1) With 4 way 90x90 cassette. 2) Outdoor unit located lower / outdoor unit located higher.

Compatible indoor units for multi combinations

Optional:

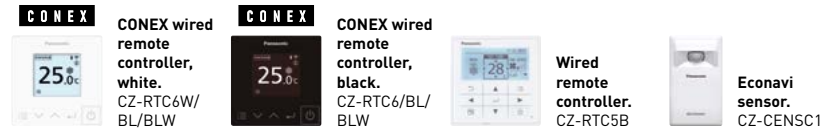

PANASONIC AC SMART CLOUD and AC SERVICE CLOUD: Optional.



Wall-mounted	Indoor unit	Cooling capacity	Heating capacity	Dimension	Sound pressure ¹⁾	Air flow ²⁾
		kW	kW	HxWxD mm	Hi / Med / Lo dB(A)	Hi / Med / Lo m ³ /min
3,6 - 5,0 kW	S-3650PK3E	3,6 - 5,0	4,0 - 5,6	302 x 1120 x 236	35/31/27 - 40/36/32	13,0/11,0/9,0 - 16,0/13,5/11,0
6,0 - 7,1 kW	S-6010PK3E	6,1 - 7,1	7,0 - 8,0	302 x 1120 x 236	47/44/40 - 47/44/40	20,0/17,5/14,5 - 20,0/17,5/14,5
10,0 kW	S-6010PK3E	9,5	9,5	302 x 1120 x 236	49/45/41	22,0/18,5/15,0



Panel (sold separately). CZ-KPY4

PANASONIC AC SMART CLOUD and AC SERVICE CLOUD: Optional.



4 way 60x60 cassette	Indoor unit (panel CZ-KPY4)	Cooling capacity	Heating capacity	Dimension indoor / panel	Sound pressure ¹⁾	Air flow ²⁾
		kW	kW	HxWxD mm	Hi / Med / Lo dB(A)	Hi / Med / Lo m ³ /min
2,5 kW	S-25PY3E	2,5	3,2	243 x 575 x 575 / 30 x 625 x 625	31/28/25	8,5/7,0/6,0
3,6 kW	S-36PY3E	3,6	4,0	243 x 575 x 575 / 30 x 625 x 625	34/30/25	9,5/7,5/6,0
5,0 kW	S-50PY3E	5,0	5,6	243 x 575 x 575 / 30 x 625 x 625	39/34/27	12,0/9,5/6,5
6,0 kW	S-60PY3E	6,0	7,0	243 x 575 x 575 / 30 x 625 x 625	43/37/31	14,0/10,5/8,0



PANASONIC AC SMART CLOUD and AC SERVICE CLOUD: Optional.



4 way 90x90 cassette	Indoor unit (panels CZ-KPU3W/3AW)	Cooling capacity	Heating capacity	Dimension indoor / panel	Sound pressure ¹⁾	Air flow ²⁾
		kW	kW	HxWxD mm	Hi / Med / Lo dB(A)	Hi / Med / Lo m ³ /min
3,6 - 5,0 kW	S-3650PU3E	3,6 - 5,0	4,0 - 5,6	256 x 840 x 840 / 33,5 x 950 x 950	30/28/27 - 32/29/27	14,5/13,0/11,5 - 16,5/13,5/11,5
6,0 - 7,1 kW	S-6071PU3E	6,0 - 7,1	7,0 - 8,0	256 x 840 x 840 / 33,5 x 950 x 950	36/31/28 - 37/31/28	21,0/16,0/13,0 - 22,0/16,0/13,0
10,0 - 12,5 kW	S-1014PU3E	10,0 - 12,5	11,2 - 14,0	319 x 840 x 840 / 33,5 x 950 x 950	45/38/32 - 46/39/33	36,0/26,0/18,0 - 37,0/27,0/19,0
14,0 kW	S-1014PU3E	14,0	16,0	319 x 840 x 840 / 33,5 x 950 x 950	47/40/34	38,0/29,0/20,0



PANASONIC AC SMART CLOUD and AC SERVICE CLOUD: Optional.



Ceiling	Indoor unit	Cooling capacity	Heating capacity	Dimension	Sound pressure ¹⁾	Air flow ²⁾
		kW	kW	HxWxD mm	Hi / Med / Lo dB(A)	Hi / Med / Lo m ³ /min
3,6 - 5,0 kW	S-3650PT3E	3,5 - 5,0	4,0 - 5,6	235 x 960 x 690	36/32/28 - 37/33/28	14,0/12,0/10,5 - 15,0/12,5/10,5
6,0 - 7,1 kW	S-6071PT3E	6,0 - 6,8	7,0 - 8,0	235 x 1000 x 690	38/34/29 - 39/35/30	20,0/17,0/14,5 - 21,0/18,0/15,5
10,0 - 12,5 kW	S-1014PT3E	9,5 - 12,1	11,2 - 14,0	235 x 1590 x 690	42/37/34 - 46/40/35	30,0/25,0/23,0 - 34,0/28,0/24,0
14,0 kW	S-1014PT3E	13,4	16,0	235 x 1590 x 690	47/41/36	35,0/29,0/25,0



PANASONIC AC SMART CLOUD and AC SERVICE CLOUD: Optional.







Adaptive ducted unit	Indoor unit	Cooling capacity	Heating capacity	Dimension	External static pressure	Sound pressure ¹⁾	Air flow ²⁾
		kW	kW	HxWxD mm	Nominal (Min - Max) Pa	Hi / Med / Lo dB(A)	Hi / Med / Lo m ³ /min
3,6 - 5,0 kW	S-3650PF3E	3,6 - 5,0	4,0 - 5,6	250 x 800 x 730	30(10 - 150) - 30(10 - 150)	30/27/22 - 34/30/25	14,0/13,0/10,0 - 16,0/15,0/12,0
6,0 - 7,1 kW	S-6071PF3E	5,7 - 6,8	7,0 - 7,5	250 x 1000 x 730	30(10 - 150) - 30(10 - 150)	30/26/23 - 30/26/23	21,0/19,0/15,0 - 21,0/19,0/15,0
10,0 - 12,5 kW	S-1014PF3E	9,5 - 12,1	10,8 - 13,5	250 x 1400 x 730	40(10 - 150) - 50(10 - 150)	33/29/25 - 35/31/27	32,0/26,0/21,0 - 34,0/29,0/23,0
14,0 kW	S-1014PF3E	13,4	15,5	250 x 1400 x 730	50(10 - 150)	39/35/29	36,0/32,0/25,0

* The data shown in these tables are based on PACI NX Elite combinations. 1) The sound pressure is measured in accordance with Eurovent 6/C/006-97 specification. 2) Factory setting.

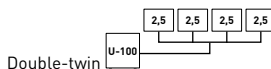
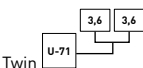
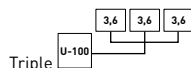

Rating conditions: Cooling indoor 27 °C DB / 19 °C WB. Cooling outdoor 35 °C DB / 24 °C WB. Heating indoor 20 °C DB. Heating outdoor 7 °C DB / 6 °C WB. (DB: Dry Bulb, WB: Wet Bulb). Specifications subject to change without notice. For detailed information about ErP / Energy Labelling, please visit our websites www.aircon.panasonic.eu or www.ptc.panasonic.eu.

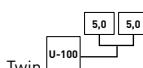
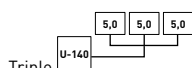
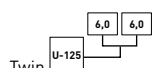
Simultaneous operation system combinations

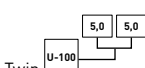
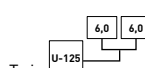

PACi NX Elite from 7,1 to 14,0 kW simultaneous operation system combinations - R32

Capacity	Indoor	Outdoor			
		7,1 kW	10,0 kW	12,5 kW	14,0 kW
2,5 kW	S-25PY3E				
3,6 kW	S-36PY3E S-3650PF3E S-3650PK3E S-3650PT3E S-3650PU3E				
4,5 kW	S-3650PF3E S-3650PK3E S-3650PT3E S-3650PU3E				
5,0 kW	S-50PY3E S-3650PF3E S-3650PK3E S-3650PT3E S-3650PU3E				
6,0 kW	S-60PY3E S-6071PF3E S-6010PK3E S-6071PT3E S-6071PU3E				
7,1 kW	S-6071PF3E S-6010PK3E S-6071PT3E S-6071PU3E				

PACi NX Standard from 10,0 to 14,0 kW simultaneous operation system combinations - R32

Capacity	Indoor	Outdoor		
		10,0 kW	12,5 kW	14,0 kW
5,0 kW	S-50PY3E S-3650PF3E S-3650PK3E S-3650PT3E S-3650PU3E			
6,0 kW	S-60PY3E S-6071PF3E S-6010PK3E S-6071PT3E S-6071PU3E			
7,1 kW	S-6071PF3E S-6010PK3E S-6071PT3E S-6071PU3E			

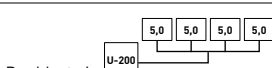
Big PACi NX and Big PACi from 20,0 to 25,0 kW simultaneous operation system combinations - R32

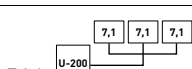
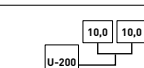
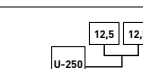
Capacity	Indoor	Outdoor	
		20,0 kW	25,0 kW
5,0 kW	S-3650PF3E* S-3650PU3E		
6,0 kW	S-6071PF3E* S-6071PU3E		
7,1 kW	S-6071PF3E* S-6071PU3E		
10,0 kW	S-1014PF3E* S-1014PU3E		
12,5 kW	S-1014PF3E* S-1014PU3E		

* Available with Big PACi NX (PZH4).

Refrigerant piping arrangements

Single

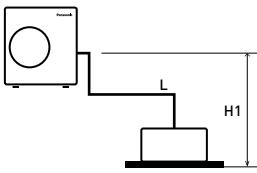

Twin

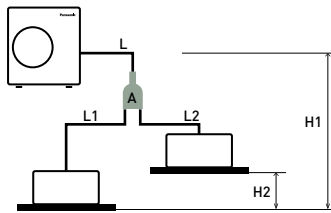

Triple

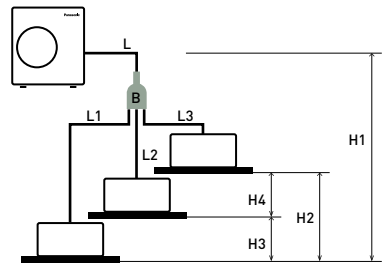

Double-twin

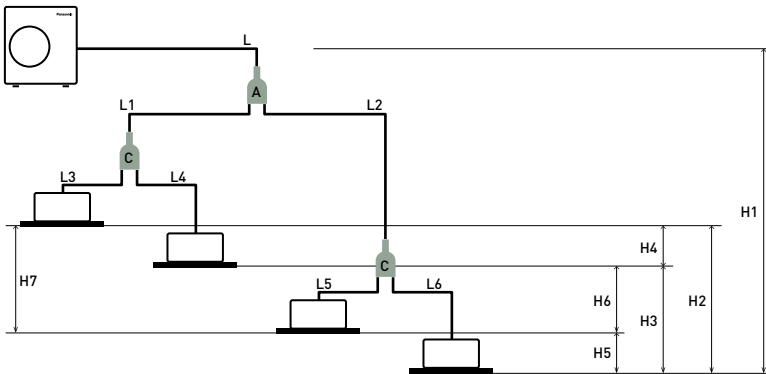

PACi NX Elite twin, triple and double-twin system from 7,1 to 14,0 kW

Joint distribution (sold separately)

A= CZ-P224BK2BM

B= CZ-P3 HPC2BM

C= CZ-P224BK2BM

PACi NX Standard twin system from 10,0 to 14,0 kW

Joint distribution (sold separately)

A= CZ-P224BK2BM

PACi Elite twin, triple and double-twin system from 20,0 to 25,0 kW

Joint distribution (sold separately)

A= CZ-P680BK2BM

B= CZ-P3 HPC2BM

C= CZ-P224BK2BM

Twin System	PACi NX Standard single and twin system from 7,1 to 14,0 kW				PACi NX Elite and PACi Elite twin, triple and double-twin system from 7,1 to 25 kW					
	Indoor unit combinations (see examples above)		Equivalent lengths and height differences (m) for outdoor unit sizes...		Indoor unit combinations (see examples above)				Equivalent lengths and height differences (m) for outdoor unit sizes from 7,1 to 14,0 kW	Equivalent lengths and height differences (m) for outdoor unit sizes from 20,0 to 25,0 kW
	Single	Twin			Single	Twin	Triple	Double-Twin		
Total pipe length	L	L + L1 + L2	≤ 50 m		L	L + L1 + L2	L + L1 + L2 + L3	L + L1 + L2 + L3 + L4 + L5 + L6	U-60/U-71: ≤ 50 m U-100/125/140: ≤ 75 m	U-200: ≤ 100 m U-250: ≤ 80 m
Maximum pipe length from outdoor unit to most distant indoor unit	-	-	-		-	L + L1 or L + L2	L + L1 or L + L2 or L + L3	L + L1 + L3 or L + L1 + L4 or L + L2 + L5 or L + L2 + L6	-	U-200: 90 m U-250: 60 m
Maximum branch pipe length	-	L1 L2	≤ 15		-	L1 or L2	L1 or L2 or L3	L1 + L3 or L1 + L4 or L2 + L5 or L2 + L6	≤ 15 m	≤ 20 m
Maximum branch pipe length differences	-	L1 > L2 L1 - L2	≤ 10		-	L1 > L2; L1 - L2	L1 > L2 > L3: L1 - L2 L2 - L3 L1 - L3	L2 + L6 (Max.) L1 + L3 (Min.): (L2 + L6) - (L1 + L3)	≤ 10 m	≤ 10 m
Maximum pipe length differences after first branch (Double-Twin)	-	-	-		-	-	-	L2 > L1: L2 - L1	≤ 10 m	≤ 10 m
Maximum pipe length differences after second branch (Double-Twin)	-	-	-		-	-	-	L4 > L3: L4 - L3 L6 > L5: L6 - L5	≤ 10 m	≤ 10 m
Height difference (outdoor unit located higher)	H1	H1	≤ 30		H1	H1	H1	H1	≤ 30 m	≤ 30 m
Height difference (outdoor unit located lower)	H1	H1	≤ 15		H1	H1	H1	H1	≤ 15 m	≤ 15 m
Height difference between indoor units	-	H2	≤ 0,5		-	H2	H2 or H3 or H4	H2 or H3 or H4 or H5 or H6	≤ 0,5 m	≤ 0,5 m

Twin System	PACi NX Standard single and twin system from 7,1 to 14,0 kW				PACi NX Elite twin, triple and double-twin system from 7,1 to 14,0 kW						Big PACi NX twin, triple and double-twin system from 20,0 to 25,0 kW				
	Outdoor unit main piping diameter (L)		Indoor unit connection tube (L1, L2)		Outdoor unit main piping diameter (L)	Indoor unit connection piping diameter (L1, L2, L3, L4) (mm)					Outdoor unit main piping diameter (L) (mm)	Double-Twin distribution pipe (L1, L2) ¹⁾	Indoor unit connection piping diameter ²⁾		
Unit type capacity	100	125	50	60	71 - 140	36	45	50	60	71	200	250	100 - 125	50	60 - 125
Liquid (mm)	Ø 9,52	Ø 12,70	Ø 6,35	Ø 9,52	Ø 9,52	Ø 6,35	Ø 6,35	Ø 6,35	Ø 9,52	Ø 9,52	Ø 12,70	Ø 12,70	Ø 9,52	Ø 6,35	Ø 9,52
Gas (mm)	Ø 15,88	Ø 15,88	Ø 12,70	Ø 15,88	Ø 15,88	Ø 12,70	Ø 12,70	Ø 12,70	Ø 15,88	Ø 15,88	Ø 22,22	Ø 22,22	Ø 15,88	Ø 12,70	Ø 15,88
Additional gas amount (g/m)	50	50	20	50	50	20	20	20	50	50	60	80	40	20	40

1) Total capacity of indoor unit connected after the branch. 2) 4 way cassette type.

Make additional charges by adding up tube length in an order of main tube (L) > branch tube (L1 > L2 > L3 wide diameter) and then selecting the amount of refrigerant corresponding to the remaining (after charge-less tube length: 30 m) liquid tube diameter and tube length from the above table.

Panasonic PACi with Water Heat Exchanger for chilled and hot water production

Introducing a highly-efficient Water Heat Exchanger for PACi Series. This ground-breaking product provides further possibilities by adding hydronic options.

Water outlet temperature:
Cooling: 5 ~ 15 °C
Heating: 30 ~ 55 °C



Highly-efficient Water Heat Exchanger for PACi Series.

System example.

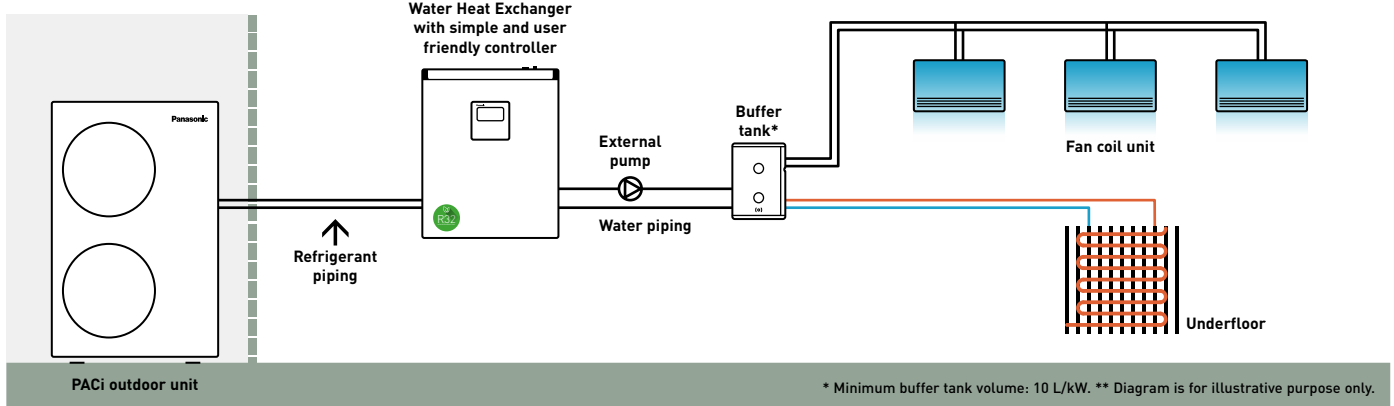

1 Cost saving solution

- A+++ Energy efficiency class (scale from A+++ to D)
- Cost effective water projects thanks to lower cost for PACi compared to VRF
- Reducing the amount of HFC refrigeration in the project

2 Flexible and space saving system

- 2 installation possibilities (wall-mounted / floor-standing)
- Compact, lightweight unit design, only 27 kg

3 Easy installation, maintenance

- Quick mounting process
- Flow switch kit is included as a standard
- Direct access to electrical box
- Operation down to -20 °C ambient without the need for glycol

Flexible and space saving system

Compact and light unit.

- Only 205 mm depth fits within a limited space
- Lightweight design at only 27 kg, makes it easy to maneuver and position
- Maximum total refrigerant piping length: 90 m*

* 90 m for PAW-200W5APAC-1.

2 installation options.

- Wall-mounted and floor-standing installation options are available. Free-up floor space by using the wall-mounted installation
- Quick mounting process with its lightweight compact design
Make fixing holes > Fix 2 screws > Hang the unit > Finish

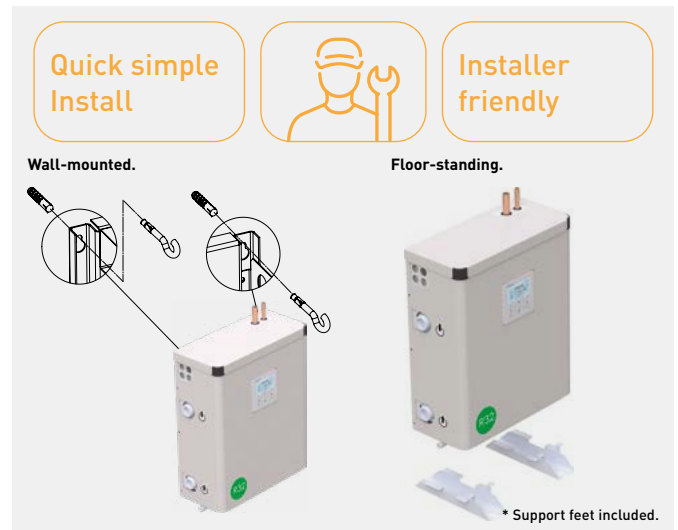
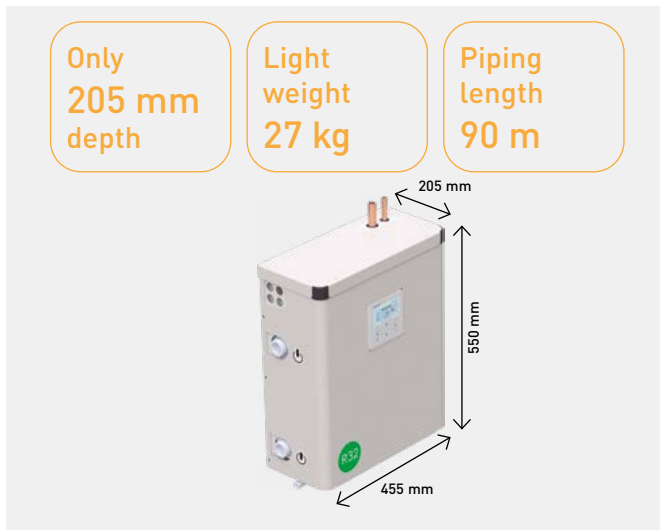

Foodchain/Small office application

- Fulfilling R32 refrigerant needs to follow environmental perspective, Company policy
- Hydraulic system to reduce total amount of HFC refrigeration
- Water solution to substitute electric heating system

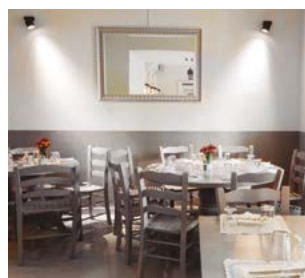

Foodchain.

Residential/Commercial retail application

- Water solution to substitute existing boiler system
- For heating projects with longer than 50 m piping



Commercial retail.

PACi Water Heat Exchanger (WHE) is the ideal solution for residential and commercial applications; the investment costs can be amortised in a short period.

Easy maintenance operation from two points of access

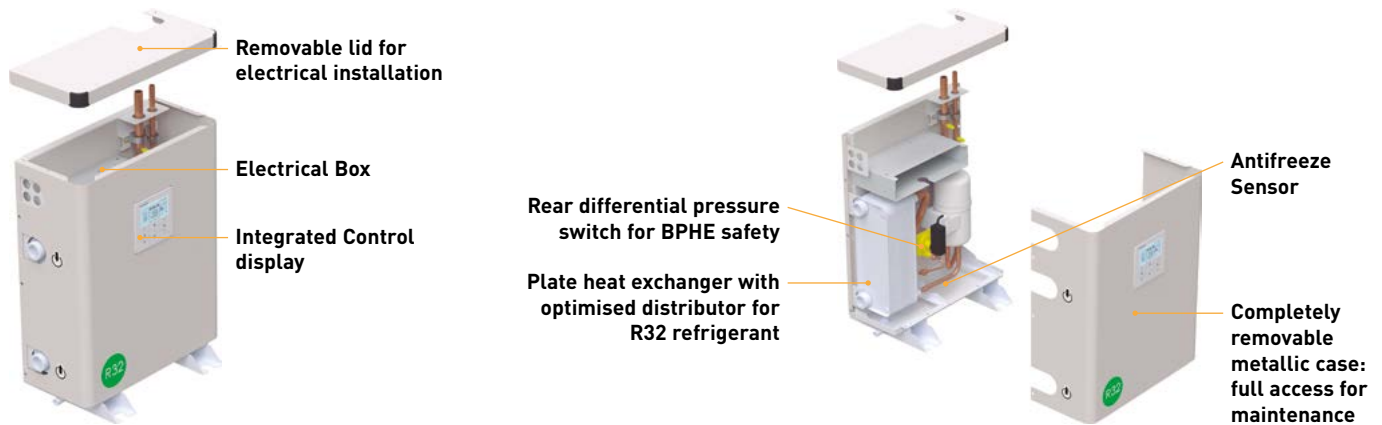

Integrated cascade control as standard for maximum ease and flexibility

Built-in cascade control for 2 units.

The control of 2 refrigerant systems can be combined together in a cascade. This option is included in the standard scope of delivery on the WHE. It is activated using the one of the CZ-RTC5B remote controllers on the units as master. Rotation and Backup operation modes can be selected.

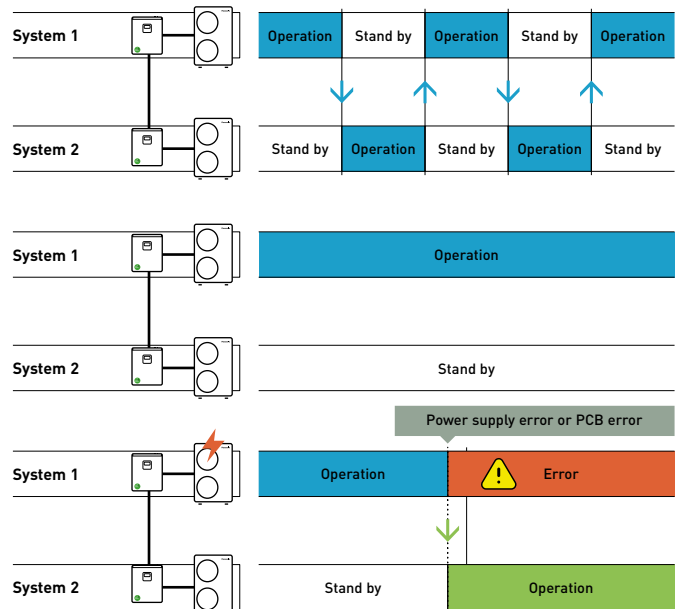
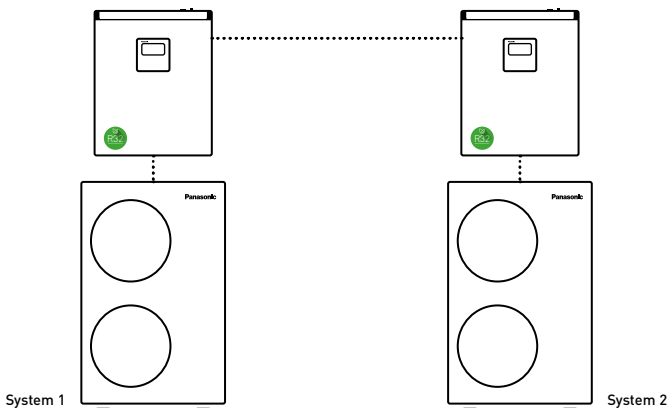

* One of built-in controllers should be deactivated.

PACi Water Heat Exchanger can be connected as a cascade with up to 4 groups of 8 units, reaching up to 800 kW

Optional PAW-PACR4 cascade controller allows up to four groups, with each group containing between 1-8 units, to be combined into a cascade for failure substitution or temperature assist.

- Maximum 4 groups (up to 8 units per group)
- Rotation
- Failure substitution
- Temperature assist
- Operation output signal
- Alarm output signal

Example: 4 x groups.
 Maximum available capacity per group: 8 x 25 kW = 200 kW.
 Total maximum available capacity: 4 x 200 kW = 800 kW.

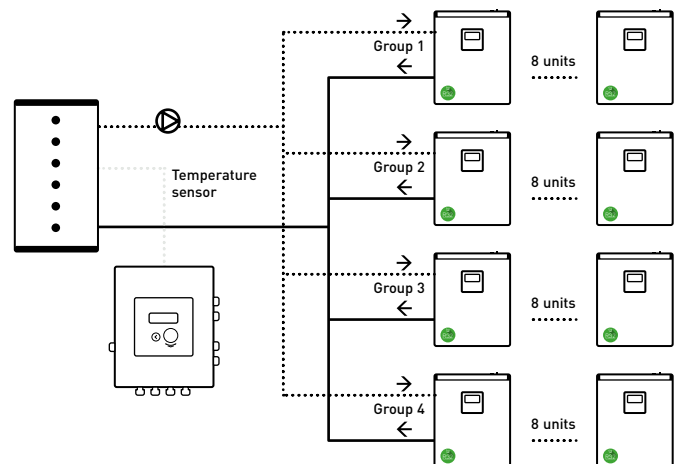

PACi with Water Heat Exchanger for chilled and hot water production

Constant 55 °C flow available.

Short-term investment recovery.

PACi Water Heat Exchanger is ideal for small offices and retails. The investment costs can be amortised within a very short period. This solution allows investors and operators to save money.



Water Heat Exchanger			PAW-200W5APAC-1	PAW-250W5APAC-1
Cooling capacity ¹⁾		kW	20,0	26,0
EER ¹⁾		W/W	3,03	2,89
Heating capacity ²⁾		kW	26,5	31,6
COP ²⁾		W/W	3,34	3,31
Energy efficiency class (Scale A+++ to D) ³⁾	35 °C (low temperature HP)		A+++	A+++
	55 °C (low temperature HP)		A+	A+
$\eta_{s,h}$ (LOT1) ⁴⁾		%	178	178
Dimension	H x W x D	mm	550 x 455 x 205	550 x 455 x 205
Net weight		kg	27	27
Water pipe connector		Inch	Male Thread 1 1/4	Male Thread 1 1/4
Cooling water flow ($\Delta T=5$ K, 35 °C)		m ³ /h	3,45	4,30
Heating water flow ($\Delta T=5$ K, 35 °C)		m ³ /h	4,15	4,85
Flow switch			Included	Included
Water filter			Included	Included
Outdoor unit			U-200PZH2E8	U-250PZH2E8
Sound pressure	Cool / Heat (Hi)	dB(A)	59 / 61	59 / 63
Dimension	H x W x D	mm	1500 x 980 x 370	1500 x 980 x 370
Net weight		kg	117	128
Piping diameter	Liquid	Inch (mm)	3/8 (9,52)	1/2 (12,70)
	Gas	Inch (mm)	1 (25,40)	1 (25,40)
Pipe length range		m	5 ~ 90	5 ~ 60
Elevation difference (in / out)		m	30	30
Pre-charged pipe length		m	30	30
Additional gas amount		g/m	60	80
Water outlet temperature range	Cool Min ~ Max	°C	+5 ~ +15	+5 ~ +15
	Heat Min ~ Max	°C	+30 ~ +55	+30 ~ +55
Operating range	Cool Min ~ Max	°C	-15 ~ +46	-15 ~ +46
	Heat Min ~ Max	°C	-20 ~ +24	-20 ~ +24

1) Data refers to 7 °C leaving chilled water temperature and 35 °C ambient air temperature, according to EN14511 standard. 2) Data refers to 35 °C leaving warm water temperature and 7 °C ambient air temperature according to EN14511 standard. 3) Following COMMISSION REGULATION (EU) No 811/2013 for low-temperature heat pumps. Scale from A+++ to D. 4) Following COMMISSION REGULATION (EU) No 813/2013 for low-temperature heat pumps.

Professional solution

Water heat exchanger is compatible with R32 PACi.

Many air conditioning manufacturers are selling R32 systems and it is becoming the standard refrigerant for split type air conditioning, because R32 has a much lower global warming potential than R410A, and can also provide higher efficiency.

Quick installation with pre-assembled flow switch

The flow switches come pre-assembled with pipe fittings for ease of installation.

Operation down to -20 °C with no glycol as the heat exchanger is installed indoors.

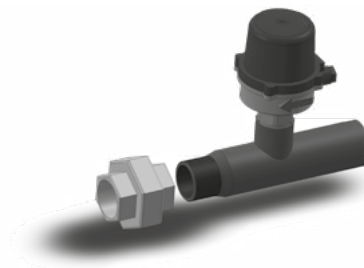

AHU connection kit PAH3M for PACi NX and PACi

CONEX Bluetooth® version (CZ-RTC6BL) is built-in.
Easy connection and set-up is possible via Bluetooth®.
0-10 V demand control.



PACi



PAW-280PAH3M-1			2,5 kW	3,6 kW	5,0 kW	6,0 kW	7,5 kW	10,0 kW	12,5 kW	14,0 kW	20,0 kW	25,0 kW
Dimension	HxWxD	mm	500 x 400 x 150	500 x 400 x 150	500 x 400 x 150	500 x 400 x 150	500 x 400 x 150	500 x 400 x 150	500 x 400 x 150	500 x 400 x 150	500 x 400 x 150	500 x 400 x 150
Net weight		kg	11,5	11,5	11,5	11,5	11,5	11,5	11,5	11,5	11,5	11,5
Piping diameter	Liquid	Inch (mm)	1/4 (6,35)	1/4 (6,35)	1/4 (6,35)	3/8 (9,52)	3/8 (9,52)	3/8 (9,52)	3/8 (9,52)	3/8 (9,52)	3/8 (9,52)	1/2 (12,70)
	Gas	Inch (mm)	1/2 (12,70)	1/2 (12,70)	1/2 (12,70)	5/8 (15,88)	5/8 (15,88)	5/8 (15,88)	5/8 (15,88)	5/8 (15,88)	1 (25,40)	1 (25,40)
Intake temperature of AHU connection kit	Cool Min ~ Max	°C DB	18 ~ 32	18 ~ 32	18 ~ 32	18 ~ 32	18 ~ 32	18 ~ 32	18 ~ 32	18 ~ 32	18 ~ 32	18 ~ 32
	Cool Min ~ Max	°C WB	14 ~ 25	14 ~ 25	14 ~ 25	14 ~ 25	14 ~ 25	14 ~ 25	14 ~ 25	14 ~ 25	—	—
	Heat Min ~ Max	°C	16 ~ 30	16 ~ 30	16 ~ 30	16 ~ 30	16 ~ 30	16 ~ 30	16 ~ 30	16 ~ 30	16 ~ 30	16 ~ 30
With PACi NX Elite												
Cooling capacity		kW	—	3,6	5,0	6,0	7,1	10,0	12,5	14,0	19,5	23,2
Heating capacity		kW	—	4,0	5,6	7,0	8,0	11,2	14,0	16,0	22,4	28,0
Air flow	Min / Max	m³/h	—	540/870	630/990	780/1320	780/1320	900/2160	1140/2280	1200/2400	2160/4320	2280/5040
Pipe length range		m	—	3 ~ 40	3 ~ 40	3 ~ 40	5 ~ 50	5 ~ 85	5 ~ 85	5 ~ 85	5 ~ 90	5 ~ 60
Elevation difference (in / out)	Max	m	—	30	30	30	30	30	30	30	30	30
Ambient temperature of outdoor unit	Cool Min ~ Max	°C	—	-15 ~ +46	-15 ~ +46	-15 ~ +46	-15 ~ +46	-20 ~ +48	-20 ~ +48	-20 ~ +48	-20 ~ +48	-20 ~ +48
	Heat Min ~ Max	°C	—	-20 ~ +24	-20 ~ +24	-20 ~ +24	-20 ~ +24	-20 ~ +24	-20 ~ +24	-20 ~ +24	-20 ~ +24	-20 ~ +24
With PACi NX Standard												
Cooling capacity		kW	2,5	3,6	5,0	6,0	7,1	10,0	12,5	14,0	—	—
Heating capacity		kW	3,2	4,0	5,0	6,0	7,1	10,0	12,5	14,0	—	—
Air flow	Min / Max	m³/h	360 / 570	540/870	630/990	780/1320	780/1320	900/2160	1140/2280	1200/2400	—	—
Pipe length range		m	3 ~ 15	3 ~ 15	3 ~ 20	3 ~ 40	3 ~ 40	5 ~ 50	5 ~ 50	5 ~ 50	—	—
Elevation difference (in / out)	Max	m	30	30	30	30	30	30	30	30	—	—
Ambient temperature of outdoor unit	Cool Min ~ Max	°C	-10 ~ +43	-10 ~ +43	-10 ~ +43	-10 ~ +43	-10 ~ +43	-10 ~ +43	-10 ~ +43	-10 ~ +43	—	—
	Heat Min ~ Max	°C	-15 ~ +24	-15 ~ +24	-15 ~ +24	-15 ~ +24	-15 ~ +24	-15 ~ +24	-15 ~ +24	-15 ~ +24	—	—

Control options

Control option 1.

- The system's control is simple: control of actual suction temperature vs. set point
- Control works in the same way as that of any indoor unit
- Fan signal issued by the PCB (OFF while defrosting, for instance)

Control option 2.

- System control by a 0-10 V control working from an external BMS that manages the set point for temperature or capacity. Enhances efficiency by adjusting capacity and enhances comfort as well
- All signals as standard

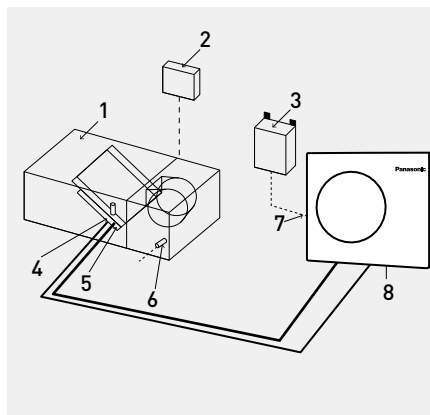

System and regulations. System overview.

- 1 | AHU equipment (field supplied)
- 2 | AHU system controller (field supplied)
- 3 | AHU connection kit controller box (with control PCB)
- 4 | Thermistor for gas pipe (E2)
- 5 | Thermistor for liquid pipe (E1)
- 6 | Thermistor for suction air
- 7 | Inter-unit wiring
- 8 | Outdoor unit

0-10 V control

With the 0-10 V demand control the capacity of the outdoor unit can be controlled by 20 steps.

Input voltage* [V]	0	1,0	1,5	2,0	2,5	3,0	3,5	4,0	4,5	5,0	5,5	6,0	6,5	7,0	7,5	8,0	8,5	9,0	9,5
Demand [% of nominal current]	No cut ¹⁾	40	45	50	55	60	65	70	75	80	85	90	95	100	105	110	115	120	No limit / Full capacity ²⁾
Indoor unit start / stop	Stop ¹⁾																		Start

1) No cut / stop: AHU system / indoor unit is completely switched OFF.

2) No limit: No restrictions applied by BMS to AHU system / indoor unit performance (equivalent to "full-load operation" of AHU system / indoor unit).

AHU connection kit.

PCB, power trans, terminal block.



Thermistor x2 (refrigerant: E1, E2).



Thermistor (air: TA; 1 sensor).



Wired remote controller. CZ-RTC6BL.



Optional controller.

Timer remote controller. CZ-RTC5B.



Electric air curtain

The Panasonic range of air curtains is designed for smooth operation and efficient performance. Air curtains produce a continuous stream of air blown from the top to the bottom of an open doorway and create a barrier that people and products can flow across, but air cannot.



			FY-3009U1	FY-3012U1	FY-3015U1
Width	mm		900	1200	1500
Voltage	V		220	220	220
Air flow	Hi / Lo	m ³ /h	1100/920	1400/1270	2000/1800
Consumption	Hi / Lo	W	76/70	94/85	131/110
Current	Hi / Lo	A	0,35/0,32	0,43/0,40	0,59/0,50
Air speed	Hi / Lo	m/s	10,50/8,50	9,50/8,00	10,50/9,50
Sound pressure	Hi / Lo	dB(A)	48,5/45,0	48,5/44,5	51,5/48,0
Dimension	HxWxD	mm	900x231,5x212	1200x231,5x212	1500x231,5x212
Net weight		kg	12,0	14,5	18,0

1 Designed to maximize performance
High air flow upgraded 145% compared to conventional model (in the case of FY-3009U1).

3 Easier installation and maintenance
Simple structure for easy installation and maintenance.

2 Comprehensive product line up
1,5 m wide model added in the line up.

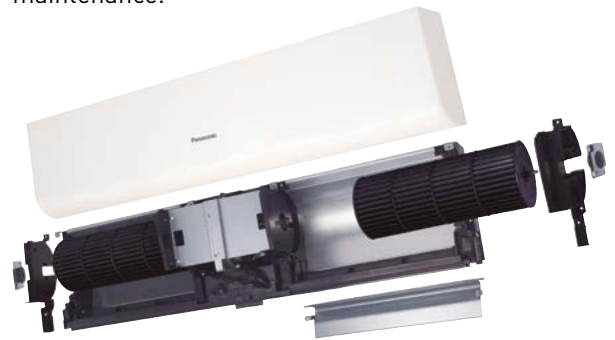

Air curtain with DX coil, connected to PACi NX and PACi

Comfort: Easy redirection of air flow by means of manual deflector.

Ease of use: Speed selector (high and low) on the unit itself.

Easy installation and maintenance: Easy installation / Compact dimensions improve installation and positioning / Easy cleaning of grid without opening of the unit.



Outdoor unit capacity			7,1 kW	10,0 kW	14,0 kW	20,0 kW
Air outlet height 2,7 m			PAW-10PAIRC-LS-1	PAW-15PAIRC-LS-1	PAW-20PAIRC-LS-1	PAW-25PAIRC-LS-1
Cooling capacity ¹⁾	Max	kW	6,1	9,7	13,0	17,0
Heating capacity ²⁾	Max	kW	7,9	12,0	15,0	19,0
Air flow	High	m ³ /h	1800	2700	3600	4500
Heat Exchanger	Volume	L	1,67	2,85	3,94	5,03
Electric consumption fan	230 V / 50 Hz	kW	0,30	0,50	0,60	0,80
Current	230 V / 50 Hz	A	2,10	3,10	4,10	5,10
Sound pressure ³⁾	Max	dB(A)	65	66	67	69
Air outlet height 3,0 m			PAW-10PAIRC-HS-1	PAW-15PAIRC-HS-1	PAW-20PAIRC-HS-1	PAW-25PAIRC-HS-1
Cooling capacity ¹⁾	Max	kW	9,1	13,0	19,5	23,7
Heating capacity ²⁾	Max	kW	11,8	15,8	23,6	27,6
Air flow	High	m ³ /h	2700	3600	5400	6300
Heat Exchanger	Volume	L	1,67	2,85	3,94	5,12
Electric consumption fan	230 V / 50 Hz	kW	0,75	1,00	1,50	1,75
Current	230 V / 50 Hz	A	4,10	5,50	8,20	9,60
Sound pressure ³⁾	Max	dB(A)	66	67	68	68
Common data						
Dimension ⁴⁾	HxWxD	mm	260 (+140) x 1000 x 460	260 (+140) x 1500 x 460	260 (+140) x 2000 x 460	260 (+140) x 2500 x 460
Net weight	Air outlet height 2,7 m	kg	50	65	80	95
	Air outlet height 3,0 m	kg	55	65	85	110
Fan type			EC	EC	EC	EC
Piping diameter	Liquid / Gas	Inch (mm)	3/8 (9,52) / 5/8 (15,88)	3/8 (9,52) / 3/4 (19,05)	3/8 (9,52) / 7/8 (22,22)	3/8 (9,52) / 7/8 (22,22)
Door width		m	1,0	1,5	2,0	2,5
Refrigerant			R32	R32	R32	R32

LS / PACi outdoor combination*	PACi Elite			PACi Standard		
	40 °C	35 °C	30 °C	40 °C	35 °C	30 °C
PAW-10PAIRC-LS-1	U-100	U-100	U-50	U-100	U-100	U-60
PAW-15PAIRC-LS-1	U-200	U-100	U-100	—	U-100	U-100
PAW-20PAIRC-LS-1	U-200	U-140	U-100	—	—	U-100
PAW-25PAIRC-LS-1	U-250	U-200	U-125	—	—	U-125

HS / PACi outdoor combination*	PACi Elite			PACi Standard		
	40 °C	35 °C	30 °C	40 °C	35 °C	30 °C
PAW-10PAIRC-HS-1	U-200	U-100	U-100	—	U-100	U-100
PAW-15PAIRC-HS-1	U-200	U-200	U-100	—	U-200	U-100
PAW-20PAIRC-HS-1	—	U-250	U-200	—	U-250	—
PAW-25PAIRC-HS-1	—	U-250	U-200	—	U-250	—

1) Cooling capacity DX coil, air temperature in / out +27 / +18 °C, R32 and R410. 2) Heating capacity condenser, air temperature in / out +20 / +33 °C, R32 and R410. In the case of lower outdoor temperatures, an outdoor model with higher capacity may be necessary. 3) Measured in distance up to 5,0 m, direction factor 2, absorbing surfaces 200 m², Min / Max air flow. 4) 140 mm is the height of an electrical box if it is installed on the top. * Available with PZH2 and PZ2. PZH3 and PZ3 will be compatible from Spring 2024.

Technical focus

- Now compatible with PACi NX Series
- Save up to 40% energy costs by use of the integrated EC fan technology (higher efficiency than conventional AC fan, soft start and longer motor duration)
- 4 length of air curtain LS and HS are available 1,0, 1,5, 2,0 and 2,5 m
- Installation height up to 3,0 m
- Outlet grilles can be adjusted in five positions, to suite different indoor and installation requirements
- Control with Panasonic remote control systems (optional)
- Direct integration to BMS via optional Panasonic interfaces
- Drip tray included in all DX air curtains
- Drain pump included

How does it work?

Stale air from the room is taken in and ejected near the door. This creates a 'roll of air' that shields the door area, mixing with the colder incoming air. It then turns away from the door, back into the room and toward the intake screen, where it is partly drawn in again. This flow of air helps to create a barrier for heat loss yet at the same time refreshes room air

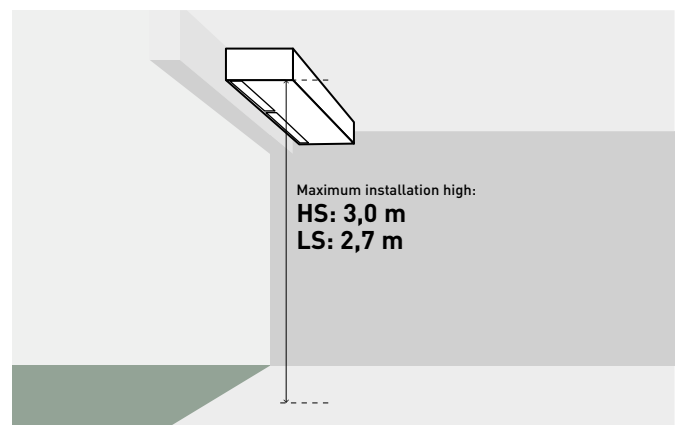

Ceiling mounted air-e nanoe X Generator

- nanoe™ X technology
(Generator Mark 1: 4,8 trillion hydroxyl radicals/sec)
- Silent operation. Whisper quiet at 25,5 dB(A)*
- Low power consumption 4 W
- Easy installation
- Compact and modern design

* 230 V.

air-e™



Model	FV-15CSD1G				
Power supply	Voltage	V	220	230	240
	Frequency	Hz	50	50	50
Air flow	m³/h		15	16	17
	CFM		8,8	9,4	10,0
Consumption	W		4	4	4
Sound pressure	dB(A)		23,5	25,5	27,0
Net weight	kg			1,1	

* The value of air volume, power consumption and noise are specified at static pressure 0 Pa. The value of air volume is the mean value and a tolerance of +-10% is allowed. The value of noise level is a weighted average sound pressure level, the mean value is measured by Panasonic. A tolerance of +3 dB/-7 dB is allowed. The noise is measure at 1 m apart from the left, the front and below of the tested product. Conditions of generating nanoe™ X: room temperature: about 5 °C ~ 40 °C (dew point temperature more than 2 °C), relative humidity: about 30% ~ 85%. nanoe™ X is generated using the air in the room, and its amount is subject to the temperature and humidity in the air.

One device is suitable for around 20 m² (with a ceiling height 3 m)

Ex. 3 air-e devices are required for the room size 60 m².

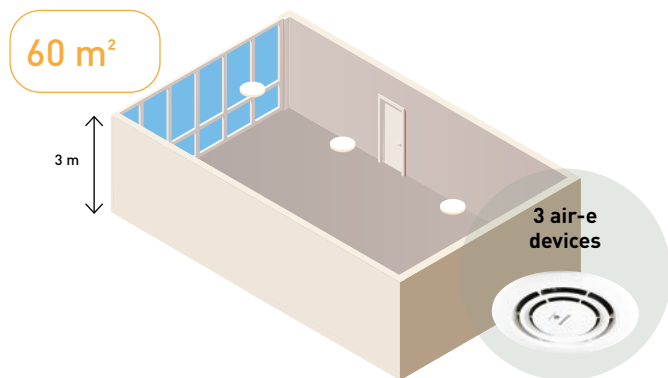

Concentration simulator is ready

See how nanoe™ X fills space.



The air-e is a stand alone device which is an easy and simple choice to improve indoor air quality. It can be easily installed to various commercial projects including refurbishments.

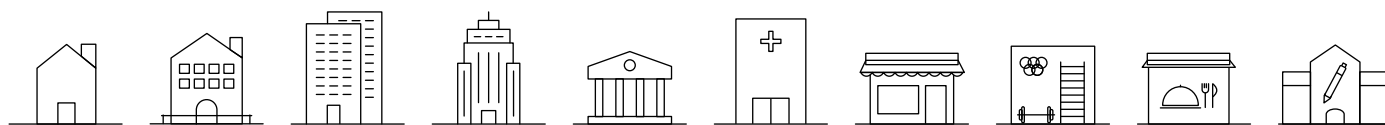

The tested effects of nanoe™ X

Bacteria and viruses.

SARS-CoV-2: 99,9% % inhibited ¹⁾

Influenza virus H1N1 subtype: 99,9 % inhibited ²⁾

Odour.

nanoe X Generator can reduce cigarette smoke odour intensity by 2,4 levels in 12 minutes.

- 1) Novel coronavirus [SARS-CoV-2] > [Test organization] Texcell [France] [Test subject] Adhered novel coronavirus [SARS-CoV-2] [Test volume] 45 L enclosed box [Test result] Inhibited 99,9% in 2 hours [Test report] 1140-01 A1.
- 2) Adhered virus [Influenza virus H1N1 subtype] > [Test organization] Kitasato Research Center for Environmental Science [Test subject] Influenza virus [H1N1 subtype] [Test volume] 1000 L enclosed box [Test result] Inhibited 99,9% in 2 hours [Test report] 21_0084_1.
- 3) Deodorisation effect for adhering odour [cigarette smoke] > [Test organization] Panasonic Product Analysis Center [Test subject] Adhered cigarette smoke odour [Test volume] Approx. 24 m³ laboratory [Test result] Odour intensity reduced 2,4 levels in 0,2 hours [Test report] 4AA33-160615-N04.

Performance of nanoe™ X might differ in real life environment and is only expected in the same room as where the unit is placed. The nanoe™ X performance varies depending on the room size, environment and usage and it may take several hours to reach the full effect. nanoe™ X is not a medical device.

Deodorisation effect for adhering odour (cigarette smoke) ³⁾

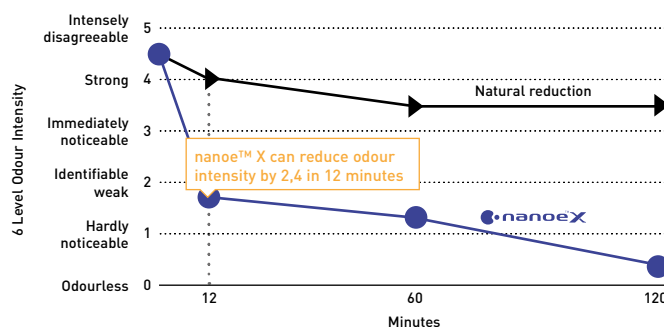

For further details and validation data, please refer to the following website.



R22 Renewal. Fast, easy to install and cost effective

An important drive to further reduce the potential damage to our ozone.

It is often said that legislation is ruling our lives but sometimes it is there to help save lives. R22 phase out can be described as one of these and from Jan 1st 2010 the use of Virgin R22 refrigerant was banned within the European Union.



Panasonic is doing its part.

We at Panasonic are also doing our part – recognising that all finances are under pressure at the moment. Panasonic has developed a clean and cost effective solution to enable this latest legislation to offer less financial impact on your business.

The Panasonic renewal system allows good quality existing R22 or R410A pipe work to be re-used whilst installing high efficiency R32 systems.

By bringing a simple solution to the problem Panasonic can renew all Split Systems and PACi systems; and depending upon certain restrictions we don't even limit the manufacturer's equipment we are replacing.

By installing a high efficiency Panasonic R32 system you can benefit from around 30% running cost saving compared to the R22 system.

Yes...

1. Check the capacity of the system you wish to replace
2. Select from the Panasonic range the best system to replace it with
3. Follow the procedure detailed in the brochure and technical data

Simple...

Why renewal?

Unique R22 Renewal from Panasonic: Fast, easy to install and cost effective.

- Panasonic refrigerant oil doesn't react to the most common oil types used in air-conditioning systems. This ensures the mix of oil does not damage the units. Therefore installations are easier

- All Panasonic PACi units can be installed in R22 pipings, no specific models are available
- Up to 33 Bar! When there is any doubt about the strength of the piping, the maximum working pressure can be reduced to 33 Bar with a setting in the software of the outdoor unit

Reuse of existing piping (renewal design and installation)

Notes on reuse of existing refrigerant piping.

It is possible for each series of PZH and PZ series outdoor unit to reuse the existing refrigerant piping without cleaning when obtained under certain conditions. Make sure that the requirements under the section "Notes on reuse of existing refrigerant piping", "Measurement procedure for renewal" and "Refrigerant piping size and allowable piping length" will be satisfied in order to carry out.

Also, check the items with regard to section "Safety" and "Cleaning".

1. Prerequisite.

- If the refrigerant used for the existing unit is other than R22, R407C and R410A / R32, the existing refrigerant piping cannot be used.
- If the existing unit has another use than air conditioning, then existing refrigerant piping cannot be used.

2. Safety.

- If there is a hollow, crack or corrosion on the piping, make sure to install new piping.
- If the existing piping is other than capable of reuse of piping as shown in the flowchart, make sure to install new piping.
- In case of multiple operation, use our genuine branch piping for refrigerant R32.

A local supplier shall assume responsibility for the defects and hollows on the reuse of existing piping surface and recognition of reliability of the piping strength. There is no guarantee that we take responsibility for such damages.

The operational pressure of the refrigerant R32 becomes higher compared to R22 or R410A. In the worst case, a lack of compressive strength may lead to piping explosion.

3. Cleaning.

- When the refrigerant oil used for the existing unit is other than the listed below, make sure to install new piping or wash it thoroughly before reusing it.
[Mineral Oil] SUNISO, FIORE S, MS
[Synthesized oil] alkyl benzene oil (HAB, parallel freeze), ester oil, ether oil (PVE only)

If the existing unit is GHP type, it is necessary to wash the piping thoroughly.

- If the existing pipes in the outdoor and indoor units remain disconnected, make sure to install a new piping or wash it thoroughly before reusing it.
- If the discoloured oil or residue remains in the existing piping, make sure to install a new piping or wash it thoroughly before reusing it. See "Deterioration Criteria for Refrigerant Oil" in table 3.
- If the compressor of the existing air conditioner has a failure history, make sure to install a new piping or wash it through thoroughly before reusing it.

When reusing the existing piping as it is without removing dirt and dust, inadequate piping could result a renewal appliance in failure.



Notes on renewal for simultaneous operation of multiple units.

Only main pipe is applicable for using the different diameter size.

In case of different diameter size for the branch pipes, a new installation work for a standard size is necessary. Be sure to use our genuine branch piping for refrigerant R32.

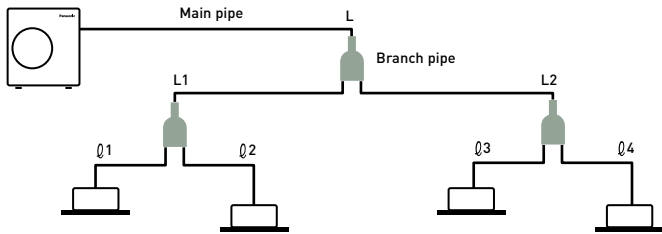

Notes on renewal for simultaneous operation of multiple units

Capacity class	Standard liquid pipe size	Standard gas pipe size
Type 50	∅ 6,35	∅ 12,70
Type from 60 to 140	∅ 9,52	∅ 15,88
Type 200	∅ 12,70	∅ 22,22
Type 250	∅ 12,70	∅ 22,22

- Only the main pipe L can be used among different diameter's existing piping
- Installation work as a standard size is capable for L1, L2, Q1 - Q4 piping
- Be sure to use our genuine branch piping for refrigerant R32

1. In case of single unit:
It is not necessary to charge with additional refrigerant until the chargeless pipe length in the table 2. If the pipe length is exceeding the charge less pipe length, charge with additional refrigerant amount per 1 m according to the equivalent length.
2. In case of simultaneous operation of multiple units:
Calculate the refrigerant charging amount according to the calculating method of the standard piping diameter. As to the additional refrigerant charging amount per 1 m, refer to the additional amount in the table 2.

Measurement procedure for renewal

Observe the following procedure when reusing the existing piping or carrying out renewal installation work. Flowchart of existing piping measures criteria for PZH and PZ series outdoor unit.

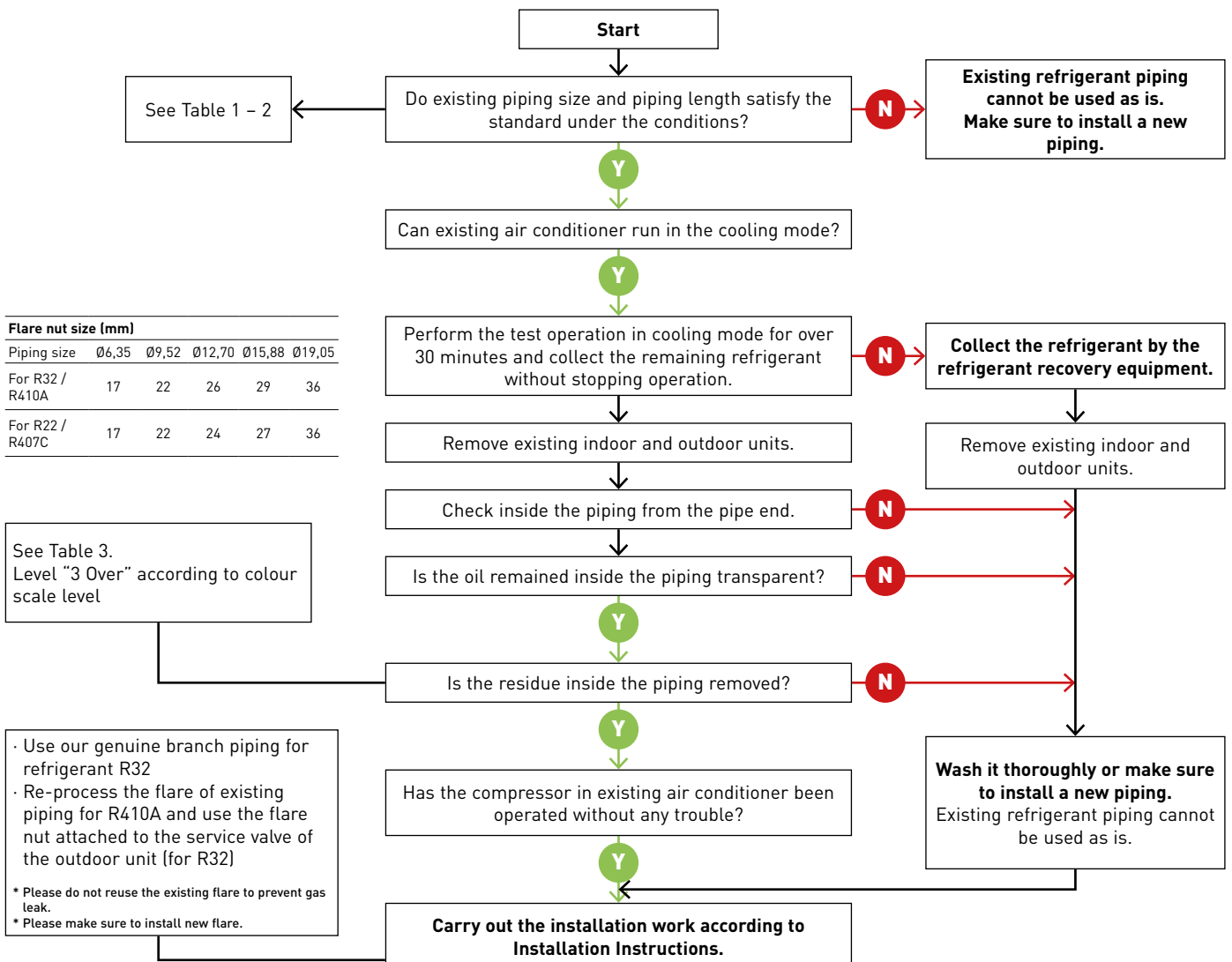

Refrigerant piping size and allowable piping length.

Check if reuse of existing refrigerant piping is possible based on the following chart.

The standards other than this one (difference of elevation, etc.) are identical to the requirements of ordinary refrigerant piping.

Table 1 - Reusable existing piping (mm)

Material	0								1/2 H, H*	
External diameter	Ø6,35	Ø9,52	Ø12,70	Ø15,88	Ø19,05	Ø22,22	Ø25,40	Ø28,58		
Thickness	0,80	0,80	0,80	1,00	1,00	1,00	1,00	1,00	1,00	1,00

* It is impossible to reuse the size of Ø19,05, Ø22,22, Ø25,4 and Ø28,58 for material O. Change to material 1/2H or material H.

Table 2 - 1 Refrigerant piping size: 2,5 - 14,0 kW type (mm)

Liquid pipe			Ø6,35				Ø9,52			Ø12,70	
Gas pipe			Ø9,52	Ø12,70	Ø15,88	Ø12,70	Ø15,88	Ø19,05	Ø15,88	Ø19,05	
PZH3	Type 36 ~ 60	Additional gas 15 g/m	✗	Standard 40 m (30 m)	✗	✗	✗	✗	✗	✗	✗
	Type 25		Tentative data								
PZ3	Type 36	Additional gas 10 g/m	✗	Standard 15 m (7,5 m)	✗	✗	✗	✗	✗	✗	✗
	Type 50	Additional gas 15 g/m	✗	Standard 20 m (7,5 m)	✗	✗	✗	✗	✗	✗	✗
	Type 60	Additional gas 15 g/m	✗	Standard 30 m (7,5 m)	✗	✗	✗	✗	✗	✗	✗
	Type 71	Additional gas 17 g/m	✗	✗	Standard 40 m (10 m)	✗	✗	✗	✗	✗	✗

Liquid pipe			Ø6,35				Ø9,52			Ø12,70	
Gas pipe			Ø9,52	Ø12,70	Ø15,88	Ø12,70	Ø15,88	Ø19,05	Ø15,88	Ø19,05	
PZH3	Type 71		✗	□ 10 m (10 m)	□ 10 m (10 m)	▽ 30 m (30 m)	Standard 50 m (30 m)	✗	□ 25 m (15 m)	□ 35 m (15 m)	✗
	Type 100 - 140		✗	✗	✗	✗	Standard 85 m (30 m)	⊙ 85 m (30 m)	□ 35 m (15 m)	□ 35 m (15 m)	
Additional gas			20 g/m				45 g/m			80 g/m	
PZ3	Type 100 - 140		✗	✗	✗	✗	Standard 50 m (30 m)	⊙ 50 m (30 m)	□ 25 m (15 m)	□ 25 m (15 m)	
Additional gas			20 g/m				45 g/m			80 g/m	
PZH2	Type 50		✗	Standard 40 m (30 m)	⊙ 40 m (30 m)	□ 20 m (15 m)	□ 20 m (15 m)	✗	✗	✗	✗
PZ2	Type 60 ~ 71		✗	▽ 10 m (10 m)	□ 10 m (10 m)	▽ 30 m (20 m)	Standard 50 m (20 m)	✗	□ 25 m (10 m)	□ 35 m (15 m)	✗
Additional refrigerant charging amount per 1 m			20 g/m				40 g/m			80 g/m	
PZH2	Type 60 ~ 71		✗	▽ 10 m (10 m)	□ 10 m (10 m)	▽ 30 m (30 m)	Standard 50 m (30 m)	✗	□ 25 m (15 m)	□ 35 m (15 m)	✗
	Type 100 - 140		✗	✗	✗	✗	Standard 75 m (30 m)	⊙ 75 m (30 m)	□ 35 m (15 m)	□ 35 m (15 m)	
PZ2	Type 100 - 140		✗	✗	✗	✗	Standard 50 m (30 m)	⊙ 50 m (30 m)	□ 25 m (15 m)	□ 25 m (15 m)	
Additional refrigerant charging amount per 1 m			20 g/m				50 g/m			80 g/m	

How to see table definition (example):

In case of type 71, standard size is liquid pipe Ø9,52 / gas pipe Ø15,88.

There is a limitation to liquid pipe Ø9,52 / gas pipe Ø12,70 and to liquid pipe Ø12,70 / gas pipe Ø15,88.

However, they are applicable for different diameter's pipes.

Table 2 - 2 Refrigerant piping size: 20,0 - 25,0 kW type (mm)

Liquid pipe			Ø9,52				Ø12,70			Ø15,88	
Gas pipe			Ø19,05	Ø22,22	Ø25,40	Ø19,05	Ø22,22	Ø25,40	Ø19,05	Ø22,22	Ø25,40
PZH4	Type 200 ~ 250		✗	✗	✗	▽ 100 m (30 m)	Standard 100 m (30 m)	⊙ 100 m (30 m)	▽ 65 m (20 m)	□ 65 m (20 m)	□ 65 m (20 m)
Additional refrigerant charging amount per 1 m			✗	✗	✗	80 g/m	80 g/m	80 g/m	120 g/m	120 g/m	120 g/m

⊙ Allowable □ Limited piping length 50 m Maximum piping length
 ▽ Cooling capacity down ✗ Unallowable (50 m) Charge less piping length in a single connection

Table 3 - Deterioration Criteria for Refrigerant Oil

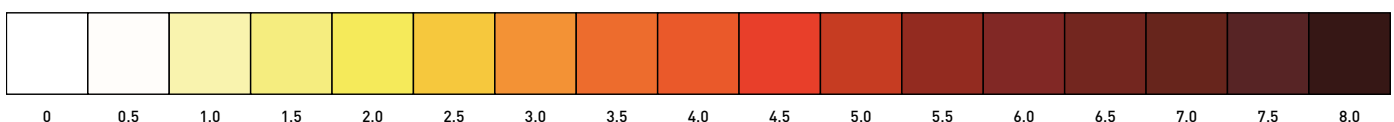

Accessories and control

Drain kits

Drain kit to suit outdoor units from 5,0 to 7,1 kW.

CZ-50DRS1

Drain kit to suit outdoor units from 10,0 to 25 kW.

CZ-140DRS1

Branch Pipes, Header



Branch pipe.

CZ-P224BK2BM



Branch pipe (from 22,4 kW to 68 kW).

CZ-P680BK2BM



Header.

CZ-P3HPC2BM

Special outdoor supports



Tray for condenser water compatible with outdoor elevation platform.

PAW-WTRAY



Outdoor elevation platform.

Dimension (HxWxD): 400x900x400 mm

PAW-GRDSTD40



Outdoor base ground support for noise and vibration absorption.

Dimension (HxWxD): 600x95x130 mm
Safe working load: 500 kg

PAW-GRDBSE20

Panels



Panel for 4 way 60x60 cassette - PY3.

CZ-KPY4



Standard panel for 4 way 90x90 cassette.

CZ-KPU3W



Econavi panel for 4 way 90x90 cassette.

CZ-KPU3AW

Sensors



Econavi energy saving sensor.

CZ-CENSC1



Remote temperature sensor.

CZ-CSRC3



Fresh air-intake kit

CZ-FDU3+CZ-ATU2

NEW IAQ filter for adaptive ducted unit



BION air pollutant filter for S-3650PF3E.

PAW-APF800F

BION air pollutant filter for S-6071PF3E.

PAW-APF1000F

BION air pollutant filter for S-1014PF3E.

PAW-APF1400F

Plenums

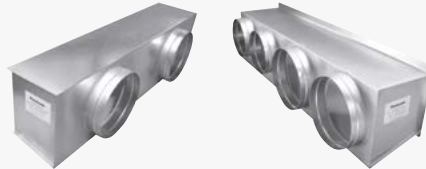

Air outlet plenum for S-3650PF3E.

CZ-56DAF2

Air outlet plenum for S-1014PF3E.

CZ-160DAF2

Air outlet plenum for S-200PE4E and S-200PE3E5B.

CZ-TREMIESPW705

Air outlet plenum for S-6071PF3E.

CZ-90DAF2

Air outlet plenum for S-250PE4E and S-250PE3E5B.

CZ-TREMIESPW706

VRF Smart Connectivity+



Remote controller Panasonic Net Con, RH, No PIR, R1/R2.

SER8150R0B1194

Remote controller Panasonic Net Con, RH, PIR, R1/R2.

SER8150R5B1194



Wireless ZigBee® Pro module / Green Com card.

VCM8000V5094P



Hotel room expansion module 14 indoor units.

HRCEP14R



Hotel room controller 28 indoor units.

HRCPBG28R

Hotel room controller w/Display 42 indoor units.

HRCPDG42R



Door/window wireless sensor.

SED-WDC-G-5045



Wall/ceiling motion/temperature/humidity sensor.

SED-MTH-G-5045



CO₂ sensor.

SED-CO2-G-5045









Sensor with room temperature and humidity.

SED-TRH-G-5045





Water leakage sensor.

SED-WLS-G-5045

 <p>Cover frame. Silver.</p> <p>----- FAS-00</p>	 <p>Cover frame. White.</p> <p>----- FAS-01</p>	 <p>Cover frame. Glossy translucent white.</p> <p>----- FAS-03</p>	 <p>Cover frame. Light tan wood.</p> <p>----- FAS-05</p>
 <p>Cover frame. Dark brown wood.</p> <p>----- FAS-06</p>	 <p>Cover frame. Dark black wood.</p> <p>----- FAS-07</p>	 <p>Cover frame. Brushed steel finish.</p> <p>----- FAS-10</p>	

Controller and touch controllers for hotels with dry contacts



 <p>Modbus RS-485 touch room controller with I/O, white.</p> <p>----- PAW-RE2C4-MOD-WH</p> <p>Touch display control with 2 digital inputs, white.</p> <p>----- PAW-RE2D4-WH</p>	 <p>Modbus RS-485 touch room controller with I/O, black.</p> <p>----- PAW-RE2C4-MOD-BK</p> <p>Touch display control with 2 digital inputs, black.</p> <p>----- PAW-RE2D4-BK</p>
--	---

Hotel sensors for dry contacts

 <p>Wall silent motion sensor 24 V.</p> <p>----- PAW-WMS-DC</p> <p>Wall silent motion sensor 240 V AC.</p> <p>----- PAW-WMS-AC</p>	 <p>Ceiling silent motion sensor 24 V.</p> <p>----- PAW-CMS-DC</p> <p>Ceiling silent motion sensor 240 V AC.</p> <p>----- PAW-CMS-AC</p>	 <p>Power supply 24 V.</p> <p>----- PAW-24DC</p>	 <p>Door or window contact.</p> <p>----- PAW-DWC</p>
---	---	---	--

Centralised controls

 <p>System controller for 64 indoor units with weekly timer.</p> <p>----- CZ-64ESMC3</p>	 <p>Central ON / OFF controller, up to 16 groups, 64 indoor units.</p> <p>----- CZ-ANC3</p>	 <p>Intelligent controller (touch screen/web server) to control up to 256 indoors with included load distribution ratio (LDR).</p> <p>----- CZ-256ESMC3</p>
--	---	---

Panasonic AC Smart Cloud



+ ALL REFERENCES RELATED TO AC SMART CLOUD IS IN THE DEDICATED PAGE

Panasonic AC Smart Cloud. Cloud internet control. Up to 128 groups. Controls 128 units.

CZ-CFUSCC1

NEW BMS interface with S-Link



A unified interface supporting Modbus, BACnet, and KNX protocols for up to 16 indoor units.

PAW-AC2-BMS-16

A unified interface supporting Modbus, BACnet, and KNX protocols for up to 64 indoor units.

PAW-AC2-BMS-64

A unified interface supporting Modbus, BACnet, and KNX protocols for up to 128 indoor units.

PAW-AC2-BMS-128

Accessories interfaces

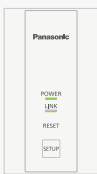

Commercial Wi-Fi Adaptor.

CZ-CAPWFC1



KNX interface (Intesis).

PAW-RC2-KNX-1i



Modbus RTU interface (Intesis).

PAW-RC2-MBS-1



Modbus RTU interface to control 4 indoor/groups (Intesis).

PAW-RC2-MBS-4



BACnet IP and MSTP (Intesis).

PAW-RC2-BAC-1



KNX interface (Airzone).

PAW-AZRC-KNX-1



Modbus RTU interface (Airzone).

PAW-AZRC-MBS-1



BACnet IP and MSTP interface (Airzone).

PAW-AZRC-BAC-1











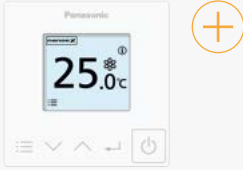

RAC interface adapter for integration into S-Link, plus external input and alarm/status output (for YKEA units).

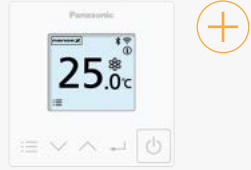
CZ-CAPRA1

Centralised controls. Connection with general equipment

 <p>Adaptor for ON / OFF control of external devices.</p> <p>----- CZ-CAPC3</p>	 <p>Demand control for PACi and Mini ECOi outdoor units.</p> <p>----- CZ-CAPDC3</p>	 <p>Mini series parallel device controlling indoor units, maximum 1 group and 8 indoor unit.</p> <p>----- CZ-CAPBC2</p>	 <p>Communication Adaptor. Up to 128 groups. Controls 128 units.</p> <p>----- CZ-CFUNC2</p>
---	---	--	---

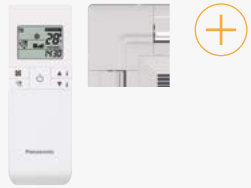
Individual controls

 <p>CONEX wired remote controller (non-wireless), white.</p> <p>----- CZ-RTC6W</p>	 <p>CONEX wired remote controller with Bluetooth®, white.</p> <p>----- CZ-RTC6WBL</p>	 <p>CONEX wired remote controller with Wi-Fi and Bluetooth®, white.</p> <p>----- CZ-RTC6WBLW</p>	 <p>CONEX wired remote controller (non-wireless), black.</p> <p>----- CZ-RTC6</p>
 <p>CONEX wired remote controller with Bluetooth®, black.</p> <p>----- CZ-RTC6BL</p>	 <p>CONEX wired remote controller with Wi-Fi and Bluetooth®, black.</p> <p>----- CZ-RTC6BLW</p>	 <p>Design wired remote controller with Econavi function and datanavi.</p> <p>----- CZ-RTC5B</p>	 <p>Infrared remote controller for wall-mounted.</p> <p>----- CZ-RWS3</p>
 <p>Infrared remote controller and receiver for 4 way 60x60 cassette - PY3 with panel.</p> <p>----- CZ-RWS3 + CZ-RWRY3</p>	 <p>Infrared remote controller and receiver for 4 way 90x90 cassette.</p> <p>----- CZ-RWS3 + CZ-RWRU3W</p>	 <p>Infrared remote controller and receiver for ceiling.</p> <p>----- CZ-RWS3 + CZ-RWRT3</p>	 <p>Infrared remote controller and receiver for all indoor units.</p> <p>----- CZ-RWS3 + CZ-RWRC3</p>

Accessories PCB



T10 interface PCB with digital and relay connections.

PAW-T10



PCB for server room application, control up to 4 indoor unit groups, redundancy, backup, etc.

PAW-PACR4



Connector to PACi NX indoor unit's PCB to provide OPT functions.

PAW-OPT-NX



Redundancy of 2 units YKEA.

PAW-SERVER-PKEA-1

Accessories cables

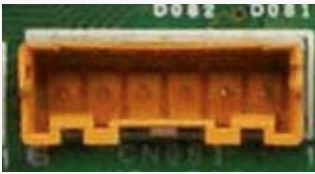

Cable for all the T10 functions.

CZ-T10



Cable to operate external EC fan.

PAW-FDC



Cable for all option monitoring signals.

PAW-OCT



Cable with force thermo OFF/leakage detection.

PAW-EXCT

Eurovent certified technical data

Panasonic's PACi and VRF systems are now certified by Eurovent*. The Eurovent certification verifies the performance ratings of heating and cooling systems following European standards. Data provides products efficiency with full transparency, for the benefit of customers and professionals.

Eurovent AC1 certified technical data: Wall-mounted Professional YKEA- R32

Kit			KIT-Z25-YKEA	KIT-Z35-YKEA	KIT-Z42-YKEA	KIT-Z50-YKEA	KIT-Z71-YKEA
Outdoor unit			CU-Z25YKEA	CU-Z35YKEA	CU-Z42YKEA	CU-Z50YKEA	CU-Z71YKEA
Indoor unit			CS-Z25YKEA	CS-Z35YKEA	CS-Z42YKEA	CS-Z50YKEA	CS-Z71YKEA
Seasonal efficiency in cooling (SEASC)	Pdesignc	kW	2,50	3,50	4,20	4,70	7,10
	SEER		9,50	9,60	8,60	8,60	6,50
	Qce	kWh/annum	92,00	128,00	171,00	191	382,00
Standard cooling PL Condition A (STD cooling)	Nominal cooling capacity (Pc)	kW	2,50	3,50	4,20	4,7	7,10
	Input power (Pec)	kW	0,51	0,85	1,10	1,12	2,20
	EER		4,90	4,12	3,82	4,2	3,23
Heating average climate (SEASHAvg)	Pdesignh	kW	2,70	3,20	3,60	4,20	5,50
	SCOP		4,60	4,60	4,50	4,60	4,10
	Qhe	kWh/annum	822,00	974,00	1120,00	1278,00	1878,00
Standard heating (STD heating)	Nominal heating capacity (Pc)	kW	3,40	4,00	5,30	5,80	8,20
	Input power (Peh)	kW	0,70	0,90	1,35	1,42	2,21
	COP		4,86	4,44	3,93	4,08	3,71
Acoustic (sound)	Lw0 env	dB(A)	61	63	64	63	66

Commercial air to air - PACi

Eurovent AC1 certified technical data: PACi NX Series Elite wall-mounted - PK3 · R32

Outdoor unit			U-36PZH3E5	U-50PZH3E5	U-60PZH3E5	U-71PZH4E5	U-71PZH4E8	U-100PZH4E5	U-100PZH4E8
Indoor unit			S-3650PK3E	S-3650PK3E	S-6010PK3E	S-6010PK3E	S-6010PK3E	S-6010PK3E	S-6010PK3E
Seasonal efficiency in cooling (SEASC)	Pdesignc	kW	3,60	5,00	6,10	7,10	7,10	9,50	9,50
	SEER		8,40	8,00	7,20	6,80	6,70	6,40	6,30
	Qce	kWh/annum	150,00	219,00	297,00	365,00	370,00	520,00	526,00
Standard cooling PL Condition A (STD cooling)	Nominal cooling capacity (Pc)	kW	3,60	5,00	6,10	7,10	7,10	9,50	9,50
	Input power (Pec)	kW	0,73	1,18	1,58	2,03	2,03	2,96	2,96
	EER		4,93	4,24	3,86	3,50	3,50	3,21	3,21
Heating average climate (SEASHAvg)	Pdesignh	kW	3,60	4,50	4,60	5,20	5,20	8,00	8,00
	SCOP		4,90	4,70	4,80	4,70	4,70	3,90	3,90
	Qhe	kWh/annum	1029,00	1341,00	1342,00	1549,00	1549,00	2871,00	2871,00
Standard heating (STD heating)	Nominal heating capacity (Pc)	kW	4,00	5,60	7,00	8,00	8,00	9,50	9,50
	Input power (Peh)	kW	0,83	1,35	1,67	2,00	2,00	2,45	2,45
	COP		4,82	4,15	4,19	4,00	4,00	3,88	3,88
Acoustic (sound)	Lw0 env	dB(A)	62	64	65	65	65	69	69

Eurovent AC1 certified technical data: PACi NX Series Elite 4 way 60x60 cassette - PY3 · R32

Outdoor unit			U-36PZH3	U-50PZH3	U-60PZH3
Indoor unit			S-36PY3E	S-50PY3E	S-60PY3E
Seasonal efficiency in cooling (SEASC)	Pdesignc	kW	3,60	4,7	6,00
	SEER		7,30	7,00	6,70
	Qce	kWh/annum	171,00	235	314,00
Standard cooling PL Condition A (STD cooling)	Nominal cooling capacity (Pc)	kW	3,60	4,7	6,00
	Input power (Pec)	kW	0,80	1,25	1,75
	EER		4,50	3,76	3,43
Heating average climate (SEASHAvg)	Pdesignh	kW	3,60	4,50	4,60
	SCOP		4,70	4,60	4,30
	Qhe	kWh/annum	1073,00	1370,00	1498,00
Standard heating (STD heating)	Nominal heating capacity (Pc)	kW	4,00	5,60	7,00
	Input power (Peh)	kW	0,97	1,66	2,06
	COP		4,12	3,37	3,40
Acoustic (sound)	Lw0 env	dB(A)	62	64	65

Eurovent AC1 certified technical data: PACi NX Series Elite 4 way 90x90 cassette - PU3 · R32

Outdoor unit			U-36PZH3E5	U-50PZH3E5	U-60PZH3E5	U-71PZH4E5	U-71PZH4E8	U-100PZH4E8	U-100PZH4E5
Indoor unit			S-3650PU3E	S-3650PU3E	S-6071PU3E	S-6071PU3E	S-6071PU3E	S-1014PU3E	S-1014PU3E
Seasonal efficiency in cooling (SEASC)	Pdesignc	kW	3,60	5,00	6,00	7,10	7,10	9,50	9,50
	SEER		8,90	8,60	8,00	7,70	7,70	7,80	7,80
	Qce	kWh/annum	142,00	203,00	263,00	323,00	323,00	426,00	426,00
Standard cooling PL Condition A (STD cooling)	Nominal cooling capacity (Pc)	kW	3,60	5,00	6,00	7,10	7,10	9,50	9,50
	Input power (Pec)	kW	0,66	1,16	1,48	1,75	1,75	2,15	2,15
	EER		5,45	4,31	4,05	4,06	4,06	4,42	4,42
Heating average climate (SEASHAvg)	Pdesignh	kW	3,60	4,50	4,70	5,20	5,20	8,00	8,00
	SCOP		5,10	4,90	4,80	4,80	4,80	4,90	4,90
	Qhe	kWh/annum	988,00	1286,00	1371,00	1517,00	1517,00	2286,00	2286,00
Standard heating (STD heating)	Nominal heating capacity (Pc)	kW	4,00	5,60	7,00	8,00	8,00	11,20	11,20
	Input power (Peh)	kW	0,74	1,32	1,74	1,86	1,86	2,24	2,24
	COP		5,41	4,24	4,02	4,30	4,30	5,00	5,00
Acoustic (sound)	Lw0 env	dB(A)	62	64	65	65	65	69	69

Eurovent AC1 certified technical data: PACi NX Series Elite ceiling - PT3 · R32

Outdoor unit			U-36PZH3E5	U-50PZH3E5	U-60PZH3E5	U-71PZH4E5	U-71PZH4E8	U-100PZH4E5	U-100PZH4E8
Indoor unit			S-3650PT3E	S-3650PT3E	S-6071PT3E	S-6071PT3E	S-6071PT3E	S-1014PT3E	S-1014PT3E
Seasonal efficiency in cooling (SEASC)	Pdesignc	kW	3,50	5,00	6,00	6,80	6,80	9,50	9,50
	SEER		7,70	7,40	7,50	7,30	7,20	7,30	7,20
	Qce	kWh/annum	160,00	237,00	280,00	326,00	331,00	456,00	462,00
Standard cooling PL Condition A (STD cooling)	Nominal cooling capacity (Pc)	kW	3,50	5,00	6,00	6,80	6,80	9,50	9,50
	Input power (Pec)	kW	0,72	1,24	1,57	1,74	1,74	2,34	2,34
	EER		4,86	4,03	3,82	3,91	3,91	4,06	4,06
Heating average climate (SEASHAvg)	Pdesignh	kW	3,10	4,00	4,60	4,70	4,70	7,80	7,80
	SCOP		4,90	4,80	4,80	4,70	4,70	4,50	4,50
	Qhe	kWh/annum	886,00	1167,00	1342,00	1400,00	1400,00	2426,00	2427,00
Standard heating (STD heating)	Nominal heating capacity (Pc)	kW	4,00	5,60	7,00	8,00	8,00	11,20	11,20
	Input power (Peh)	kW	0,80	1,39	1,69	2,02	2,02	2,80	2,80
	COP		5,00	4,03	4,14	3,96	3,96	4,00	4,00
Acoustic (sound)	Lw0 env	dB(A)	62	64	65	65	65	69	69

Eurovent AC1 certified technical data: PACi NX Series Elite adaptive ducted unit - PF3 · R32

Outdoor unit			U-36PZH3E5	U-50PZH3E5	U-60PZH3E5	U-71PZH4E5	U-71PZH4E8	U-100PZH4E5	U-100PZH4E8
Indoor unit			S-3650PF3E	S-3650PF3E	S-6071PF3E	S-6071PF3E	S-6071PF3E	S-1014PF3E	S-1014PF3E
Seasonal efficiency in cooling (SEASC)	Pdesignc	kW	3,60	5,00	5,70	6,80	6,80	9,50	9,50
	SEER		6,80	6,10	7,10	7,10	7,10	7,40	7,40
	Qce	kWh/annum	185,00	287,00	281,00	332,00	332,00	447,00	447,00
Standard cooling PL Condition A (STD cooling)	Nominal cooling capacity (Pc)	kW	3,60	5,00	5,70	6,80	6,80	9,50	9,50
	Input power (Pec)	kW	0,85	1,46	1,55	1,82	1,82	2,32	2,32
	EER		4,24	3,42	3,68	3,74	3,74	4,09	4,09
Heating average climate (SEASHAvg)	Pdesignh	kW	3,60	4,00	4,70	4,70	4,70	7,80	7,80
	SCOP		4,50	4,20	4,40	4,70	4,70	4,30	4,30
	Qhe	kWh/annum	1120,00	1333,00	1495,00	1393,00	1394,00	2540,00	2540,00
Standard heating (STD heating)	Nominal heating capacity (Pc)	kW	4,00	5,60	7,00	7,50	7,50	10,80	10,80
	Input power (Peh)	kW	0,96	1,55	1,87	1,86	1,86	2,78	2,78
	COP		4,17	3,61	3,74	4,03	4,03	3,88	3,88
Acoustic (sound)	Lw0 env	dB(A)	62	64	65	65	65	69	69

Eurovent certified technical data

Commercial air to air - PACi

Eurovent AC1 certified technical data: PACi NX Series Standard wall-mounted - PK3 - R32

Outdoor unit			U-36PZ3E5	U-50PZ3E5	U-60PZ3E5A	U-71PZ3E5A	U-100PZ3E5	U-100PZ3E8
Indoor unit			S-3650PK3E	S-3650PK3E	S-6010PK3E	S-6010PK3E	S-6010PK3E	S-6010PK3E
Seasonal efficiency in cooling (SEASC)	Pdesignc	kW	3,60	5,00	6,10	7,10	9,00	9,00
	SEER		7,60	7,40	7,00	5,80	6,50	6,50
	Qce	kWh/annum	166,00	237,00	305,00	429,00	485,00	485,00
Standard cooling PL Condition A (STD cooling)	Nominal cooling capacity (Pc)	kW	3,60	5,00	6,10	7,10	9,00	9,00
	Input power (Pec)	kW	0,87	1,42	1,66	2,25	2,59	2,59
	EER		4,14	3,52	3,67	3,16	3,47	3,47
Heating average climate (SEASHAvg)	Pdesignh	kW	2,80	4,00	4,60	5,20	9,00	9,00
	SCOP		4,50	4,40	4,70	4,40	3,90	3,90
	Qhe	kWh/annum	872,00	1273,00	1370,00	1653,00	3231,00	3231,00
Standard heating (STD heating)	Nominal heating capacity (Pc)	kW	3,60	5,00	6,10	7,10	9,00	9,00
	Input power (Peh)	kW	0,78	1,19	1,39	1,68	2,29	2,29
	COP		4,62	4,20	4,39	4,23	3,93	3,93
Acoustic (sound)	Lw0 env	dB(A)	64	64	64	66	70	70

Eurovent AC1 certified technical data: PACi NX Series Standard 4 way 60x60 cassette - PY3 - R32

Outdoor unit			U-25PZ3	U-36PZ3	U-50PZ3	U-60PZ3E
Indoor unit			S-25PY3E	S-36PY3E	S-50PY3E	S-60PY3E
Seasonal efficiency in cooling (SEASC)	Pdesignc	kW	2,50	3,60	4,7	6,00
	SEER		6,50	6,70	7,30	6,80
	Qce	kWh/annum	134,00	188,00	226	305,00
Standard cooling PL Condition A (STD cooling)	Nominal cooling capacity (Pc)	kW	2,50	3,60	4,7	6,00
	Input power (Pec)	kW	0,56	0,91	1,34	1,77
	EER		4,46	3,96	3,51	3,39
Heating average climate (SEASHAvg)	Pdesignh	kW	2,80	2,80	4,00	4,60
	SCOP		4,60	4,30	4,40	4,20
	Qhe	kWh/annum	850,00	912,00	1264,00	1500,00
Standard heating (STD heating)	Nominal heating capacity (Pc)	kW	3,20	3,60	5,00	6,00
	Input power (Peh)	kW	0,72	0,84	1,27	1,66
	COP		4,44	4,29	3,94	3,61
Acoustic (sound)	Lw0 env	dB(A)	64	64	64	64

Eurovent AC1 certified technical data: PACi NX Series Standard 4 way 90x90 cassette - PU3 - R32

Outdoor unit			U-36PZ3E5	U-50PZ3E5	U-60PZ3E5A	U-71PZ3E5A	U-100PZ3E5	U-100PZ3E8
Indoor unit			S-3650PU3E	S-3650PU3E	S-6071PU3E	S-6071PU3E	S-1014PU3E	S-1014PU3E
Seasonal efficiency in cooling (SEASC)	Pdesignc	kW	3,60	5,00	6,00	7,10	10,00	10,00
	SEER		8,10	8,00	7,80	6,80	6,80	6,70
	Qce	kWh/annum	156,00	219,00	269,00	365,00	515,00	521,00
Standard cooling PL Condition A (STD cooling)	Nominal cooling capacity (Pc)	kW	3,60	5,00	6,00	7,10	10,00	10,00
	Input power (Pec)	kW	0,83	1,28	1,61	2,17	2,62	2,62
	EER		4,34	3,91	3,73	3,27	3,82	3,82
Heating average climate (SEASHAvg)	Pdesignh	kW	2,80	4,00	4,60	5,20	10,00	10,00
	SCOP		4,80	4,70	4,90	4,60	4,40	4,40
	Qhe	kWh/annum	817,00	1191,00	1314,00	1583,00	3182,00	3182,00
Standard heating (STD heating)	Nominal heating capacity (Pc)	kW	3,60	5,00	6,00	7,10	10,00	10,00
	Input power (Peh)	kW	0,71	1,08	1,34	1,68	2,03	2,03
	COP		5,07	4,63	4,48	4,23	4,93	4,93
Acoustic (sound)	Lw0 env	dB(A)	64	64	64	66	70	70

Eurovent AC1 certified technical data: PACi NX Series Standard ceiling - PT3 - R32

Outdoor unit			U-36PZ3E5	U-50PZ3E5	U-60PZ3E5A	U-71PZ3E5A	U-100PZ3E5	U-100PZ3E8
Indoor unit			S-3650PT3E	S-3650PT3E	S-6071PT3E	S-6071PT3E	S-1014PT3E	S-1014PT3E
Seasonal efficiency in cooling (SEASC)	Pdesignc	kW	3,50	5,00	6,00	6,80	10,00	10,00
	SEER		7,20	6,70	7,30	5,90	6,60	6,50
	Qce	kWh/annum	171,00	262,00	288,00	404,00	531,00	537,00
Standard cooling PL Condition A (STD cooling)	Nominal cooling capacity (Pc)	kW	3,50	5,00	6,00	6,80	10,00	10,00
	Input power (Pec)	kW	0,85	1,65	1,67	2,10	2,75	2,75
	EER		4,14	3,03	3,59	3,24	3,64	3,64
Heating average climate (SEASHAvg)	Pdesignh	kW	2,80	4,00	4,60	4,70	10,00	10,00
	SCOP		4,40	4,10	4,60	4,30	4,20	4,20
	Qhe	kWh/annum	891,00	1365,00	1399,00	1529,00	3331,00	3331,00
Standard heating (STD heating)	Nominal heating capacity (Pc)	kW	3,50	5,00	6,00	6,80	10,00	10,00
	Input power (Peh)	kW	0,76	1,34	1,46	1,62	2,36	2,36
	COP		4,61	3,73	4,11	4,20	4,24	4,24
Acoustic (sound)	Lw0 env	dB(A)	64	64	64	66	70	70

Eurovent AC1 certified technical data: PACi NX Series Standard adaptive ducted unit - PF3 - R32

Outdoor unit			U-36PZ3E5	U-50PZ3E5	U-60PZ3E5A	U-71PZ3E5A	U-100PZ3E5	U-100PZ3E8
Indoor unit			S-3650PF3E	S-3650PF3E	S-6071PF3E	S-6071PF3E	S-1014PF3E	S-1014PF3E
Seasonal efficiency in cooling (SEASC)	Pdesignc	kW	3,40	5,00	5,70	6,80	9,50	9,50
	SEER		6,00	6,50	6,40	6,00	6,60	6,50
	Qce	kWh/annum	198,00	267,00	310,00	391,00	502,00	508,00
Standard cooling PL Condition A (STD cooling)	Nominal cooling capacity (Pc)	kW	3,40	5,00	5,70	6,80	9,50	9,50
	Input power (Pec)	kW	0,90	1,80	1,61	2,14	2,66	2,66
	EER		3,78	2,78	3,54	3,18	3,57	3,57
Heating average climate (SEASHAvg)	Pdesignh	kW	2,40	3,80	4,40	4,70	7,80	7,80
	SCOP		4,00	4,00	4,40	4,10	3,90	3,90
	Qhe	kWh/annum	839,00	1303,00	1376,00	1591,00	2795,00	2795,00
Standard heating (STD heating)	Nominal heating capacity (Pc)	kW	3,40	5,00	5,70	6,80	9,50	9,50
	Input power (Peh)	kW	0,82	1,38	1,41	1,70	2,32	2,32
	COP		4,15	3,62	4,04	4,00	4,09	4,09
Acoustic (sound)	Lw0 env	dB(A)	64	64	64	66	70	70